

# FCC REPORT

## (LTE)

**Applicant:** SKY PHONE LLC

**Address of Applicant:** 1348 Washington Av. Suite 350, Miami Beach, FL33139

**Equipment Under Test (EUT)**

Product Name: SMART PHONE

Model No.: SKY BLACK

Trade mark: SKY DEVICES

**FCC ID:** 2ABOSSKYBLACK

**Applicable standards:** FCC CFR Title 47 Part 2  
FCC CFR Title 47 Part 22 Subpart H  
FCC CFR Title 47 Part 27 Subpart L  
FCC CFR Title 47 Part 27 Subpart M

**Date of sample receipt:** 17 Sep., 2019

**Date of Test:** 18 Sep., to 24 Oct., 2019

**Date of report issued:** 25 Oct., 2019

**Test Result:** PASS\*

\*In the configuration tested, the EUT complied with the standards specified above.

Authorized Signature:



Bruce Zhang  
Laboratory Manager

This report details the results of the testing carried out on one sample. The results contained in this test report do not relate to other samples of the same product and does not permit the use of the CCIS product certification mark. The manufacturer should ensure that all products in series production are in conformity with the product sample detailed in this report.

This report may only be reproduced and distributed in full. If the product in this report is used in any configuration other than that detailed in the report, the manufacturer must ensure the new system complies with all relevant standards.

This document cannot be reproduced except in full, without prior written approval of the Company. Any unauthorized alteration, forgery or falsification of the content or appearance of this document is unlawful, and offenders may be prosecuted to the fullest extent of the law. Unless otherwise stated the results shown in this test report refer only to the sample(s) tested and such sample(s) are retained for 90 days only.

## 2. Version

Version No.	Date	Description
00	25 Oct., 2019	Original

**Tested by:**

YT Yang  
Test Engineer

**Date:**

25 Oct., 2019

**Reviewed by:**

Winner Zhang  
Project Engineer

**Date:**

25 Oct., 2019

## 3. Contents

	Page
<b>1. COVER PAGE</b> .....	<b>1</b>
<b>2. VERSION</b> .....	<b>2</b>
<b>3. CONTENTS</b> .....	<b>3</b>
<b>4. TEST SUMMARY</b> .....	<b>4</b>
<b>5. GENERAL INFORMATION</b> .....	<b>5</b>
5.1 CLIENT INFORMATION.....	5
5.2 GENERAL DESCRIPTION OF E.U.T.....	5
5.3 TEST ENVIRONMENT AND MODE.....	9
5.4 DESCRIPTION OF SUPPORT UNITS.....	9
5.5 MEASUREMENT UNCERTAINTY.....	9
5.6 RELATED SUBMITTAL(S) / GRANT (S).....	9
5.7 ADDITIONS TO, DEVIATIONS, OR EXCLUSIONS FROM THE METHOD.....	9
5.8 LABORATORY FACILITY.....	9
5.9 LABORATORY LOCATION.....	10
5.10 TEST INSTRUMENTS LIST.....	10
<b>6. TEST RESULTS</b> .....	<b>11</b>
6.1 CONDUCTED OUTPUT POWER, ERP AND EIRP.....	11
6.2 PEAK-TO-AVERAGE RATIO.....	19
6.3 OCCUPY BANDWIDTH.....	22
6.4 OUT OF BAND EMISSION AT ANTENNA TERMINALS.....	54
6.5 FIELD STRENGTH OF SPURIOUS RADIATION MEASUREMENT.....	139
6.6 FREQUENCY STABILITY V.S. TEMPERATURE MEASUREMENT.....	154
6.7 FREQUENCY STABILITY V.S. VOLTAGE MEASUREMENT.....	158
<b>7 TEST SETUP PHOTO</b> .....	<b>160</b>
<b>8 EUT CONSTRUCTIONAL DETAILS</b> .....	<b>161</b>

## 4. Test Summary

Test Items	Section in CFR 47	Result
RF Exposure (SAR)	Part 1.1307 Part 2.1093	Passed (Please refer to SAR Report)
RF Output Power	Part 2.1046 Part 22.913 (a)(2) Part 27.50 (d)(4) Part 27.50 (h)(2)	Pass
Peak-to-Average Ratio	Part 24.232 (d) Part 27.50(d)(5)	Pass
Modulation Characteristics	Part 2.1047	Pass
99% & -26 dB Occupied Bandwidth	Part 2.1049 Part 22.917(b) Part 27.53(h) Part 27.53(m)	Pass
Out of band emission at antenna terminals	Part 2.1053 Part 22.917(a) Part 27.53 (h) Part 27.53(m)	Pass
Field strength of spurious radiation	Part 2.1053 Part 22.917(a) Part 27.53 (h) Part 27.53(m)	Pass
Frequency stability vs. temperature	Part 22.355 Part 24.235 Part 27.54 Part 2.1055(a)(1)(b)	Pass
Frequency stability vs. voltage	Part 22.355 Part 24.235 Part 27.54 Part 2.1055(d)(2)	Pass
<p><b>Remark:</b></p> <ol style="list-style-type: none"> <li>1. Pass: The EUT complies with the essential requirements in the standard.</li> <li>2. The cable insertion loss used by "RF Output Power" and other conduction measurement items is 0.5dB (provided by the customer).</li> </ol>		
<b>Test Method:</b>	ANSI/TIA-603-E-2016 ANSI C63.26-2015	

## 5. General Information

### 5.1 Client Information

Applicant:	SKY PHONE LLC
Address:	1348 Washington Av. Suite 350, Miami Beach, FL33139
Manufacturer:	SKY PHONE LLC
Address:	1348 Washington Av. Suite 350, Miami Beach, FL33139
Factory:	Gui zhou Fortuneship Technology Co., Ltd
Address:	No. 4 Plant, High-tech Industrial Park, Xinpu Economic Development Zone) Jingkai Road, Xinpu Jingkai District, Xinpu New District, Zunyi City, Guizhou Province, P. R. China

### 5.2 General Description of E.U.T.

Product Name:	SMART PHONE
Model No.:	SKY BLACK
Operation Frequency range:	LTE Band 4: TX: 1710MHz-1755MHz, RX: 2110MHz-2155MHz LTE Band 5: TX: 824MHz-849MHz, RX: 869MHz-894MHz LTE Band 7: TX: 2500MHz-2570MHz, RX: 2620MHz-2690MHz
Modulation type:	QPSK, 16QAM
Antenna type:	Internal Antenna
Antenna gain:	LTE Band 4: -0.7 dBi LTE Band 5: -1.5 dBi LTE Band 7: 0.27 dBi
Power supply:	Rechargeable Li-ion Battery DC3.7V, 1400mAh
AC adapter:	Input: AC100-240V, 50/60Hz, 0.15A Output: DC 5.0V, 0.5A
Test Sample Condition:	The applicant provided engineering samples for staying in continuously transmitting for testing.

**Operation Frequency List:**

LTE Band 4 (1.4MHz)		LTE Band 4 (3MHz)	
Channel	Frequency (MHz)	Channel	Frequency (MHz)
19957	1710.70	19965	1711.50
19958	1710.80	19966	1711.60
....	....	....	....
20174	1732.40	20174	1732.40
20175	1732.50	20175	1732.50
20176	1732.60	20176	1732.60
...	...	...	...
20392	1754.20	20384	1753.40
20393	1754.30	20385	1753.50
LTE Band 4 (5MHz)		LTE Band 4 (10MHz)	
Channel	Frequency (MHz)	Channel	Frequency (MHz)
19975	1712.50	20000	1715.00
19976	1712.60	20001	1715.10
....	....	....	....
20174	1732.40	20174	1732.40
20175	1732.50	20175	1732.50
20176	1732.60	20176	1732.60
...	...	...	...
20374	1752.40	20349	1749.90
20375	1752.50	20350	1750.00
LTE Band 4 (15MHz)		LTE Band 4 (20MHz)	
Channel	Frequency (MHz)	Channel	Frequency (MHz)
20025	1717.50	20050	1720.00
20026	1717.60	20051	1720.10
....	....	....	....
20174	1732.40	20174	1732.40
20175	1732.50	20175	1732.50
20176	1732.60	20176	1732.60
...	...	...	...
20324	1747.40	20299	1744.90
20325	1747.50	20300	1745.00

LTE Band 5 (1.4MHz)		LTE Band 5 (3MHz)	
Channel	Frequency (MHz)	Channel	Frequency (MHz)
20407	824.70	20415	825.50
20408	824.80	20416	825.60
....	....	....	....
20524	836.40	20524	836.40
20525	836.50	20525	836.50
20526	836.60	20526	836.60
...	...	...	...
20642	848.20	20634	847.40
20643	848.30	20635	847.50
LTE Band 5 (5MHz)		LTE Band 5 (10MHz)	
Channel	Frequency (MHz)	Channel	Frequency (MHz)
20425	826.50	20450	829.00
20426	826.60	20451	829.10
....	....	....	....
20524	836.40	20524	836.40
20525	836.50	20525	836.50
20526	836.60	20526	836.60
...	...	...	...
20624	846.40	20599	839.90
20625	846.50	20600	844.00

LTE Band 7 (5MHz)		LTE Band 7 (10MHz)	
Channel	Frequency (MHz)	Channel	Frequency (MHz)
20775	2502.50	20800	2505.00
20776	2502.60	20801	2502.10
....	....	....	....
21099	2534.90	21099	2534.90
21100	2535.00	21100	2535.00
21101	2535.20	21101	2535.20
...	...	...	...
21424	2567.40	21399	2564.90
21425	2567.50	21400	2565.00
LTE Band 7 (15MHz)		LTE Band 7 (20MHz)	
Channel	Frequency (MHz)	Channel	Frequency (MHz)
20825	2507.50	20850	2510.00
20826	2507.60	20851	2510.10
....	....	....	....
21099	2534.90	21099	2534.90
21100	2535.00	21100	2535.00
21101	2535.20	21101	2535.20
...	...	...	...
21374	2562.40	21349	2559.90
21375	2562.50	21350	2560.00

Regards to the operating frequency range, the lowest frequency, the middle frequency, and the highest frequency of channel were selected to perform the test, and the selected channels as below:

LTE Band 4 (1.4MHz)			LTE Band 4 (3MHz)		
Channel:	Frequency (MHz)		Channel	Frequency (MHz)	
Lowest channel	19957	1710.70	Lowest channel	19965	1711.50
Middle channel	20175	1732.50	Middle channel	20175	1732.50
Highest channel	20393	1754.30	Highest channel	20385	1753.50
LTE Band 4 (5MHz)			LTE Band 4 (10MHz)		
Channel	Frequency (MHz)		Channel	Frequency (MHz)	
Lowest channel	19975	1712.50	Lowest channel	20000	1715.00
Middle channel	20175	1732.50	Middle channel	20175	1732.50
Highest channel	20375	1752.50	Highest channel	20350	1750.00
LTE Band 4 (15MHz)			LTE Band 4 (20MHz)		
Channel	Frequency (MHz)		Channel	Frequency (MHz)	
Lowest channel	20025	1717.50	Lowest channel	20050	1720.00
Middle channel	20175	1732.50	Middle channel	20175	1732.50
Highest channel	20325	1747.50	Highest channel	20300	1745.00

LTE Band 5 (1.4MHz)			LTE Band 5 (3MHz)		
Channel:	Frequency (MHz)		Channel	Frequency (MHz)	
Lowest channel	20407	824.70	Lowest channel	20415	825.50
Middle channel	20525	836.50	Middle channel	20525	836.50
Highest channel	20643	848.30	Highest channel	20635	847.50
LTE Band 5 (5MHz)			LTE Band 5 (10MHz)		
Channel	Frequency (MHz)		Channel	Frequency (MHz)	
Lowest channel	20425	826.50	Lowest channel	20450	829.00
Middle channel	20525	836.50	Middle channel	20525	836.50
Highest channel	20625	846.50	Highest channel	20600	844.00

LTE Band 7 (5MHz)			LTE Band 7 (10MHz)		
Channel	Frequency (MHz)		Channel	Frequency (MHz)	
Lowest channel	20775	2502.50	Lowest channel	20800	2505.00
Middle channel	21100	2535.00	Middle channel	21100	2535.00
Highest channel	21425	2567.50	Highest channel	21400	2565.00
LTE Band 7 (15MHz)			LTE Band 7 (20MHz)		
Channel	Frequency (MHz)		Channel	Frequency (MHz)	
Lowest channel	20825	2507.50	Lowest channel	20850	2510.00
Middle channel	21100	2535.00	Middle channel	21100	2535.00
Highest channel	21375	2562.50	Highest channel	21350	2560.00



### 5.3 Test environment and mode

Operating Environment:	
Temperature:	Normal: 15°C ~ 35°C, Extreme: -30°C ~ +50°C
Humidity:	20 % ~ 75 % RH
Atmospheric Pressure:	1008 mbar
Voltage:	Nominal: 3.7Vdc, Extreme: Low 3.5Vdc, High 4.2Vdc
Test mode:	
LTE QPSK mode	Keep the EUT communication with simulated station in QPSK mode
LTE 16-QAM mode	Keep the EUT communication with simulated station in 16-QAM mode
Remark: The EUT has been tested under continuous transmitting mode. Channel Low, Mid and High for each type band with rated data rate were chosen for full testing. The field strength of spurious radiation emission was measured as EUT stand-up position (H mode) and lie down position (E1, E2 mode) for these modes with power adaptor, earphone and Data cable. Just the worst case position (H mode) shown in report.	

### 5.4 Description of Support Units

Test Equipment	Manufacturer	Model No.	Serial No.
Simulated Station	Anritsu	MT8820C	6201026545

### 5.5 Measurement Uncertainty

Parameters	Expanded Uncertainty
Radiated Emission (9kHz ~ 30MHz)	±3.12 dB (k=2)
Radiated Emission (30MHz ~ 1000MHz)	±4.32 dB (k=2)
Radiated Emission (1GHz ~ 18GHz)	±5.38 dB (k=2)
Radiated Emission (18GHz ~ 40GHz)	±3.36 dB (k=2)

### 5.6 Related Submittal(s) / Grant (s)

This is an original grant, no related submittals and grants.
--

### 5.7 Additions to, deviations, or exclusions from the method

No
----

### 5.8 Laboratory Facility

<p>The test facility is recognized, certified, or accredited by the following organizations:</p> <ul style="list-style-type: none"> <li>● <b>FCC - Designation No.: CN1211</b> Shenzhen Zhongjian Nanfang Testing Co., Ltd. has been accredited as a testing laboratory by FCC (Federal Communications Commission). The test firm Registration No. is 727551.</li> <li>● <b>ISED – CAB identifier.: CN0021</b> The 3m Semi-anechoic chamber of Shenzhen Zhongjian Nanfang Testing Co., Ltd. has been Registered by Certification and Engineering Bureau of Industry Canada for radio equipment testing with Registration No.: 10106A-1.</li> <li>● <b>CNAS - Registration No.: CNAS L6048</b> Shenzhen Zhongjian Nanfang Testing Co., Ltd. is accredited to ISO/IEC 17025:2005 General Requirements for the Competence of Testing and Calibration laboratories for the competence of testing. The Registration No. is CNAS L6048.</li> <li>● <b>A2LA - Registration No.: 4346.01</b> This laboratory is accredited in accordance with the recognized International Standard ISO/IEC 17025:2005 General requirements for the competence of testing and calibration laboratories. The test scope can be found as below link: <a href="https://portal.a2la.org/scopepdf/4346-01.pdf">https://portal.a2la.org/scopepdf/4346-01.pdf</a></li> </ul>
---

### 5.9 Laboratory Location

Shenzhen Zhongjian Nanfang Testing Co., Ltd.  
 Address: No. B-C, 1/F., Building 2, Laodong No.2 Industrial Park, Xixiang Road,  
 Bao'an District, Shenzhen, Guangdong, China  
 Tel: +86-755-23118282, Fax: +86-755-23116366  
 Email: info@ccis-cb.com, Website: <http://www.ccis-cb.com>

### 5.10 Test Instruments list

Test Equipment	Manufacturer	Model No.	Serial No.	Cal. Date (mm-dd-yy)	Cal. Due date (mm-dd-yy)
3m SAC	SAEMC	9m*6m*6m	966	07-22-2017	07-21-2020
BiConiLog Antenna	SCHWARZBECK	VULB9163	497	03-18-2019	03-17-2020
Biconical Antenna	SCHWARZBECK	VUBA9117	359	06-22-2017	06-21-2020
Horn Antenna	SCHWARZBECK	BBHA9120D	916	03-18-2019	03-17-2020
Horn Antenna	SCHWARZBECK	BBHA9120D	1805	06-22-2017	06-21-2020
Horn Antenna	SCHWARZBECK	BBHA 9170	BBHA9170582	11-21-2018	11-20-2019
EMI Test Software	AUDIX	E3	Version: 6.110919b		
Pre-amplifier	HP	8447D	2944A09358	03-18-2019	03-17-2020
Pre-amplifier	CD	PAP-1G18	11804	03-18-2019	03-17-2020
Spectrum analyzer	Rohde & Schwarz	FSP30	101454	03-18-2019	03-17-2020
EMI Test Receiver	Rohde & Schwarz	ESRP7	101070	03-18-2019	03-17-2020
Spectrum Analyzer	Agilent	N9020A	MY50510123	10-29-2018	10-28-2019
Signal Generator	Rohde & Schwarz	SMX	835454/016	03-18-2019	03-17-2020
Signal Generator	R&S	SMR20	1008100050	03-18-2019	03-17-2020
RF Switch Unit	MWRFTST	MW200	N/A	N/A	N/A
Test Software	MWRFTST	MTS8200	Version: 2.0.0.0		
Cable	ZDECL	Z108-NJ-NJ-81	1608458	03-18-2019	03-17-2020
Cable	MICRO-COAX	MFR64639	K10742-5	03-18-2019	03-17-2020
Cable	SUHNER	SUCOFLEX100	58193/4PE	03-18-2019	03-17-2020
DC Power Supply	XinNuoEr	WYK-10020K	1409050110020	10-31-2018	10-30-2019
Temperature Humidity Chamber	HengPu	HPGDS-500	20140828008	09-24-2018	09-23-2019
				09-24-2019	09-23-2020
Simulated Station	Rohde & Schwarz	CMW500	140493	07-16-2019	07-15-2020

## 6. Test results

### 6.1 Conducted Output Power, ERP and EIRP

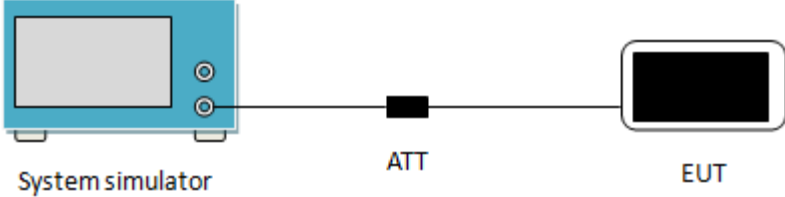
Test Requirement:	Part 22.913(a)(2), Part 27.50(d)(4), Part 27.50 (h)(2)
Limit:	LTE Band 4: 1W, LTE Band 5: 7W, LTE Band 7: 2W
Test Setup:	 <p>The diagram illustrates the test setup. On the left is a blue 'System simulator' with a screen and two ports. A cable connects one of its ports to a black 'ATT' (attenuator). Another cable connects the other side of the 'ATT' to a black 'EUT' (Equipment Under Test) which has a screen.</p>
Test Procedure:	The transmitter output was connected to a calibrated attenuator, the other end of which was connected to the CMW500. Transmitter output power was read off in dBm.
Test Instruments:	Refer to section 5.10 for details
Test mode:	Refer to section 5.3 for details
Test results:	Passed

**Measurement Data:**

LTE Band	Bandwidth (MHz)	Modulation	RB Size	RB Offset	Average Power (dBm)				
					19957	20175	20393		
					1710.7MHz	1732.5MHz	1754.3MHz		
4	1.4	QPSK	1	0	23.02	23.12	22.78		
			1	2	23.01	23.02	22.89		
			1	5	22.99	23.01	22.98		
			3	0	22.15	22.27	22.21		
			3	1	22.10	22.30	22.31		
			3	2	22.17	22.23	22.24		
			6	0	22.12	22.08	22.14		
		Antenna Gain (dBi):					-0.7		
		Max. EIRP (dBm):					22.42		
		EIRP Limit (dBm):					30.00		
		16QAM	1	0	22.70	22.41	22.44		
			1	2	22.28	22.31	22.31		
			1	5	22.31	22.35	22.44		
			3	0	21.31	21.21	21.20		
			3	1	21.35	21.14	21.31		
			3	2	21.48	21.29	21.24		
			6	0	21.16	21.34	21.05		
		Antenna Gain (dBi):					-0.7		
		Max. EIRP (dBm):					22.00		
		EIRP Limit (dBm):					30.00		
		LTE Band	Bandwidth (MHz)	Modulation	RB Size	RB Offset	Average Power (dBm)		
19965	20175						20385		
1711.5MHz	1732.5MHz						1753.5MHz		
4	3	QPSK	1	0	23.01	23.15	22.85		
			1	7	23.12	23.06	22.97		
			1	14	22.98	23.05	22.85		
			8	0	22.14	21.99	22.07		
			8	4	22.06	21.98	22.12		
			8	7	22.08	21.94	21.98		
			15	0	22.01	21.98	22.07		
		Antenna Gain (dBi):					-0.7		
		Max. EIRP (dBm):					22.45		
		EIRP Limit (dBm):					30.00		
		16QAM	1	0	22.41	22.32	21.96		
			1	7	22.39	22.33	22.20		
			1	14	22.41	22.14	22.04		
			8	0	21.12	21.05	21.24		
			8	4	21.15	21.07	21.04		
			8	7	21.35	21.03	21.13		
			15	0	21.16	21.24	21.18		
		Antenna Gain (dBi):					-0.7		
		Max. EIRP (dBm):					21.71		
		EIRP Limit (dBm):					30.00		
		<i>Note: EIRP (dBm) = Average power (dBm) + Antenna Gain (dBi).</i>							

LTE Band	Bandwidth (MHz)	Modulation	RB Size	RB Offset	Average Power (dBm)				
					19975	20175	20375		
					1712.5MHz	1732.5MHz	1752.5MHz		
4	5	QPSK	1	0	23.12	23.10	22.85		
			1	12	23.01	23.05	22.87		
			1	24	23.05	23.09	22.89		
			12	0	22.15	21.95	22.17		
			12	6	22.12	22.07	22.13		
			12	11	22.11	22.01	22.01		
			25	0	22.13	22.10	22.05		
		Antenna Gain (dBi):					-0.7		
		Max. EIRP (dBm):					22.42		
		EIRP Limit (dBm):					30.00		
		16QAM	1	0	22.45	22.16	22.34		
			1	12	22.52	22.32	22.05		
			1	24	22.42	21.98	21.98		
			12	0	21.34	21.24	21.22		
			12	6	21.32	21.17	21.03		
			12	11	21.52	21.07	20.99		
			25	0	21.27	21.26	21.12		
		Antenna Gain (dBi):					-0.7		
		Max. EIRP (dBm):					21.82		
		EIRP Limit (dBm):					30.00		
		LTE Band	Bandwidth (MHz)	Modulation	RB Size	RB Offset	Average Power (dBm)		
20000	20175						20350		
1715.0MHz	1732.5MHz						1750.0MHz		
4	10	QPSK	1	0	23.12	23.12	23.12		
			1	24	23.02	23.06	23.09		
			1	49	22.98	23.01	23.05		
			25	0	22.10	22.12	22.32		
			25	12	22.12	22.20	22.06		
			25	24	22.06	22.09	22.10		
			50	0	22.17	22.01	22.05		
		Antenna Gain (dBi):					-0.7		
		Max. EIRP (dBm):					22.42		
		EIRP Limit (dBm):					30.00		
		16QAM	1	0	22.62	22.45	21.84		
			1	24	22.13	22.10	22.08		
			1	49	22.32	22.13	21.89		
			25	0	21.54	21.32	21.35		
			25	12	21.46	21.31	21.29		
			25	24	21.33	21.29	21.27		
			50	0	21.20	21.12	21.36		
		Antenna Gain (dBi):					-0.7		
		Max. EIRP (dBm):					21.92		
		EIRP Limit (dBm):					30.00		
		Note: EIRP (dBm) = Average power (dBm) + Antenna Gain (dBi).							

LTE Band	Bandwidth (MHz)	Modulation	RB Size	RB Offset	Average Power (dBm)				
					20025	20175	20325		
					1717.5MHz	1732.5MHz	1747.5MHz		
4	15	QPSK	1	0	23.12	23.05	23.12		
			1	37	23.05	23.01	22.98		
			1	74	23.06	23.06	22.86		
			36	0	22.34	22.14	22.20		
			36	16	22.12	22.08	22.13		
			36	35	22.06	22.03	22.13		
			75	0	21.98	22.12	22.21		
		Antenna Gain (dBi):					-0.7		
		Max. EIRP (dBm):					22.42		
		EIRP Limit (dBm):					30.00		
		16QAM	1	0	22.58	22.85	22.75		
			1	37	22.13	22.85	22.41		
			1	74	20.40	22.39	22.46		
			36	0	21.32	21.24	21.41		
			36	16	21.25	21.36	21.51		
			36	35	21.26	21.13	21.23		
			75	0	21.28	21.10	21.28		
		Antenna Gain (dBi):					-0.7		
		Max. EIRP (dBm):					22.15		
		EIRP Limit (dBm):					30.00		
		LTE Band	Bandwidth (MHz)	Modulation	RB Size	RB Offset	Average Power (dBm)		
20050	20175						20300		
1720.0MHz	1732.5MHz						1745.0MHz		
4	20	QPSK	1	0	23.12	23.02	23.12		
			1	49	23.03	23.06	23.10		
			1	99	22.99	22.98	23.03		
			50	0	22.07	22.20	22.47		
			50	24	22.03	22.09	22.15		
			50	49	22.04	22.12	22.20		
			100	0	22.04	22.18	22.03		
		Antenna Gain (dBi):					-0.7		
		Max. EIRP (dBm):					22.42		
		EIRP Limit (dBm):					30.00		
		16QAM	1	0	22.69	22.51	22.39		
			1	49	22.29	22.25	21.90		
			1	99	22.46	21.99	22.20		
			50	0	21.42	21.33	21.42		
			50	24	21.22	21.18	21.35		
			50	49	21.16	21.24	21.19		
			100	0	21.09	21.21	21.24		
		Antenna Gain (dBi):					-0.7		
		Max. EIRP (dBm):					21.99		
		EIRP Limit (dBm):					30.00		
		Note: EIRP (dBm) = Average power (dBm) + Antenna Gain (dBi).							

LTE Band	Bandwidth (MHz)	Modulation	RB Size	RB Offset	Average Power (dBm)				
					20407	20525	20643		
					824.7MHz	836.5MHz	848.3MHz		
5	1.4	QPSK	1	0	23.12	23.12	23.25		
			1	2	23.23	23.07	23.21		
			1	5	23.11	23.16	23.12		
			3	0	22.40	22.45	22.42		
			3	1	22.45	22.38	22.34		
			3	2	22.38	22.32	22.41		
			6	0	22.45	22.25	22.38		
		Antenna Gain(dBi):					-1.5		
		Max. ERP (dBm):					19.60		
		ERP Limit (dBm):					38.45		
		16QAM	1	0	22.35	22.45	22.40		
			1	2	22.10	22.38	22.45		
			1	5	22.04	22.25	22.34		
			3	0	21.56	21.16	21.38		
			3	1	21.54	21.40	21.31		
			3	2	21.43	21.32	21.56		
			6	0	21.12	21.15	21.39		
		Antenna Gain(dBi):					-1.5		
		Max. ERP (dBm):					18.80		
		ERP Limit (dBm):					38.45		
		LTE Band	Bandwidth (MHz)	Modulation	RB Size	RB Offset	Average Power (dBm)		
20415	20525						20635		
825.5MHz	836.5MHz						847.50MHz		
5	3	QPSK	1	0	23.21	23.12	23.25		
			1	7	23.26	23.23	23.21		
			1	14	23.24	23.13	23.11		
			8	0	22.28	22.28	22.30		
			8	4	22.14	22.29	22.32		
			8	7	22.32	22.40	22.24		
			15	0	22.24	22.25	22.27		
		Antenna Gain(dBi):					-1.5		
		Max. ERP (dBm):					19.61		
		ERP Limit (dBm):					38.45		
		16QAM	1	0	22.40	22.26	22.52		
			1	7	22.34	22.23	22.33		
			1	14	22.29	22.30	22.24		
			8	0	21.21	21.31	21.47		
			8	4	21.09	21.06	21.23		
			8	7	21.21	21.21	21.25		
			15	0	21.29	21.04	21.12		
		Antenna Gain(dBi):					-1.5		
		Max. ERP (dBm):					18.87		
		ERP Limit (dBm):					38.45		
		<p>Note: EIRP (dBm) = Average power (dBm) + Antenna Gain (dBi).  ERP (dBm) = EIRP (dBm) - 2.15 (dB).</p>							

LTE Band	Bandwidth (MHz)	Modulation	RB Size	RB Offset	Average Power (dBm)				
					20425	20525	20625		
					826.5MHz	836.5MHz	846.5MHz		
5	5	QPSK	1	0	23.21	23.25	23.23		
			1	12	23.25	23.12	23.21		
			1	24	23.12	23.16	23.20		
			12	0	22.32	22.41	22.32		
			12	6	22.30	22.32	22.20		
			12	11	22.45	22.12	22.31		
			25	0	22.20	22.15	22.24		
		Antenna Gain(dBi):					-1.5		
		Max. ERP (dBm):					19.60		
		ERP Limit (dBm):					38.45		
		16QAM	1	0	22.37	22.20	22.20		
			1	12	22.60	22.53	22.41		
			1	24	22.23	22.25	22.16		
			12	0	21.23	21.24	21.13		
			12	6	21.44	21.58	21.27		
			12	11	21.45	21.13	21.32		
			25	0	21.41	21.07	21.30		
		Antenna Gain(dBi):					-1.5		
		Max. ERP (dBm):					18.95		
		ERP Limit (dBm):					38.45		
		LTE Band	Bandwidth (MHz)	Modulation	RB Size	RB Offset	Average Power (dBm)		
20450	20525						20600		
829.0MHz	836.5MHz						844.0MHz		
5	10	QPSK	1	0	23.12	23.21	23.12		
			1	24	23.11	23.12	23.20		
			1	49	23.24	23.26	23.11		
			25	0	22.26	22.19	22.12		
			25	12	22.16	22.34	22.27		
			25	24	22.23	22.18	22.21		
			50	0	22.18	22.23	22.37		
		Antenna Gain(dBi):					-1.5		
		Max. ERP (dBm):					19.61		
		ERP Limit (dBm):					38.45		
		16QAM	1	0	22.12	22.32	22.27		
			1	24	22.32	22.21	22.52		
			1	49	22.24	22.37	22.80		
			25	0	21.39	21.41	21.51		
			25	12	21.54	21.51	21.45		
			25	24	21.52	21.09	21.54		
			50	0	21.36	21.28	21.13		
		Antenna Gain(dBi):					-1.5		
		Max. ERP (dBm):					19.15		
		ERP Limit (dBm):					38.45		
		<p>Note: EIRP (dBm) = Average power (dBm) + Antenna Gain (dBi).  ERP (dBm) = EIRP (dBm) - 2.15 (dB).</p>							



LTE Band	Bandwidth (MHz)	Modulation	RB Size	RB Offset	Average Power (dBm)				
					20775	21100	21425		
					2502.5MHz	2535.0MHz	2567.5MHz		
7	5	QPSK	1	0	23.12	23.25	22.83		
			1	12	23.25	23.12	22.62		
			1	24	22.99	23.23	22.78		
			12	0	22.45	22.50	22.72		
			12	6	22.43	22.59	22.54		
			12	11	22.53	22.56	22.16		
			25	0	22.38	22.47	22.37		
		Antenna Gain (dBi):					0.27		
		Max. EIRP (dBm):					23.52		
		EIRP Limit (dBm):					33.00		
		16QAM	1	0	22.50	22.41	22.50		
			1	12	22.41	22.91	22.51		
			1	24	22.54	22.38	21.89		
			12	0	21.39	21.87	21.86		
			12	6	21.50	21.54	21.90		
			12	11	21.71	21.82	21.95		
			25	0	21.55	21.73	21.87		
		Antenna Gain (dBi):					0.27		
		Max. EIRP (dBm):					23.18		
		EIRP Limit (dBm):					33.00		
		LTE Band	Bandwidth (MHz)	Modulation	RB Size	RB Offset	Average Power (dBm)		
20800	21100						21400		
2505.0MHz	2535.0MHz						2565.0MHz		
7	10	QPSK	1	0	23.12	23.42	22.98		
			1	24	23.23	23.23	22.89		
			1	49	23.11	23.41	22.86		
			25	0	22.38	22.54	22.56		
			25	12	22.34	22.51	22.60		
			25	24	22.43	22.46	22.35		
			50	0	22.47	22.50	22.54		
		Antenna Gain (dBi):					0.27		
		Max. EIRP (dBm):					23.69		
		EIRP Limit (dBm):					33.00		
		16QAM	1	0	22.62	22.65	22.45		
			1	24	22.45	22.63	22.48		
			1	49	22.67	22.49	21.60		
			25	0	21.69	21.77	21.85		
			25	12	21.73	21.93	21.77		
			25	24	21.55	21.86	21.80		
			50	0	21.67	21.82	21.91		
		Antenna Gain (dBi):					0.27		
		Max. EIRP (dBm):					22.94		
		EIRP Limit (dBm):					33.00		
		<i>Note: EIRP (dBm) = Average power (dBm) + Antenna Gain (dBi).</i>							

LTE Band	Bandwidth (MHz)	Modulation	RB Size	RB Offset	Average Power (dBm)				
					20825	21100	21375		
					2507.5MHz	2535.0MHz	2562.5MHz		
7	15	QPSK	1	0	22.53	23.12	23.11		
			1	37	22.41	23.22	23.02		
			1	74	22.67	22.89	22.14		
			36	0	22.52	22.57	22.75		
			36	16	22.46	22.63	22.52		
			36	35	22.54	22.58	22.17		
			75	0	22.41	22.51	22.44		
		Antenna Gain (dBi):					0.27		
		Max. EIRP (dBm):					23.49		
		EIRP Limit (dBm):					33.00		
		16QAM	1	0	22.26	22.74	22.54		
			1	37	22.51	22.56	22.50		
			1	74	22.74	22.34	21.60		
			36	0	21.68	21.75	21.91		
			36	16	21.62	21.83	21.99		
			36	35	21.64	21.90	21.70		
			75	0	21.66	21.70	21.79		
		Antenna Gain (dBi):					0.27		
		Max. EIRP (dBm):					23.01		
		EIRP Limit (dBm):					33.00		
		LTE Band	Bandwidth (MHz)	Modulation	RB Size	RB Offset	Average Power (dBm)		
20850	21100						21350		
2510.0MHz	2535.0MHz						2560.0MHz		
7	20	QPSK	1	0	22.65	23.22	22.75		
			1	49	22.74	23.16	22.83		
			1	99	22.56	23.19	22.64		
			50	0	22.21	22.71	22.40		
			50	24	22.35	22.59	22.51		
			50	49	22.45	22.62	22.41		
			100	0	22.50	22.57	22.35		
		Antenna Gain (dBi):					0.27		
		Max. EIRP (dBm):					23.49		
		EIRP Limit (dBm):					33.00		
		16QAM	1	0	22.38	22.53	22.33		
			1	49	22.11	22.25	22.25		
			1	99	22.81	22.69	22.21		
			50	0	21.39	21.68	21.91		
			50	24	21.79	21.81	21.95		
			50	49	21.67	21.67	21.80		
			100	0	21.70	21.72	21.85		
		Antenna Gain (dBi):					0.27		
		Max. EIRP (dBm):					23.08		
		EIRP Limit (dBm):					33.00		

Note: EIRP (dBm) = Average power (dBm) + Antenna Gain (dBi).

## 6.2 Peak-to-Average Ratio

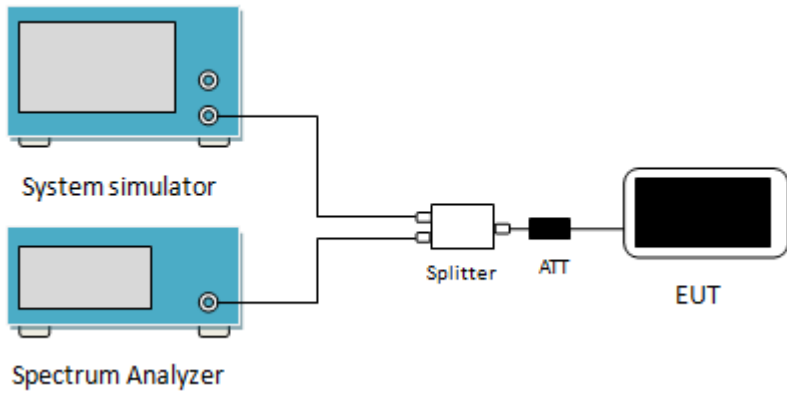
Test Requirement:	Part 24.232 (d), Part 27.50(d)(5)
Limit:	The peak-to-average ratio (PAR) of the transmission may not exceed 13 dB.
Test Setup:	 <p>The diagram illustrates the test setup. On the left, there are two blue rectangular units: the top one is labeled 'System simulator' and the bottom one is labeled 'Spectrum Analyzer'. Both have a screen and two circular ports on their right side. A single line connects the top port of the System simulator to the top port of the Spectrum Analyzer. From the bottom port of the System simulator, a line goes to the left input of a white rectangular 'Splitter'. From the right output of the Splitter, a line goes to a black rectangular 'ATT' (Attenuator). From the right output of the ATT, a line goes to the left side of a black rectangular 'EUT' (Equipment Under Test).</p>
Test Procedure:	<ol style="list-style-type: none"> <li>1 The RF output of the transceiver was connected to a spectrum analyzer through appropriate attenuation.</li> <li>2 Set the CCDF option in spectrum analyzer, <math>RBW \geq OBW</math>,</li> <li>3 Set the EUT working in highest power level, measured and recorded the 0.1% as PAPR level.</li> <li>4 Repeat step 1~3 at other frequency and modulations.</li> </ol>
Test Instruments:	Refer to section 5.10 for details
Test mode:	Refer to section 5.3 for details
Test results:	Passed

**Measurement Data (Worst case):**

Bandwidth	Modulation	RB Size	RB Offset	PAPR
LTE Band 4 (Middle Channel)				
20MHz	QPSK	100	0	4.58
	16QAM	100	0	5.36
LTE Band 5 (Middle Channel)				
10MHz	QPSK	50	0	4.70
	16QAM	50	0	5.77
LTE Band 7 (Middle Channel)				
20MHz	QPSK	100	0	4.17
	16QAM	100	0	5.07

Test plots as below:

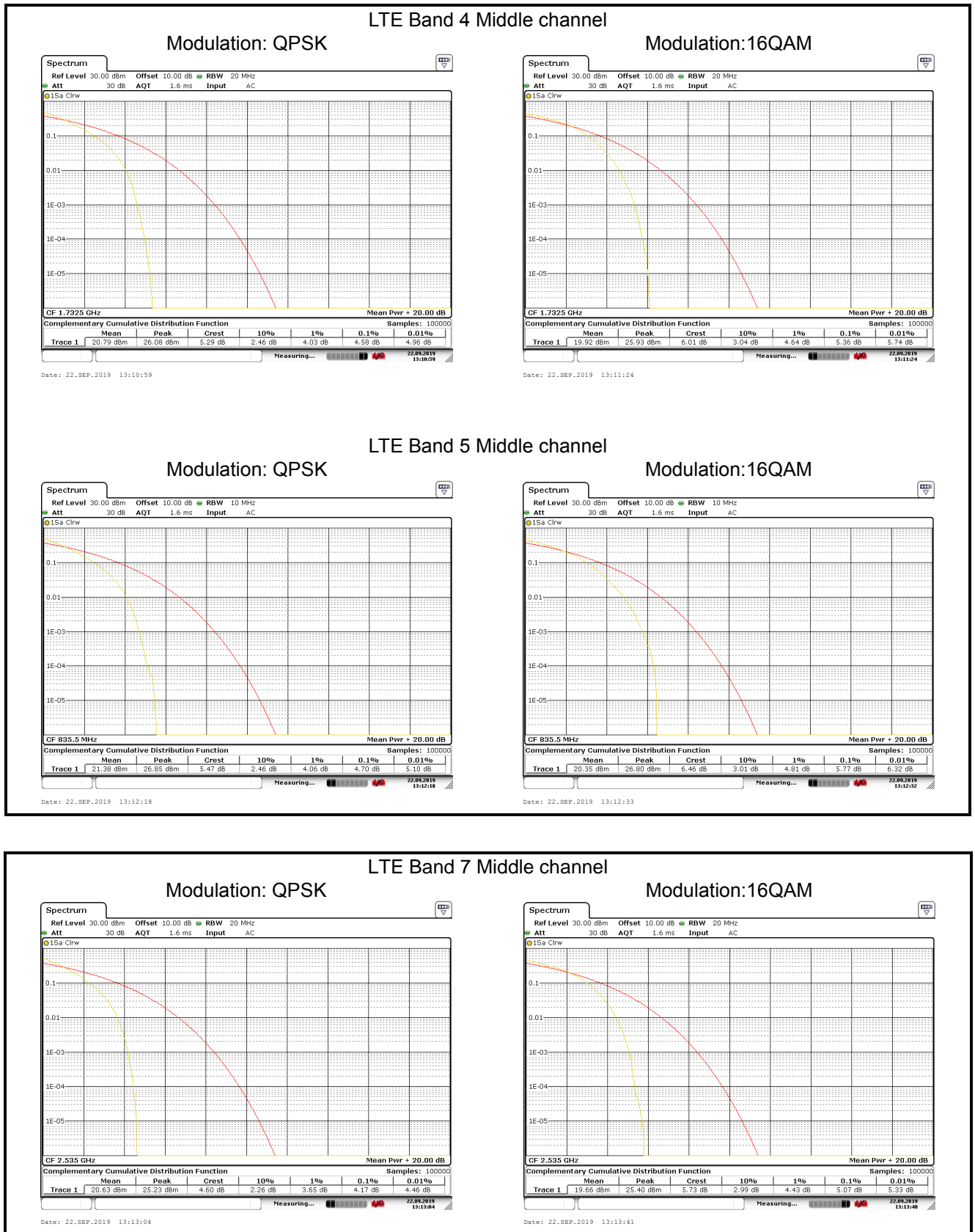

## 6.3 Occupy Bandwidth

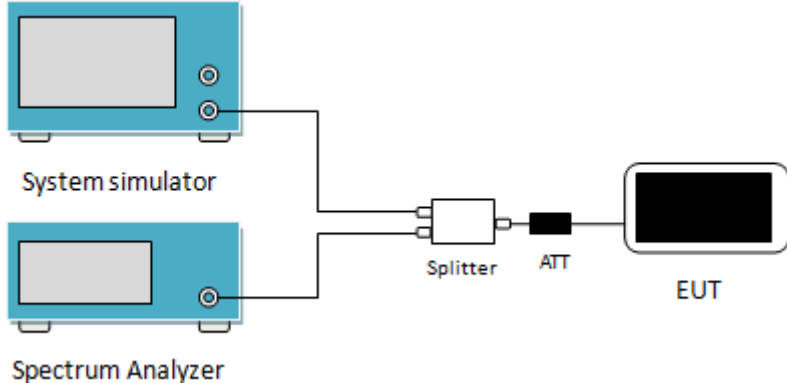
Test Requirement:	Part 22.917(b) , Part 27.53(h), Part 27.53(m)
Test Setup:	 <p>The diagram shows a test setup. On the left, there are two blue rectangular units: the top one is labeled 'System simulator' and the bottom one is labeled 'Spectrum Analyzer'. Both have two circular ports on their right side. A single line from the top port of the System simulator and a single line from the top port of the Spectrum Analyzer merge into a single line that enters a white rectangular 'Splitter' box. From the right side of the Splitter, a line goes to a black rectangular 'ATT' (Attenuator) box. From the right side of the ATT, a line goes to a black rectangular 'EUT' (Equipment Under Test) box.</p>
Test Procedure:	<ol style="list-style-type: none"> <li>1. The EUT's output RF connector was connected with a short cable to the spectrum analyzer</li> <li>2. RBW was set to about 1% ~ 5% of emission BW, VBW= 3 times RBW.</li> <li>3. -26dBc display line was placed on the screen (or 99% bandwidth), the occupied bandwidth is the delta frequency between the two points where the display line intersects the signal trace.</li> </ol>
Test Instruments:	Refer to section 5.10 for details
Test mode:	Refer to section 5.3 for details
Test results:	Passed

**Measurement Data:**

LTE Band 4					
Bandwidth	Channel	Frequency (MHz)	Modulation	99% OBW (kHz)	-26dBcEBW (kHz)
1.4MHz	19957	1710.7	16QAM	1098	1254
			QPSK	1098	1272
	20175	1732.5	16QAM	1098	1248
			QPSK	1104	1272
	20393	1754.3	16QAM	1098	1248
			QPSK	1098	1266
3MHz	19965	1711.5	16QAM	2748	3036
			QPSK	2760	3120
	20175	1732.5	16QAM	2736	3108
			QPSK	2760	3168
	20385	1750.5	16QAM	2736	3048
			QPSK	2772	3132
5MHz	19975	1712.5	16QAM	4500	4900
			QPSK	4520	4960
	20175	1732.5	16QAM	4520	4880
			QPSK	4520	5000
	20375	1752.5	16QAM	4480	5020
			QPSK	4540	4940
10MHz	20000	1715.0	16QAM	9120	10080
			QPSK	9160	10640
	20175	1732.5	16QAM	9120	10160
			QPSK	9080	10280
	20350	1750.0	16QAM	9160	10080
			QPSK	9160	10160
15MHz	20025	1717.5	16QAM	13500	14940
			QPSK	13620	15120
	20175	1732.5	16QAM	13500	14760
			QPSK	13500	14940
	20325	1747.5	16QAM	13560	14760
			QPSK	13560	15120
20MHz	20050	1720.0	16QAM	18000	19440
			QPSK	18160	19840
	20175	1732.5	16QAM	18000	19600
			QPSK	18000	19600
	20300	1745.0	16QAM	18080	19520
			QPSK	18080	19760

TE Band 5					
Bandwidth	Channel	Frequency (MHz)	Modulation	99% OBW (kHz)	-26dBcEBW (kHz)
1.4MHz	20407	824.7	16QAM	1098	1254
			QPSK	1104	1278
	20525	836.5	16QAM	1098	1254
			QPSK	1098	1242
	20643	848.3	16QAM	1098	1260
			QPSK	1098	1254
3MHz	20415	825.5	16QAM	2748	3060
			QPSK	2760	3120
	20525	836.50	16QAM	2748	3000
			QPSK	2760	3144
	20635	847.50	16QAM	2760	3096
			QPSK	2748	3144
5MHz	20425	826.50	16QAM	4500	4900
			QPSK	4520	4980
	20525	836.50	16QAM	4500	4900
			QPSK	4500	4900
	20625	846.50	16QAM	4500	4920
			QPSK	4520	4960
10MHz	20450	829.00	16QAM	9080	10080
			QPSK	9120	10280
	20525	836.50	16QAM	9120	10080
			QPSK	9120	10320
	20600	844.00	16QAM	9120	10080
			QPSK	9120	10320



LTE Band 7					
Bandwidth	Channel	Frequency (MHz)	Modulation	99% OBW (kHz)	-26dBcEBW (kHz)
5MHz	20775	2502.5	16QAM	4500	4940
			QPSK	4500	5040
	21100	2535.0	16QAM	4520	4840
			QPSK	4520	4980
	21425	2567.5	16QAM	4520	4900
			QPSK	4520	5040
10MHz	20800	2505.0	16QAM	9080	10120
			QPSK	9160	10440
	21100	2535.0	16QAM	9160	10040
			QPSK	9120	10400
	21400	2565.0	16QAM	9160	10080
			QPSK	9200	10360
15MHz	20825	2507.5	16QAM	13620	14880
			QPSK	13620	15060
	21100	2535.0	16QAM	13560	14880
			QPSK	13560	14820
	21375	2562.5	16QAM	13560	14940
			QPSK	13560	15060
20MHz	20850	2510.0	16QAM	18080	19360
			QPSK	18000	19840
	21100	2535.0	16QAM	17920	19280
			QPSK	18080	20080
	21350	2560.0	16QAM	18000	19680
			QPSK	18080	20160

Test plot as follows:  
LTE Band 4 part:

LTE Band 4: 99% Occupy bandwidth  
BW: 1.4MHz

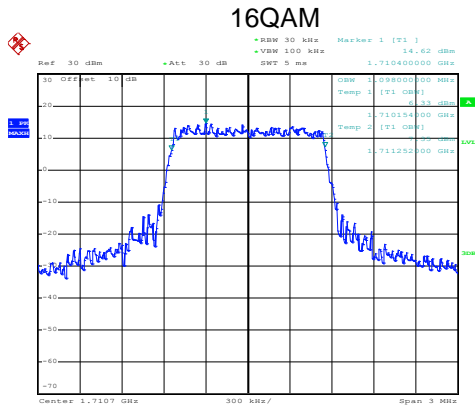

Date: 20.SEP.2019 09:09:12

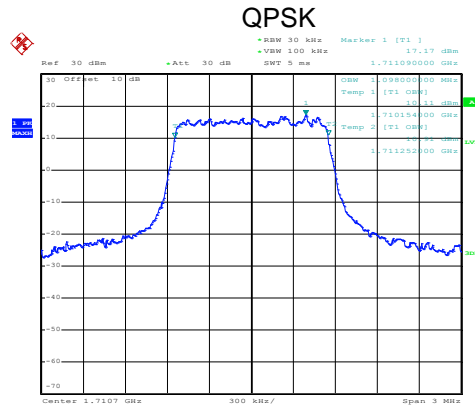

Date: 20.SEP.2019 09:09:06

Lowest channel

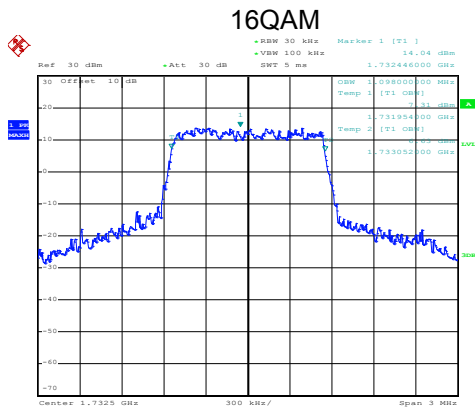

Date: 20.SEP.2019 09:10:14

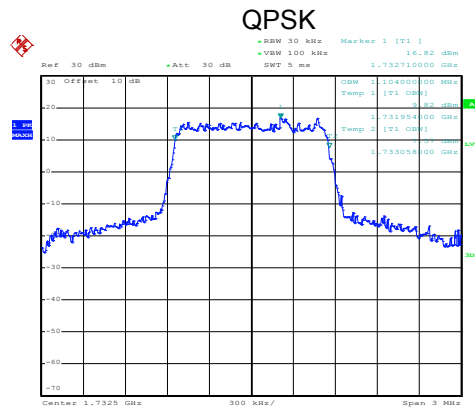

Date: 20.SEP.2019 09:10:10

Middle channel

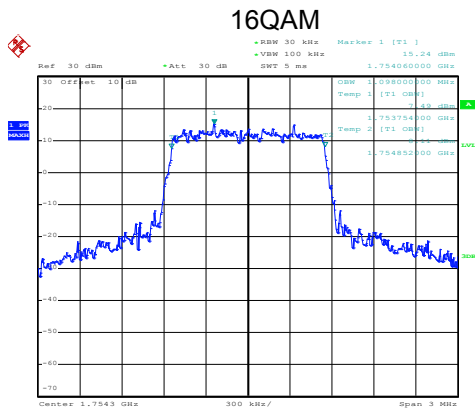

Date: 20.SEP.2019 09:10:31

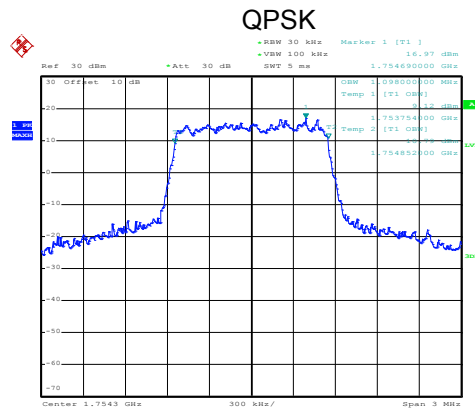

Date: 20.SEP.2019 09:10:28

Highest channel

LTE Band 4: 99% Occupy bandwidth  
BW: 3MHz

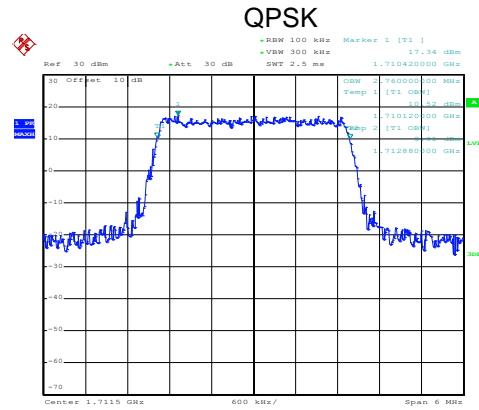
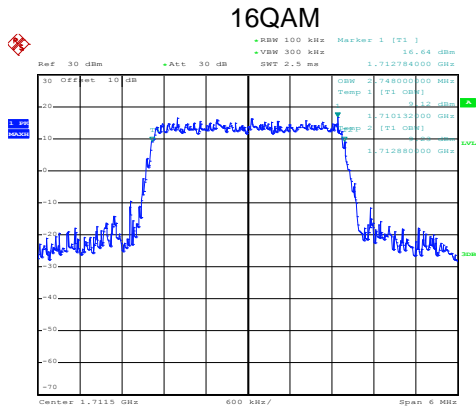

Date: 20.SEP.2019 09:11:33

Date: 20.SEP.2019 09:11:30

Lowest channel

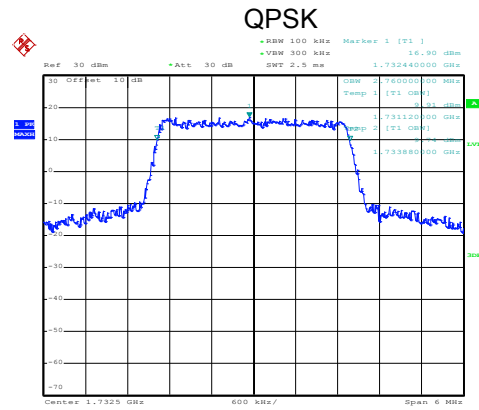
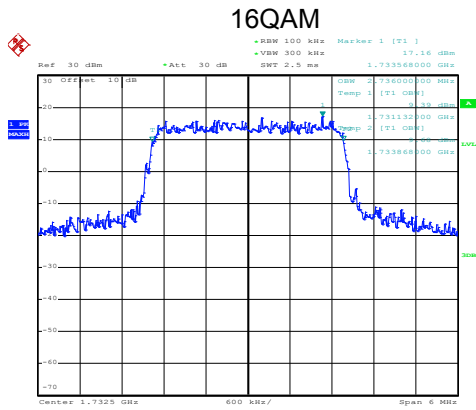

Date: 20.SEP.2019 09:11:50

Date: 20.SEP.2019 09:11:47

Middle channel

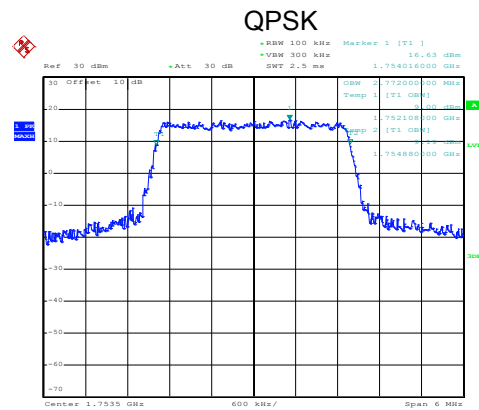
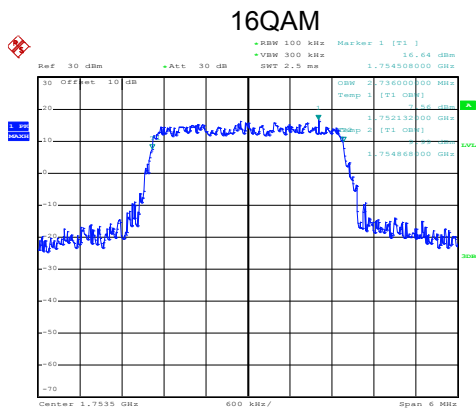

Date: 20.SEP.2019 09:12:36

Date: 20.SEP.2019 09:12:30

Highest channel

LTE Band 4: 99% Occupancy bandwidth  
BW: 5MHz

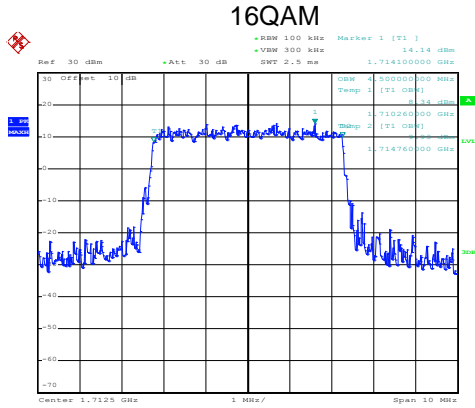

Date: 20.SEP.2019 09:13:40

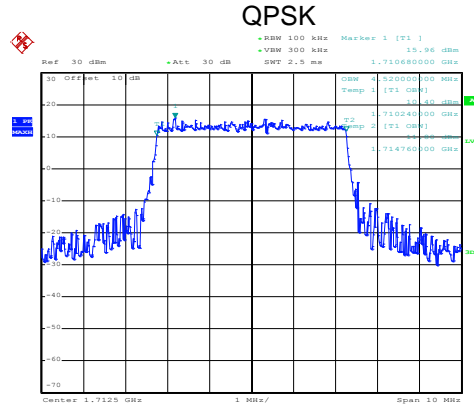

Date: 20.SEP.2019 09:13:36

Lowest channel

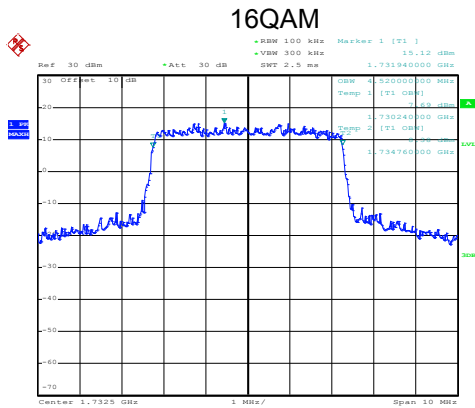

Date: 20.SEP.2019 09:14:21

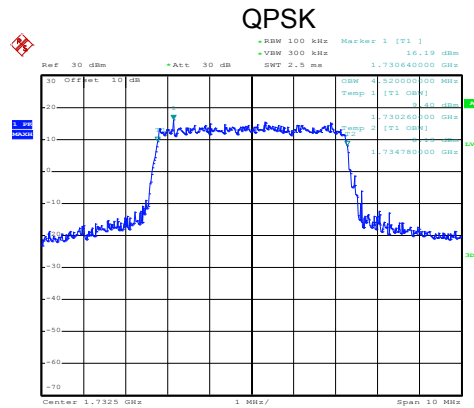

Date: 20.SEP.2019 09:14:13

Middle channel

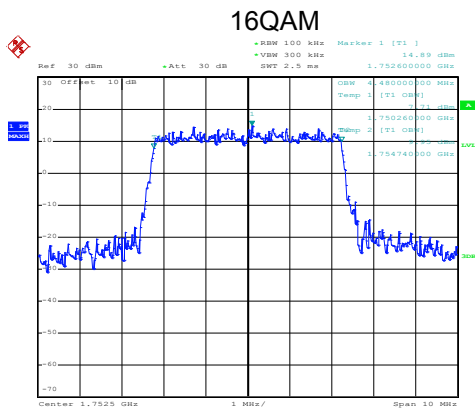

Date: 20.SEP.2019 09:14:37

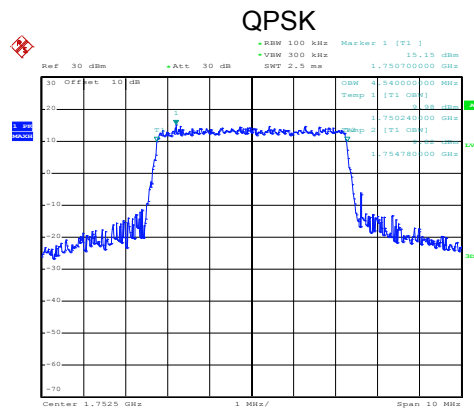

Date: 20.SEP.2019 09:14:33

Highest channel

LTE Band 4: 99% Occupy bandwidth  
BW: 10MHz

16QAM

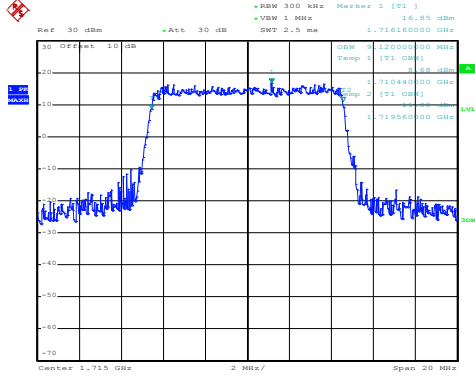

Date: 20.SEP.2019 09:16:25

QPSK

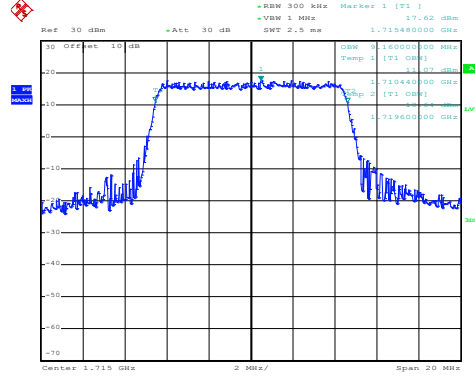

Date: 20.SEP.2019 09:16:22

Lowest channel

16QAM

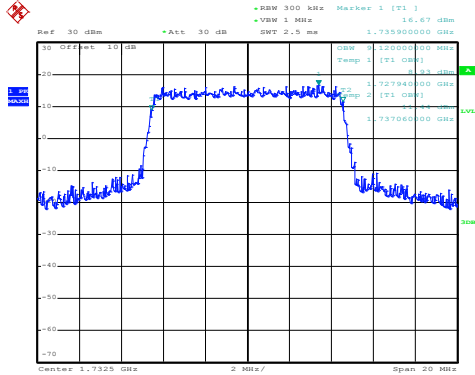

Date: 20.SEP.2019 09:16:47

QPSK

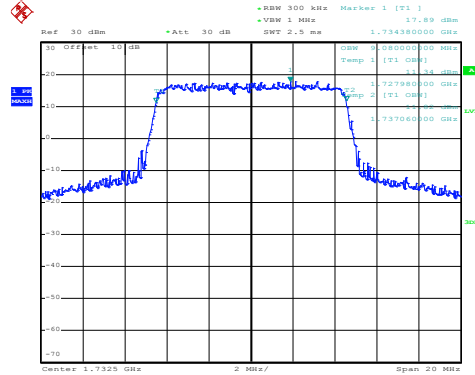

Date: 20.SEP.2019 09:16:43

Middle channel

16QAM

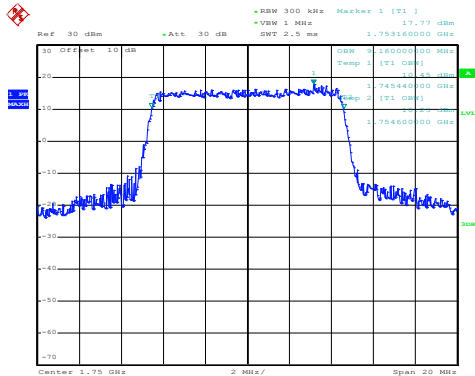

Date: 20.SEP.2019 09:17:29

QPSK

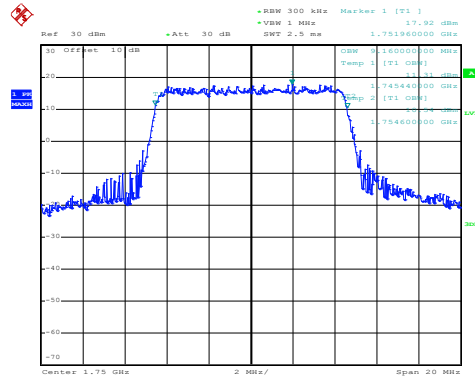

Date: 20.SEP.2019 09:17:22

Highest channel

LTE Band 4: 99% Occupancy bandwidth  
BW: 15MHz

16QAM

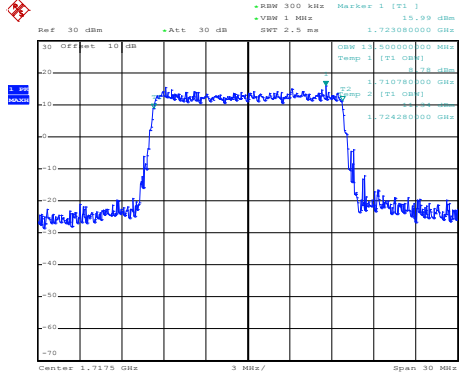

Date: 20.SEP.2019 09:17:58

QPSK

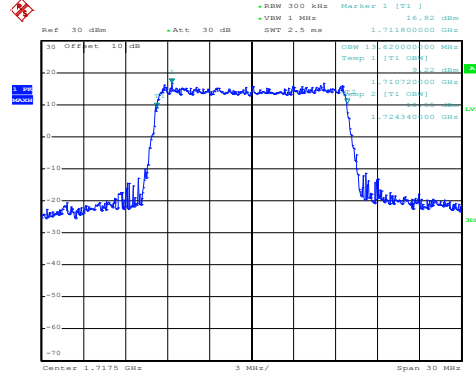

Date: 20.SEP.2019 09:17:54

Lowest channel

16QAM

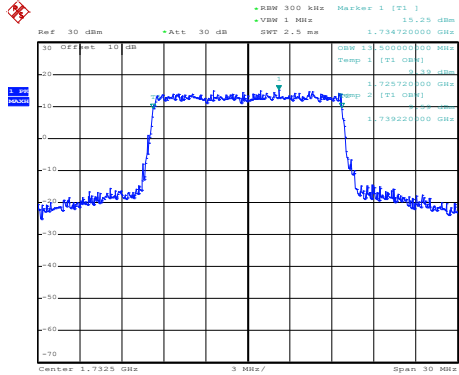

Date: 20.SEP.2019 09:18:51

QPSK

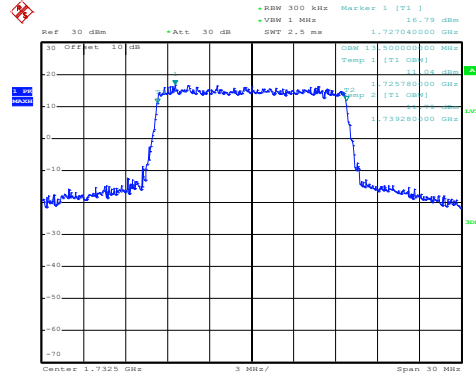

Date: 20.SEP.2019 09:18:47

Middle channel

16QAM

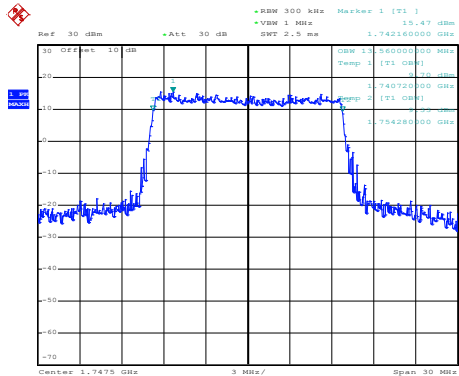

Date: 20.SEP.2019 09:19:12

QPSK

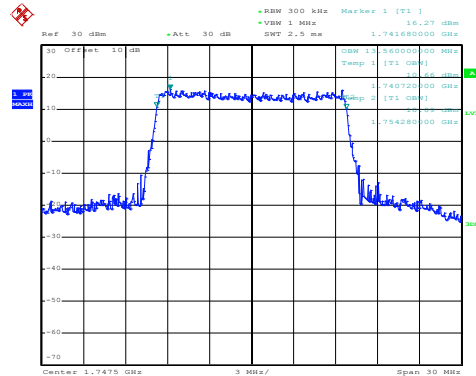

Date: 20.SEP.2019 09:19:08

Highest channel

LTE Band 4: 99% Occupancy bandwidth  
BW: 20MHz

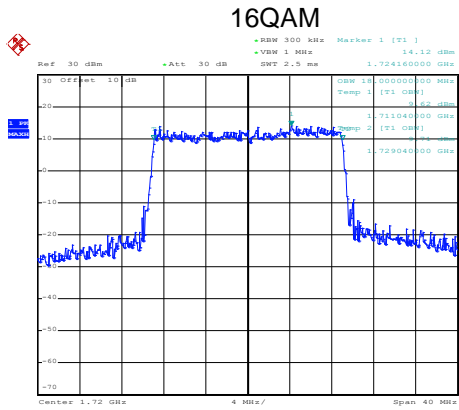

Date: 20.SEP.2019 09:20:46

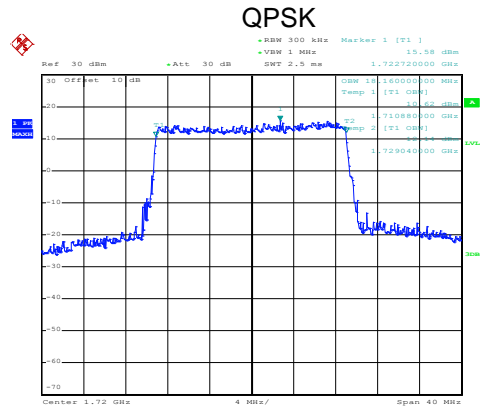

Date: 20.SEP.2019 09:20:43

Lowest channel

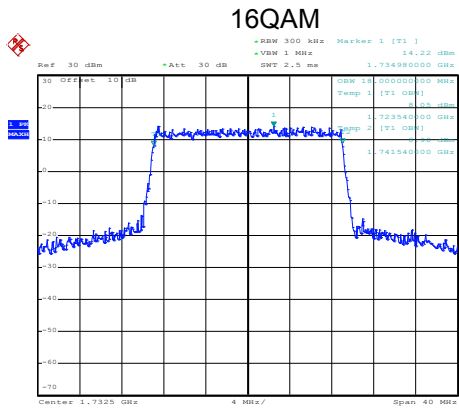

Date: 20.SEP.2019 09:21:03

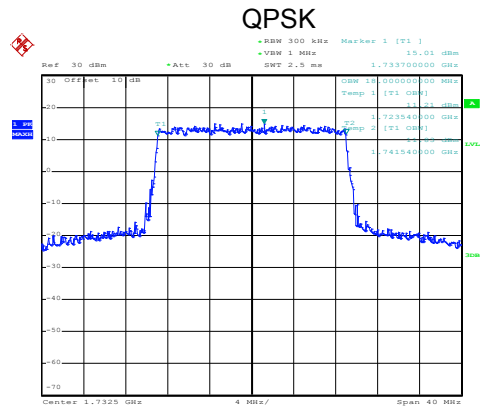

Date: 20.SEP.2019 09:20:57

Middle channel

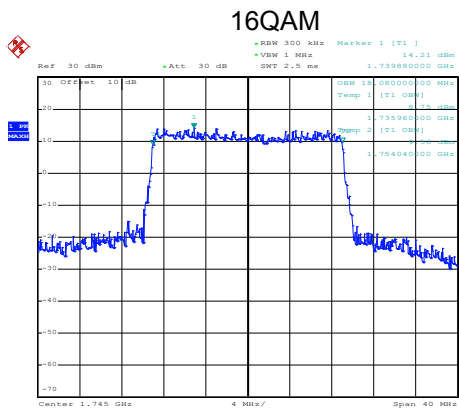

Date: 20.SEP.2019 09:21:42

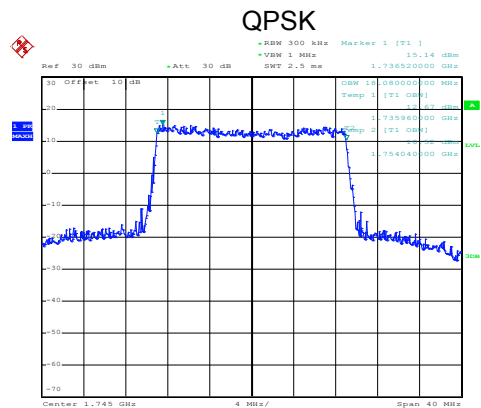

Date: 20.SEP.2019 09:21:38

Highest channel

LTE Band 4: -26dBc bandwidth  
BW: 1.4MHz

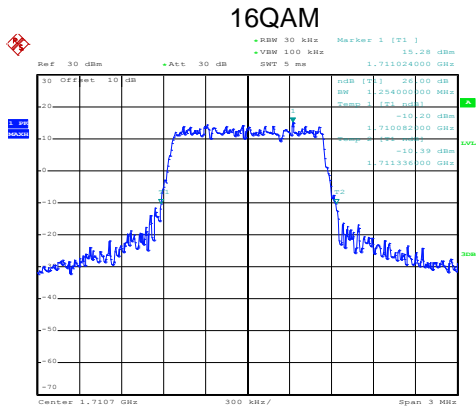

Date: 20.SEP.2019 09:09:26

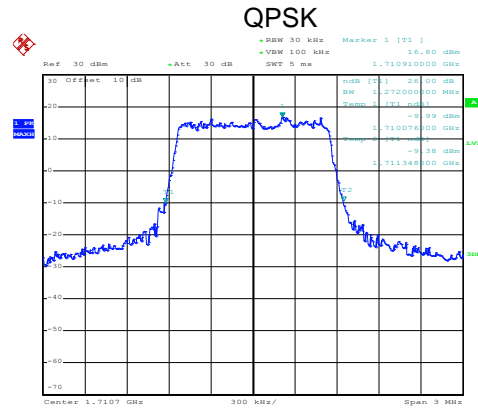

Date: 20.SEP.2019 09:09:23

Lowest channel

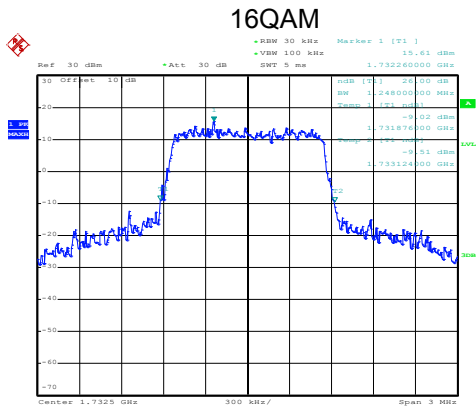

Date: 20.SEP.2019 09:10:01

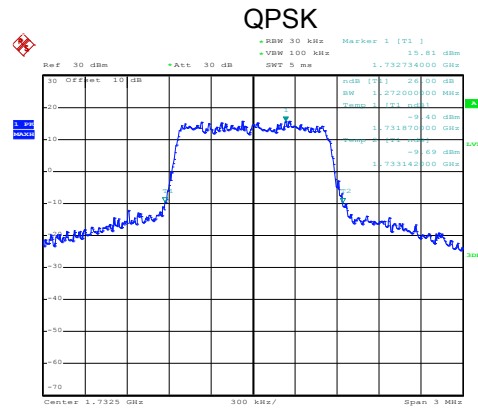

Date: 20.SEP.2019 09:09:57

Middle channel

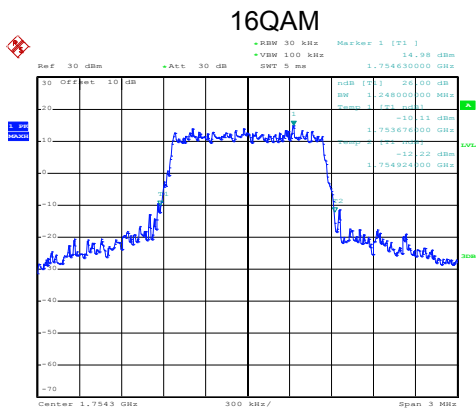

Date: 20.SEP.2019 09:10:43

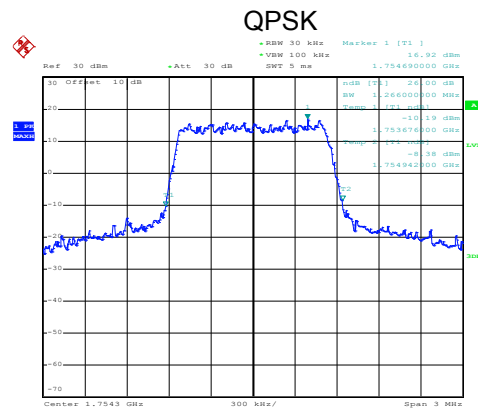

Date: 20.SEP.2019 09:10:40

Highest channel



LTE Band 4: -26dBc bandwidth  
BW: 3MHz

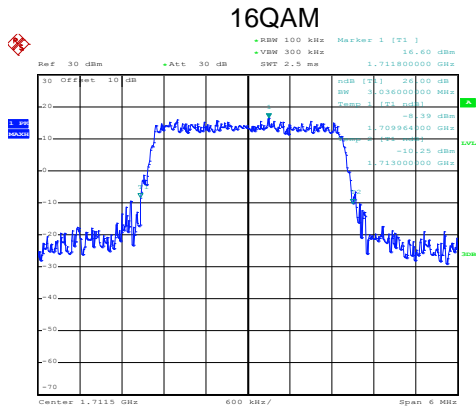

Date: 20.SEP.2019 09:11:21

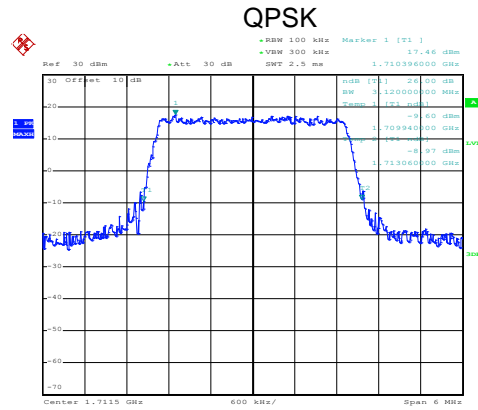

Date: 20.SEP.2019 09:11:17

Lowest channel

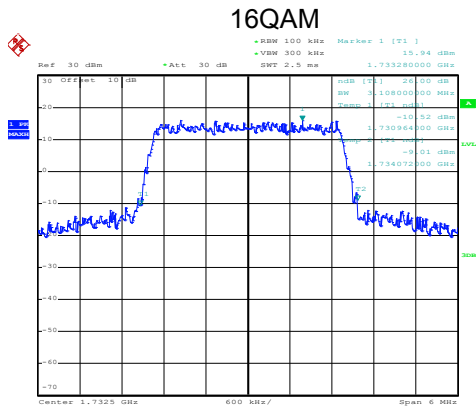

Date: 20.SEP.2019 09:12:01

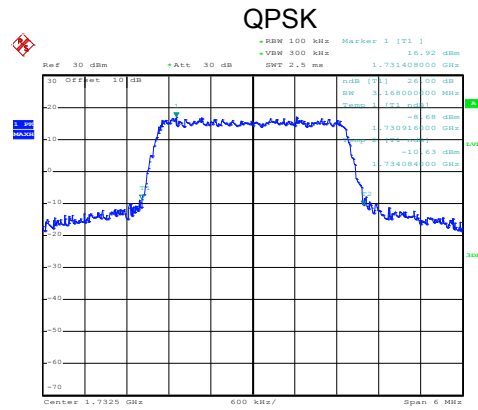

Date: 20.SEP.2019 09:11:58

Middle channel

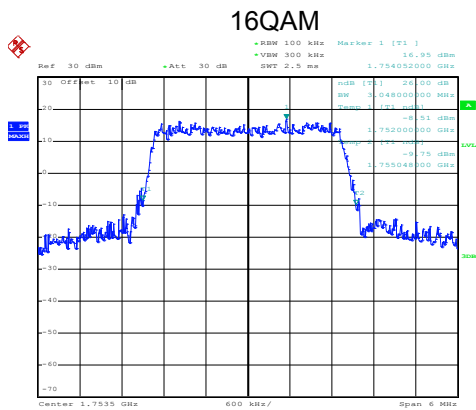

Date: 20.SEP.2019 09:12:21

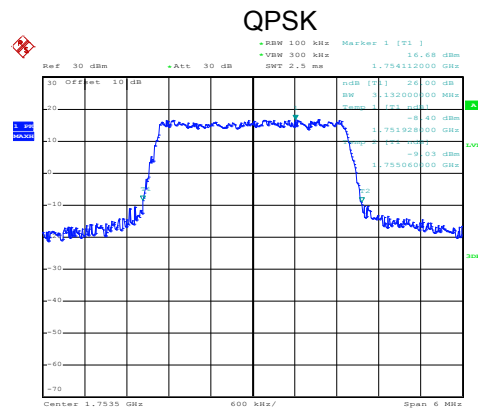

Date: 20.SEP.2019 09:12:18

Highest channel

LTE Band 4: -26dBc bandwidth  
BW: 5MHz

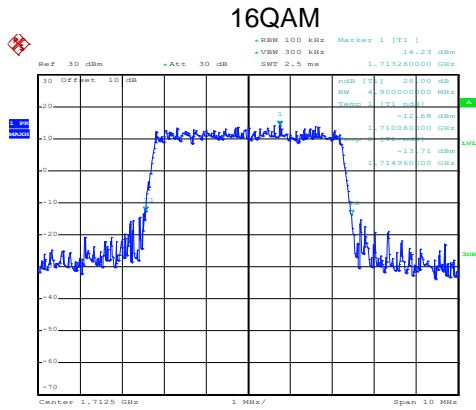

Date: 20.SEP.2019 09:13:51

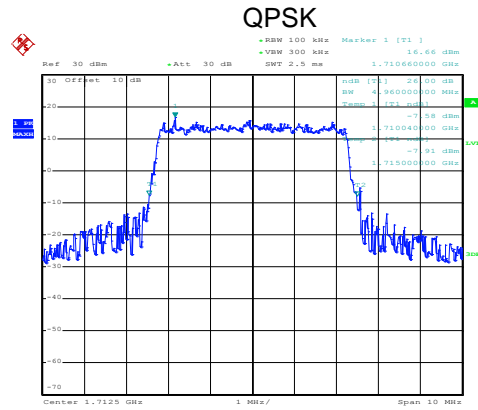

Date: 20.SEP.2019 09:13:48

Lowest channel

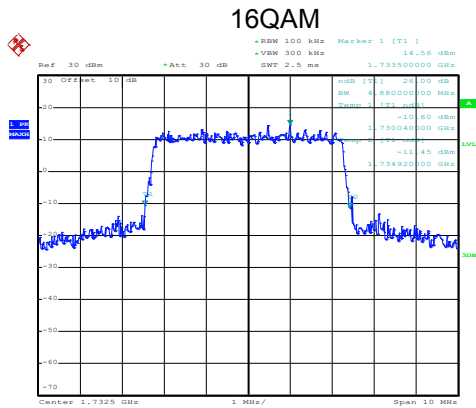

Date: 20.SEP.2019 09:14:05

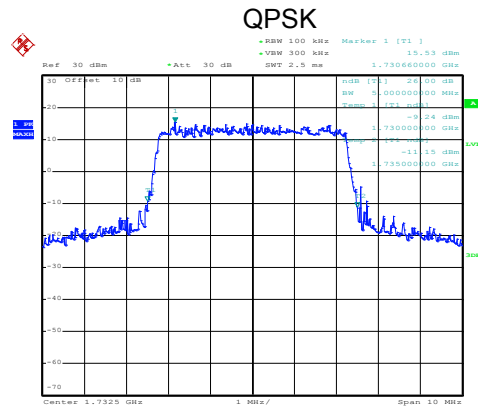

Date: 20.SEP.2019 09:14:02

Middle channel

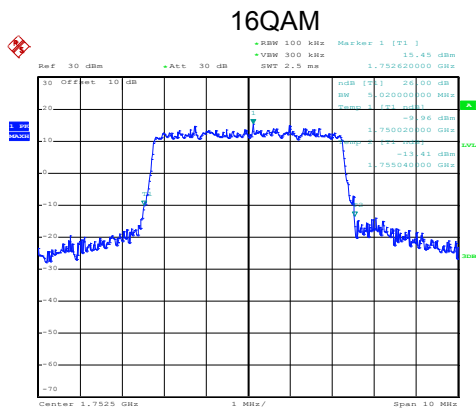

Date: 20.SEP.2019 09:14:56

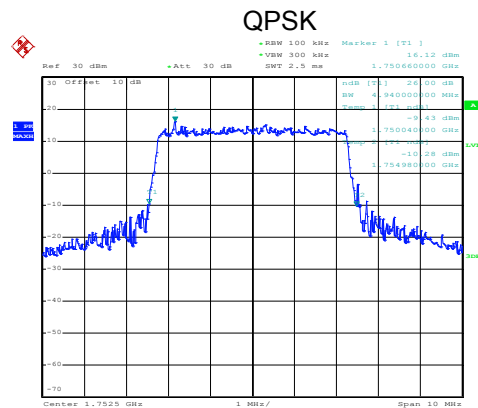

Date: 20.SEP.2019 09:14:46

Highest channel

LTE Band 4: -26dBc bandwidth  
BW: 10MHz

16QAM

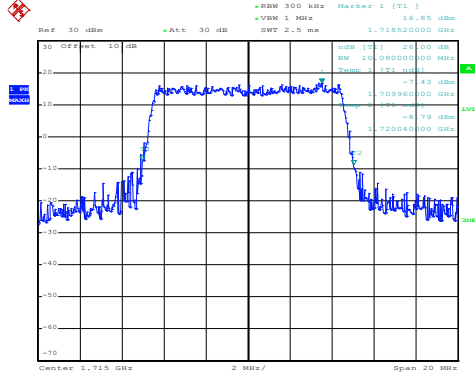

Date: 20.SEP.2019 09:16:14

QPSK

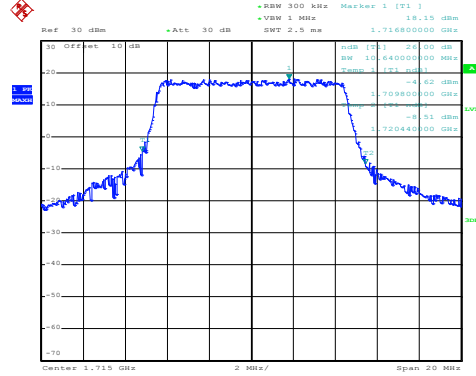

Date: 20.SEP.2019 09:16:10

Lowest channel

16QAM

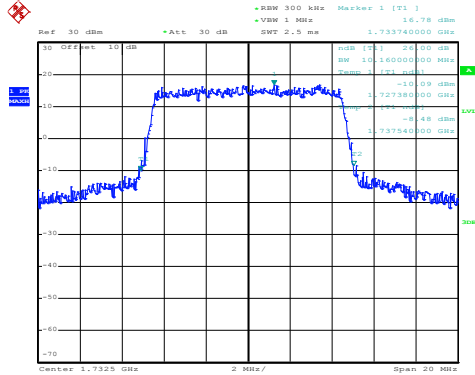

Date: 20.SEP.2019 09:16:58

QPSK

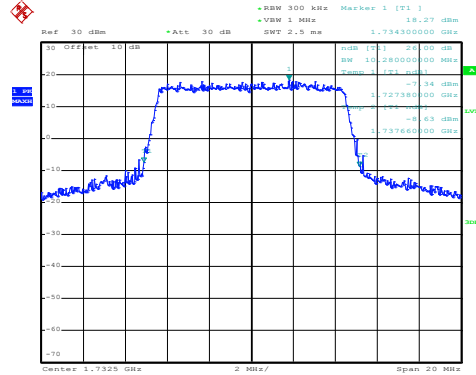

Date: 20.SEP.2019 09:16:55

Middle channel

16QAM

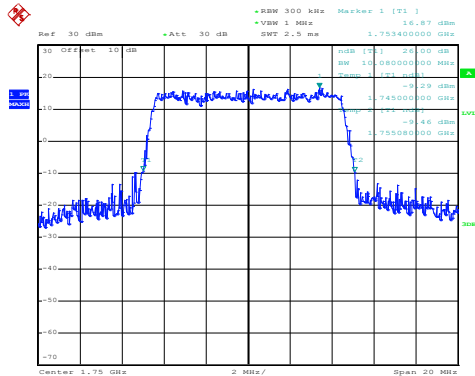

Date: 20.SEP.2019 09:17:15

QPSK

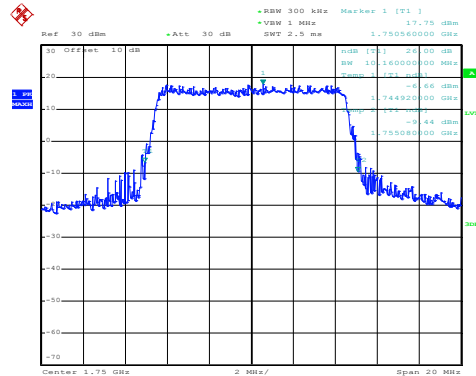

Date: 20.SEP.2019 09:17:11

Highest channel

LTE Band 4: -26dBc bandwidth  
BW: 15MHz

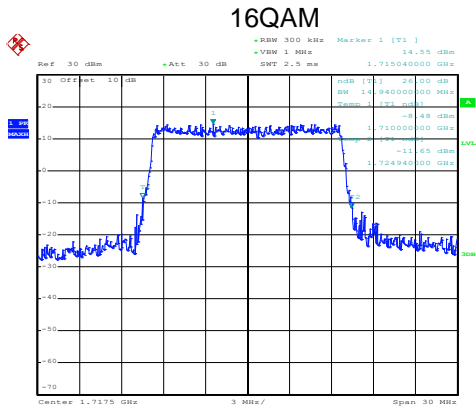

Date: 20.SEP.2019 09:18:09

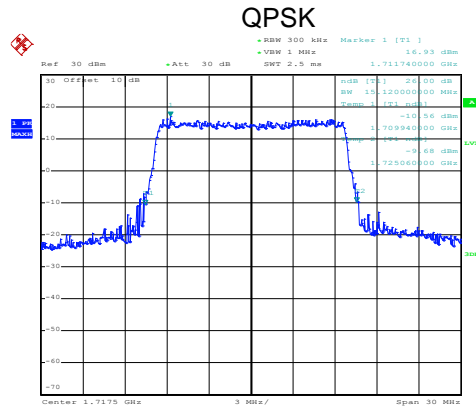

Date: 20.SEP.2019 09:18:06

Lowest channel

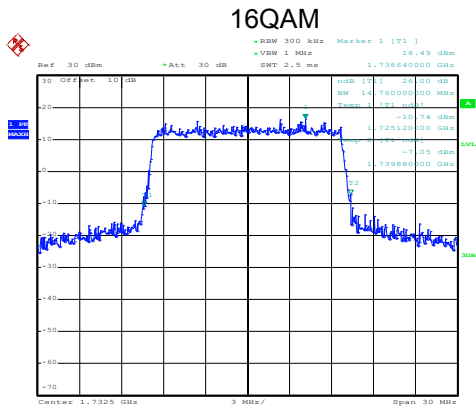

Date: 20.SEP.2019 09:18:36

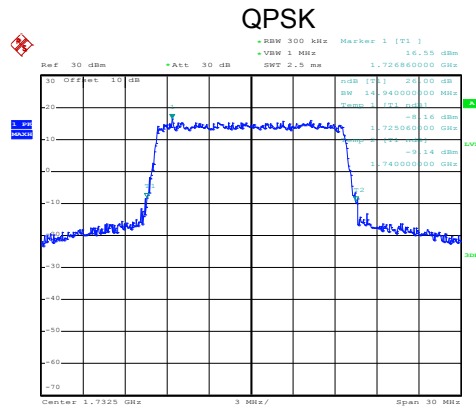

Date: 20.SEP.2019 09:18:33

Middle channel

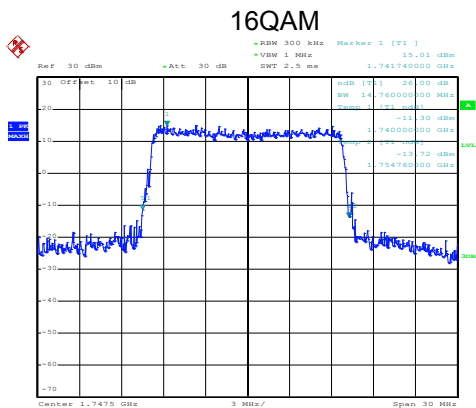

Date: 20.SEP.2019 09:19:25

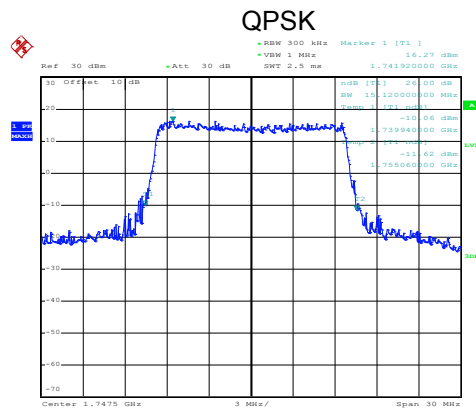

Date: 20.SEP.2019 09:19:21

Highest channel

LTE Band 4: -26dBc bandwidth  
BW: 20MHz

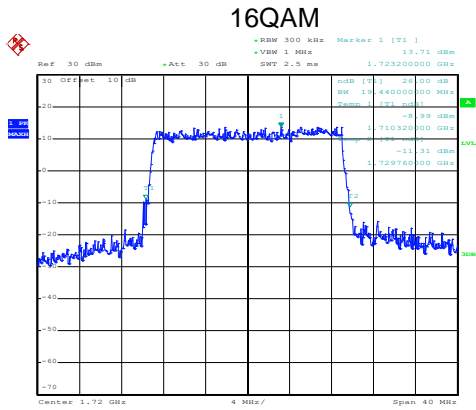

Date: 20.SEP.2019 09:20:33

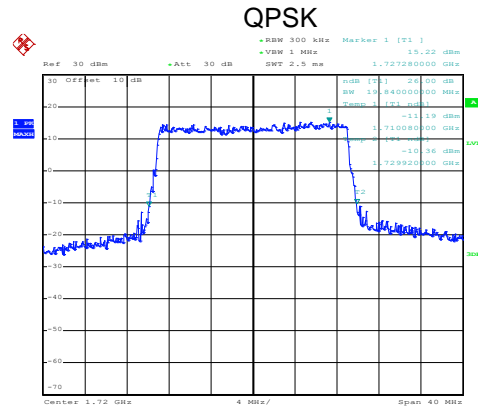

Date: 20.SEP.2019 09:20:28

Lowest channel

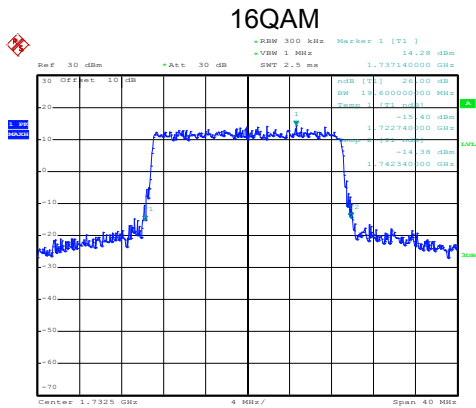

Date: 20.SEP.2019 09:21:14

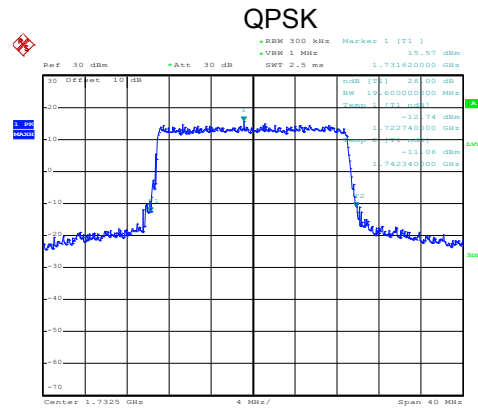

Date: 20.SEP.2019 09:21:11

Middle channel

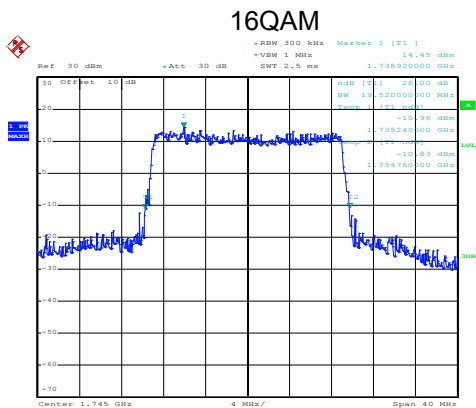

Date: 20.SEP.2019 09:21:30

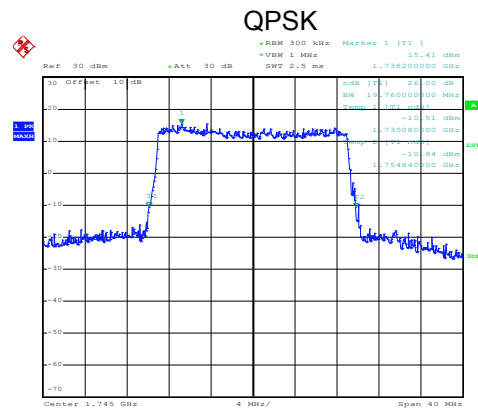

Date: 20.SEP.2019 09:21:26

Highest channel

LTE Band 5 part:

LTE Band 5: 99% Occupy bandwidth  
BW: 1.4MHz

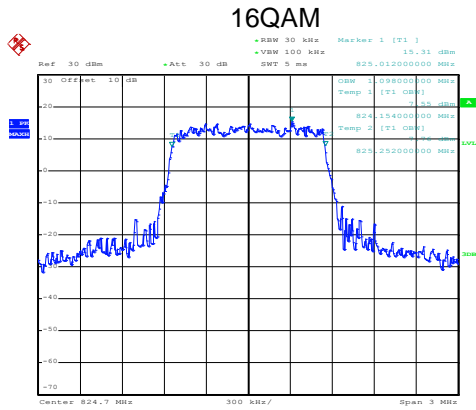

Date: 20.SEP.2019 09:22:31

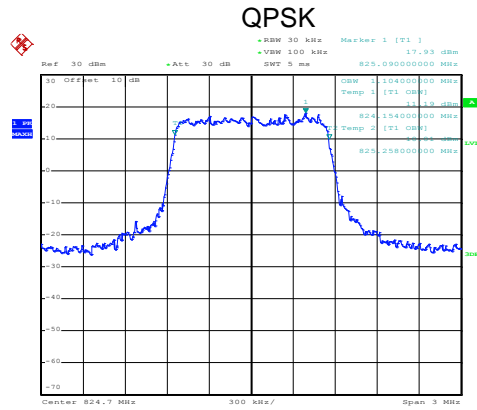

Date: 20.SEP.2019 09:22:27

Lowest channel

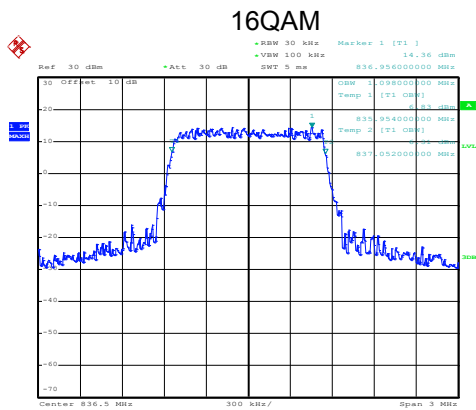

Date: 20.SEP.2019 09:23:10

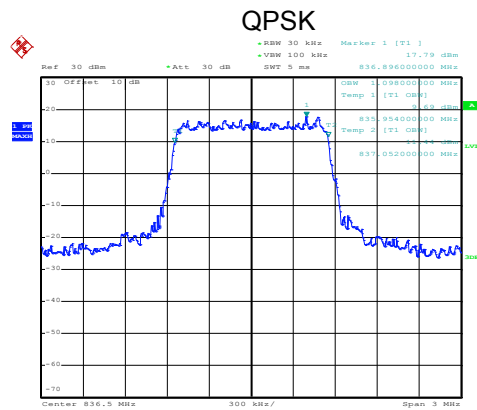

Date: 20.SEP.2019 09:23:07

Middle channel

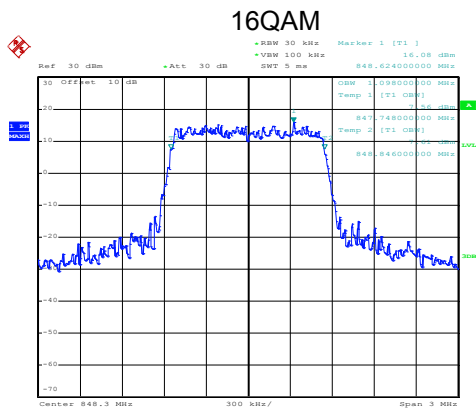

Date: 20.SEP.2019 09:23:25

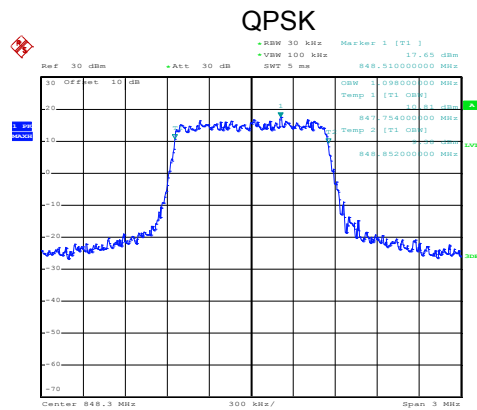

Date: 20.SEP.2019 09:23:22

Highest channel

LTE Band 5: 99% Occupy bandwidth  
BW: 3MHz

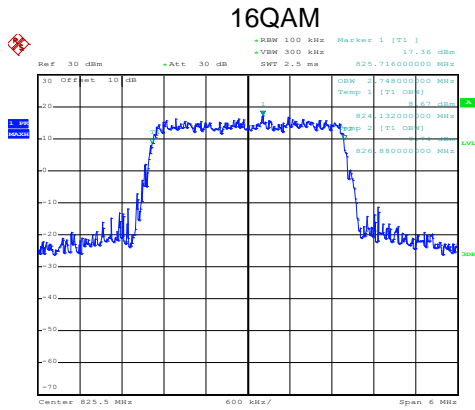

Date: 20.SEP.2019 09:24:31

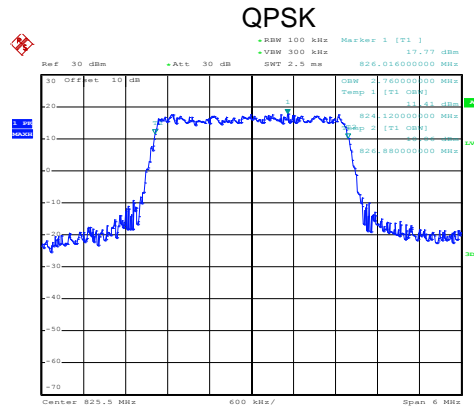

Date: 20.SEP.2019 09:24:28

Lowest channel

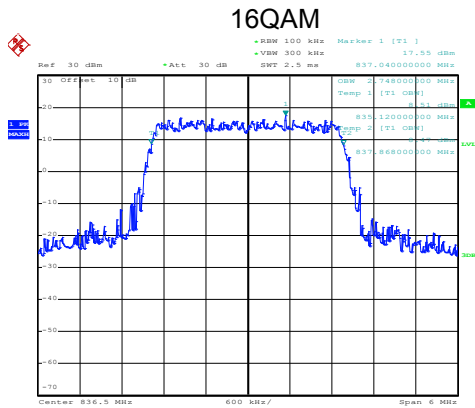

Date: 20.SEP.2019 09:24:47

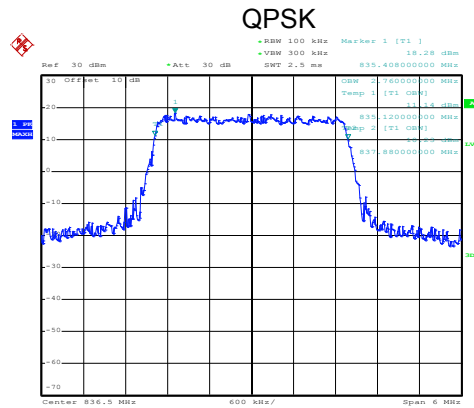

Date: 20.SEP.2019 09:24:42

Middle channel

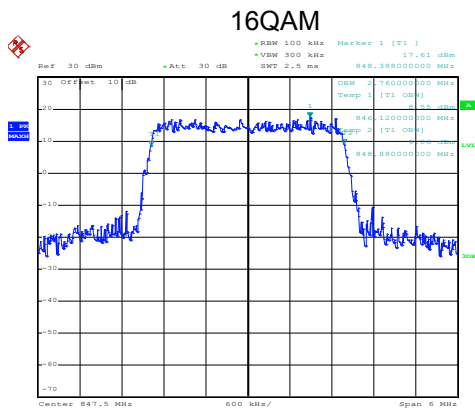

Date: 20.SEP.2019 09:25:28

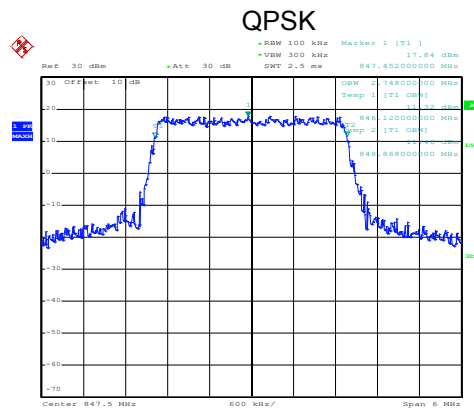

Date: 20.SEP.2019 09:25:25

Highest channel

LTE Band 5: 99% Occupancy bandwidth  
BW: 5MHz

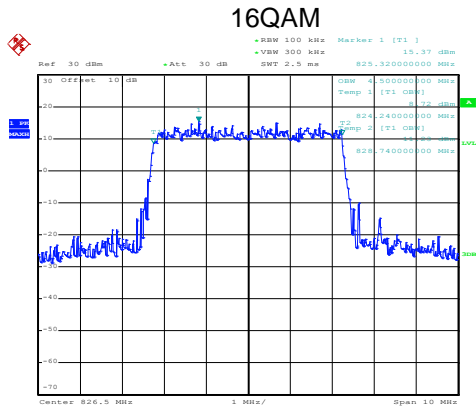

Date: 20.SEP.2019 09:26:07

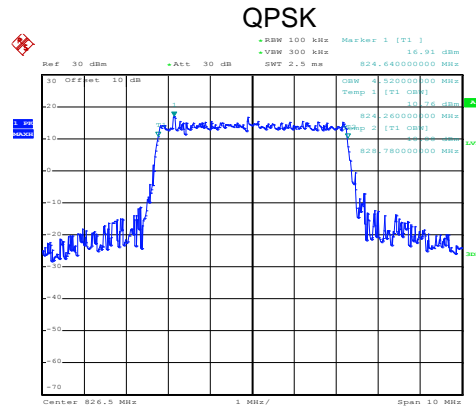

Date: 20.SEP.2019 09:26:04

Lowest channel

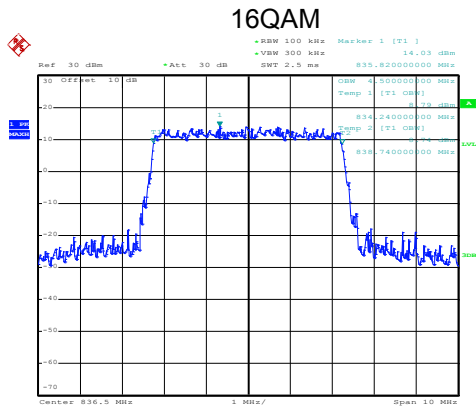

Date: 20.SEP.2019 09:26:47

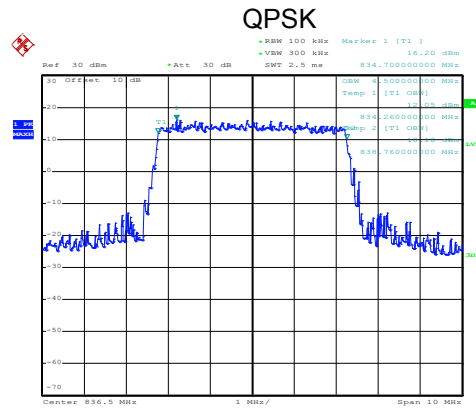

Date: 20.SEP.2019 09:26:43

Middle channel

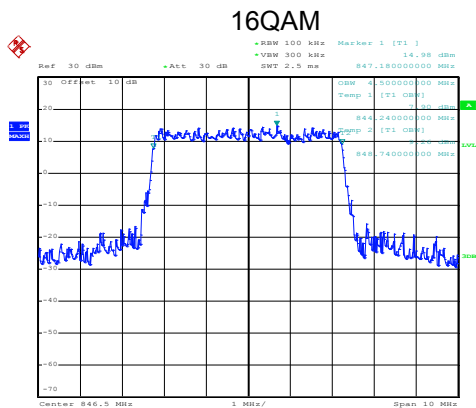

Date: 20.SEP.2019 09:27:03

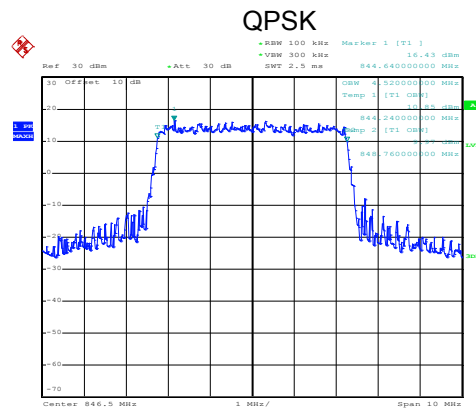

Date: 20.SEP.2019 09:26:59

Highest channel



### LTE Band 5: 99% Occupancy bandwidth BW: 10MHz

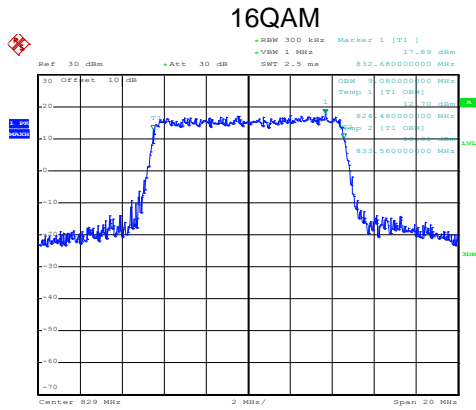

Date: 20.SEP.2019 09:28:06

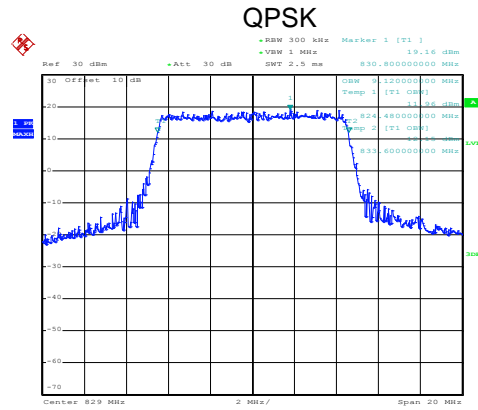

Date: 20.SEP.2019 09:28:01

#### Lowest channel

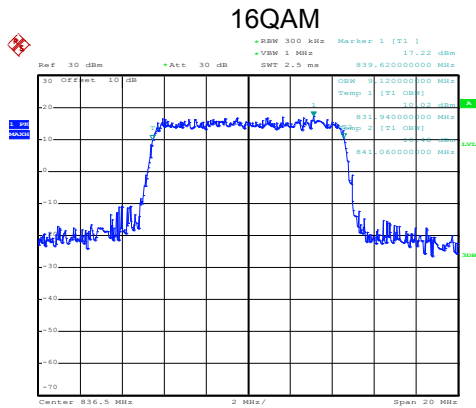

Date: 20.SEP.2019 09:28:24

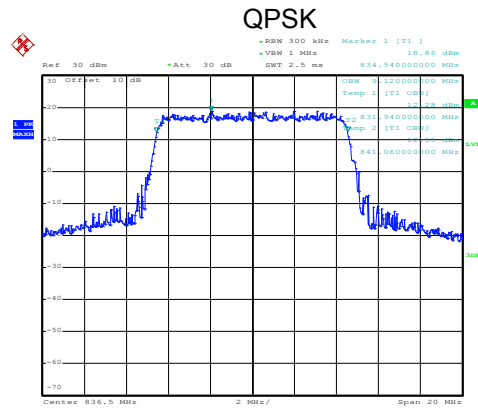

Date: 20.SEP.2019 09:28:20

#### Middle channel

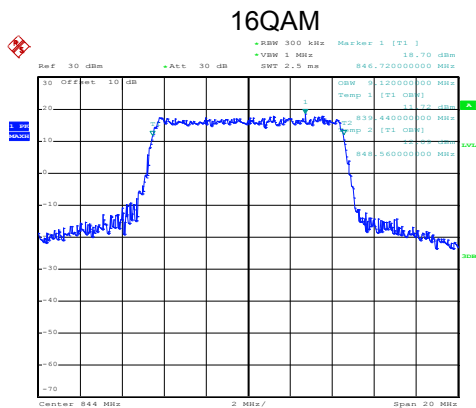

Date: 20.SEP.2019 09:29:20

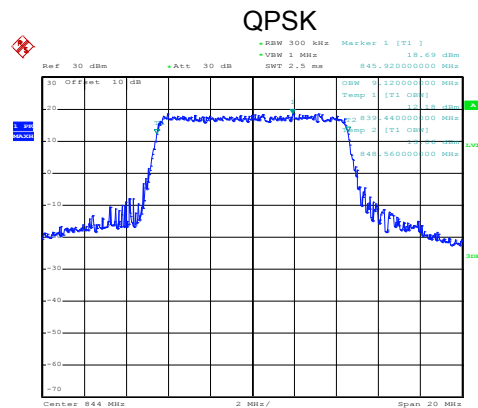

Date: 20.SEP.2019 09:29:13

#### Highest channel

LTE Band 5: -26dBc bandwidth  
BW: 1.4MHz

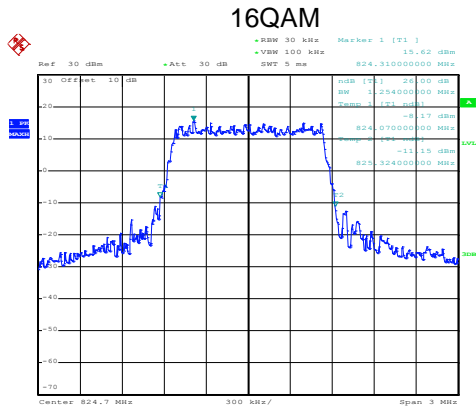

Date: 20.SEP.2019 09:22:42

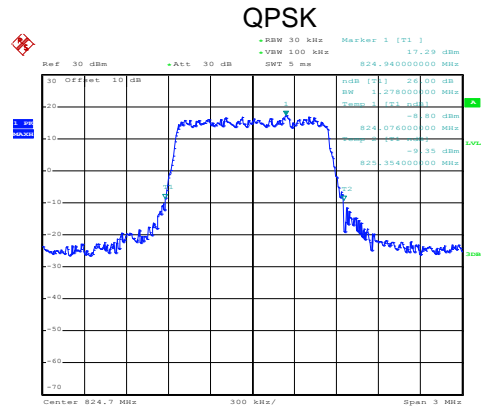

Date: 20.SEP.2019 09:22:39

Lowest channel

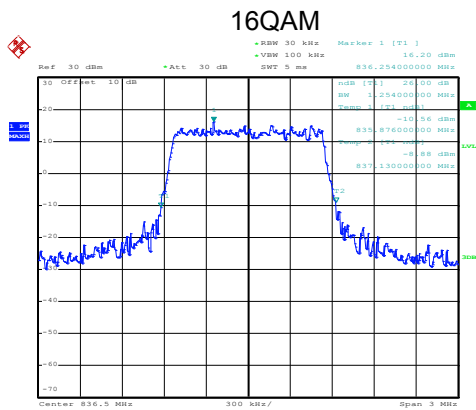

Date: 20.SEP.2019 09:22:59

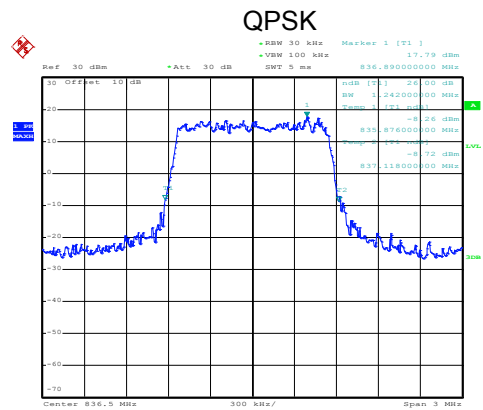

Date: 20.SEP.2019 09:22:55

Middle channel

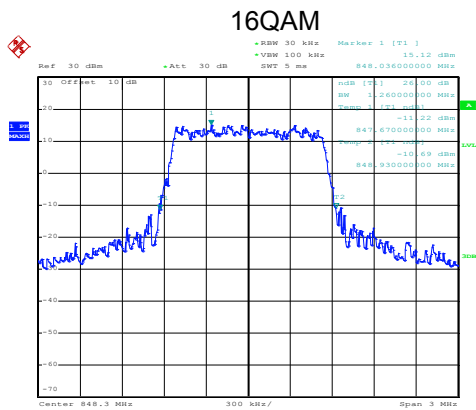

Date: 20.SEP.2019 09:23:36

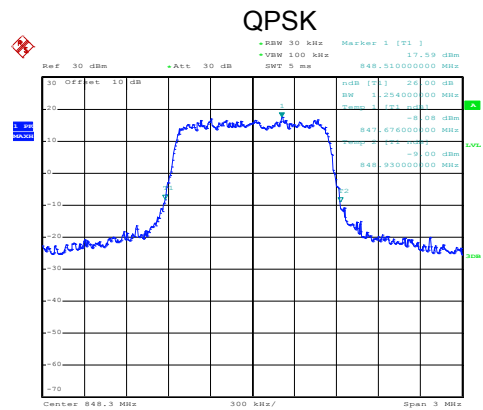

Date: 20.SEP.2019 09:23:33

Highest channel

LTE Band 5: -26dBc bandwidth  
BW: 3MHz

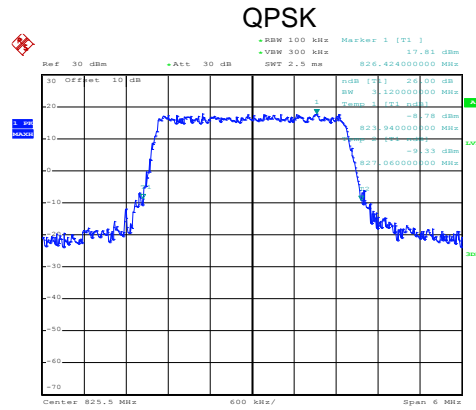
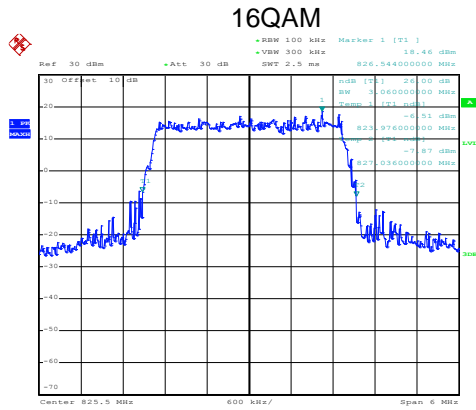

Date: 20.SEP.2019 09:24:20

Date: 20.SEP.2019 09:24:17

Lowest channel

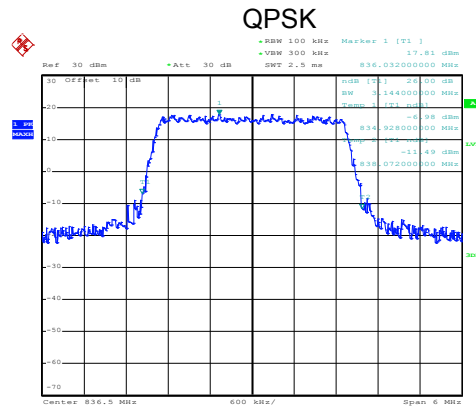
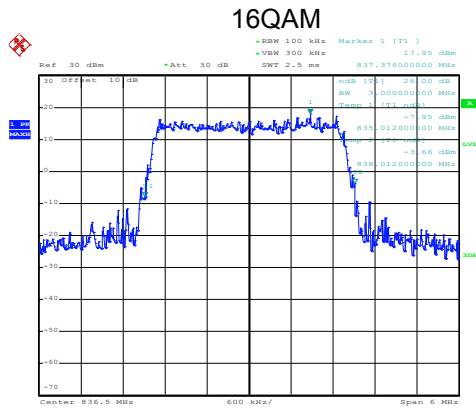

Date: 20.SEP.2019 09:24:58

Date: 20.SEP.2019 09:24:55

Middle channel

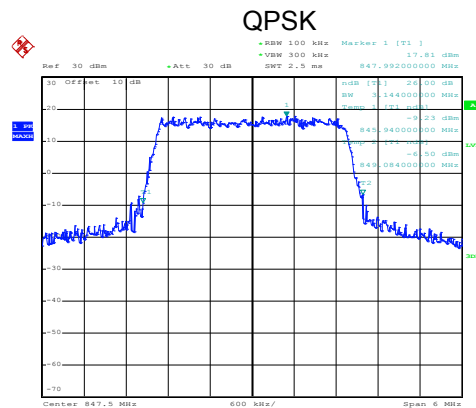
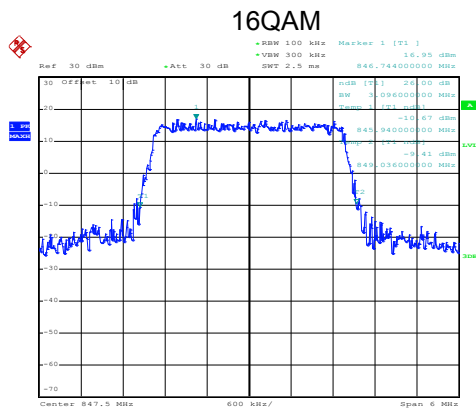

Date: 20.SEP.2019 09:25:17

Date: 20.SEP.2019 09:25:13

Highest channel

LTE Band 5: -26dBc bandwidth  
BW: 5MHz

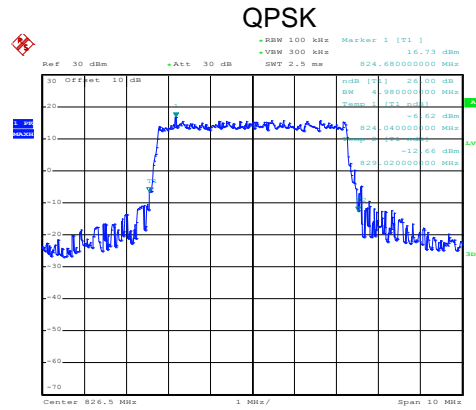
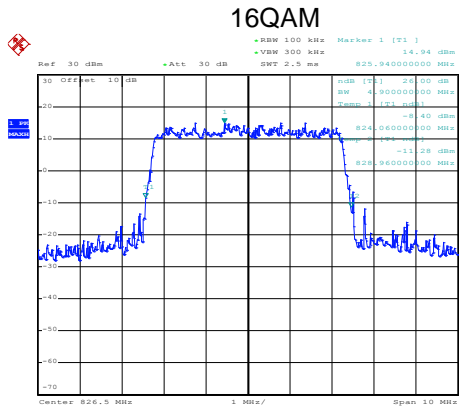

Date: 20.SEP.2019 09:26:21

Date: 20.SEP.2019 09:26:17

Lowest channel

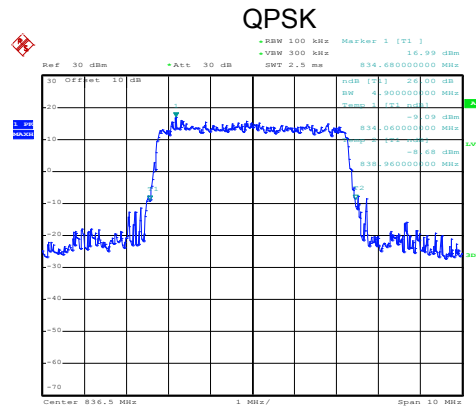
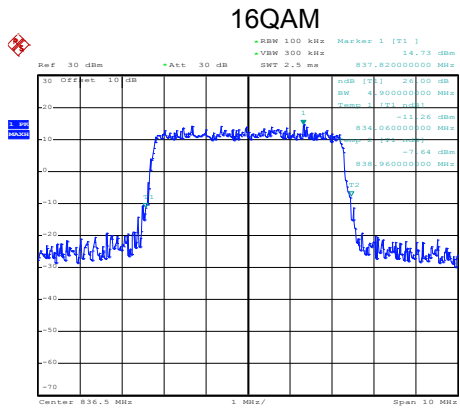

Date: 20.SEP.2019 09:26:36

Date: 20.SEP.2019 09:26:32

Middle channel

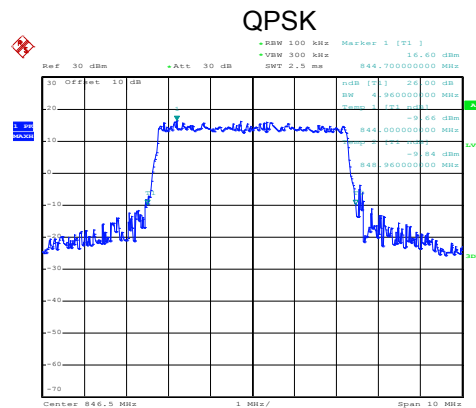
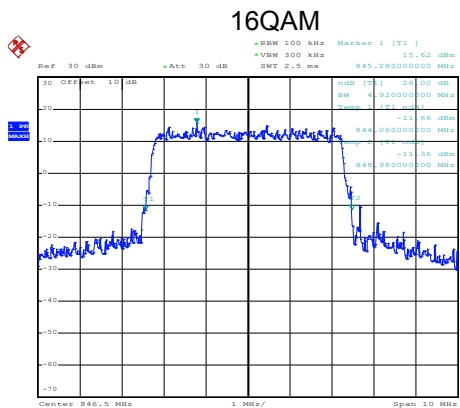

Date: 20.SEP.2019 09:27:15

Date: 20.SEP.2019 09:27:11

Highest channel

LTE Band 5: -26dBc bandwidth  
BW: 10MHz

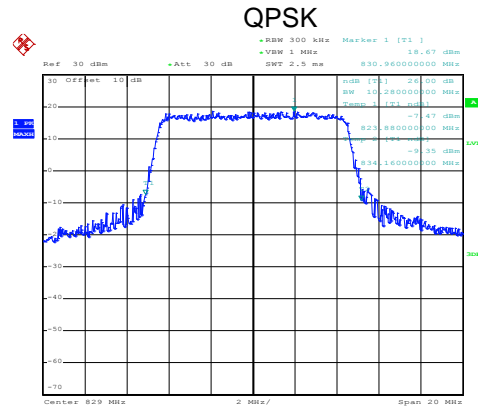
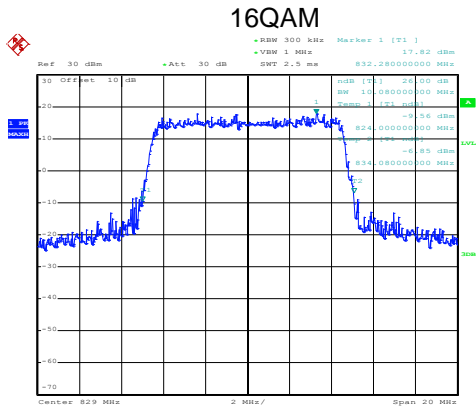

Date: 20.SEP.2019 09:27:52

Date: 20.SEP.2019 09:27:49

Lowest channel

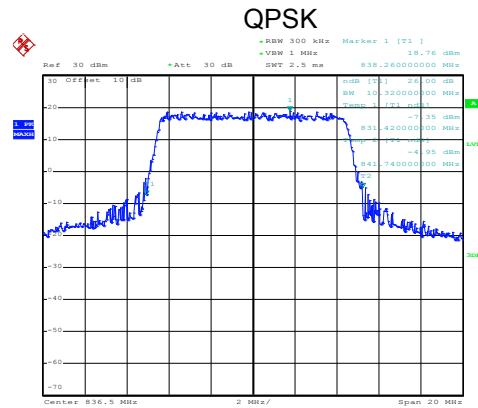
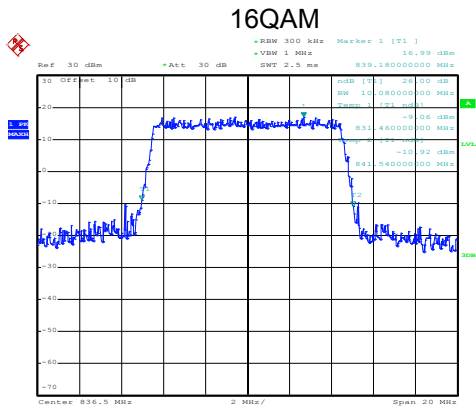

Date: 20.SEP.2019 09:28:37

Date: 20.SEP.2019 09:28:33

Middle channel

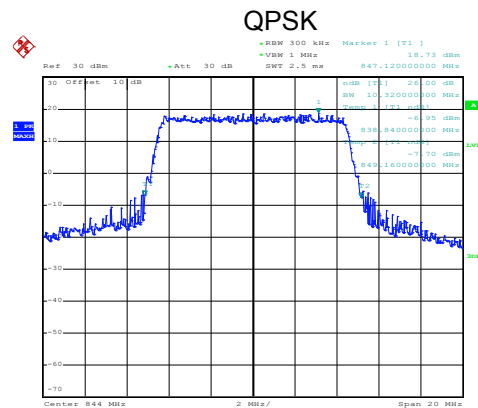
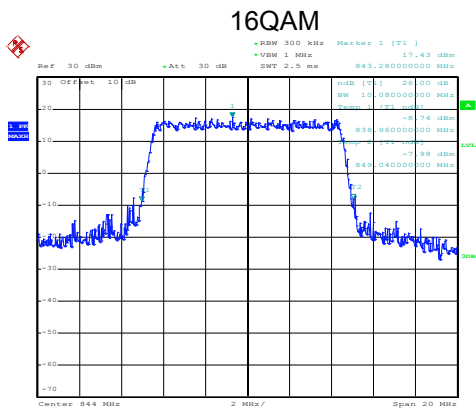

Date: 20.SEP.2019 09:28:55

Date: 20.SEP.2019 09:28:52

Highest channel

## LTE-Band 7 part:

### LTE Band 7: 99% Occupancy bandwidth BW: 5MHz

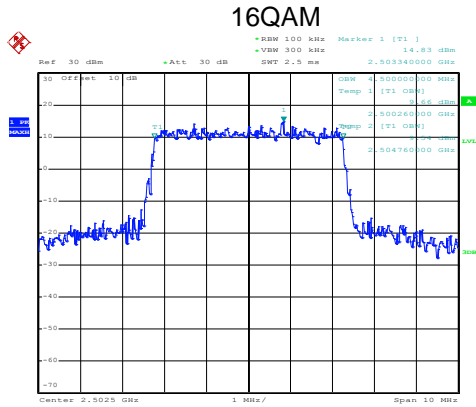

Date: 20.SEP.2019 09:29:58

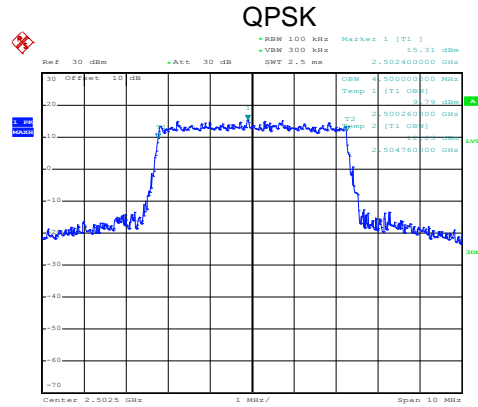

Date: 20.SEP.2019 09:29:54

### Lowest channel

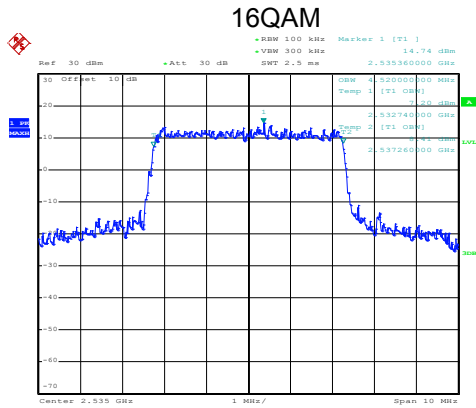

Date: 20.SEP.2019 09:30:44

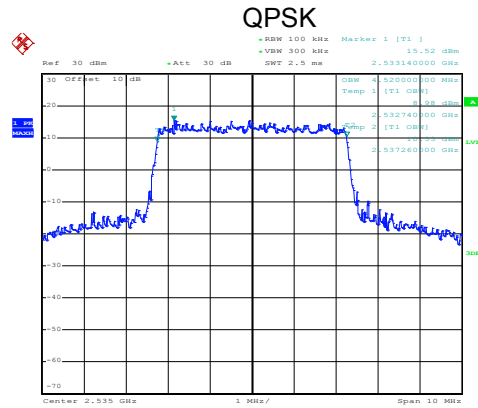

Date: 20.SEP.2019 09:30:39

### Middle channel

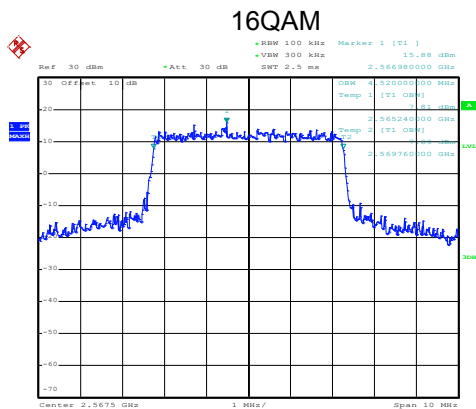

Date: 20.SEP.2019 09:31:03

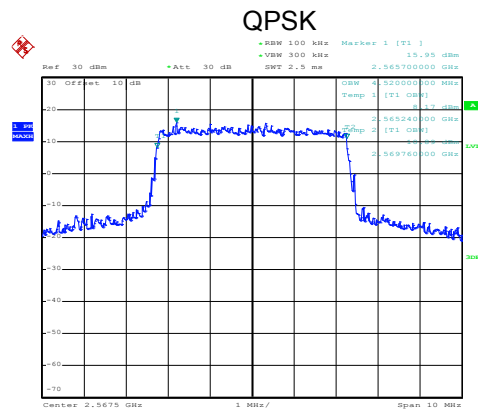

Date: 20.SEP.2019 09:30:59

### Highest channel

LTE Band 7: 99% Occupy bandwidth  
BW: 10MHz

16QAM

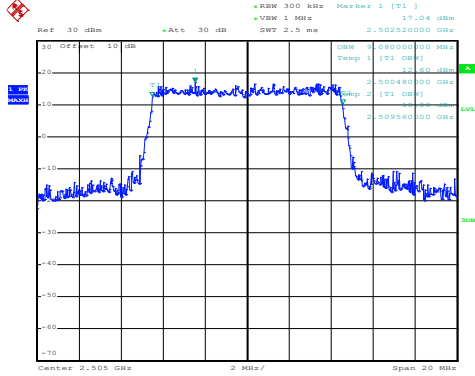

Date: 20.SEP.2019 09:32:01

QPSK

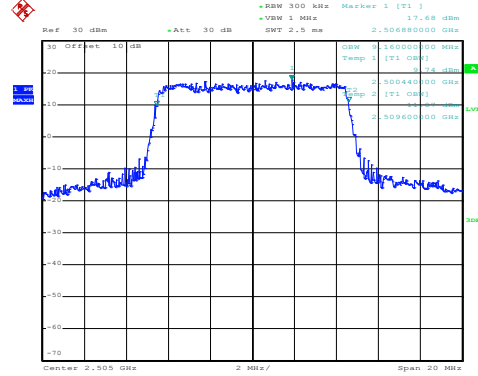

Date: 20.SEP.2019 09:31:57

Lowest channel

16QAM

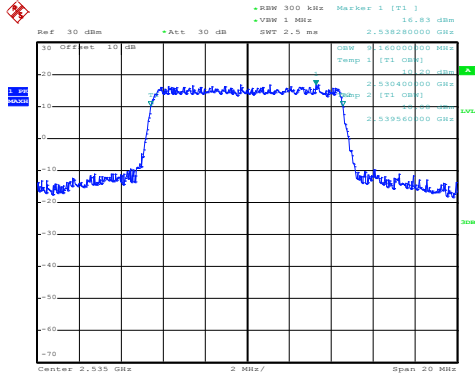

Date: 20.SEP.2019 09:32:20

QPSK

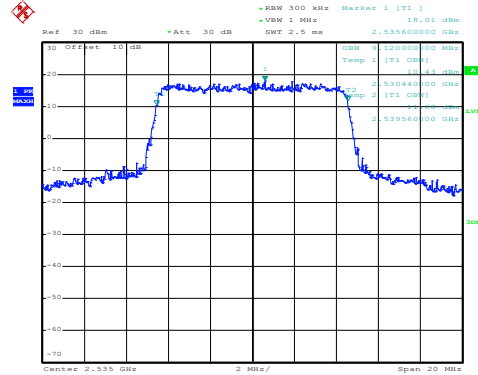

Date: 20.SEP.2019 09:32:14

Middle channel

16QAM

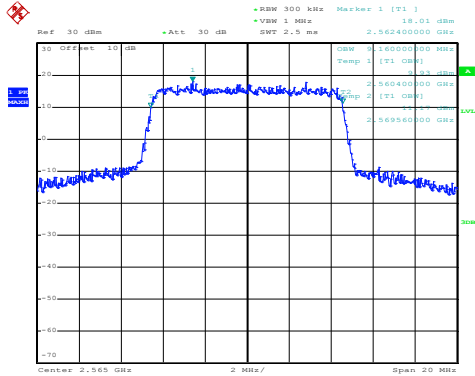

Date: 20.SEP.2019 09:33:03

QPSK

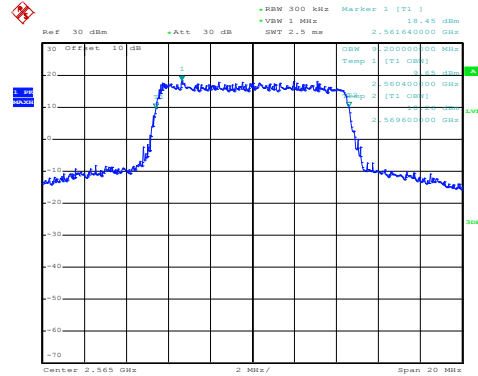

Date: 20.SEP.2019 09:32:58

Highest channel

LTE Band 7: 99% Occupancy bandwidth  
BW: 15MHz

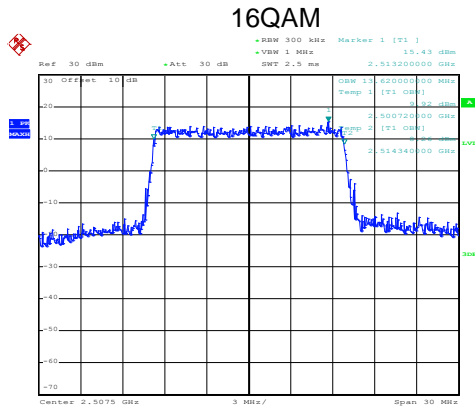

Date: 20.SEP.2019 09:33:35

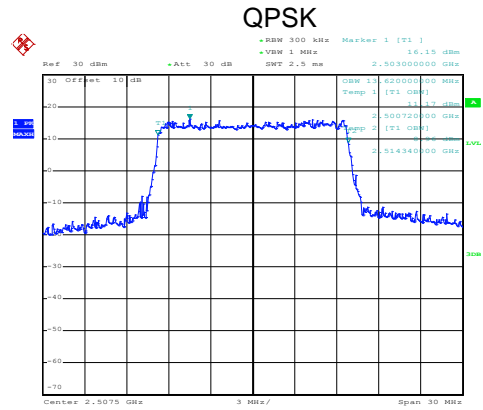

Date: 20.SEP.2019 09:33:31

Lowest channel

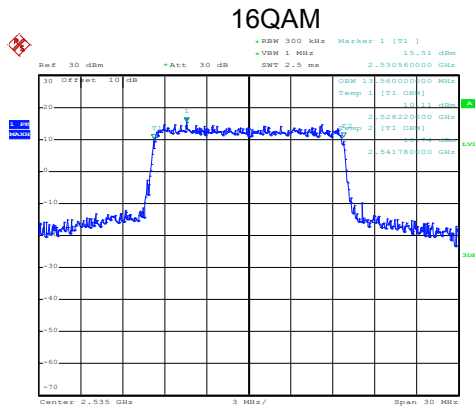

Date: 20.SEP.2019 09:34:14

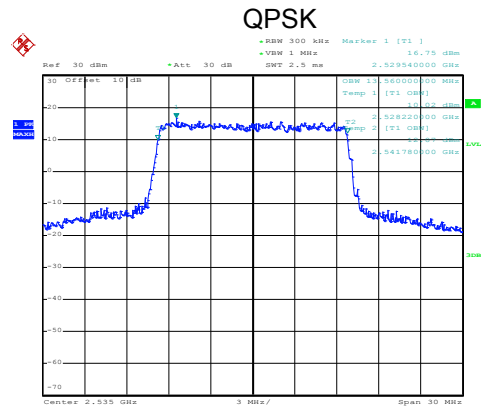

Date: 20.SEP.2019 09:34:10

Middle channel

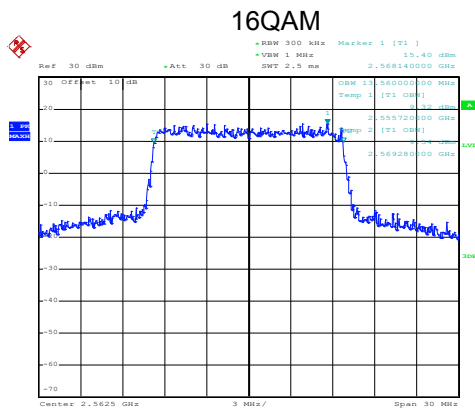

Date: 20.SEP.2019 09:34:33

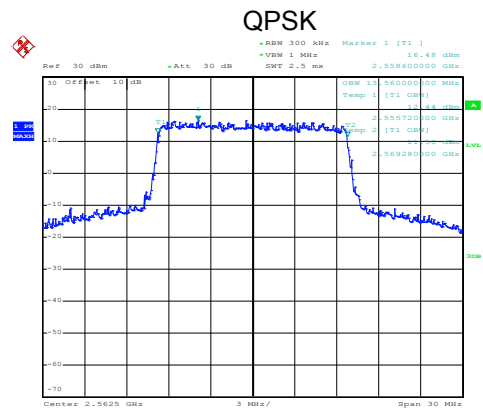

Date: 20.SEP.2019 09:35:01

Highest channel



LTE Band 7: 99% Occupancy bandwidth  
BW: 20MHz

16QAM

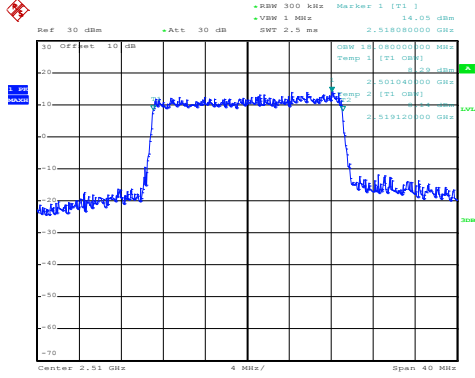

Date: 20.SEP.2019 09:36:16

QPSK

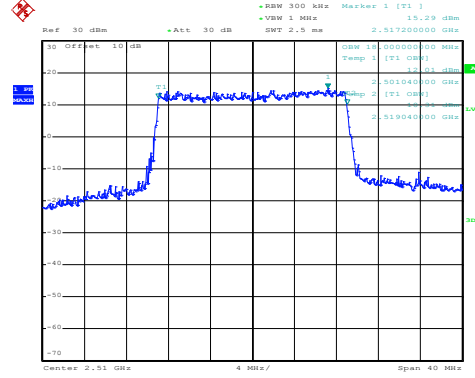

Date: 20.SEP.2019 09:36:12

Lowest channel

16QAM

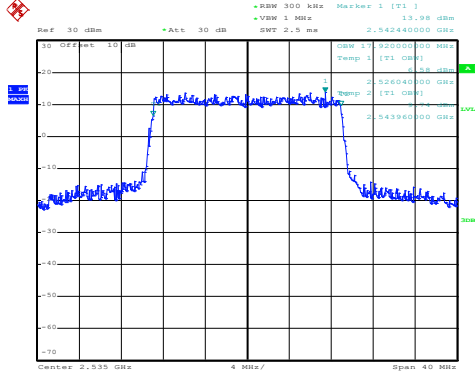

Date: 20.SEP.2019 09:36:57

QPSK

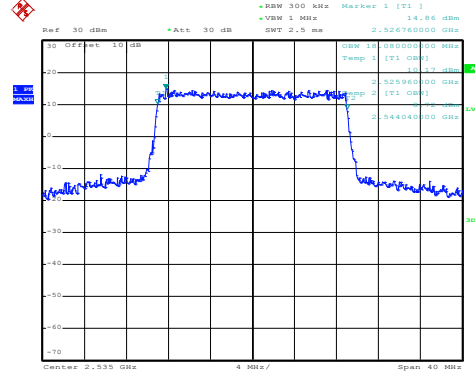

Date: 20.SEP.2019 09:36:53

Middle channel

16QAM

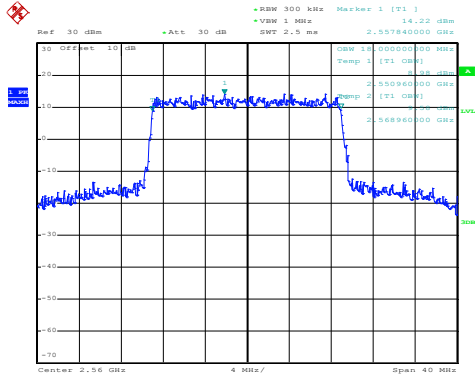

Date: 20.SEP.2019 09:37:16

QPSK

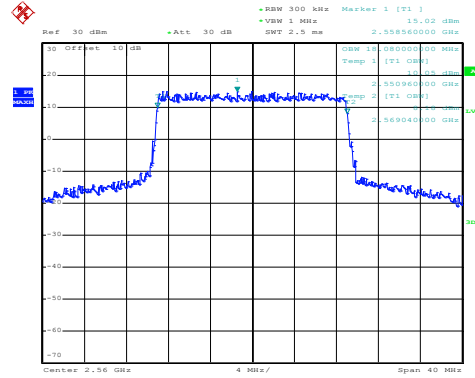

Date: 20.SEP.2019 09:37:12

Highest channel

LTE Band 7: -26dBc bandwidth  
BW: 5MHz

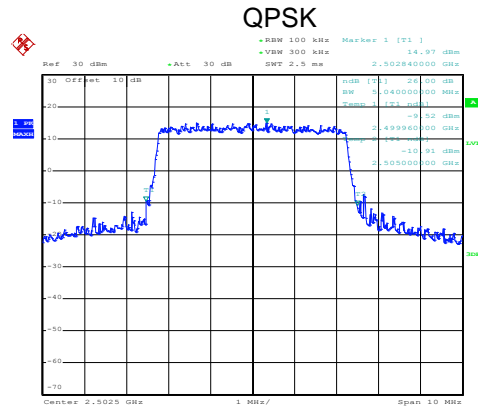
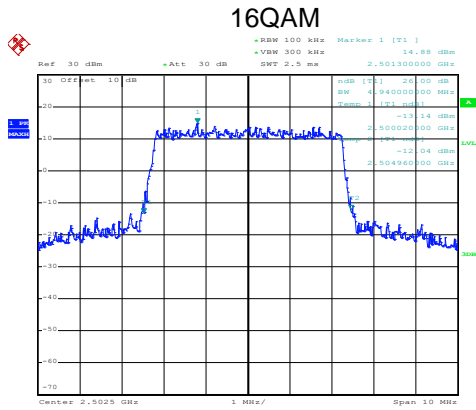

Date: 20.SEP.2019 09:30:12

Date: 20.SEP.2019 09:30:08

Lowest channel

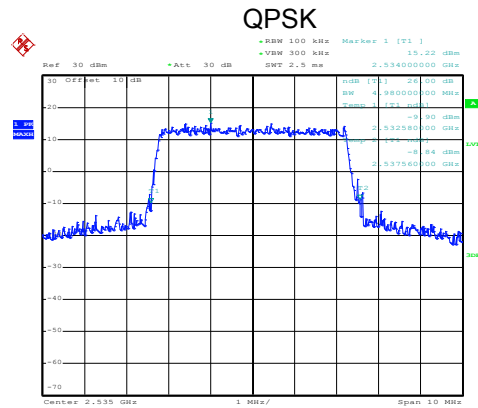
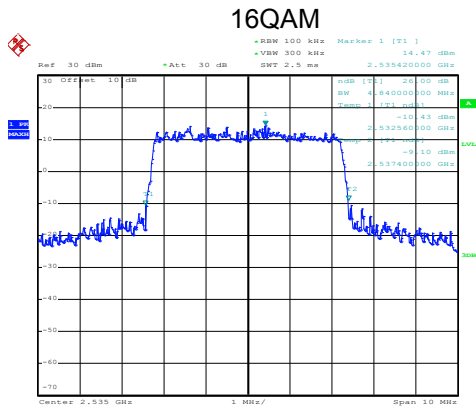

Date: 20.SEP.2019 09:30:31

Date: 20.SEP.2019 09:30:27

Middle channel

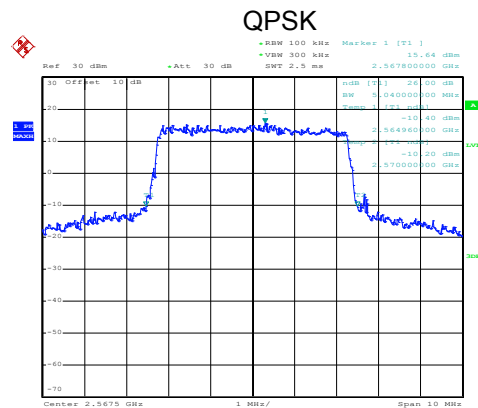
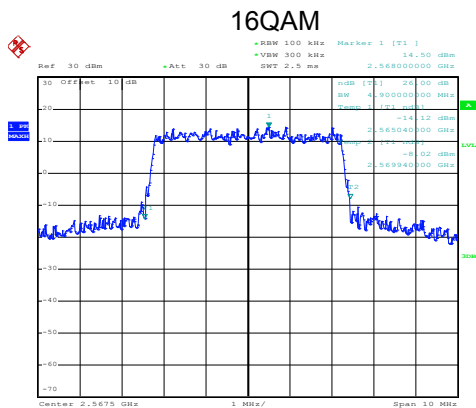

Date: 20.SEP.2019 09:31:16

Date: 20.SEP.2019 09:31:12

Highest channel

LTE Band 7: -26dBc bandwidth  
BW: 10MHz

16QAM

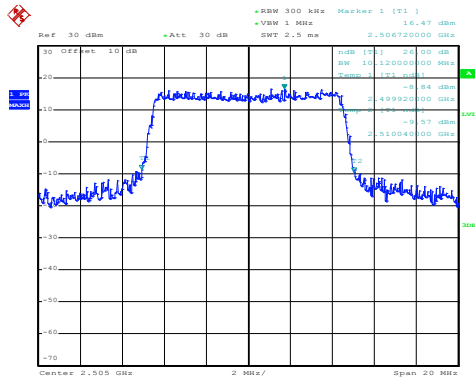

Date: 20.SEP.2019 09:31:49

QPSK

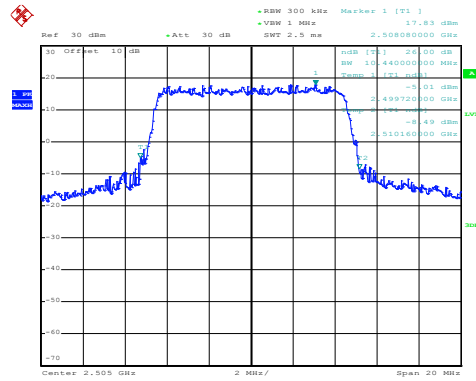

Date: 20.SEP.2019 09:31:45

Lowest channel

16QAM

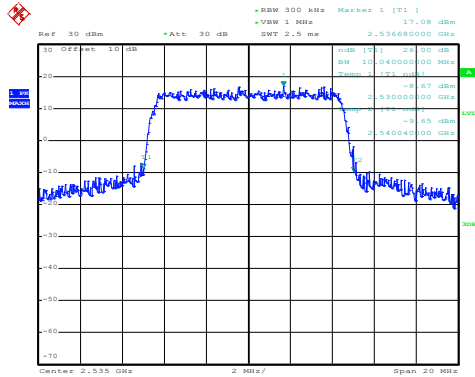

Date: 20.SEP.2019 09:32:31

QPSK

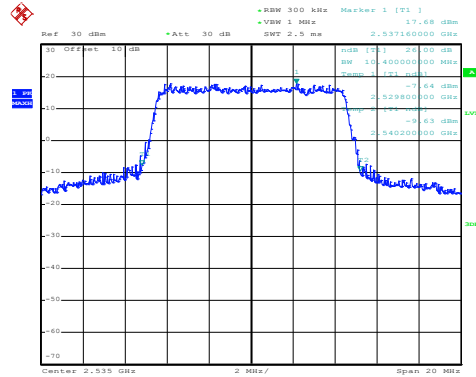

Date: 20.SEP.2019 09:32:27

Middle channel

16QAM

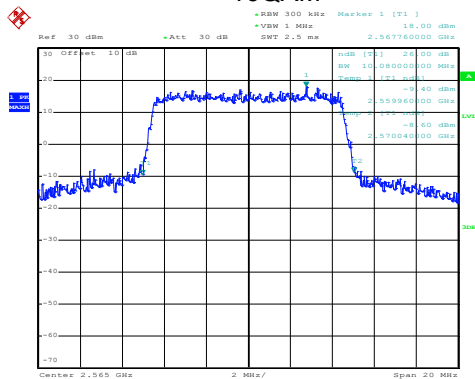

Date: 20.SEP.2019 09:32:49

QPSK

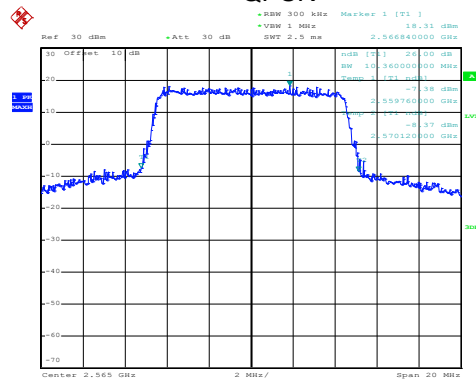

Date: 20.SEP.2019 09:32:46

Highest channel

LTE Band 7: -26dBc bandwidth  
BW: 15MHz

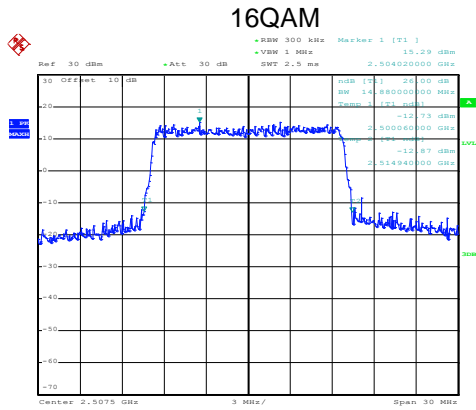

Date: 20.SEP.2019 09:33:48

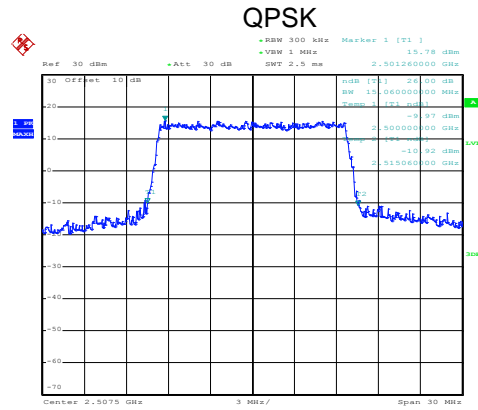

Date: 20.SEP.2019 09:33:44

Lowest channel

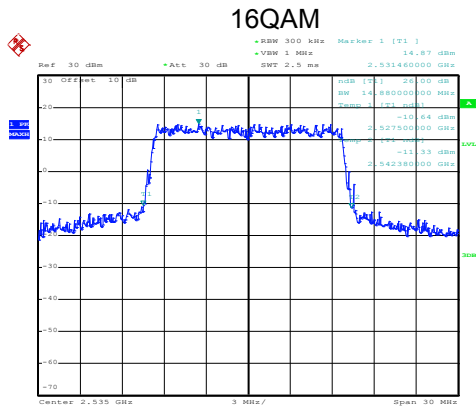

Date: 20.SEP.2019 09:34:02

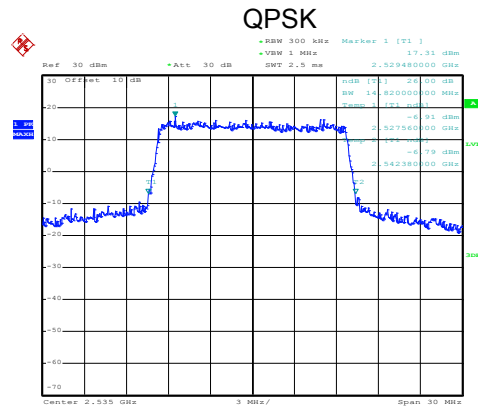

Date: 20.SEP.2019 09:33:58

Middle channel

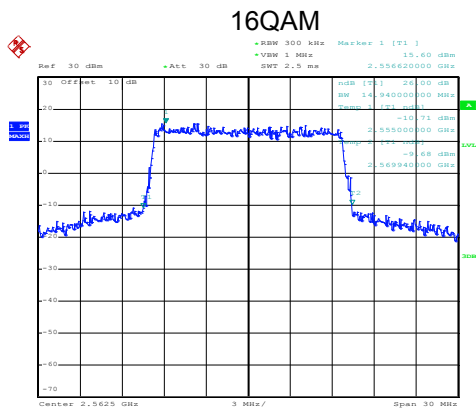

Date: 20.SEP.2019 09:34:49

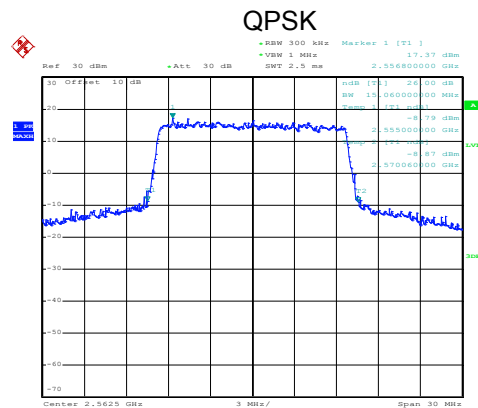

Date: 20.SEP.2019 09:34:43

Highest channel

LTE Band 7: -26dBc bandwidth  
BW: 20MHz

16QAM

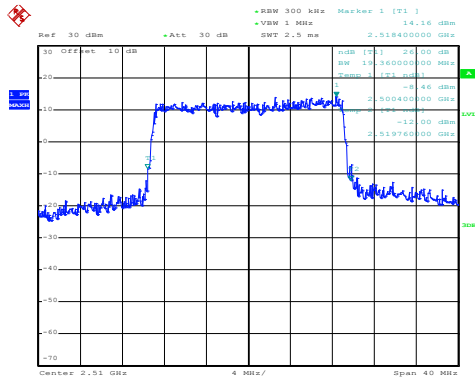

Date: 20.SEP.2019 09:36:28

QPSK

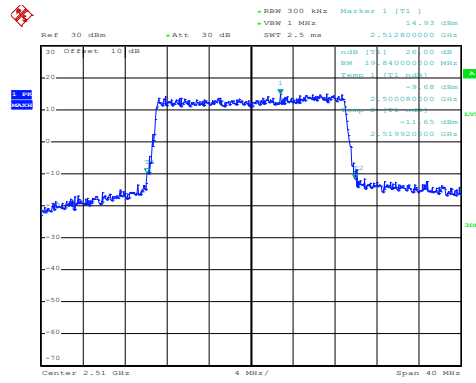

Date: 20.SEP.2019 09:36:24

Lowest channel

16QAM

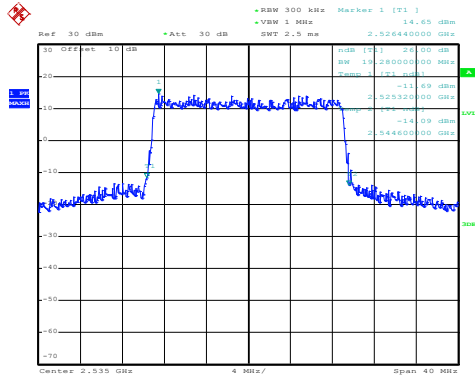

Date: 20.SEP.2019 09:36:44

QPSK

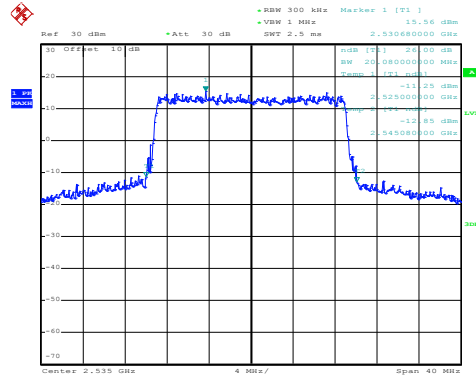

Date: 20.SEP.2019 09:36:40

Middle channel

16QAM

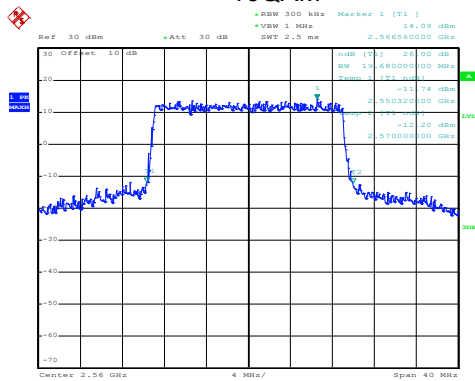

Date: 20.SEP.2019 09:37:28

QPSK

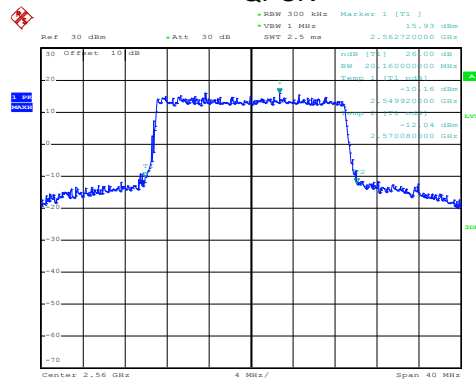

Date: 20.SEP.2019 09:37:24

Highest channel

## 6.4 Out of band emission at antenna terminals

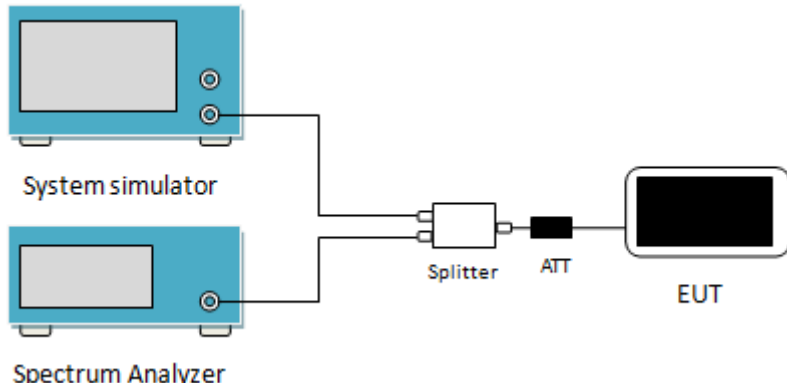
Test Requirement:	Part 22.917(b), Part 24.238 (a), part 27.53(g), part 27.53(h), Part 27.53(m)
Limit:	<p>LTE Band 4 &amp; 5 &amp;: The power of any emission outside a licensee's frequency block shall be attenuated below the transmitter power (P) in watts by at least <math>43 + 10 \log_{10}(P)</math> dB (-13 dBm).</p> <p>LTE Band 7: For mobile digital stations, the attenuation factor shall be not less than <math>40 + 10 \log (P)</math> dB on all frequencies between the channel edge and 5 megahertz from the channel edge, <math>43 + 10 \log (P)</math> dB on all frequencies between 5 megahertz and X megahertz from the channel edge, and <math>55 + 10 \log (P)</math> dB on all frequencies more than X megahertz from the channel edge, where X is the greater of 6 megahertz or the actual emission bandwidth as defined in paragraph (m)(6) of this section. In addition, the attenuation factor shall not be less that <math>43 + 10 \log (P)</math> dB on all frequencies between 2490.5 MHz and 2496 MHz and <math>55 + 10 \log (P)</math> dB at or below 2490.5 MHz.</p>
Test Setup:	
Test Procedure:	<ol style="list-style-type: none"> <li>1 The RF output of the transceiver was connected to a spectrum analyzer through appropriate attenuation.</li> <li>2 The resolution bandwidth of the spectrum analyzer was set at 100 kHz when below 1GHz, 1MHz when above 1 GHz; sufficient scans were taken to show the out of band Emissions if any up to 10th harmonic.</li> <li>3 For the out of band: Set the RBW=100 kHz, VBW=300 kHz when below 1 GHz, RBW =1 MHz, VBW=3 MHz when above 1 GHz, Start=30MHz, Stop= 10th harmonic.</li> <li>4 Band Edge Requirements: In the 1 MHz bands immediately outside and adjacent to the frequency block, a resolution bandwidth of at least 1 percent of the emission bandwidth of the fundamental emission of the transmitter may be employed to measure the out of band Emissions.</li> </ol>
Test Instruments:	Refer to section 5.10 for details
Test mode:	Refer to section 5.3 for details
Test results:	Passed
Remark:	Pre-scan all RB Size and offset, and found the RB Size and offset of worst case, so the report shows only the worst case test data.

Test plots as follows (Conducted spurious emission) (worst case):  
 LTE Band 4 part:

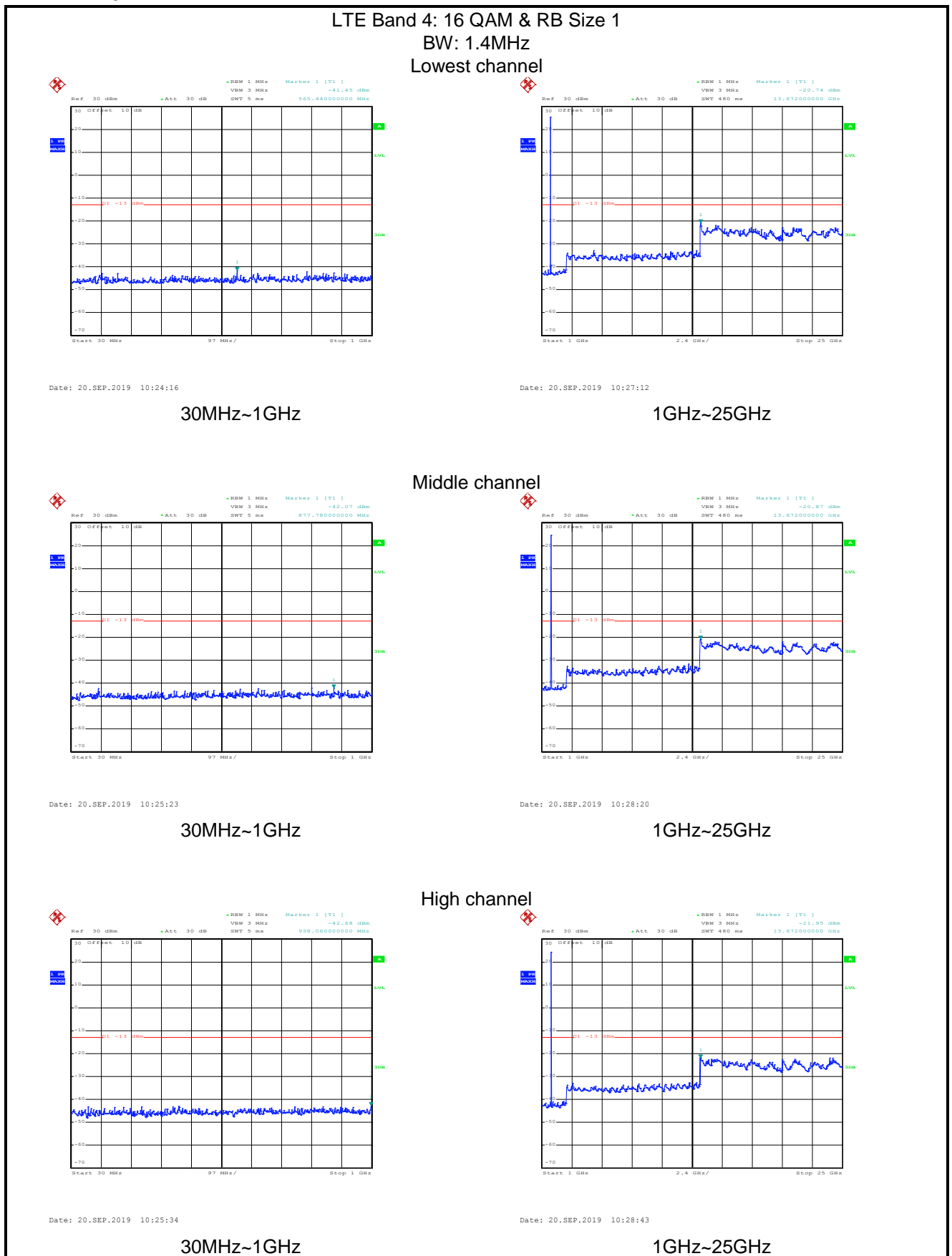

## LTE Band 4: 16 QAM & RB Size 6 BW: 1.4MHz Lowest channel

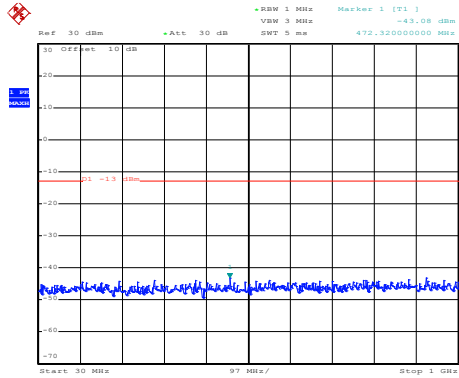

Date: 20.SEP.2019 10:24:30

30MHz~1GHz

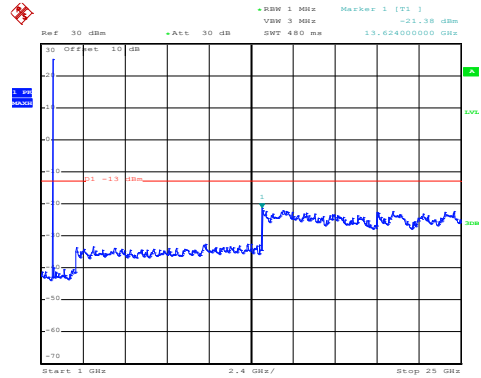

Date: 20.SEP.2019 10:27:34

1GHz~25GHz

## Middle channel

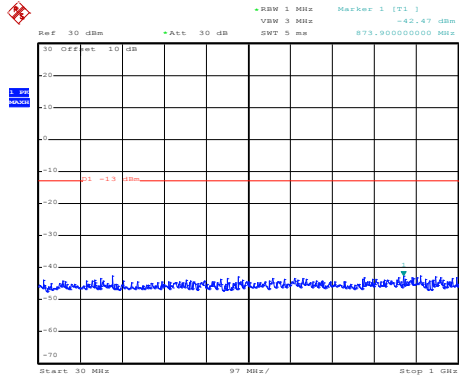

Date: 20.SEP.2019 10:25:07

30MHz~1GHz

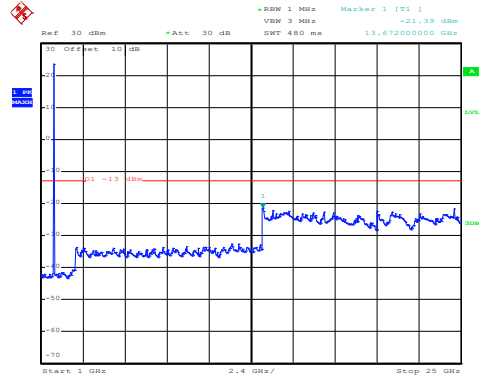

Date: 20.SEP.2019 10:27:56

1GHz~25GHz

## High channel

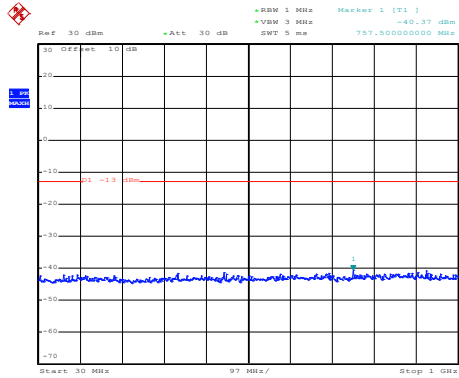

Date: 20.SEP.2019 13:37:31

30MHz~1GHz

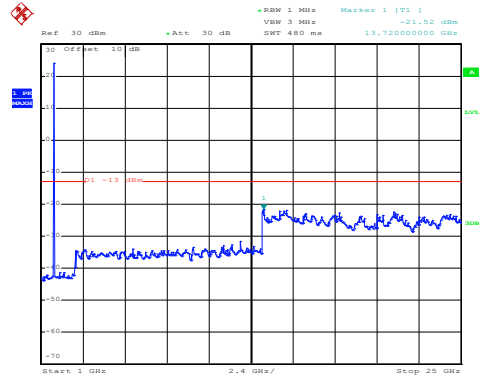

Date: 20.SEP.2019 10:29:02

1GHz~25GHz



## LTE Band 4: QPSK & RB Size 1 BW: 1.4MHz Lowest channel

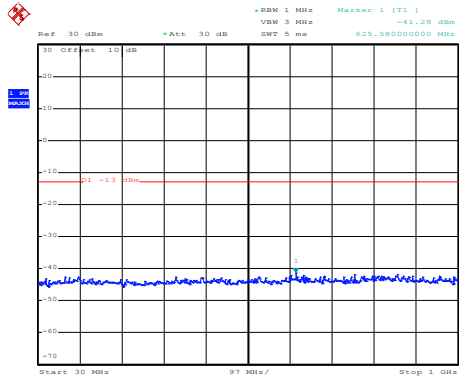

Date: 20.SEP.2019 10:24:09

30MHz~1GHz

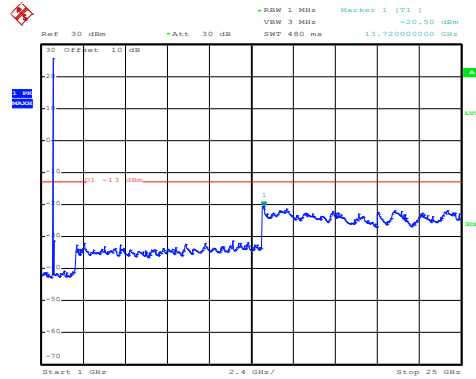

Date: 20.SEP.2019 10:27:06

1GHz~25GHz

## Middle channel

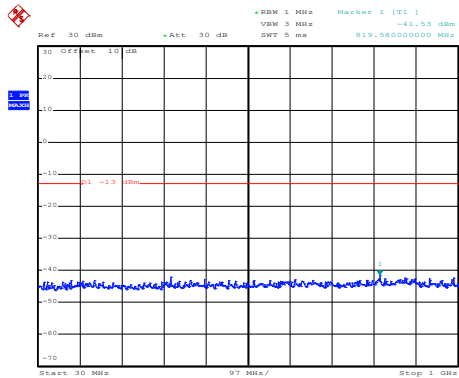

Date: 20.SEP.2019 10:25:19

30MHz~1GHz

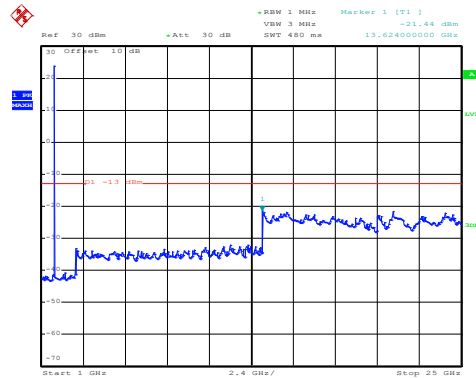

Date: 20.SEP.2019 10:28:06

1GHz~25GHz

## High channel

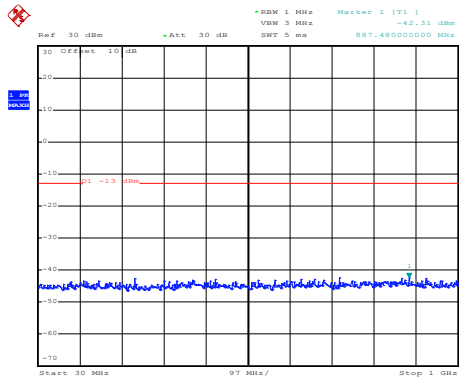

Date: 20.SEP.2019 10:25:29

30MHz~1GHz

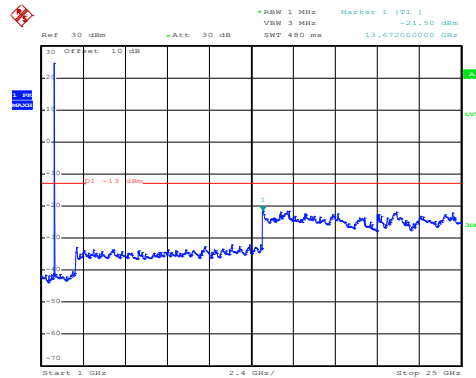

Date: 20.SEP.2019 10:28:34

1GHz~25GHz

## LTE Band 4: QPSK & RB Size 6

BW: 1.4MHz

Lowest channel

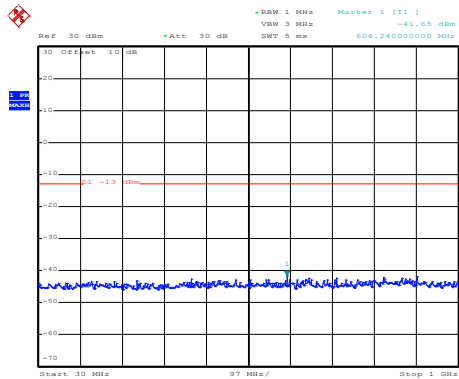

Date: 20.SEP.2019 10:24:25

30MHz~1GHz

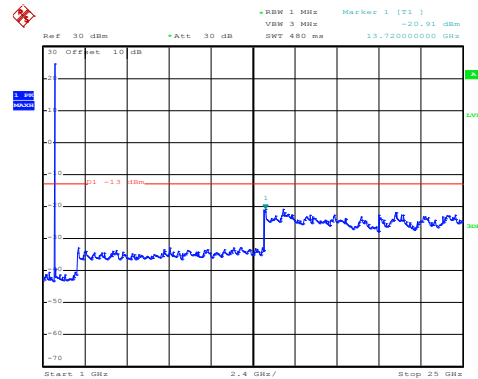

Date: 20.SEP.2019 10:27:22

1GHz~25GHz

Middle channel

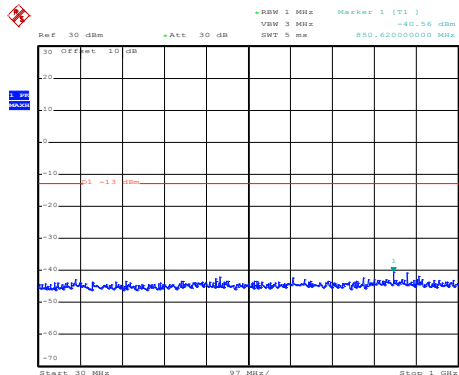

Date: 20.SEP.2019 10:25:03

30MHz~1GHz

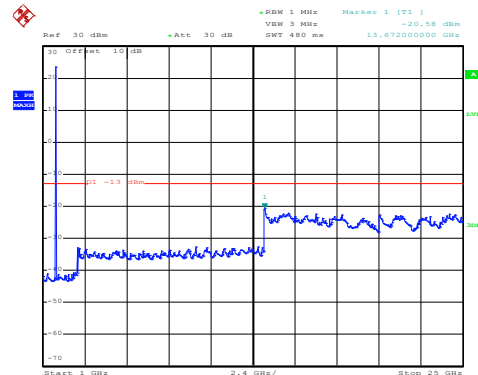

Date: 20.SEP.2019 10:27:48

1GHz~25GHz

High channel

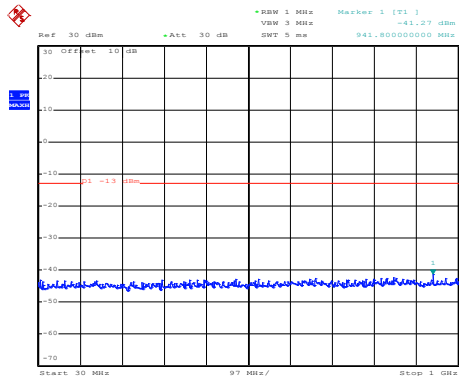

Date: 20.SEP.2019 10:25:42

30MHz~1GHz

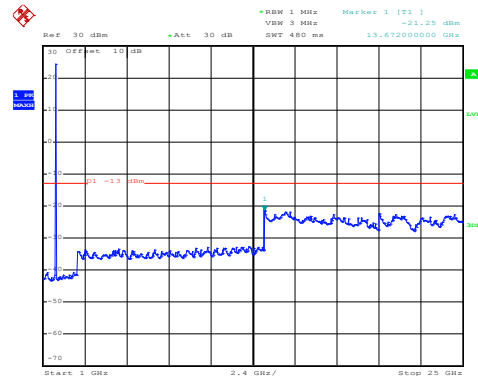

Date: 20.SEP.2019 10:28:55

1GHz~25GHz

## LTE Band 4: 16 QAM & RB Size 1 BW: 3MHz Lowest channel

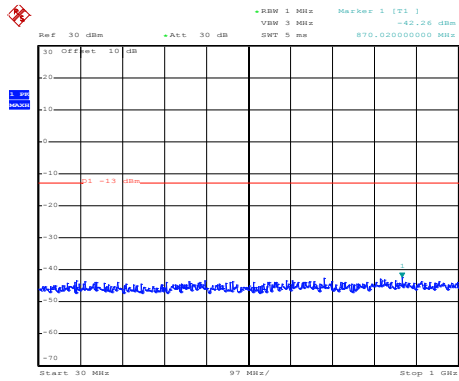

Date: 20.SEP.2019 10:22:04

30MHz~1GHz

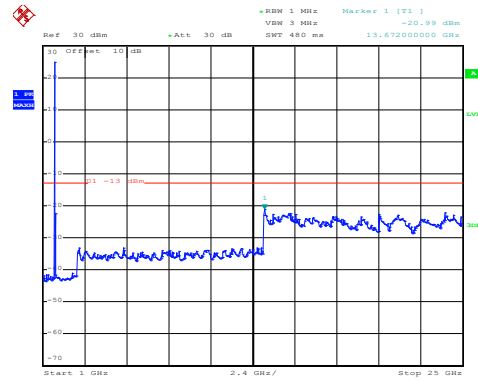

Date: 20.SEP.2019 10:29:34

1GHz~25GHz

## Middle channel

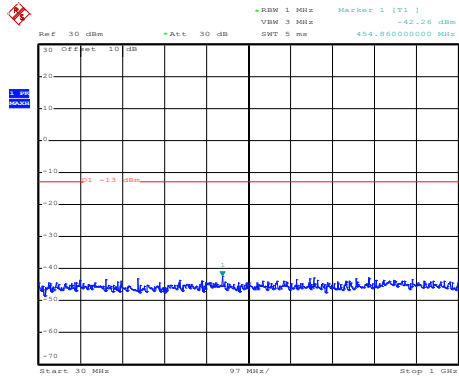

Date: 20.SEP.2019 10:22:44

30MHz~1GHz

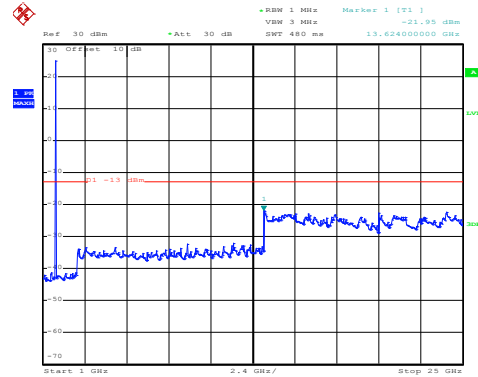

Date: 20.SEP.2019 10:31:02

1GHz~25GHz

## High channel

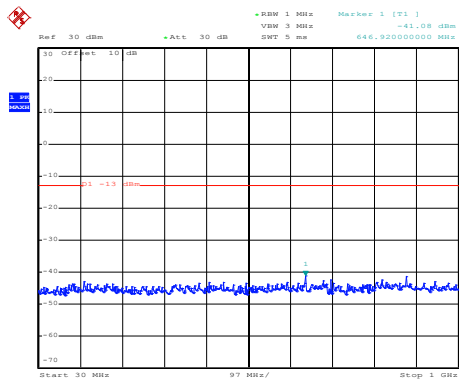

Date: 20.SEP.2019 10:22:59

30MHz~1GHz

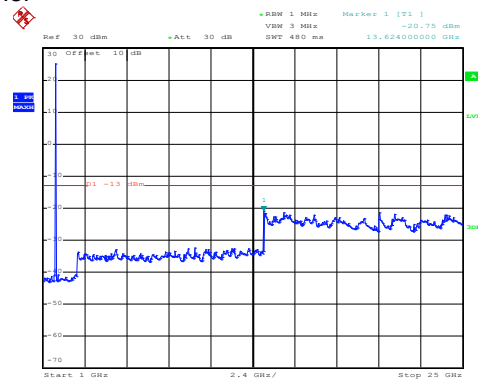

Date: 20.SEP.2019 10:31:30

1GHz~25GHz

LTE Band 4: 16 QAM & RB Size 15  
 BW: 3MHz  
 Lowest channel

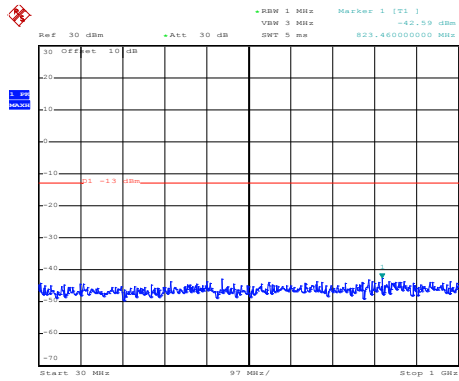

Date: 20.SEP.2019 10:22:17

30MHz~1GHz

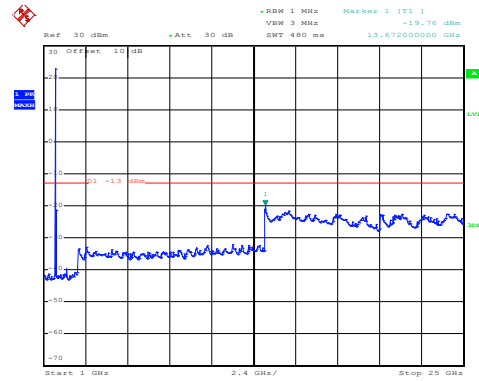

Date: 20.SEP.2019 10:30:04

1GHz~25GHz

Middle channel

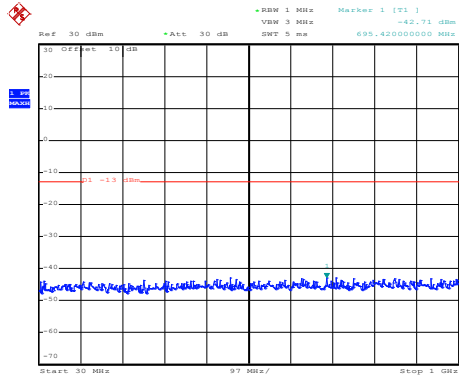

Date: 20.SEP.2019 10:22:31

30MHz~1GHz

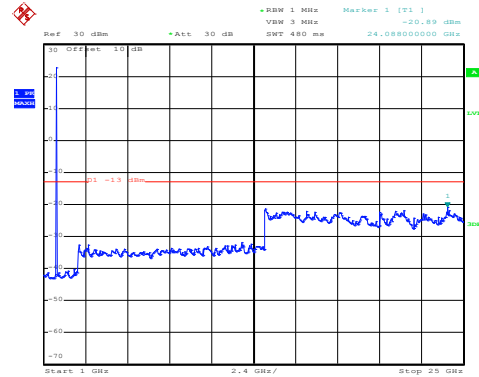

Date: 20.SEP.2019 10:30:36

1GHz~25GHz

High channel

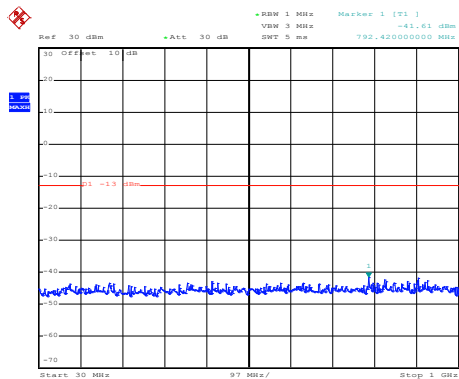

Date: 20.SEP.2019 10:23:11

30MHz~1GHz

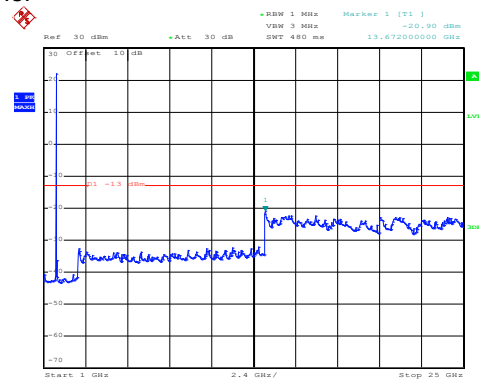

Date: 20.SEP.2019 10:31:49

1GHz~25GHz

## LTE Band 4: QPSK & RB Size 1 BW: 3MHz Lowest channel

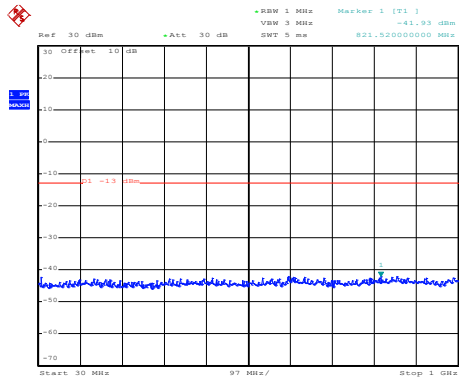

Date: 20.SEP.2019 10:22:00

30MHz~1GHz

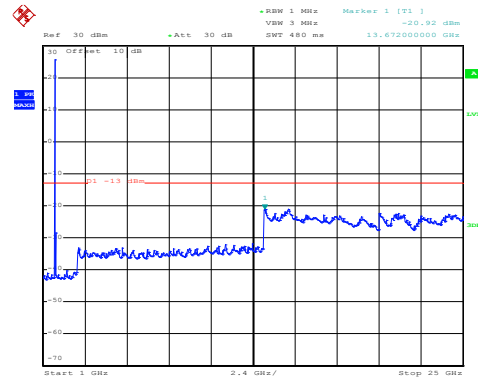

Date: 20.SEP.2019 10:29:28

1GHz~25GHz

## Middle channel

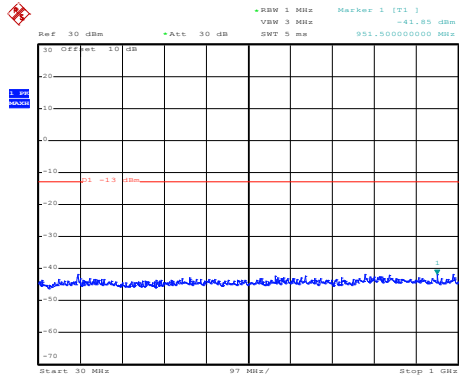

Date: 20.SEP.2019 10:22:40

30MHz~1GHz

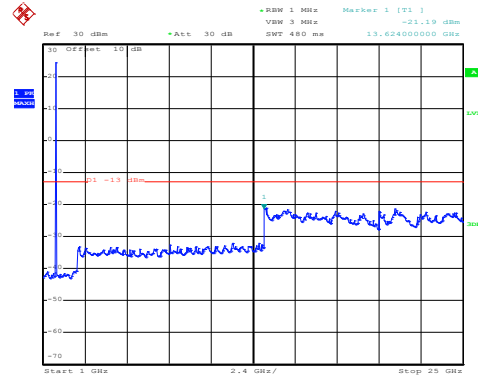

Date: 20.SEP.2019 10:30:55

1GHz~25GHz

## High channel

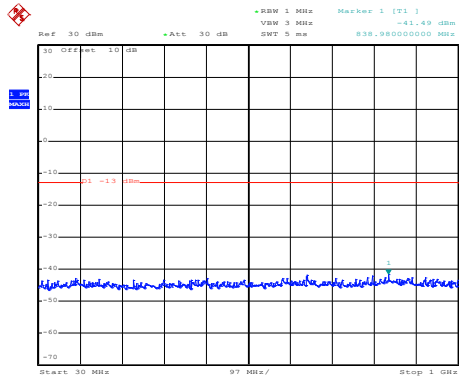

Date: 20.SEP.2019 10:22:54

30MHz~1GHz

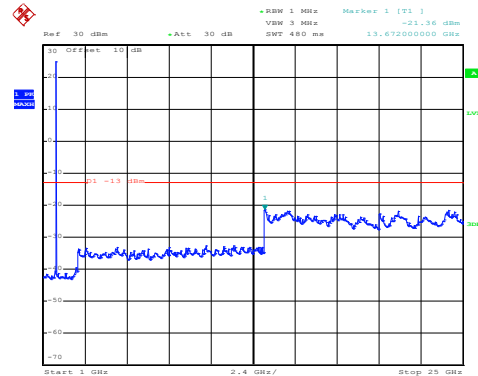

Date: 20.SEP.2019 10:31:18

1GHz~25GHz

## LTE Band 4: QPSK & RB Size 15 BW: 3MHz Lowest channel

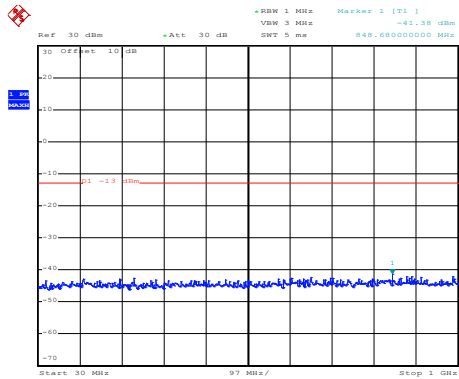

Date: 20.SEP.2019 10:22:13

30MHz~1GHz

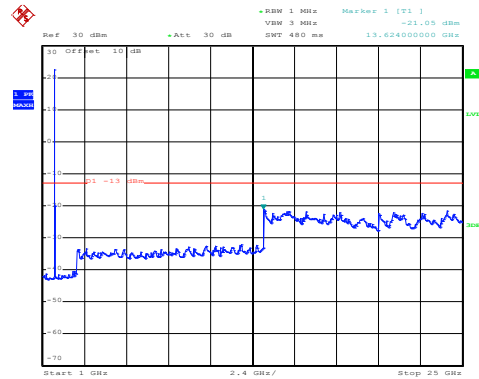

Date: 20.SEP.2019 10:29:48

1GHz~25GHz

## Middle channel

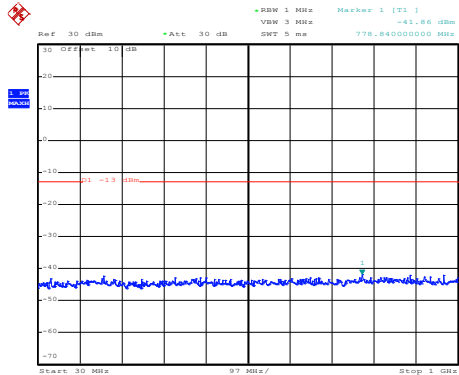

Date: 20.SEP.2019 10:22:27

30MHz~1GHz

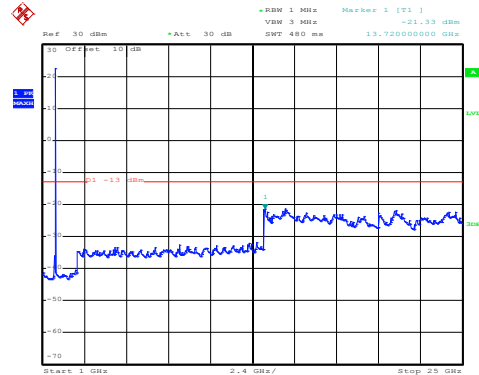

Date: 20.SEP.2019 10:30:19

1GHz~25GHz

## High channel

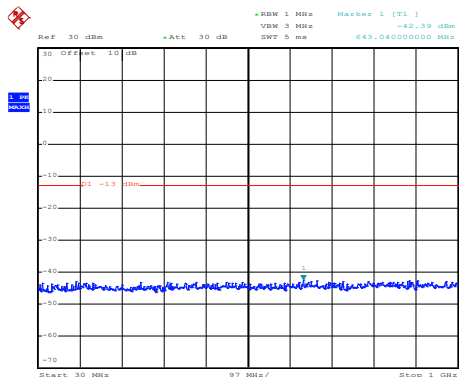

Date: 20.SEP.2019 10:23:07

30MHz~1GHz

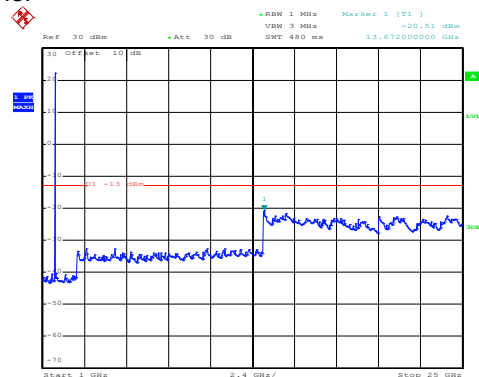

Date: 20.SEP.2019 10:31:41

1GHz~25GHz

## LTE Band 4: 16 QAM & RB Size 1 BW: 5MHz Lowest channel

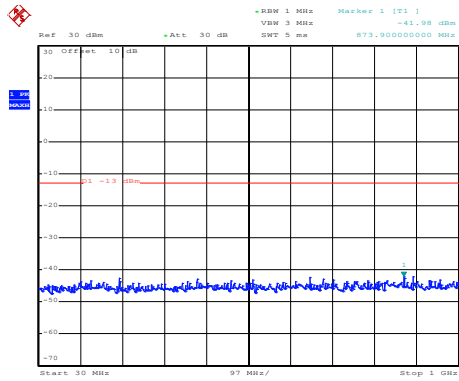

Date: 20.SEP.2019 10:20:15

30MHz~1GHz

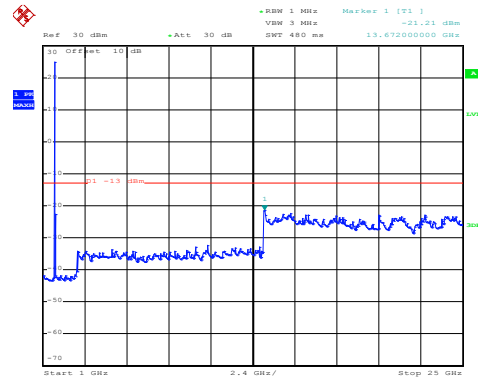

Date: 20.SEP.2019 10:32:59

1GHz~25GHz

## Middle channel

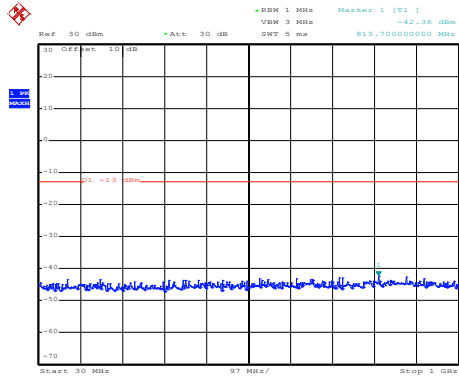

Date: 20.SEP.2019 10:21:02

30MHz~1GHz

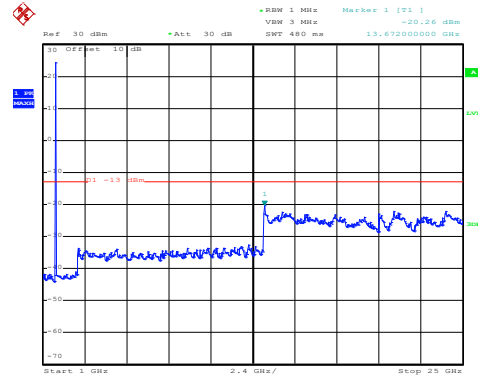

Date: 20.SEP.2019 10:33:53

1GHz~25GHz

## High channel

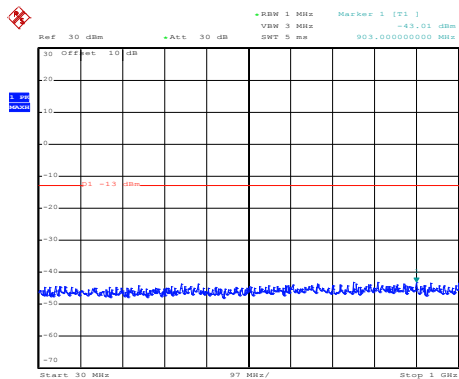

Date: 20.SEP.2019 10:21:15

30MHz~1GHz

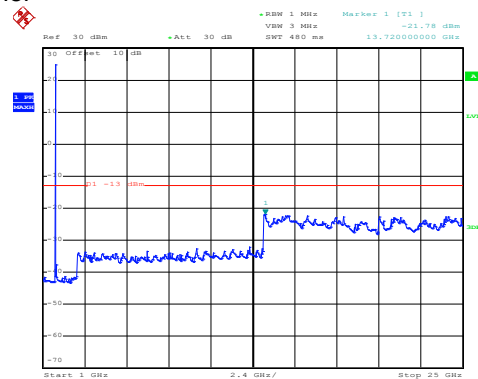

Date: 20.SEP.2019 10:34:27

1GHz~25GHz

## LTE Band 4: 16 QAM & RB Size 25 BW: 5MHz Lowest channel

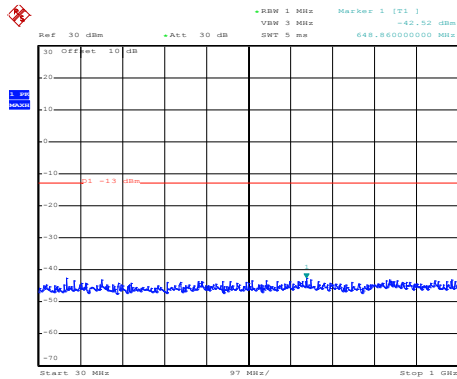

Date: 20.SEP.2019 10:20:29

30MHz~1GHz

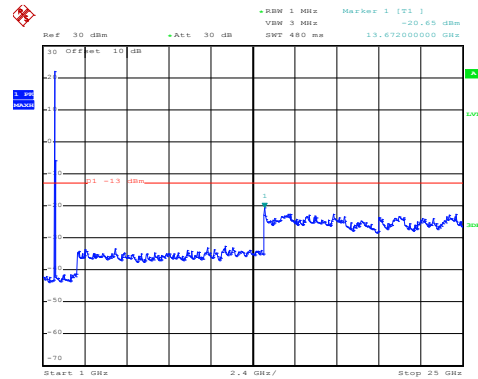

Date: 20.SEP.2019 10:33:16

1GHz~25GHz

## Middle channel

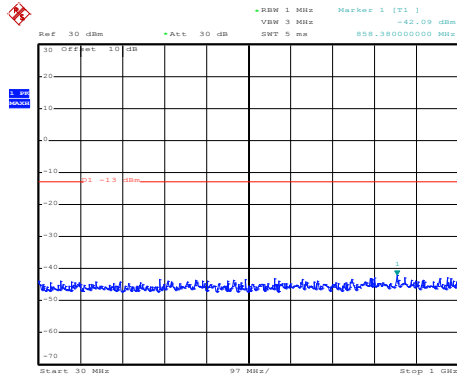

Date: 20.SEP.2019 10:20:48

30MHz~1GHz

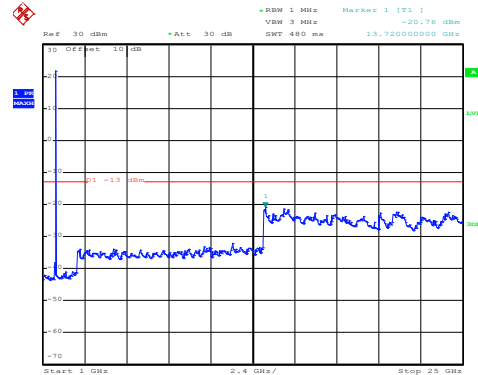

Date: 20.SEP.2019 10:33:36

1GHz~25GHz

## High channel

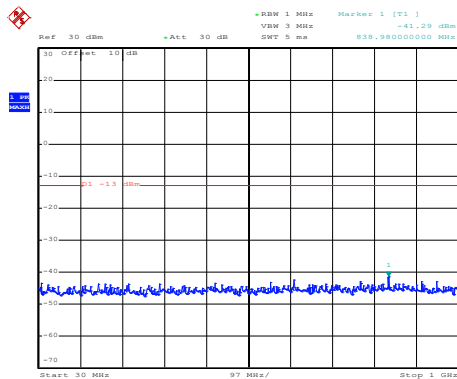

Date: 20.SEP.2019 10:21:29

30MHz~1GHz

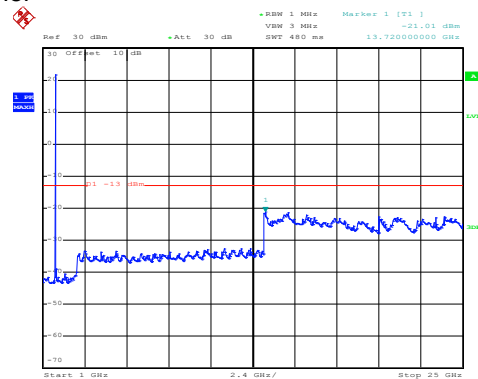

Date: 20.SEP.2019 10:34:49

1GHz~25GHz



## LTE Band 4: QPSK & RB Size 1 BW: 5MHz Lowest channel

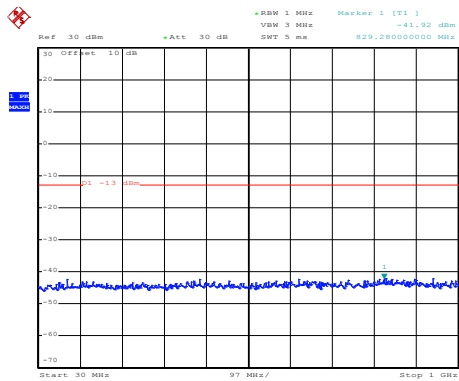

Date: 20.SEP.2019 10:20:10

30MHz~1GHz

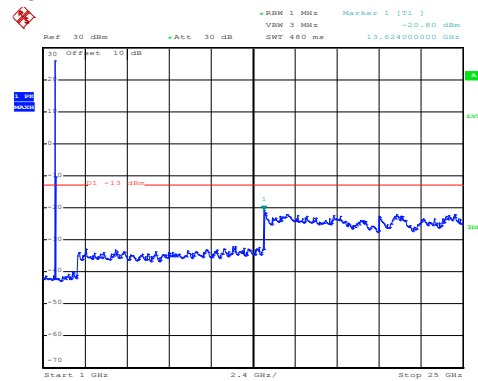

Date: 20.SEP.2019 10:32:52

1GHz~25GHz

## Middle channel

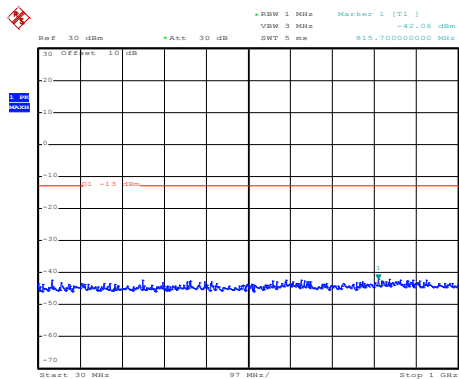

Date: 20.SEP.2019 10:20:57

30MHz~1GHz

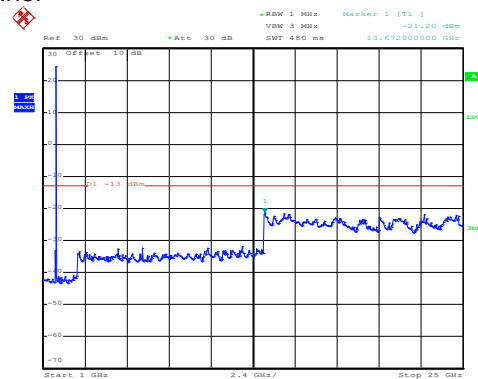

Date: 20.SEP.2019 10:33:47

1GHz~25GHz

## High channel

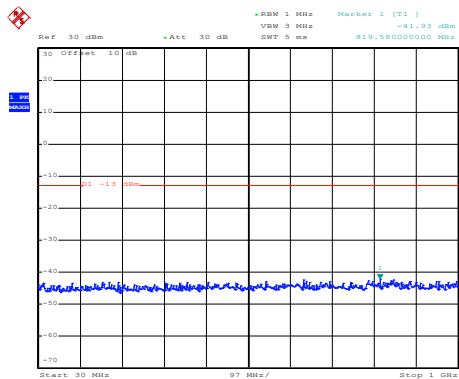

Date: 20.SEP.2019 10:21:11

30MHz~1GHz

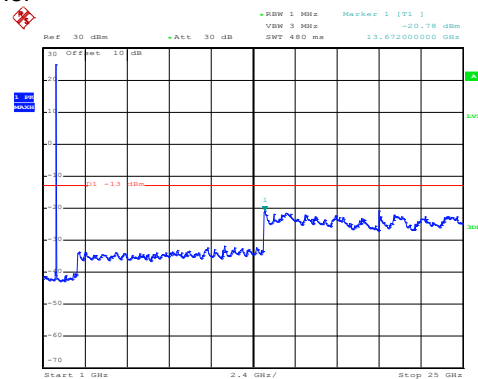

Date: 20.SEP.2019 10:34:18

1GHz~25GHz

LTE Band 4: QPSK & RB Size 25  
 BW: 5MHz  
 Lowest channel

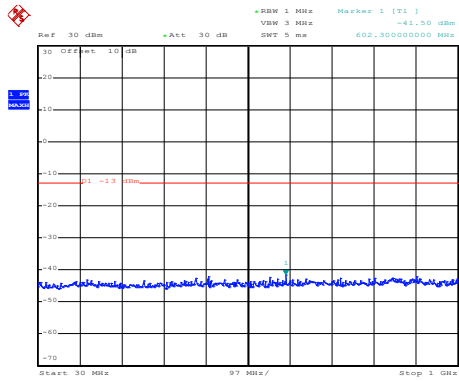

Date: 20.SEP.2019 10:20:25

30MHz~1GHz

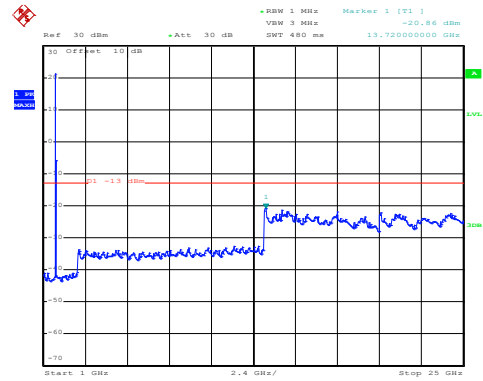

Date: 20.SEP.2019 10:33:09

1GHz~25GHz

Middle channel

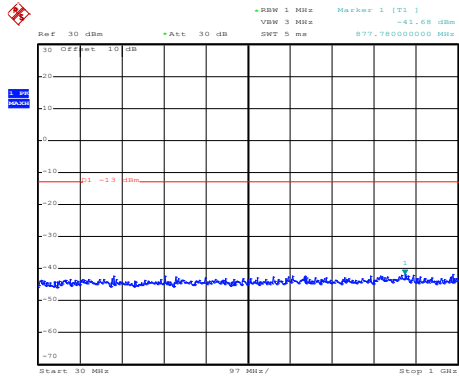

Date: 20.SEP.2019 10:20:44

30MHz~1GHz

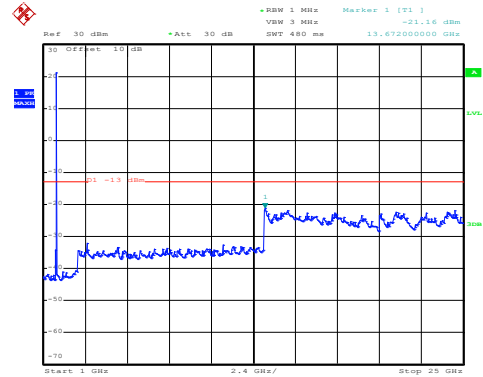

Date: 20.SEP.2019 10:33:28

1GHz~25GHz

High channel

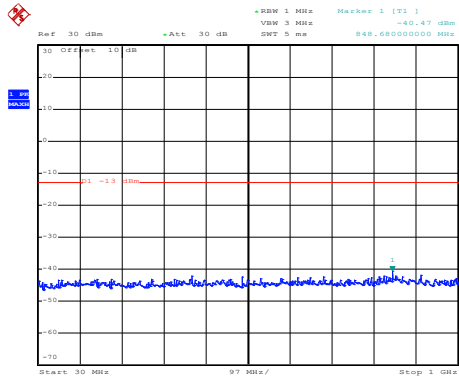

Date: 20.SEP.2019 10:21:24

30MHz~1GHz

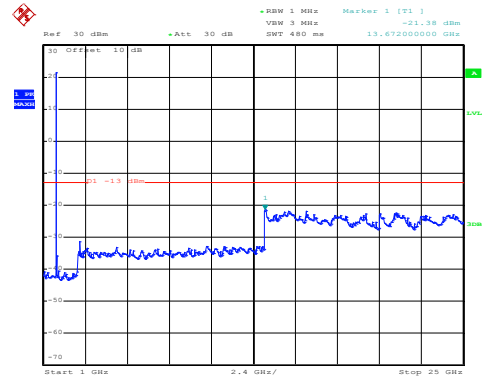

Date: 20.SEP.2019 10:34:39

1GHz~25GHz

## LTE Band 4: 16 QAM & RB Size 1 BW: 10MHz Lowest channel

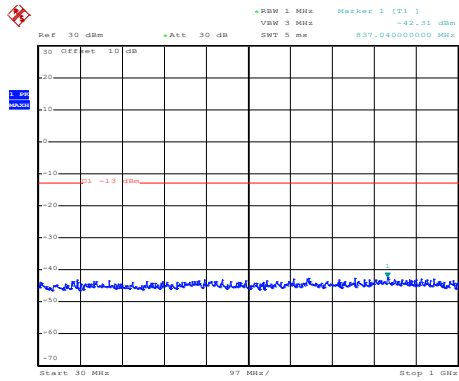

Date: 20.SEP.2019 10:18:40

30MHz~1GHz

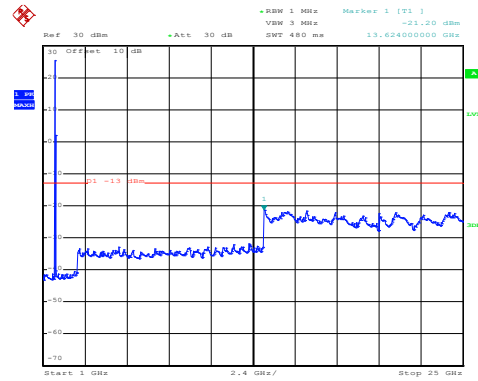

Date: 20.SEP.2019 10:35:34

1GHz~25GHz

## Middle channel

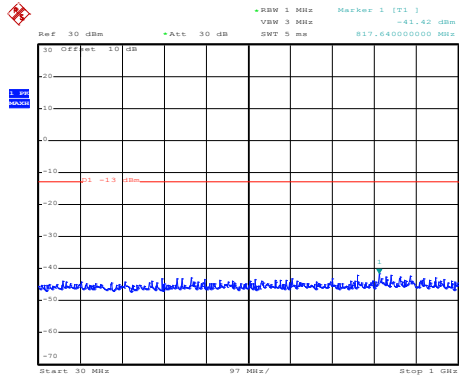

Date: 20.SEP.2019 10:19:21

30MHz~1GHz

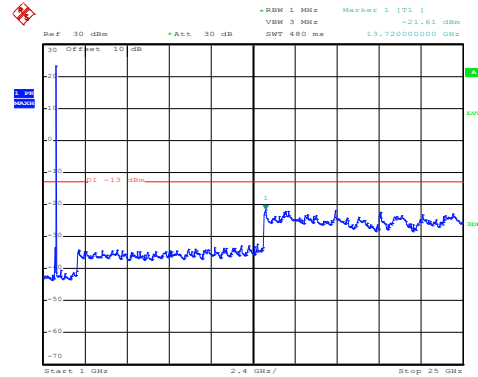

Date: 20.SEP.2019 10:36:47

1GHz~25GHz

## High channel

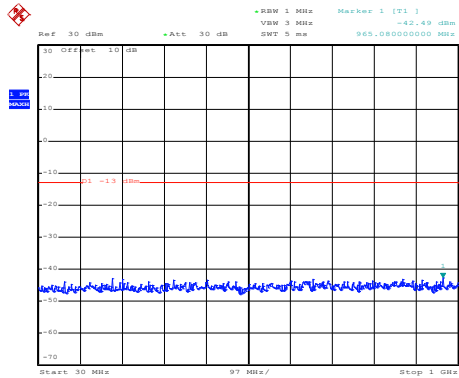

Date: 20.SEP.2019 10:19:36

30MHz~1GHz

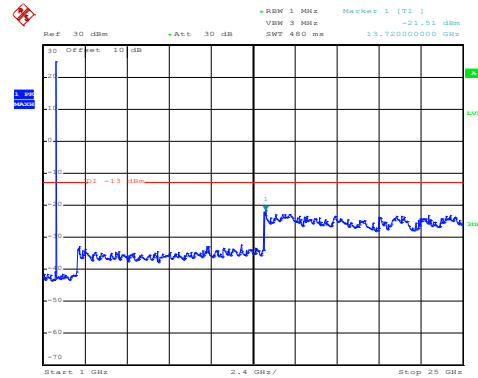

Date: 20.SEP.2019 10:37:12

1GHz~25GHz

LTE Band 4: 16 QAM & RB Size 50  
 BW: 10MHz  
 Lowest channel

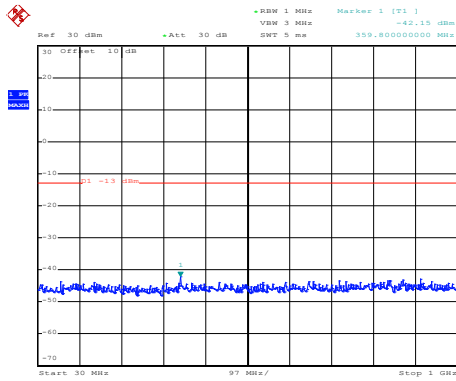

Date: 20.SEP.2019 10:18:53

30MHz~1GHz

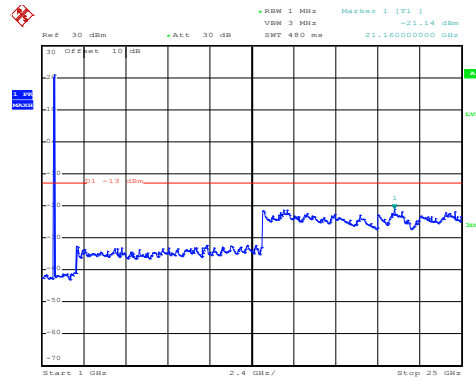

Date: 20.SEP.2019 10:36:03

1GHz~25GHz

Middle channel

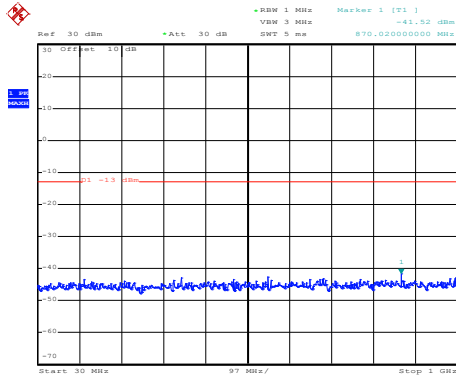

Date: 20.SEP.2019 10:19:08

30MHz~1GHz

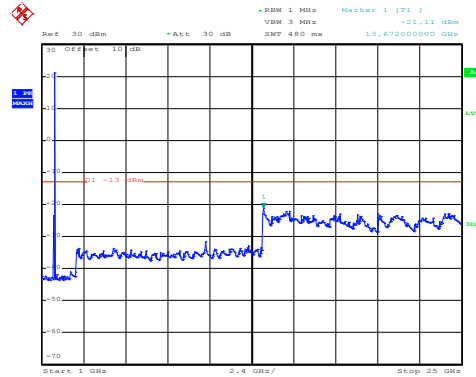

Date: 20.SEP.2019 10:36:31

1GHz~25GHz

High channel

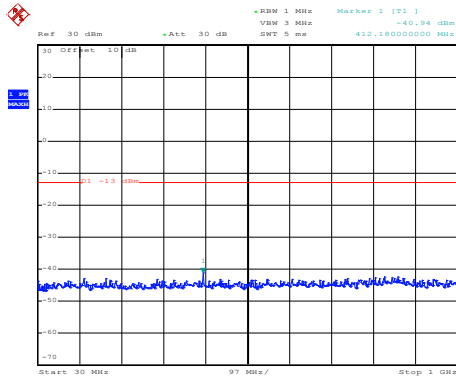

Date: 20.SEP.2019 10:19:50

30MHz~1GHz

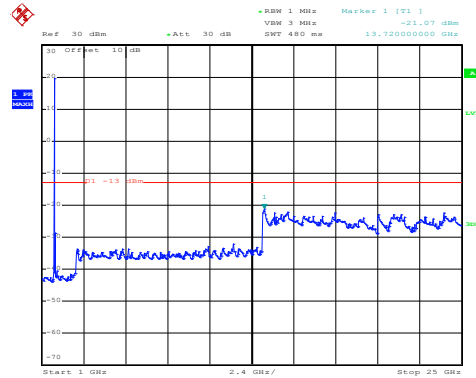

Date: 20.SEP.2019 10:37:34

1GHz~25GHz

## LTE Band 4: QPSK & RB Size 1 BW: 10MHz Lowest channel

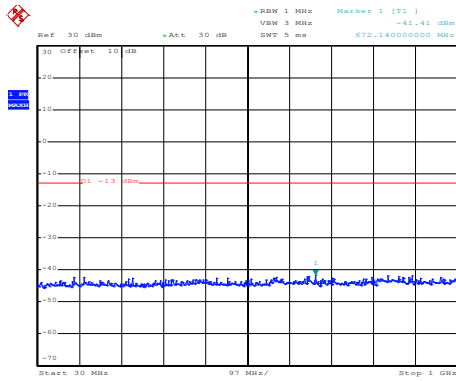

Date: 20.SEP.2019 10:18:35

30MHz~1GHz

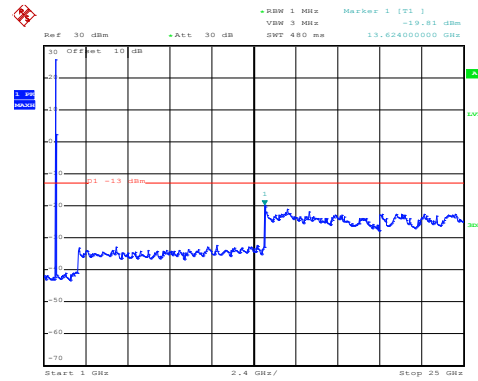

Date: 20.SEP.2019 10:35:19

1GHz~25GHz

## Middle channel

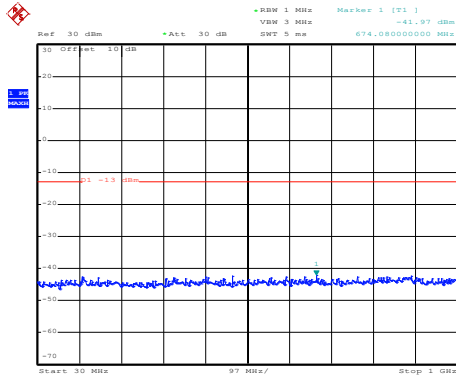

Date: 20.SEP.2019 10:19:16

30MHz~1GHz

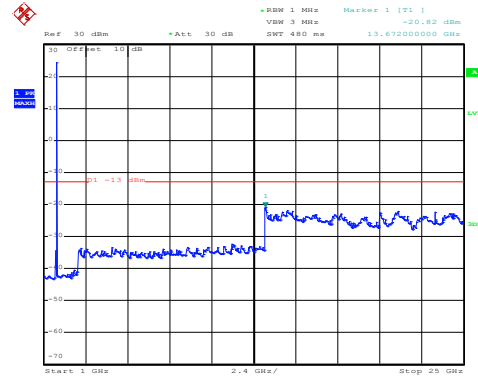

Date: 20.SEP.2019 10:36:41

1GHz~25GHz

## High channel

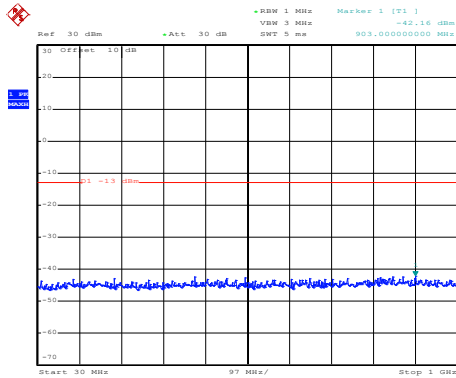

Date: 20.SEP.2019 10:19:32

30MHz~1GHz

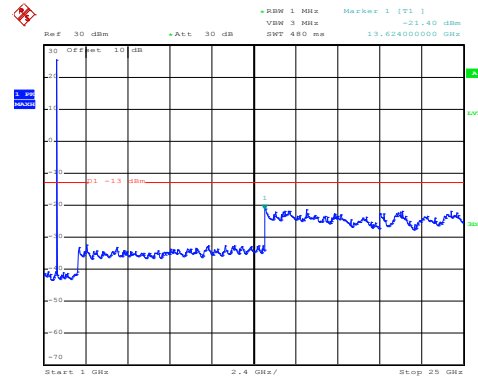

Date: 20.SEP.2019 10:37:06

1GHz~25GHz

## LTE Band 4: QPSK & RB Size 50 BW: 10MHz Lowest channel

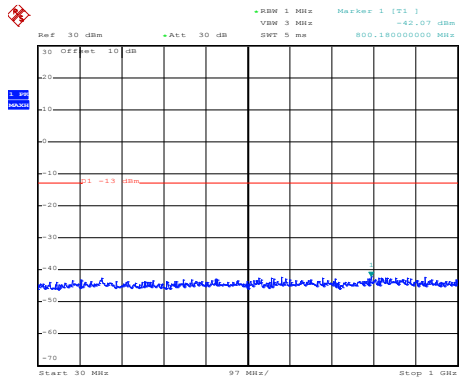

Date: 20.SEP.2019 10:18:48

30MHz~1GHz

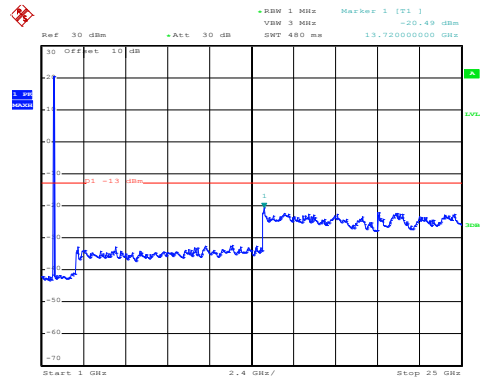

Date: 20.SEP.2019 10:35:44

1GHz~25GHz

## Middle channel

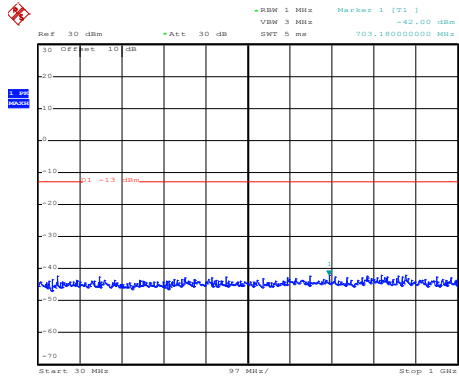

Date: 20.SEP.2019 10:19:02

30MHz~1GHz

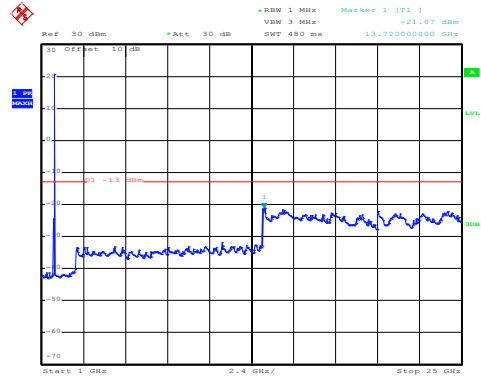

Date: 20.SEP.2019 10:36:24

1GHz~25GHz

## High channel

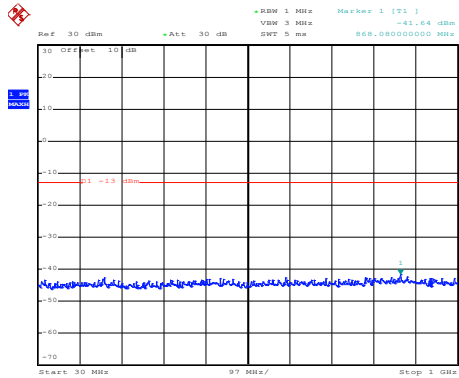

Date: 20.SEP.2019 10:19:44

30MHz~1GHz

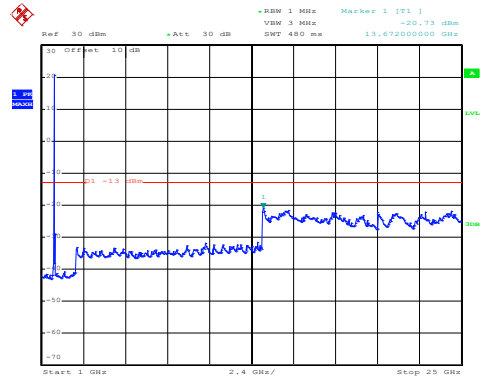

Date: 20.SEP.2019 10:37:27

1GHz~25GHz

## LTE Band 4: 16 QAM & RB Size 1 BW: 15MHz Lowest channel

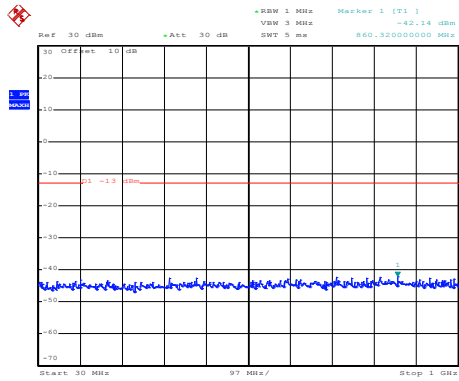

Date: 20.SEP.2019 10:16:59

30MHz~1GHz

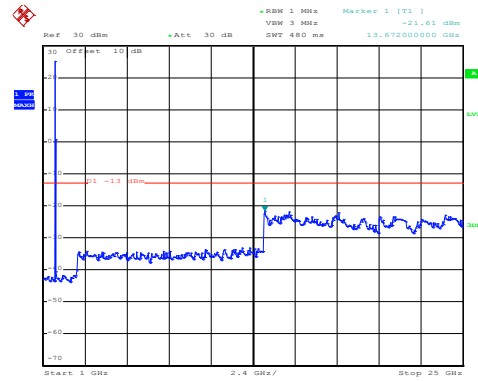

Date: 20.SEP.2019 10:38:10

1GHz~25GHz

## Middle channel

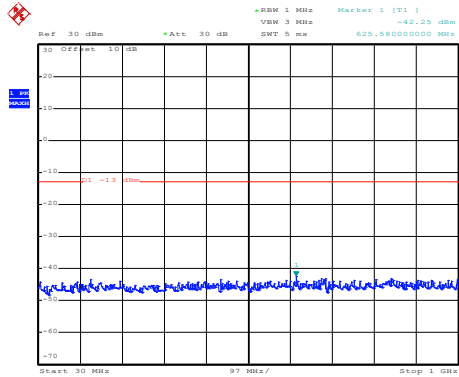

Date: 20.SEP.2019 10:17:41

30MHz~1GHz

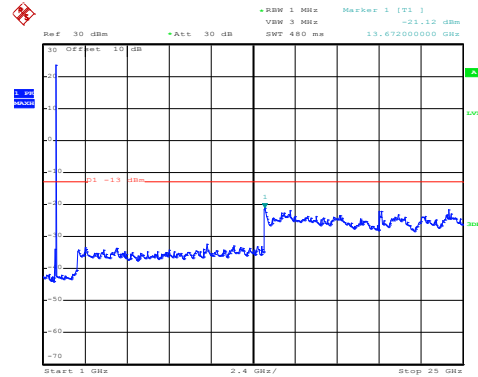

Date: 20.SEP.2019 10:39:22

1GHz~25GHz

## High channel

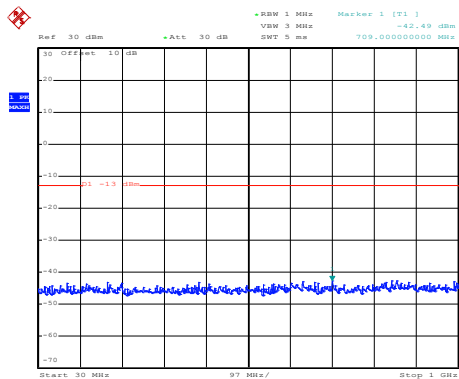

Date: 20.SEP.2019 10:17:58

30MHz~1GHz

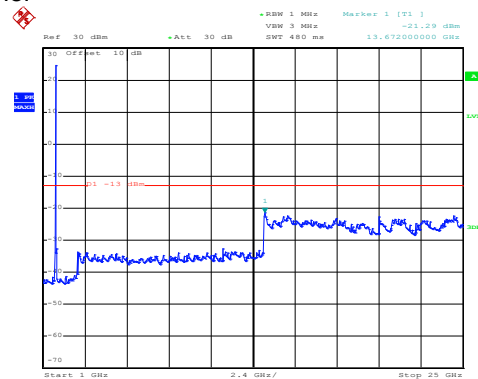

Date: 20.SEP.2019 10:39:45

1GHz~25GHz

LTE Band 4: 16 QAM & RB Size 75  
 BW: 15MHz  
 Lowest channel

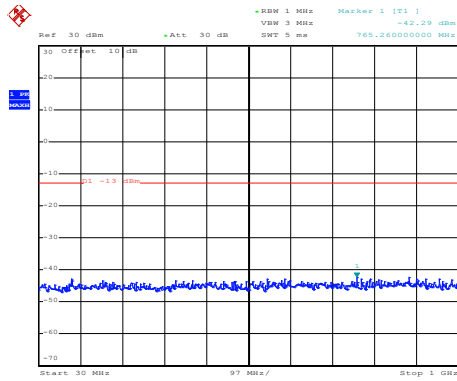

Date: 20.SEP.2019 10:17:14

30MHz~1GHz

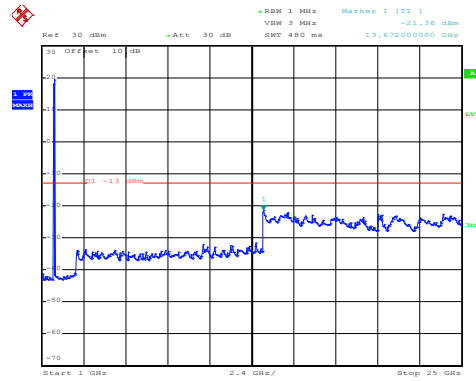

Date: 20.SEP.2019 10:38:37

1GHz~25GHz

Middle channel

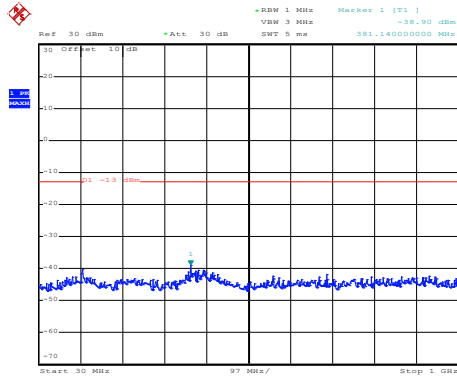

Date: 20.SEP.2019 10:17:27

30MHz~1GHz

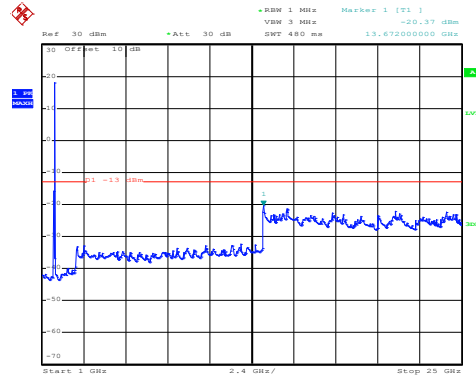

Date: 20.SEP.2019 10:39:01

1GHz~25GHz

High channel

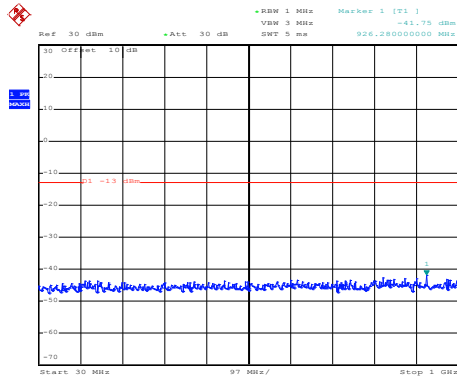

Date: 20.SEP.2019 10:18:10

30MHz~1GHz

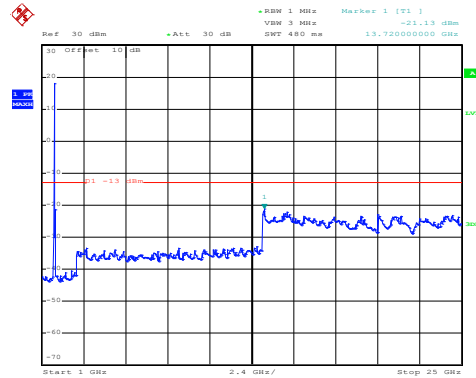

Date: 20.SEP.2019 10:40:02

1GHz~25GHz



## LTE Band 4: QPSK & RB Size 1 BW: 15MHz Lowest channel

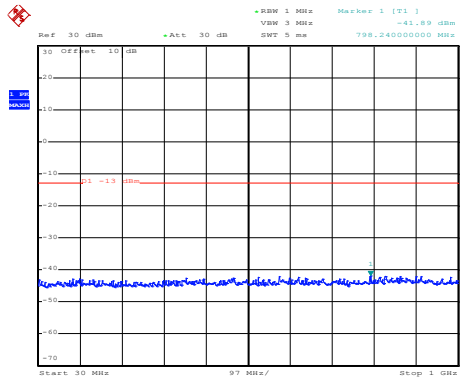

Date: 20.SEP.2019 10:16:53

30MHz~1GHz

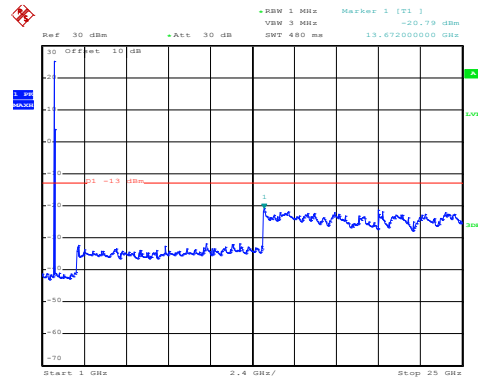

Date: 20.SEP.2019 10:38:04

1GHz~25GHz

## Middle channel

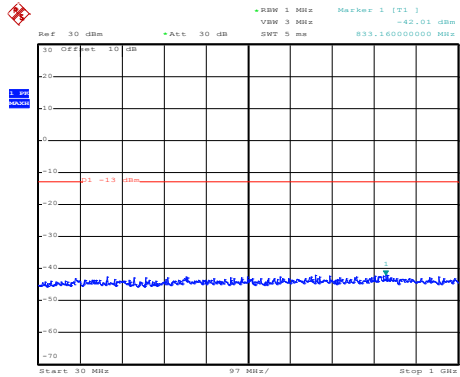

Date: 20.SEP.2019 10:17:37

30MHz~1GHz

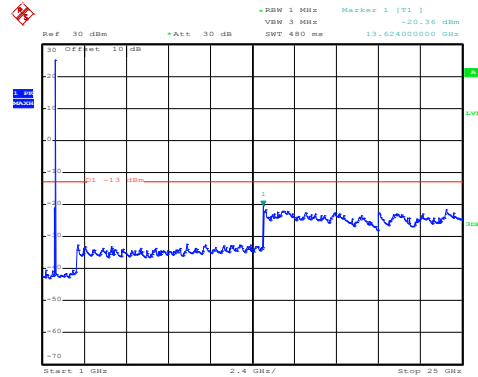

Date: 20.SEP.2019 10:39:16

1GHz~25GHz

## High channel

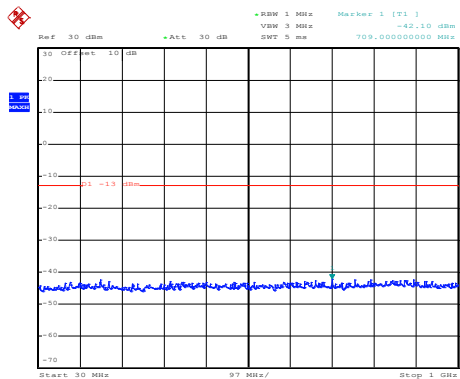

Date: 20.SEP.2019 10:17:54

30MHz~1GHz

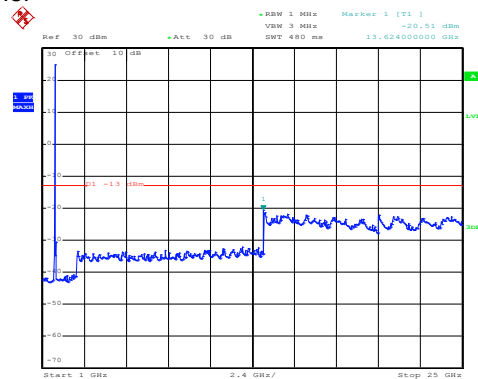

Date: 20.SEP.2019 10:39:39

1GHz~25GHz

LTE Band 4: QPSK & RB Size 75  
 BW: 15MHz  
 Lowest channel

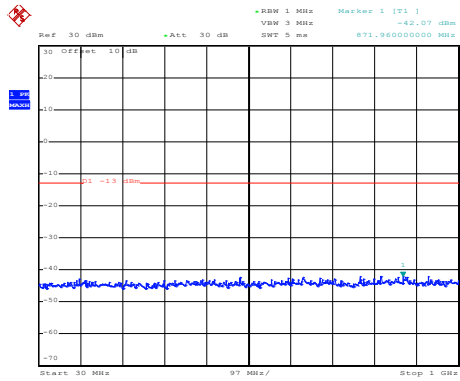

Date: 20.SEP.2019 10:17:07

30MHz~1GHz

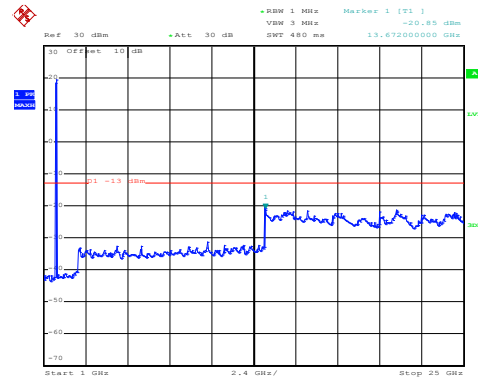

Date: 20.SEP.2019 10:38:28

1GHz~25GHz

Middle channel

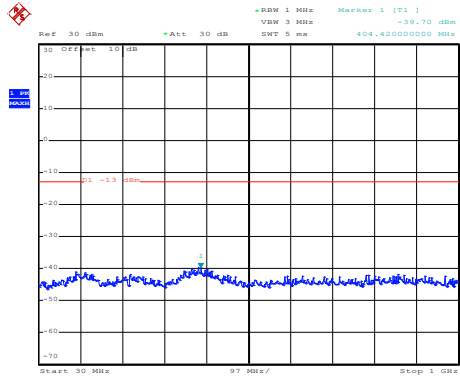

Date: 20.SEP.2019 10:17:22

30MHz~1GHz

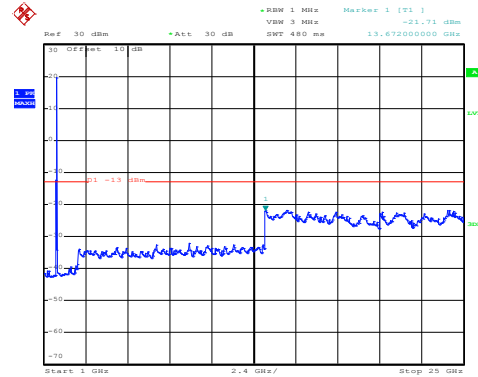

Date: 20.SEP.2019 10:38:54

1GHz~25GHz

High channel

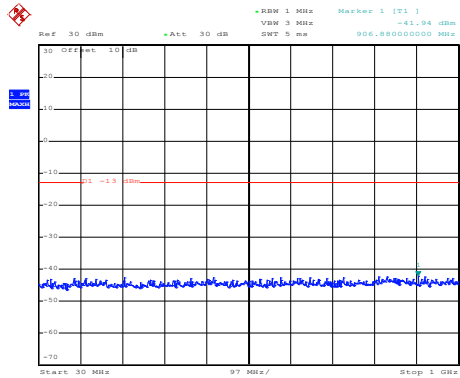

Date: 20.SEP.2019 10:18:06

30MHz~1GHz

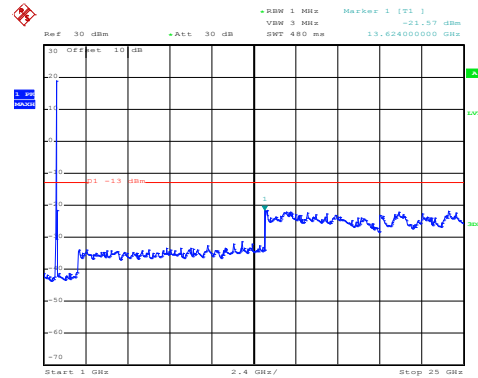

Date: 20.SEP.2019 10:39:55

1GHz~25GHz

## LTE Band 4: 16 QAM & RB Size 1 BW: 20MHz Lowest channel

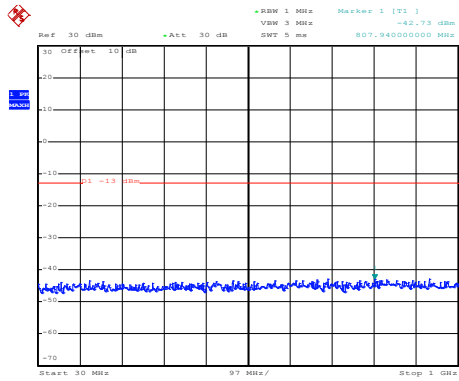

Date: 20.SEP.2019 10:15:17

30MHz~1GHz

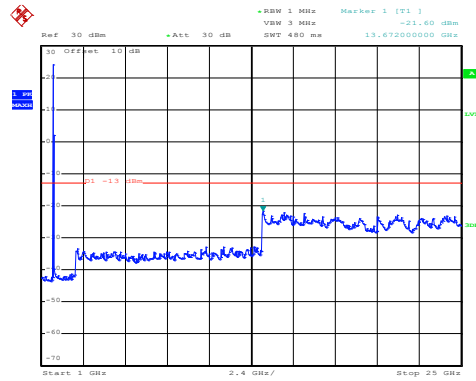

Date: 20.SEP.2019 10:40:38

1GHz~25GHz

## Middle channel

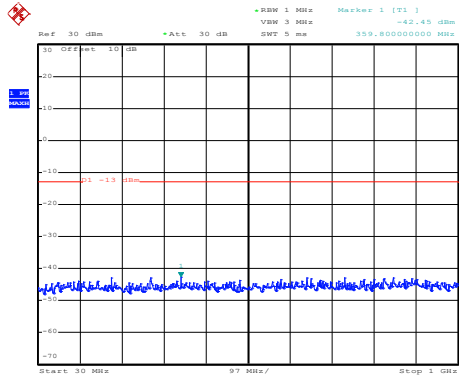

Date: 20.SEP.2019 10:15:59

30MHz~1GHz

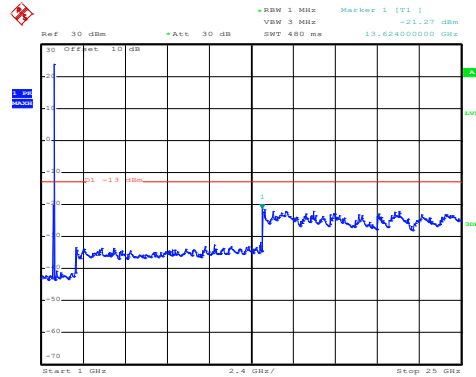

Date: 20.SEP.2019 10:41:56

1GHz~25GHz

## High channel

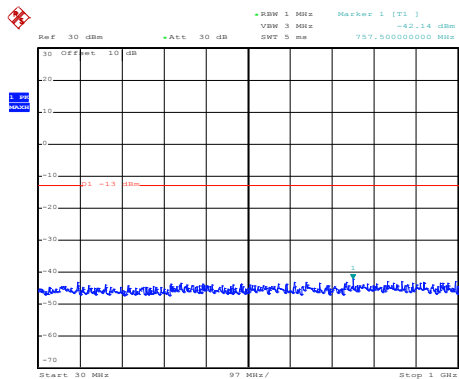

Date: 20.SEP.2019 10:16:13

30MHz~1GHz

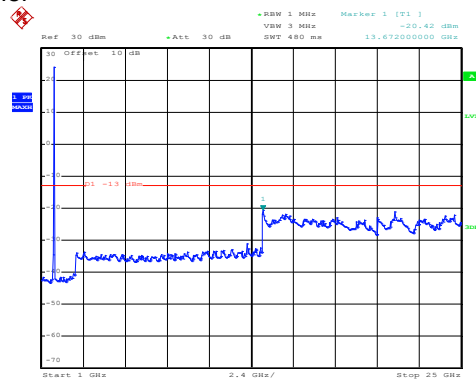

Date: 20.SEP.2019 10:42:24

1GHz~25GHz

## LTE Band 4: 16 QAM & RB Size 100 BW: 20MHz Lowest channel

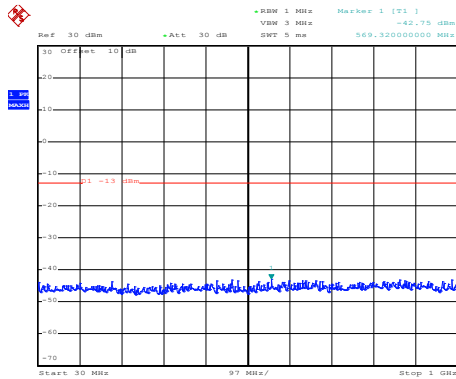

Date: 20.SEP.2019 10:15:32

30MHz~1GHz

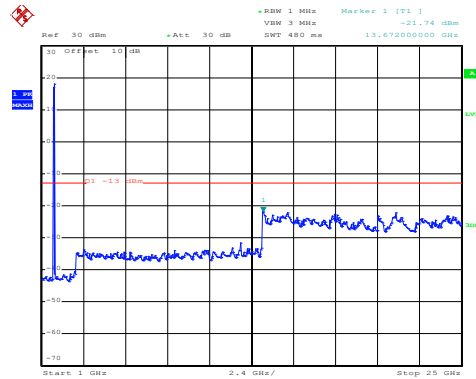

Date: 20.SEP.2019 10:41:02

1GHz~25GHz

## Middle channel

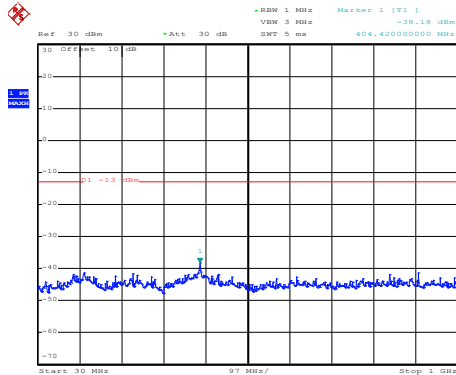

Date: 20.SEP.2019 10:15:47

30MHz~1GHz

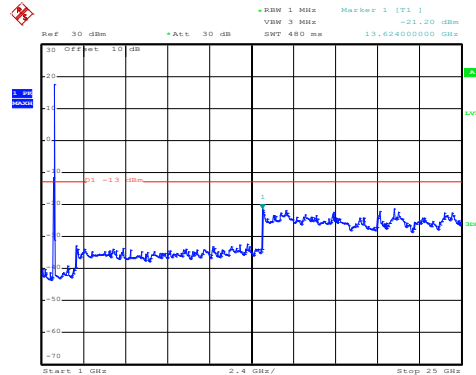

Date: 20.SEP.2019 10:41:23

1GHz~25GHz

## High channel

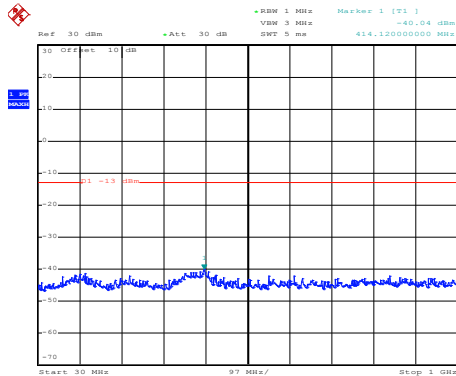

Date: 20.SEP.2019 10:16:27

30MHz~1GHz

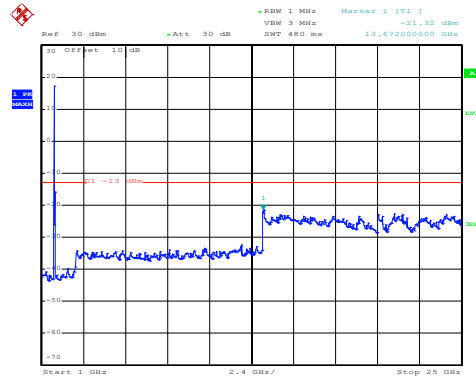

Date: 20.SEP.2019 10:42:41

1GHz~25GHz

## LTE Band 4: QPSK & RB Size 1 BW: 20MHz Lowest channel

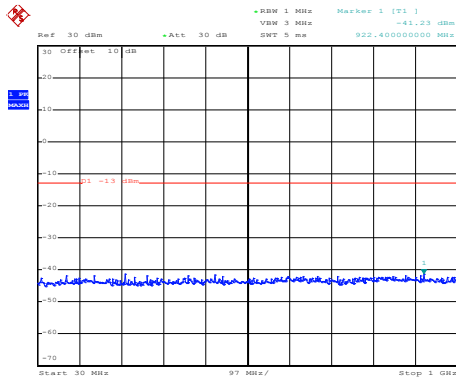

Date: 20.SEP.2019 10:15:10

30MHz~1GHz

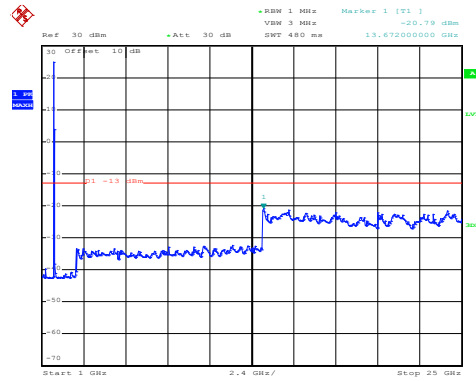

Date: 20.SEP.2019 10:40:31

1GHz~25GHz

## Middle channel

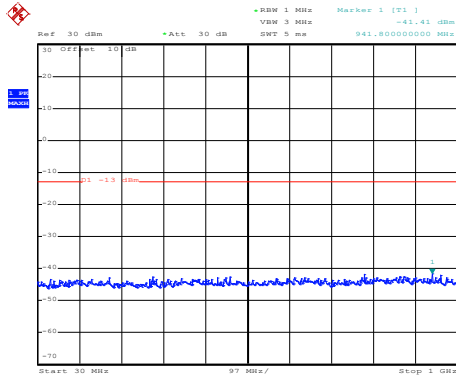

Date: 20.SEP.2019 10:15:55

30MHz~1GHz

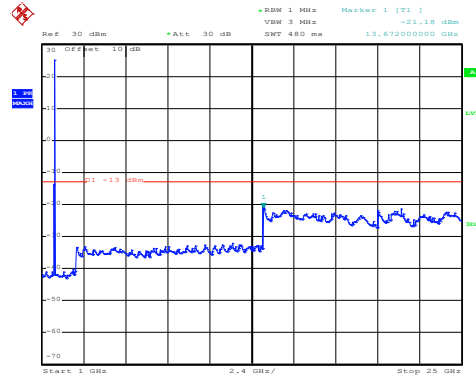

Date: 20.SEP.2019 10:41:46

1GHz~25GHz

## High channel

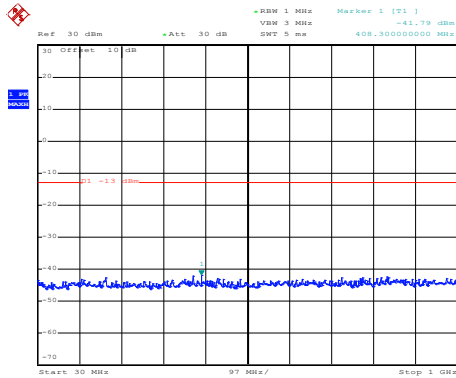

Date: 20.SEP.2019 10:16:09

30MHz~1GHz

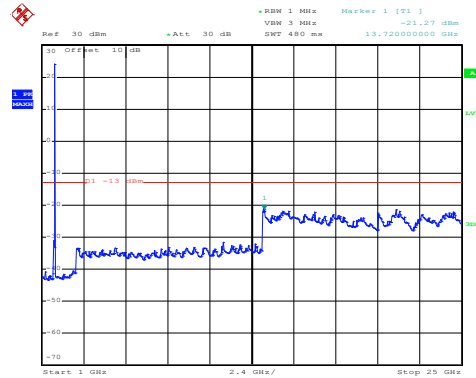

Date: 20.SEP.2019 10:42:14

1GHz~25GHz

LTE Band 4: QPSK & RB Size 100  
 BW: 20MHz  
 Lowest channel

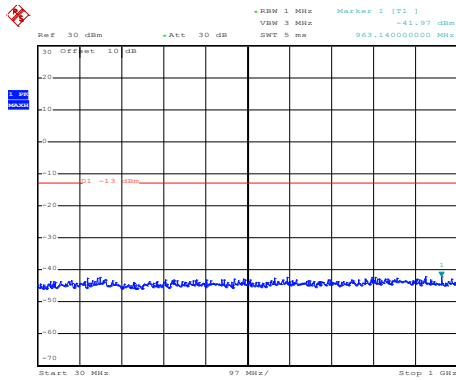

Date: 20.SEP.2019 10:15:26

30MHz~1GHz

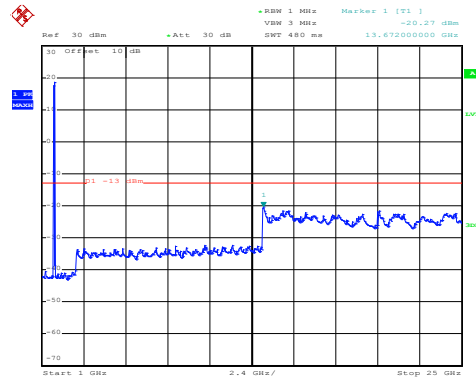

Date: 20.SEP.2019 10:40:55

1GHz~25GHz

Middle channel

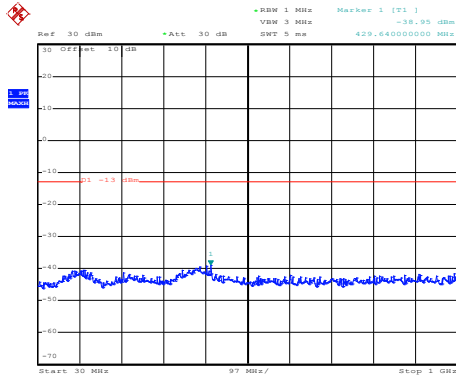

Date: 20.SEP.2019 10:15:43

30MHz~1GHz

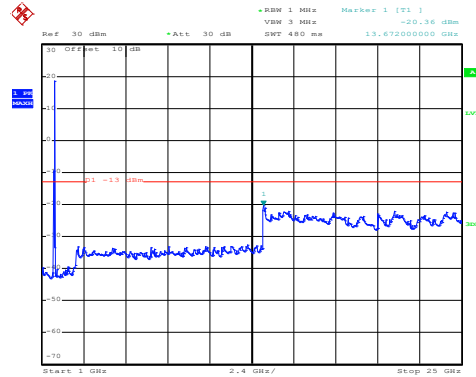

Date: 20.SEP.2019 10:41:16

1GHz~25GHz

High channel

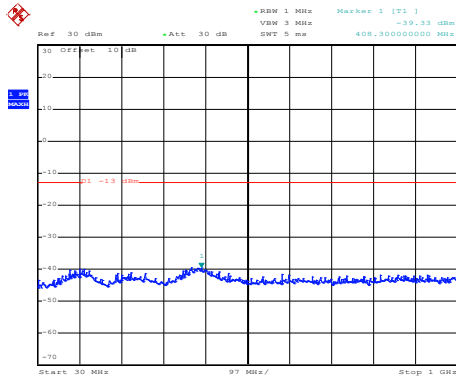

Date: 20.SEP.2019 10:16:22

30MHz~1GHz

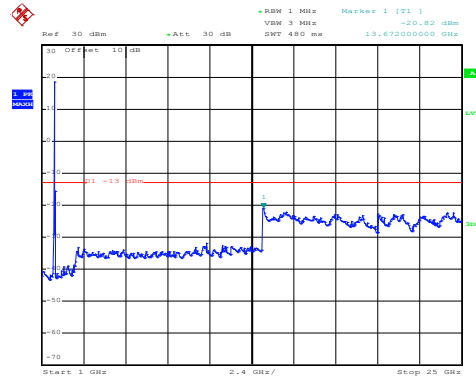

Date: 20.SEP.2019 10:42:34

1GHz~25GHz

LTE Band 5 part:

LTE Band 5: 16 QAM & RB Size 1  
 BW: 1.4MHz  
 Lowest channel

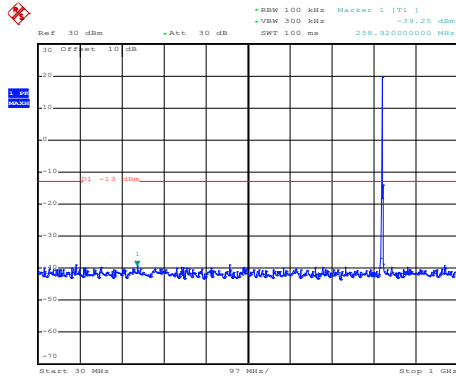

Date: 20.SEP.2019 11:08:15

30MHz~1GHz

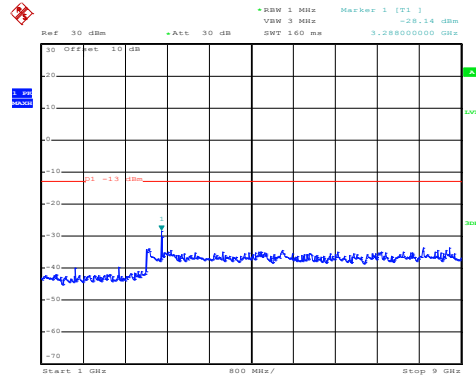

Date: 20.SEP.2019 10:43:46

1GHz~9GHz

Middle channel

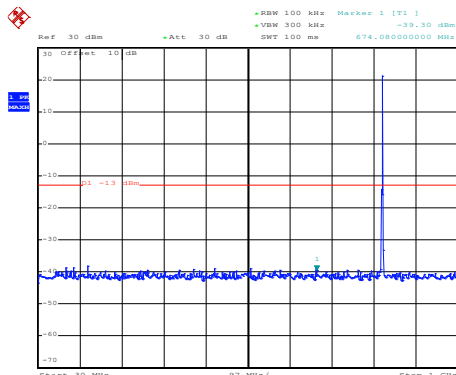

Date: 20.SEP.2019 11:09:19

30MHz~1GHz

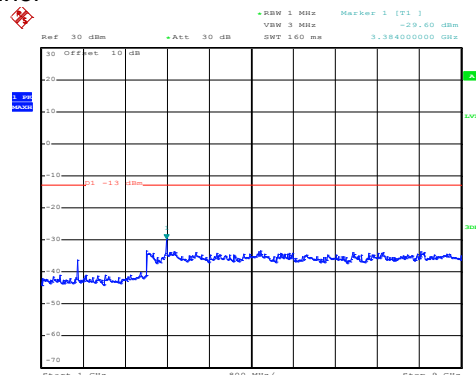

Date: 20.SEP.2019 10:51:01

1GHz~9GHz

High channel

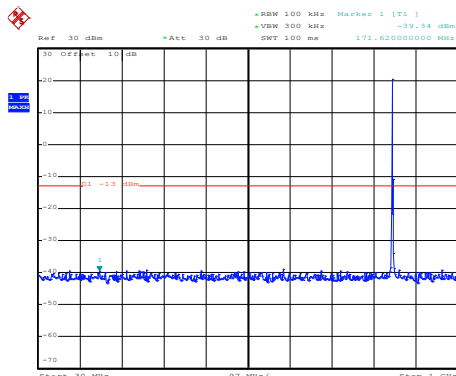

Date: 20.SEP.2019 11:09:42

30MHz~1GHz

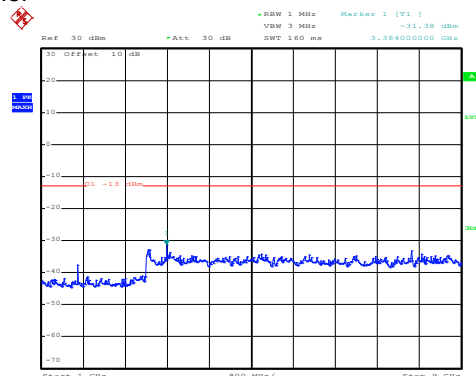

Date: 20.SEP.2019 10:51:19

1GHz~9GHz

## LTE Band 5: 16 QAM & RB Size 6 BW: 1.4MHz Lowest channel

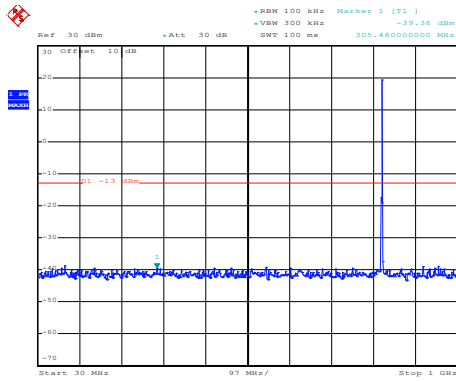

Date: 20.SEP.2019 11:08:36

30MHz~1GHz

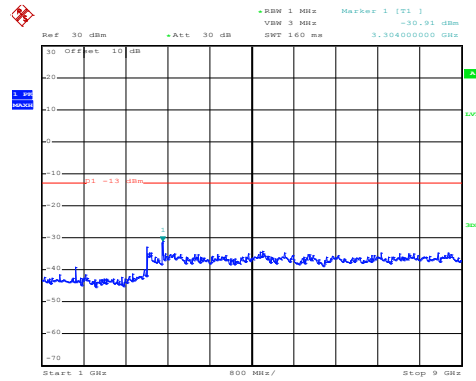

Date: 20.SEP.2019 10:44:00

1GHz~9GHz

## Middle channel

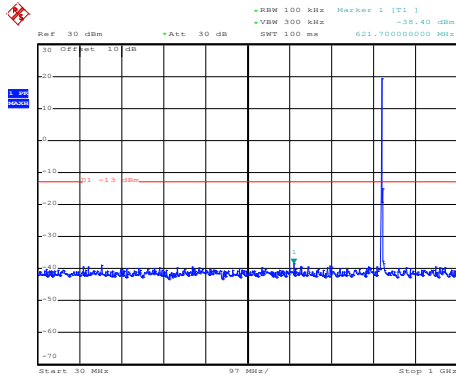

Date: 20.SEP.2019 11:08:58

30MHz~1GHz

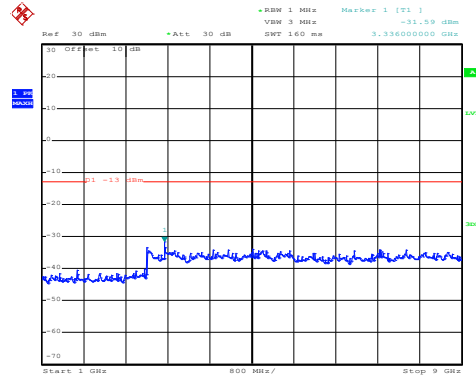

Date: 20.SEP.2019 10:44:16

1GHz~9GHz

## High channel

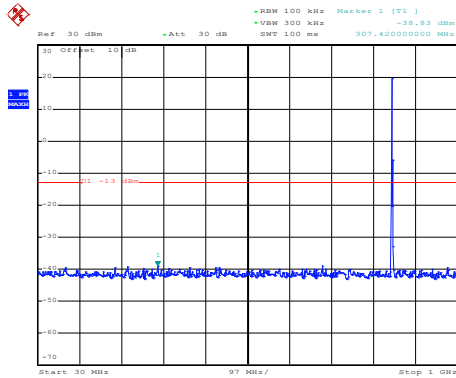

Date: 20.SEP.2019 11:10:03

30MHz~1GHz

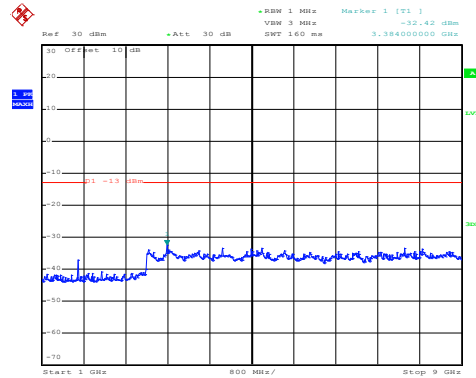

Date: 20.SEP.2019 10:51:35

1GHz~9GHz