



---

# SAR Test Report

---

Report No.: AGC01321140708FH01

**FCC ID** : 2ABGBE50

**APPLICATION PURPOSE** : Original Equipment

**PRODUCT DESIGNATION** : Mobile Phone

**BRAND NAME** : MAGICON,QUE

**MODEL NAME** : HERO E50,QUE 5.0

**CLIENT** : Complex International Limited

**DATE OF ISSUE** : July 28,2014

**STANDARD(S)** : IEEE Std. 1528:2003  
47CFR § 2.1093  
IEEE/ANSI C95.1

**REPORT VERSION** : V1.0

Attestation of Global Compliance(Shenzhen) Co., Ltd.



**CAUTION:**

This report shall not be reproduced except in full without the written permission of the test laboratory and shall not be quoted out of context.

### Report Revise Record

Report Version	Revise Time	Issued Date	Valid Version	Notes
V1.0	/	July 28,2014	Valid	Original Report

The test plans were performed in accordance with IEEE Std. 1528:2003; 47CFR § 2.1093; IEEE/ANSI C95.1 and the following specific FCC Test Procedures:

- KDB 447498 D01 General RF Exposure Guidance v05r02
- KDB 648474 D04 SAR Handsets Multi Xmitter and Ant v01
- KDB 865664 D01 SAR measurement 100 MHz to 6 GHz v01r03
- KDB 941225 D01 SAR test for 3G devices v02
- KDB 941225 D02 Guidance for 3GPP R6 and R7 HSPA v02r02
- KDB 941225 D03 SAR Test Reduction GSM GPRS EDGE v01
- KDB 941225 D06 Hot Spot SAR v01
- KDB 248227 D01 SAR meas for 802 11 a b g v01r02

## Test Report Certification

Applicant Name	Complex International Limited
Applicant Address	Unit 902-904, 9 <sup>th</sup> Floor, Tower B, Hung Hom Commercial Centre, 37, Ma Tau Wai Road, Hung Hum, Kowloon, HongKong.
Manufacturer Name	Complex International Limited
Manufacturer Address	Unit 902-904, 9th Floor, Tower B, Hung Hom Commercial Centre, 37, Ma Tau Wai Road, Hung Hum, Kowloon, HongKong.
Product Designation	Mobile Phone
Brand Name	MAGICON,QUE
Model Name	HERO E50,QUE 5.0
Different Description	All the same, except for the brand name and model name. HERO E50 is corresponding to MAGICON, QUE5.0 is corresponding to QUE. The test model is QUE 5.0.
EUT Voltage	DC3.7V by battery
Applicable Standard	IEEE Std. 1528:2003 47CFR § 2.1093 IEEE/ANSI C95.1
Test Date	July 24,2014
Performed Location	Attestation of Global Compliance(Shenzhen) Co., Ltd. 2 F, Building 2, No.1-No.4, Chaxi Sanwei Technical Industrial Park, Gushu, Xixiang Street, Bao'an District, Shenzhen, China
Report Template	AGCRT-US-3G3/SAR (2014-04-01)

Tested By

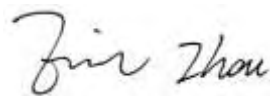

Eric Zhou                      July 28,2014

Checked By

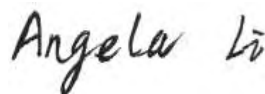

Angela Li                      July 28,2014

Authorized By



Solger Zhang                      July 28,2014

## TABLE OF CONTENTS

<b>1. SUMMARY OF MAXIMUM SAR VALUE .....</b>	<b>5</b>
<b>2. GENERAL INFORMATION.....</b>	<b>6</b>
2.1. EUT DESCRIPTION.....	6
2.2. TEST PROCEDURE .....	8
2.3. TEST ENVIRONMENT .....	8
2.4. TEST CONFIGURATION AND SETTING .....	9
<b>3. SAR MEASUREMENT SYSTEM.....</b>	<b>10</b>
3.1. SPECIFIC ABSORPTION RATE (SAR).....	10
3.2. SAR MEASUREMENT PROCEDURE .....	11
3.3. COMOSAR SYSTEM DESCRIPTION .....	12
3.4. COMOSAR E-FIELD PROBE .....	14
3.5. ISOTROPIC E-FIELD PROBE SPECIFICATION .....	14
3.6. ROBOT.....	14
3.7. VIDEO POSITIONING SYSTEM .....	15
3.8. DEVICE HOLDER .....	15
3.9. SAM TWIN PHANTOM.....	16
<b>4. TISSUE SIMULATING LIQUID .....</b>	<b>17</b>
4.1. THE COMPOSITION OF THE TISSUE SIMULATING LIQUID.....	17
4.2. TISSUE CALIBRATION RESULT .....	18
4.3. TISSUE DIELECTRIC PARAMETERS FOR HEAD AND BODY PHANTOMS .....	19
<b>5. SAR MEASUREMENT PROCEDURE.....</b>	<b>20</b>
5.1. SAR SYSTEM VALIDATION PROCEDURES.....	20
5.2. SAR SYSTEM VALIDATION .....	21
<b>6. EUT TEST POSITION.....</b>	<b>23</b>
6.1. DEFINE TWO IMAGINARY LINES ON THE HANDSET.....	23
6.2. CHEEK POSITION .....	24
6.3. TITLE POSITION .....	24
6.4. BODY WORN POSITION.....	25
<b>7. SAR EXPOSURE LIMITS .....</b>	<b>26</b>
<b>8. TEST EQUIPMENT LIST .....</b>	<b>27</b>
<b>9. MEASUREMENT UNCERTAINTY .....</b>	<b>28</b>
<b>10. CONDUCTED POWER MEASUREMENT.....</b>	<b>29</b>
<b>11. TEST RESULTS .....</b>	<b>36</b>
11.1. SAR TEST RESULTS SUMMARY .....	36
<b>APPENDIX A. SAR SYSTEM VALIDATION DATA .....</b>	<b>45</b>
<b>APPENDIX B. SAR MEASUREMENT DATA.....</b>	<b>61</b>
<b>APPENDIX C. TEST SETUP PHOTOGRAPHS &amp;EUT PHOTOGRAPHS.....</b>	<b>153</b>
<b>APPENDIX D. PROBE CALIBRATION DATA .....</b>	<b>163</b>
<b>APPENDIX E. DIPOLE CALIBRATION DATA .....</b>	<b>173</b>

## 1. SUMMARY OF MAXIMUM SAR VALUE

The maximum results of Specific Absorption Rate (SAR) found during testing for EUT are as follows:

### Highest Report standalone SAR Summary

Exposure Position	Frequency Band	Highest Tested 1g-SAR(W/Kg)	Highest Scaled Maximum SAR(W/Kg)
Head	GSM 835	0.384	0.500
	PCS 1900	0.323	0.413
	WCDMA Band II	0.874	0.882
	WCDMA Band V	0.733	0.754
	WCDMA Band IV	0.667	0.711
Body- worn	GSM 835	0.708	0.923
	PCS 1900	0.765	0.979
	WCDMA Band II	1.104	1.114
	WCDMA Band V	1.178	1.211
	WCDMA Band IV	1.175	1.236

Exposure Position	Test Mode	Highest Tested 1g-SAR(W/Kg)	Highest Scaled Maximum SAR(W/Kg)
Body	HOTSPOT	0.175	0.184

### Highest Simultaneous transmission SAR Summary

Exposure Position	Frequency Band	Highest Simultaneous SAR(W/Kg)
Head	GSM 835+WLAN	0.914
	PCS 1900+WLAN	0.827
	WCDMA Band II+WLAN	1.296
	WCDMA Band V+WLAN	1.168
	WCDMA Band IV+WLAN	1.125
Body-worn	GSM 835+WLAN	1.130
	PCS 1900+WLAN	1.186
	WCDMA Band II+WLAN	1.321
	WCDMA Band V+WLAN	1.418
	WCDMA Band IV+WLAN	1.308

This device is compliance with Specific Absorption Rate (SAR) for general population/uncontrolled exposure limits (1.6W/Kg) specified in FCC 47 CFR part 2 (2.1093) and ANSI/IEEE C95.1, and had been tested in accordance with measurement methods and procedures specified in IEEE 1528-2003 and the relevant KDB files like KDB 941225 D01 , KDB 941225 D03 ,KDB 865664 D02....etc.

## 2. GENERAL INFORMATION

### 2.1. EUT Description

General Information	
Product Designation	Mobile Phone
Test Model	QUE 5.0
Hardware Version	K22_MB
Software Version	N/A
Device Category	Portable
RF Exposure Environment	Uncontrolled
Antenna Type	Internal
GSM and GPRS&EGPRS	
Support Band	<input checked="" type="checkbox"/> GSM 850 <input checked="" type="checkbox"/> PCS 1900 (U.S. Bands) <input checked="" type="checkbox"/> GSM 900 <input checked="" type="checkbox"/> DCS 1800 (Non-U.S. Bands)
GPRS &EGPRS Type	Class B
GPRS &EGPRS Class	Class12(1Tx+4Rx, 2Tx+3Rx, 3Tx+2Rx, 4Tx+1Rx)
TX Frequency Range	GSM 850 : 824.2~848.8MHz; PCS 1900: 1850.2~1909.8MHz;
RX Frequency Range	GSM 850 : 869~894MHz PCS 1900: 1930~1990MHz
Release Version	R99
Type of modulation	GMSK for GSM/GPRS, GMSK&8-PSK for EGPRS
Antenna Gain	-1.0dBi(GSM 850), -0.8dBi (PCS 1900)
Max. Average Power (Max. Peak Power)	GSM850: 31.88dBm(32.47dBm- Peak Power) PCS1900: 28.97dBm(29.61dBm-Peak Power)
Bluetooth	
Bluetooth Version	<input type="checkbox"/> V2.0 <input type="checkbox"/> V2.1 <input type="checkbox"/> V2.1+EDR <input checked="" type="checkbox"/> V3.0 <input type="checkbox"/> V3.0+HS <input checked="" type="checkbox"/> V4.0
Operation Frequency	2402~2480MHz
Type of modulation	<input checked="" type="checkbox"/> GFSK <input checked="" type="checkbox"/> II/4-DQPSK <input checked="" type="checkbox"/> 8-DPSK
Avg. Burst Power	4.3dBm
Antenna Gain	0.8dBi

**EUT Description( Continue)**

<b>WCDMA</b>	
Support Band	U.S. Bands: <input checked="" type="checkbox"/> UMTS FDD Band II <input checked="" type="checkbox"/> UMTS FDD Band V <input checked="" type="checkbox"/> UMTS FDD Band IV Non-U.S. Bands: <input checked="" type="checkbox"/> UMTS FDD Band I <input type="checkbox"/> UMTS FDD Band III <input type="checkbox"/> UMTS FDD Band VIII
HS Type	HSPA(HSUPA/HSDPA)
TX Frequency Range	WCDMA FDD Band II: 1852.4 -1907.6MHz WCDMA FDD Band V: 826.4-846.6MHz WCDMA FDD Band IV: 1710-1755MHz
RX Frequency Range	WCDMA FDD Band II: 1930-1990MHz WCDMA FDD Band V: 869-894MHz WCDMA FDD Band IV: 2110.4-2155MHz
Release Version	Rel-6
Type of modulation	QPSK
Antenna Gain	-1.0dBi(WCDMA 850), -0.8dBi (WCDMA 1700/1900)
Max. Average Power (Max. Peak Power)	Band II: 22.97dBm (23.48dBm- Peak Power) Band V: 22.91dBm (23.45dBm- Peak Power) Band IV: 22.78dBm (23.24dBm- Peak Power)
<b>WIFI</b>	
WIFI Specification	<input type="checkbox"/> 802.11a <input checked="" type="checkbox"/> 802.11b <input checked="" type="checkbox"/> 802.11g <input checked="" type="checkbox"/> 802.11n(20) <input checked="" type="checkbox"/> 802.11n(40)
Operation Frequency	2412~2472MHz
Avg. Burst Power	11b:9.84dBm,11g:7.24dBm,11n(20):7.16dBm,11n(40):4.48dBm
Antenna Gain	0.8dBi
<b>Accessories</b>	
Battery	Brand name: MAGICON,QUE Model No. : HERO E50,QUE 5.0 Voltage and Capacitance: 3.7 V & 2000mAh
Adapter	Brand name: MAGICON,QUE Model No. : HERO E50,QUE 5.0 Input: AC 100-240V, 50/60Hz, 0.2A    Output: DC 5V, 1000mA
Earphone	Brand name: N/A Model No. : N/A
Note:CMU200 can measure the average power and Peak power at the same time	
Product	Type
	<input checked="" type="checkbox"/> Production unit <input type="checkbox"/> Identical Prototype

## 2.2. Test Procedure

1	Setup the EUT and simulators as shown on above.
2	Turn on the power of all equipment.
3	EUT Communicate with 8960, and test them respectively at U.S. bands

## 2.3. Test Environment

Ambient conditions in the laboratory:

Items	Required	Actual
Temperature (°C)	18-25	21± 2
Humidity (%RH)	30-70	55±2



## 2.4. Test Configuration and setting

The EUT is a model of GSM Portable Mobile Station (MS). It supports GSM/GPRS/EGPRS, WCDMA/HSPA, BT, WIFI and hot spot mode.

For WWAN SAR testing, the device was controlled by using a base station emulator. Communication between the device and the emulator were established by air link. The distance between the EUT and the antenna is larger than 50cm, and the output power radiated from the emulator antenna is at least 30db smaller than the output power of EUT.

For WLAN testing, the EUT is configured with the WLAN continuous TX tool through engineering command.

### Antenna Location:

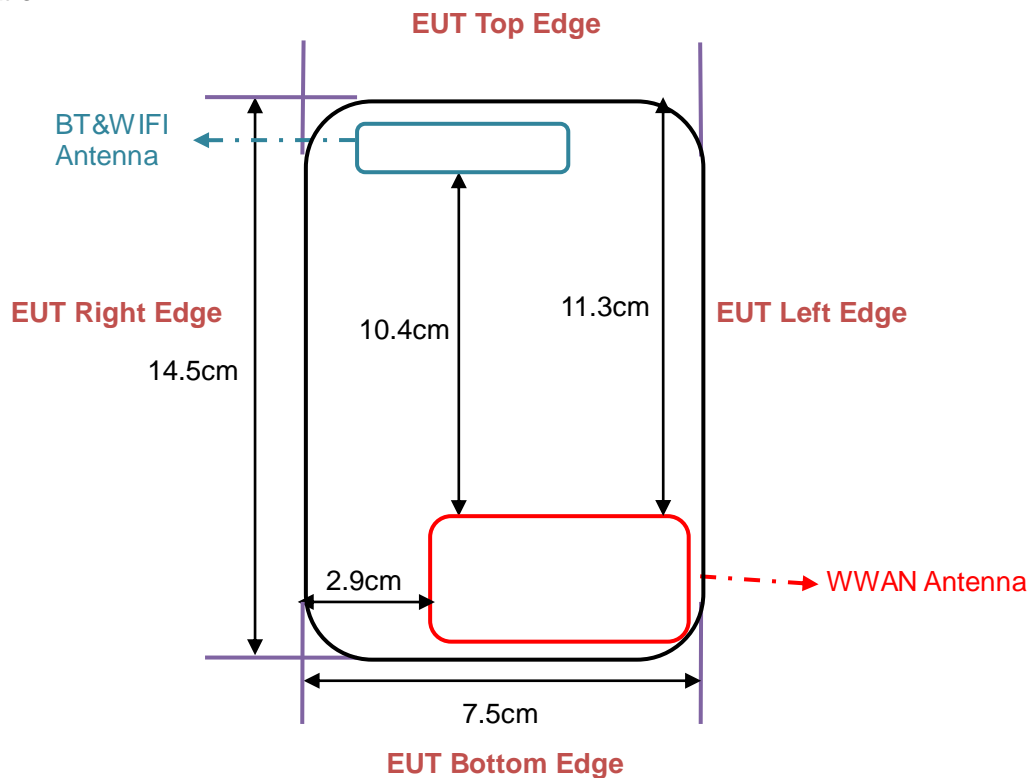

The separation distance for antenna to edge:

Antenna	To Top Side(cm)	To Bottom Side(cm)	To Left Side(cm)	To Right Side(cm)
WWAN	11.3	0.1	0.1	2.9
BT/WIFI	0.1	13.1	2.4	1.4

The simultaneous transmission possibilities are listed as below:

Simultaneous TX Combination	Configuration	Head	Body	Hotspot
1	GSM835(Voice)+WLAN/BT	Yes	Yes	Yes
2	PCS 1900(Voice)+WLAN/BT	Yes	Yes	Yes
3	WCDMA Band II+WLAN/BT	Yes	Yes	Yes
4	WCDMA Band V +WLAN/BT	Yes	Yes	Yes
5	WCDMA Band IV +WLAN/BT	Yes	Yes	Yes

### 3. SAR MEASUREMENT SYSTEM

#### 3.1. Specific Absorption Rate (SAR)

SAR is related to the rate at which energy is absorbed per unit mass in object exposed to a radio field. The SAR distribution in a biological body is complicated and is usually carried out by experimental techniques or numerical modeling. The standard recommends limits for two tiers of groups, occupational/controlled and occupational/uncontrolled, based on a person's awareness and ability to exercise control over his or her exposure. In general, occupational/controlled exposure limits are higher than the limits for general population/uncontrolled.

The SAR definition is the time derivative (rate) of the incremental energy (dW) absorbed by (dissipated in) an incremental mass (dm) contained in a volume (dv) of given mass density ( $\rho$ ). The equation description is as below:

$$SAR = \frac{d}{dt} \left( \frac{dW}{dm} \right) = \frac{d}{dt} \left( \frac{dW}{\rho dV} \right)$$

SAR is expressed in units of Watts per kilogram (W/Kg)

SAR can be obtained using either of the following equations:

$$SAR = \frac{\sigma E^2}{\rho}$$

$$SAR = c_h \left. \frac{dT}{dt} \right|_{t=0}$$

Where

SAR	is the specific absorption rate in watts per kilogram;
E	is the r.m.s. value of the electric field strength in the tissue in volts per meter;
$\sigma$	is the conductivity of the tissue in siemens per metre;
$\rho$	is the density of the tissue in kilograms per cubic metre;
$c_h$	is the heat capacity of the tissue in joules per kilogram and Kelvin;

$\left. \frac{dT}{dt} \right|_{t=0}$  is the initial time derivative of temperature in the tissue in kelvins per second

### **3.2. SAR Measurement Procedure**

The EUT is set to transmit at the required power in line with product specification, at each frequency relating to the LOW, MID, and HIGH channel settings.

Pre-scans are made on the device to establish the location for the transmitting antenna, using a large area scan in either air or tissue simulation fluid.

The EUT is placed against the Universal Phantom where the maximum area scan dimensions are larger than the physical size of the resonating antenna. When the scan size is not large enough to cover the peak SAR distribution, it is modified by either extending the area scan size in both the X and Y directions, or the device is shifted within the predefined area.

The area scan is then run to establish the peak SAR location (interpolated resolution set at  $1\text{mm}^2$ ) which is then used to orient the center of the zoom scan. The zoom scan is then executed and the 1g and 10g averages are derived from the zoom scan volume (interpolated resolution set at  $1\text{mm}^3$ ).

When multiple peak SAR location were found during the same configuration or test mode, Zoom scan shall performed on each peak SAR location, only the peak point with maximum SAR value will be reported for the configuration or test mode.

### 3.3. COMOSAR System Description

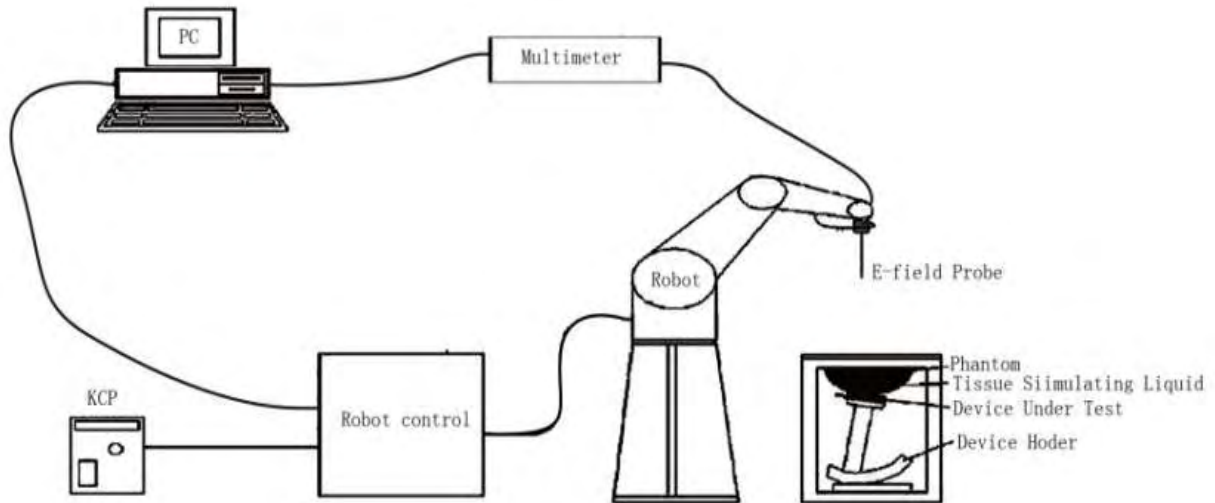

The COMOSAR system for performing compliance tests consists of the following items:

- The PC. It controls most of the bench devices and stores measurement data. A computer running WinXP and the Opensar software.
- The E-Field probe. The probe is a 3-axis system made of 3 distinct dipoles. Each dipole returns a voltage in function of the ambient electric field.
- The Keithley multimeter measures each probe dipole voltages.
- The SAM phantom simulates a human head. The measurement of the electric field is made inside the phantom.
- The liquids simulate the dielectric properties of the human head tissues.
- The network emulator controls the mobile phone under test.
- The validation dipoles are used to measure a reference SAR. They are used to periodically check the bench to make sure that there is no drift of the system characteristics over time.
- The phantom, the device holder and other accessories according to the targeted measurement.

#### 3.3.1. Applications

Predefined procedures and evaluations for automated compliance testing with all worldwide standards, e.g., IEEE 1528, OET 65, IEC 62209-1, IEC 62209-2, EN 50360, EN 50383 and others.

### 3.3.2. Area Scans

Area scans are defined prior to the measurement process being executed with a user defined variable spacing between each measurement point (integral) allowing low uncertainty measurements to be conducted. Scans defined for FCC applications utilize a 10mm<sup>2</sup> step integral, with 1mm interpolation used to locate the peak SAR area used for zoom scan assessments.

When an Area Scan has measured all reachable points, it computes the field maxima found in the scanned area, within a range of the global maximum. The range (in dB) is specified in the standards for compliance testing. For example, a 2 dB range is required in IEEE 1528-2003, EN 50361 and IEC 62209 standards, whereby 3 dB is a requirement when compliance is assessed in accordance with the ARIB standard (Japan).

### 3.3.3. Zoom Scan (Cube Scan Averaging)

Zoom Scans are used to assess the peak spatial SAR values within a cubic averaging volume containing 1 g and 10 g of simulated tissue. A density of 1000 kg/m<sup>3</sup> is used to represent the head and body tissue density and not the phantom liquid density, in order to be consistent with the definition of the liquid dielectric properties, i.e. the side length of the 1 g cube is 10mm, with the side length of the 10 g cube 21,5mm.

The zoom scan integer steps can be user defined so as to reduce uncertainty, but normal practice for typical test applications utilize a physical step of 7x7x7 (5mmx5mmx5mm) providing a volume of 30mm in the X & Y axis, and 30mm in the Z axis.

### 3.3.4. Uncertainty of Inter-/Extrapolation and Averaging

In order to evaluate the uncertainty of the interpolation, extrapolation and averaged SAR calculation algorithms of the Post processor, COMOSAR allows the generation of measurement grids which are artificially predefined by analytically based test functions. Therefore, the grids of area scans and zoom scans can be filled with uncertainty test data, according to the SAR benchmark functions of IEEE 1528. The three analytical functions shown in equations as below are used to describe the possible range of the expected SAR distributions for the tested handsets. The field gradients are covered by the spatially flat distribution f1, the spatially steep distribution f3 and f2 accounts for H-field cancellation on the phantom/tissue surface.

$$f_1(x, y, z) = Ae^{-\frac{z}{2a}} \cos^2 \left( \frac{\pi \sqrt{x'^2 + y'^2}}{2 \cdot 5a} \right)$$

$$f_2(x, y, z) = Ae^{-\frac{z}{a}} \frac{a^2}{a^2 + x'^2} \left( 3 - e^{-\frac{2z}{a}} \right) \cos^2 \left( \frac{\pi y'}{2 \cdot 3a} \right)$$

$$f_3(x, y, z) = A \frac{a^2}{\frac{a^2}{4} + x'^2 + y'^2} \left( e^{-\frac{2z}{a}} + \frac{a^2}{2(a + 2z)^2} \right)$$

### 3.4. COMOSAR E-Field Probe

The SAR measurement is conducted with the dissymmetric probe manufactured by SATIMO. The probe is specially designed and calibrated for use in liquid with high permittivity. The dissymmetric probe has special calibration in liquid at different frequency. SATIMO conducts the probe calibration in compliance with international and national standards (e.g. IEEE 1528, EN62209-1, IEC 62209, etc.) under ISO17025. The calibration data are in Appendix D.

### 3.5. Isotropic E-Field Probe Specification

<b>Model</b>	SSE5	
<b>Manufacture</b>	SATIMO	
<b>Frequency</b>	0.3GHz-3GHz Linearity:±0.09dB(300MHz-3GHz)	
<b>Dynamic Range</b>	0.01W/Kg-100W/Kg Linearity:±0.09dB	
<b>Dimensions</b>	Overall length:330mm Length of individual dipoles:4.5mm Maximum external diameter:8mm Probe Tip external diameter:5mm Distance between dipoles/ probe extremity:2.7mm	
<b>Application</b>	High precision dosimetric measurements in any exposure scenario (e.g., very strong gradient fields). Only probe which enables compliance testing for frequencies up to 3 GHz with precision of better 30%.	

### 3.6. Robot

The COMOSAR system uses the KUKA robot from SATIMO SA (France).For the 6-axis controller COMOSAR system, the KUKA robot controller version from SATIMO is used.

The XL robot series have many features that are important for our application:

- High precision (repeatability 0.02 mm)
- High reliability (industrial design)
- Jerk-free straight movements
- Low ELF interference (the closed metallic construction shields against motor control fields)
- 6-axis controller



### 3.7. Video Positioning System

The video positioning system is used in OpenSAR to check the probe. Which is composed of a camera, LED, mirror and mechanical parts. The camera is piloted by the main computer with firewire link.

During the process, the actual position of the probe tip with respect to the robot arm is measured, as well as the probe length and the horizontal probe offset. The software then corrects all movements, such that the robot coordinates are valid for the probe tip.

The repeatability of this process is better than 0.1 mm. If a position has been taught with an aligned probe, the same position will be reached with another aligned probe within 0.1 mm, even if the other probe has different dimensions. During probe rotations, the probe tip will keep its actual position.

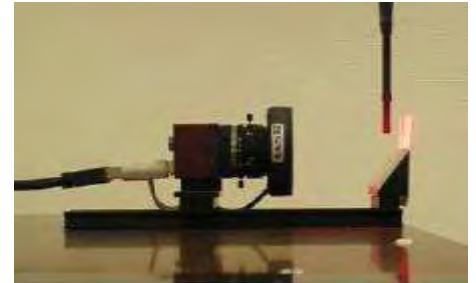

### 3.8. Device Holder

The COMOSAR device holder is designed to cope with different positions given in the standard. It has two scales for the device rotation (with respect to the body axis) and the device inclination (with respect to the line between the ear reference points). The rotation center for both scales is the ear reference point (EPR).

Thus the device needs no repositioning when changing the angles.

The COMOSAR device holder has been made out of low-loss POM material having the following dielectric parameters: relative permittivity  $\epsilon_r = 3$  and loss tangent  $\delta = 0.02$ . The amount of dielectric material has been reduced in the closest vicinity of the device, since measurements have suggested that the influence of the clamp on the test results could thus be lowered.

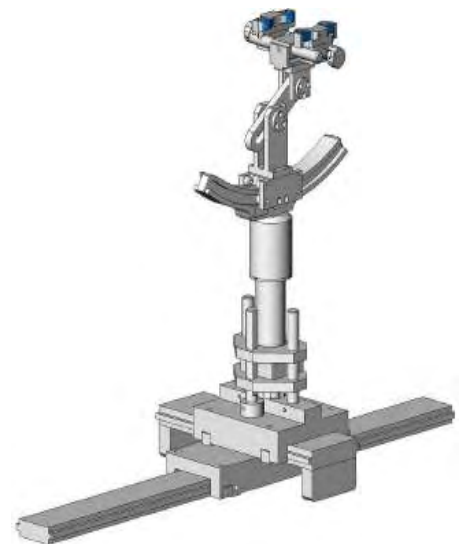

### 3.9. SAM Twin Phantom

The SAM twin phantom is a fiberglass shell phantom with 2mm shell thickness (except the ear region where shell thickness increases to 6mm). It has three measurement areas:

- Left head
- Right head
- Flat phantom

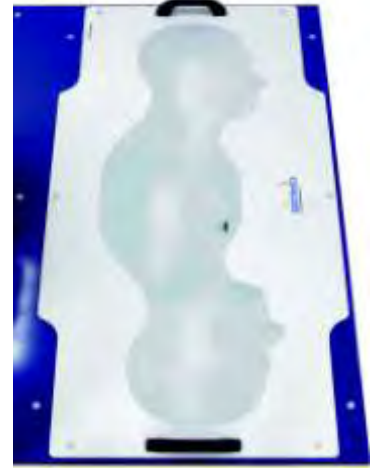

The bottom plate contains three pair of bolts for locking the device holder. The device holder positions are adjusted to the standard measurement positions in the three sections. A white cover is provided to tap the phantom during off-periods to prevent water evaporation and changes in the liquid parameters. On the phantom top, three reference markers are provided to identify the phantom position with respect to the robot.





## 4.2. Tissue Calibration Result

The dielectric parameters of the liquids were verified prior to the SAR evaluation using COMOSAR Dielectric Probe Kit and R&S Network Analyzer ZVL6 .

Tissue Stimulant Measurement for GSM835							
Fr. (MHz)	Ch.	Dielectric Parameters ( $\pm 5\%$ )				Tissue Temp [°C]	Test time
		head		body			
		$\epsilon_r$	$\delta[s/m]$	$\epsilon_r$	$\delta[s/m]$		
		41.5 39.425-43.575	0.90 0.855-0.945	55.20 52.44-57.96	0.97 0.9215-1.0185		
835	128	41.75	0.90	55.27	0.96	21	July 24,2014
835	190	41.91	0.88	55.76	0.96	21	July 24,2014
835	251	41.82	0.91	55.41	0.94	21	July 24,2014

Tissue Stimulant Measurement for 1800MHz							
Fr. (MHz)	Ch.	Dielectric Parameters ( $\pm 5\%$ )				Tissue Temp [°C]	Test time
		head		body			
		$\epsilon_r$	$\delta[s/m]$	$\epsilon_r$	$\delta[s/m]$		
		40.00 38.00-42.00	1.40 1.33-1.47	53.30 50.635-55.965	1.52 1.444-1.596		
1800	Low	40.73	1.42	53.18	1.49	21	July 24,2014
1800	Mid	40.16	1.38	53.17	1.50	21	July 24,2014
1800	High	40.50	1.37	53.55	1.53	21	July 24,2014

Tissue Stimulant Measurement for PCS 1900							
Fr. (MHz)	Ch.	Dielectric Parameters ( $\pm 5\%$ )				Tissue Temp [°C]	Test time
		head		body			
		$\epsilon_r$	$\delta[s/m]$	$\epsilon_r$	$\delta[s/m]$		
		40.00 38.00-42.00	1.40 1.33-1.47	53.30 50.635-55.965	1.52 1.444-1.596		
1900	512	40.33	1.39	53.74	1.50	21	July 24,2014
1900	661	40.41	1.42	53.79	1.53	21	July 24,2014
1900	810	40.65	1.40	53.84	1.50	21	July 24,2014

Tissue Stimulant Measurement for 2450MHz							
Fr. (MHz)	Ch.	Dielectric Parameters ( $\pm 5\%$ )				Tissue Temp [°C]	Test time
		head		body			
		$\epsilon_r$	$\delta[s/m]$	$\epsilon_r$	$\delta[s/m]$		
		39.2 37.24-41.16	1.80 1.71-1.89	52.7 50.065-55.335	1.95 1.8525-2.0475		
2450	1	39.22	1.77	52.13	1.90	21	July 24,2014
2450	6	39.46	1.82	52.55	1.87	21	July 24,2014
2450	11	39.58	1.79	52.08	1.89	21	July 24,2014

### 4.3. Tissue Dielectric Parameters for Head and Body Phantoms

The head tissue dielectric parameters recommended by the IEEE SCC-34/SC-2 in P1528 have been incorporated in the following table. These head parameters are derived from planar layer models simulating the highest expected SAR for the dielectric properties and tissue thickness variations in a human head. Other head and body tissue parameters that have not been specified in P1528 are derived from the tissue dielectric parameters computed from the 4-Cole-Cole equations described in Reference [12] and extrapolated according to the head parameters specified in P1528.

Target Frequency (MHz)	head		body	
	$\epsilon_r$	$\sigma$ (S/m)	$\epsilon_r$	$\sigma$ (S/m)
300	45.3	0.87	58.2	0.92
450	43.5	0.87	56.7	0.94
<b>835</b>	<b>41.5</b>	<b>0.90</b>	<b>55.2</b>	<b>0.97</b>
900	41.5	0.97	55.0	1.05
915	41.5	1.01	55.0	1.06
1450	40.5	1.20	54.0	1.30
1610	40.3	1.29	53.8	1.40
<b>1800 – 2000</b>	<b>40.0</b>	<b>1.40</b>	<b>53.3</b>	<b>1.52</b>
<b>2450</b>	<b>39.2</b>	<b>1.80</b>	<b>52.7</b>	<b>1.95</b>
3000	38.5	2.40	52.0	2.73
5800	35.3	5.27	48.2	6.00

( $\epsilon_r$  = relative permittivity,  $\sigma$  = conductivity and  $\rho = 1000$  kg/m<sup>3</sup>)

## 5. SAR MEASUREMENT PROCEDURE

### 5.1. SAR System Validation Procedures

Each SATIMO system is equipped with one or more system validation kits. These units, together with the predefined measurement procedures within the SATIMO software, enable the user to conduct the system performance check and system validation. System kit includes a dipole, and dipole device holder.

The system check verifies that the system operates within its specifications. It's performed daily or before every SAR measurement. The system check uses normal SAR measurement in the flat section of the phantom with a matched dipole at a specified distance. The system validation setup is shown as below.

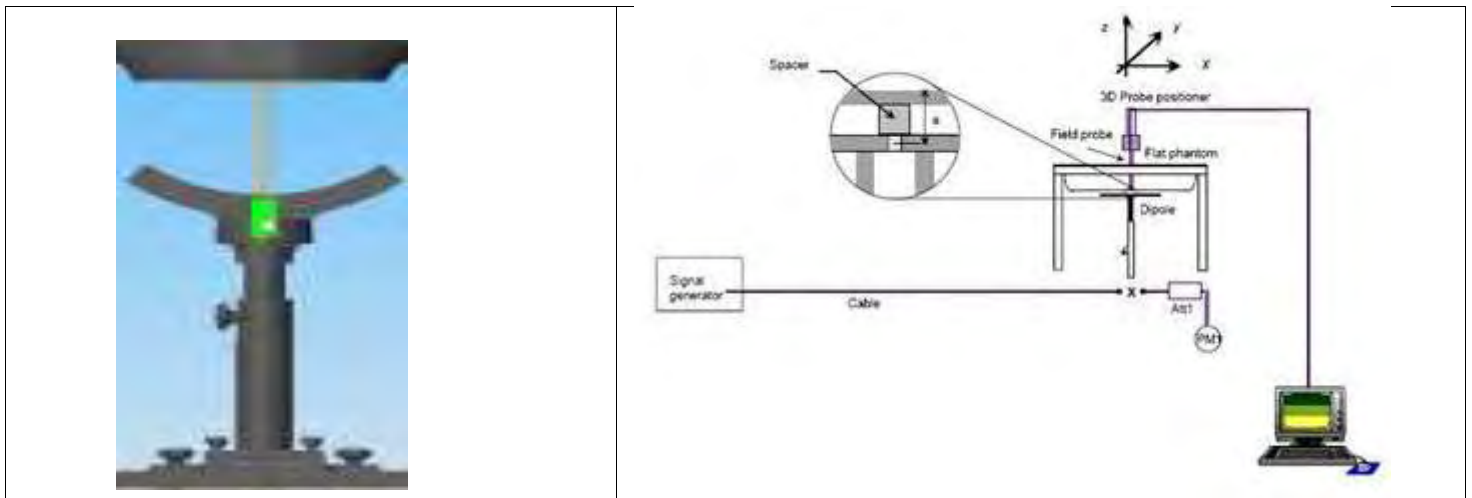

**5.2. SAR System Validation**  
**5.2.1. Validation Dipoles**

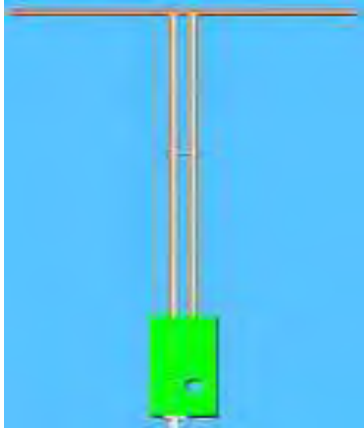

The dipoles used is based on the IEEE-1528 standard, and is complied with mechanical and electrical specifications in line with the requirements of both IEEE and FCC Supplement C. the table below provides details for the mechanical and electrical Specifications for the dipoles.

Frequency	L (mm)	h (mm)	d (mm)
900 MHz	149.0	83.3	3.6
1800MHz	71.6	41.7	3.6
1900MHz	68	39.5	3.6
2450MHz	51.5	30.4	3.6

### 5.2.2. Validation Result

System Performance Check at 835 MHz &1800MHz &1900MHz & 2450MHz for Head								
Validation Kit: SN 46/11DIP 0G900-185 & SN 46/11DIP 1G900-186 & SN 46/11DIP 1G900-187 &SN 46/11DIP 2G450-189								
Frequency [MHz]	Target Value(W/Kg)		Reference Result ( $\pm 10\%$ )		Tested Value(W/Kg)		Tissue Temp. [°C]	Test time
	1g	10g	1g	10g	1g	10g		
835	10.70	6.72	9.63-11.77	6.048-7.392	10.41	6.66	21	July 24,2014
1800	38.17	19.98	34.353-41.987	17.982-21.978	38.51	21.21	21	July 24,2014
1900	39.65	20.24	35.685-43.615	18.216-22.264	40.32	20.29	21	July 24,2014
2450	54.40	23.75	48.96-59.84	21.375-26.125	49.97	23.32	21	July 24,2014

System Performance Check at 835 MHz &1800MHz &1900MHz & 2450MHz for Body								
Validation Kit: SN 46/11DIP 0G900-185 & SN 46/11DIP 1G900-186 & SN 46/11DIP 1G900-187 &SN 46/11DIP 2G450-189								
Frequency [MHz]	Target Value(W/Kg)		Reference Result ( $\pm 10\%$ )		Tested Value(W/Kg)		Tissue Temp. [°C]	Test time
	1g	10g	1g	10g	1g	10g		
835	11.27	7.18	10.143-12.397	6.462-7.898	10.71	6.88	21	July 24,2014
1800	38.28	20.89	34.452-42.108	18.801-22.979	39.90	20.42	21	July 24,2014
1900	40.74	21.43	36.666-44.814	19.287-23.573	40.88	21.15	21	July 24,2014
2450	54.19	24.96	48.771-59.609	22.464-27.456	49.83	24.23	21	July 24,2014

## 6. EUT TEST POSITION

This EUT was tested in **Right Cheek, Right Titled, Left Cheek, Left Titled, Front Face and Rear Face.**

### 6.1. Define Two Imaginary Lines on the Handset

- (1)The vertical centerline passes through two points on the front side of the handset the midpoint of the width  $w_t$  of the handset at the level of the acoustic output, and the midpoint of the width  $w_b$  of the handset.
- (2)The horizontal line is perpendicular to the vertical centerline and passes through the center of the acoustic output. The horizontal line is also tangential to the face of the handset at point A.
- (3)The two lines intersect at point A. Note that for many handsets, point A coincides with the center of the acoustic output; however, the acoustic output may be located elsewhere on the horizontal line. Also note that the vertical centerline is not necessarily to the front face of the handset, especially for clamshell handsets, handsets with flip covers, and other irregularly shaped handsets.

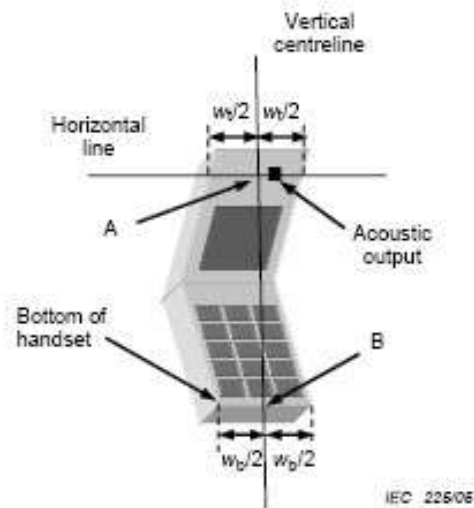
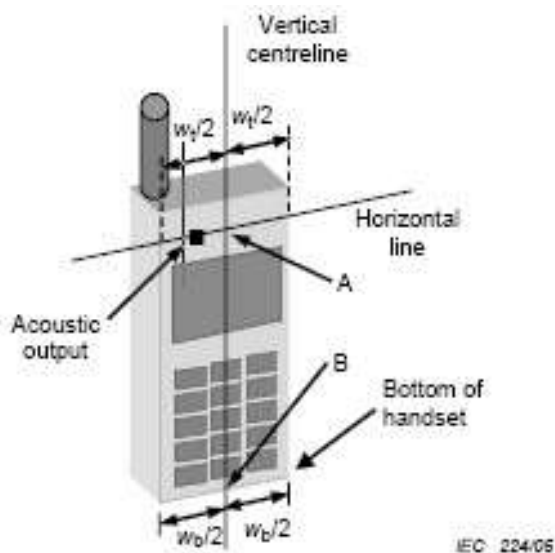

## 6.2. Cheek Position

- (1) To position the device with the vertical center line of the body of the device and the horizontal line crossing the center piece in a plane parallel to the sagittal plane of the phantom. While maintaining the device in this plane, align the vertical center line with the reference plane containing the ear and mouth reference point (M: Mouth, RE: Right Ear, and LE: Left Ear) and align the center of the ear piece with the line RE-LE.
- (2) To move the device towards the phantom with the ear piece aligned with the the line LE-RE until the phone touched the ear. While maintaining the device in the reference plane and maintaining the phone contact with ear, move the bottom of the phone until any point on the front side is in contact with the cheek of the phantom or until contact with the ear is lost



## 6.3. Title Position

- (1) To position the device in the “cheek” position described above.
- (2) While maintaining the device in the reference plane described above and pivoting against the ear, moves it outward away from the mouth by an angle of 15 degrees or until with the ear is lost.





#### 6.4. Body Worn Position

- (1) To position the EUT parallel to the phantom surface.
- (2) To adjust the EUT parallel to the flat phantom.
- (3) To adjust the distance between the EUT surface and the flat phantom to **10mm**. (Hotspot mode the distance of **10mm**).

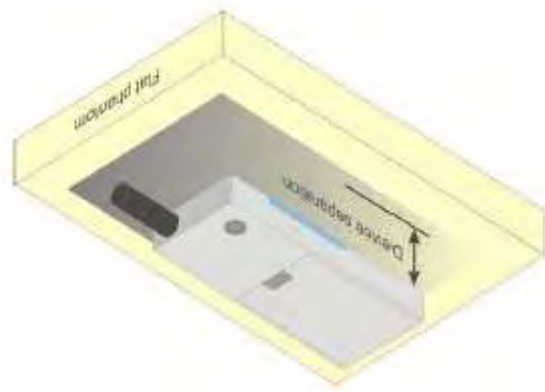

## 7. SAR EXPOSURE LIMITS

SAR assessments have been made in line with the requirements of IEEE-1528, FCC Supplement C, and comply with ANSI/IEEE C95.1-1992 "Uncontrolled Environments" limits. These limits apply to a location which is deemed as "Uncontrolled Environment" which can be described as a situation where the general public may be exposed to an RF source with no prior knowledge or control over their exposure.

### Limits for General Population/Uncontrolled Exposure (W/kg)

Type Exposure	Uncontrolled Environment Limit
Spatial Peak SAR (1g cube tissue for brain or body)	1.60 W/kg

## 8. TEST EQUIPMENT LIST

Equipment description	Manufacturer/ Model	Identification No.	Current calibration date	Next calibration date
SAR Probe	SATIMO	SN 22/12 EP159	01/12/2014	01/11/2015
TISSUE Probe	SATIMO	SN 45/11 OCPG45	11/14/2013	11/13/2015
Phantom	SATIMO	SN_4511_SAM90	Validated. No cal required.	Validated. No cal required.
Liquid	SATIMO	-	Validated. No cal required.	Validated. No cal required.
Comm Tester	R&S - CMU200	069Y7-158-13-712	02/17/2014	02/16/2015
Comm Tester	Agilent-8960	GB46310822	02/17/2014	02/16/2015
Multimeter	Keithley 2000	1188656	02/17/2014	02/16/2015
Dipole	SATIMO SID900	SN46/11 DIP 0G900-185	11/14/2013	11/13/2015
Dipole	SATIMO SID1800	SN46/11 DIP 1G800-186	11/14/2013	11/13/2015
Dipole	SATIMO SID1900	SN46/11 DIP 1G900-187	11/14/2013	11/13/2015
Dipole	SATIMO SID2450	SN46/11 DIP 2G450-189	11/14/2013	11/13/2015
Signal Generator	Agilent- E4438C	MY44260051	02/23/2014	02/22/2015
Power Probe	HP E4418A	US38261498	02/17/2014	02/16/2015
SPECTRUM ANALYZER	Agilent/E4440A	MY44303916	10/22/2013	10/21/2014
Network Analyzer	Rhode & Schwarz ZVA	SN100132	02/17/2014	02/16/2015

Note: Per KDB 865664 Dipole SAR Validation Verification, AGC Lab has adopted 3 years calibration intervals. On annual basis, every measurement dipole has been evaluated and is in compliance with the following criteria:

1. There is no physical damage on the dipole;
2. System validation with specific dipole is within 10% of calibrated value;
3. Return-loss is within 20% of calibrated measurement;
4. Impedance is within 5Ω of calibrated measurement.

## 9. MEASUREMENT UNCERTAINTY

<b>SATIMO Uncertainty</b>									
Measurement uncertainty for 300MHz to 3GHz averaged over 1 gram / 10 gram.									
Error Description	Sec	Sec	Tol (±%)	Prob. Dist.	(Ci) 1g	(Ci) 10g	Std. Unc. (1g) (±%)	Std. Unc. (10g)(±%)	(Vi) Veff
<b>Measurement System</b>									
Probe Calibration	E.2.1	6	N	1	1	1	6	6	∞
Axial Isotropy	E.2.2	3	R	$\sqrt{3}$	$(1 - C_p)^{1/2}$	$(1 - C_p)^{1/2}$	1.22474	1.22474	∞
Hemispherical Isotropy	E.2.2	5	R	$\sqrt{3}$	$\sqrt{C_p}$	$\sqrt{C_p}$	2.04124	2.04124	∞
Boundary Effects	E.2.3	1	R	$\sqrt{3}$	1	1	0.57735	0.57735	∞
Linearity	E.2.4	5	R	$\sqrt{3}$	1	1	2.88675	2.88675	∞
System Detection Limits	E.2.5	1	R	$\sqrt{3}$	1	1	0.57735	0.57735	∞
Readout Electronics	E.2.6	0.5	N	1	1	1	0.5	0.5	∞
Response Time	E.2.7	0.2	R	$\sqrt{3}$	1	1	0.11547	0.11547	∞
Integration Time	E.2.8	2	R	$\sqrt{3}$	1	1	1.1547	1.1547	∞
RF Ambient Noise	E.6.1	3	R	$\sqrt{3}$	1	1	1.73205	1.73205	∞
Probe Positioner Mechanical Tolerance	E.6.2	2	R	$\sqrt{3}$	1	1	1.1547	1.1547	∞
Probe Positioning with Respect to Phantom Shell	E.6.3	1	R	$\sqrt{3}$	1	1	0.57735	0.57735	∞
Extrapolation, interpolation and Integration Algorithms for Max. SAR Evaluation	E.5.2	1.5	R	$\sqrt{3}$	1	1	0.86603	0.86603	∞
<b>Dipole</b>									
Device Positioning	8,E.4.2	1	N	$\sqrt{3}$	1	1	0.57735	0.57735	N-1
Power Drift	8.6.6.2	2	R	$\sqrt{3}$	1	1	1.1547	1.1547	∞
<b>Phantom and Tissue Parameters</b>									
Phantom Uncertainty	E.3.1	4	R	$\sqrt{3}$	1	1	2.3094	2.3094	∞
Liquid Conductivity (target)	E.3.2	5	R	$\sqrt{3}$	0.64	0.43	1.84752	1.2413	∞
Liquid Conductivity (meas.)	E.3.3	2.5	N	1	0.64	0.43	1.6	1.075	∞
Liquid Permittivity (target)	E.3.2	3	R	$\sqrt{3}$	0.6	0.49	1.03923	0.8487	∞
Liquid Permittivity (meas.)	E.3.3	2.5	N	1	0.6	0.49	1.5	1.225	M
Combined Standard Uncertainty			RSS				8.09272	7.9296	
Expanded Uncertainty (95%CONFIDENCE INTERVAL)			k				16.18544	15.8592	

## 10. CONDUCTED POWER MEASUREMENT GSM BAND

Mode	Frequency(MHz)	Avg. Burst Power(dBm)	Duty cycle Factor(dBm)	Frame Power(dBm)
Maximum Power <1>				
GSM 835	824.2	31.82	-9	22.82
	836.6	31.85	-9	22.85
	848.8	<b>31.88</b>	-9	22.88
GPRS 835 (1 Slot)	824.2	31.83	-9	22.83
	836.6	31.79	-9	22.79
	848.8	31.85	-9	22.85
GPRS 835 (2 Slot)	824.2	28.71	-6	22.71
	836.6	28.68	-6	22.68
	848.8	28.74	-6	22.74
GPRS 835 (3 Slot)	824.2	26.68	-4.26	22.42
	836.6	26.66	-4.26	22.4
	848.8	26.73	-4.26	22.47
GPRS 835 (4 Slot)	824.2	25.59	-3	22.59
	836.6	25.55	-3	22.55
	848.8	25.62	-3	22.62
EGPRS 835 (1 Slot)	824.2	26.31	-9	17.31
	836.6	26.28	-9	17.28
	848.8	26.34	-9	17.34
EGPRS 835 (2 Slot)	824.2	24.66	-6	18.66
	836.6	24.62	-6	18.62
	848.8	24.68	-6	18.68
EGPRS 835 (3 Slot)	824.2	22.69	-4.26	18.43
	836.6	22.64	-4.26	18.38
	848.8	22.73	-4.26	18.47
EGPRS 835 (4 Slot)	824.2	21.76	-3	18.76
	836.6	21.75	-3	18.75
	848.8	21.79	-3	18.79

**GSM BAND CONTINUE**

Mode	Frequency(MHz)	Avg. Burst Power(dBm)	Duty cycle Factor(dBm)	Frame Power(dBm)
PCS1900	1850.2	<b>28.97</b>	-9	19.97
	1880	28.93	-9	19.93
	1909.8	28.86	-9	19.86
GPRS1900 (1 Slot)	1850.2	28.81	-9	19.81
	1880	28.78	-9	19.78
	1909.8	28.74	-9	19.74
GPRS1900 (2 Slot)	1850.2	25.76	-6	19.76
	1880	25.66	-6	19.66
	1909.8	25.62	-6	19.62
GPRS1900 (3 Slot)	1850.2	23.79	-4.26	19.53
	1880	23.77	-4.26	19.51
	1909.8	23.76	-4.26	19.5
GPRS1900 (4 Slot)	1850.2	22.78	-3	19.78
	1880	22.76	-3	19.76
	1909.8	22.72	-3	19.72
EGPRS1900 (1 Slot)	1850.2	25.21	-9	16.21
	1880	25.17	-9	16.17
	1909.8	25.16	-9	16.16
EGPRS1900 (2 Slot)	1850.2	23.82	-6	17.82
	1880	23.78	-6	17.78
	1909.8	23.75	-6	17.75
EGPRS1900 (3 Slot)	1850.2	22.18	-4.26	17.92
	1880	22.17	-4.26	17.91
	1909.8	22.14	-4.26	17.88
EGPRS1900 (4 Slot)	1850.2	20.87	-3	17.87
	1880	20.83	-3	17.83
	1909.8	20.82	-3	17.82
Maximum Power <2>				
GSM835	848.8	31.46	-9	22.46
PCS1900	1850.2	28.37	-9	19.37

Note 1:

The Frame Power (Source-based time-averaged Power) is scaled the maximum burst average power based on time slots. The calculated methods are show as following:

Frame Power = Max burst power (1 Up Slot) – 9 dB

Frame Power = Max burst power (2 Up Slot) – 6 dB

Frame Power = Max burst power (3 Up Slot) – 4.26 dB

Frame Power = Max burst power (4 Up Slot) – 3 dB

**UMTS BAND II**

<b>Mode</b>	<b>Frequency (MHz)</b>	<b>Avg. Burst Power (dBm)</b>
WCDMA 1900 RMC	1852.4	22.91
	1880	22.96
	1907.6	<b>22.97</b>
WCDMA 1900 AMR	1852.4	22.51
	1880	22.54
	1907.6	22.58
HSDPA Subtest 1	1852.4	22.42
	1880	22.44
	1907.6	22.49
HSDPA Subtest 2	1852.4	22.51
	1880	22.54
	1907.6	22.56
HSDPA Subtest 3	1852.4	22.48
	1880	22.52
	1907.6	22.53
HSDPA Subtest 4	1852.4	22.41
	1880	22.43
	1907.6	22.44
HSUPA Subtest 1	1852.4	22.43
	1880	22.47
	1907.6	22.49
HSUPA Subtest 2	1852.4	22.51
	1880	22.61
	1907.6	22.56
HSUPA Subtest 3	1852.4	22.56
	1880	22.52
	1907.6	22.47
HSUPA Subtest 4	1852.4	22.43
	1880	22.45
	1907.6	22.47
HSUPA Subtest 5	1852.4	22.46
	1880	22.48
	1907.6	22.45

**UMTS BAND IV**

<b>Mode</b>	<b>Frequency (MHz)</b>	<b>Avg. Burst Power (dBm)</b>
WCDMA 1700 RMC	1712.4	<b>22.78</b>
	1732.6	22.72
	1752.6	22.71
WCDMA 1700 AMR	1712.4	22.42
	1732.6	22.37
	1752.6	22.35
HSDPA Subtest 1	1712.4	22.41
	1732.6	22.36
	1752.6	22.32
HSDPA Subtest 2	1712.4	22.34
	1732.6	22.32
	1752.6	22.31
HSDPA Subtest 3	1712.4	22.32
	1732.6	22.28
	1752.6	22.27
HSDPA Subtest 4	1712.4	22.36
	1732.6	22.32
	1752.6	22.31
HSUPA Subtest 1	1712.4	22.35
	1732.6	22.32
	1752.6	22.27
HSUPA Subtest 2	1712.4	22.36
	1732.6	22.31
	1752.6	22.28
HSUPA Subtest 3	1712.4	22.36
	1732.6	22.35
	1752.6	22.31
HSUPA Subtest 4	1712.4	22.34
	1732.6	22.34
	1752.6	22.36
HSUPA Subtest 5	1712.4	22.35
	1732.6	22.38
	1752.6	22.29



**UMTS BAND V**

<b>Mode</b>	<b>Frequency (MHz)</b>	<b>Avg. Burst Power (dBm)</b>
WCDMA 835 RMC	826.4	<b>22.91</b>
	836.6	22.88
	846.6	22.86
WCDMA 835 AMR	826.4	22.49
	836.6	22.44
	846.6	22.42
HSDPA Subtest 1	826.4	22.45
	836.6	22.41
	846.6	22.38
HSDPA Subtest 2	826.4	22.44
	836.6	22.39
	846.6	22.35
HSDPA Subtest 3	826.4	22.44
	836.6	22.37
	846.6	22.35
HSDPA Subtest 4	826.4	22.58
	836.6	22.54
	846.6	22.48
HSUPA Subtest 1	826.4	22.53
	836.6	22.47
	846.6	22.42
HSUPA Subtest 2	826.4	22.53
	836.6	22.45
	846.6	22.37
HSUPA Subtest 3	826.4	22.52
	836.6	22.45
	846.6	22.32
HSUPA Subtest 4	826.4	22.44
	836.6	22.41
	846.6	22.34
HSUPA Subtest 5	826.4	22.45
	836.6	22.34
	846.6	22.32

**WIFI**

Mode	Data Rate (Mbps)	Channel	Frequency(MHz)	Avg. Burst Power(dBm)
802.11b	1	01	2412	<b>9.84</b>
		06	2437	9.78
		11	2462	9.35
802.11g	6	01	2412	7.24
		06	2437	7.18
		11	2462	7.13
802.11n(20)	6.5	01	2412	7.16
		06	2437	7.15
		11	2462	7.08
802.11n(40)	13.5	03	2422	4.48
		06	2437	4.43
		09	2452	4.4

**Bluetooth\_V3.0**

Modulation	Channel	Frequency(MHz)	Average Power (dBm)
GFSK	0	2402	3.12
	39	2441	4
	78	2480	<b>4.3</b>
$\pi/4$ -DQPSK	0	2402	2.43
	39	2441	3.16
	78	2480	3.49
8-DPSK	0	2402	2.4
	39	2441	3.34
	78	2480	3.56

According to 3GPP 25.101 sub-clause 6.2.2 , the maximum output power is allowed to be reduced by following the table.

Table 6.1aA: UE maximum output power with HS-DPCCH and E-DCH

UE Transmit Channel Configuration	CM(db)	MPR(db)
For all combinations of ,DPDCH,DPCCH HS-DPDCH,E-DPDCH and E-DPCCH	$0 \leq CM \leq 3.5$	$MAX(CM-1,0)$
Note: CM=1 for $\beta_c/\beta_d=12/15$ , $\beta_{hs}/\beta_c=24/15$ .For all other combinations of DPDCH, DPCCH, HS-DPCCH, E-DPDCH and E-DPCCH the MPR is based on the relative CM difference.		

The device supports MPR to solve linearity issues (ACLR or SEM) due to the higher peak-to average ratios (PAR) of the HSUPA signal. This prevents saturating the full range of the TX DAC inside of device and provides a reduced power output to the RF transceiver chip according to the Cubic Metric (a function of the combinations of DPDCH, DPCCH, HS-DPCCH, E-DPDCH and E-DPCCH).

When E-DPDCH channels are present the beta gains on those channels are reduced firsts to try to get the power under the allowed limit. If the beta gains are lowered as far as possible, then a hard limiting is applied at the maximum allowed level.

The SW currently recalculates the cubic metric every time the beta gains on the E-DPDCH are reduced. The cubic metric will likely get lower each time this is done .However, there is no reported reduction of maximum output power in the HSUPA mode since the device also provides a compensation for the power back-off by increasing the gain of TX\_AGC in the transceiver (PA) device.

The end effect is that the DUT output power is identical to the case where there is no MPR in the device.

## 11. TEST RESULTS

### 11.1. SAR Test Results Summary

#### 11.1.1. Test position and configuration

Head SAR was performed with the device configured in the positions according to IEEE1528, and Body SAR was performed with the device 10mm from the phantom; Body SAR was also performed with the headset attached and without. The overall device length and width(14.5cm×7.5cm) are >9cm×5cm, Hotspot mode with a test separation distance of 10mm.

#### 11.1.2. Operation Mode

- According to KDB 447498 D01 v05r01 ,for each exposure position, if the highest 1-g SAR is  $\leq 0.8$  W/kg, testing for low and high channel is optional.
- Per KDB 865664 D01 v01r01,for each frequency band, if the measured SAR is  $\geq 0.8$ W/Kg, testing for repeated SAR measurement is required , that the highest measured SAR is only to be tested. When the SAR results are near the limit, the following procedures are required for each device to verify these types of SAR measurement related variation concerns by repeating the highest measured SAR configuration in each frequency band.
  - (1) When the original highest measured SAR is  $\geq 0.8$ W/Kg, repeat that measurement once.
  - (2) Perform a second repeated measurement only if the ratio of largest to smallest SAR for the original and first repeated measurements is  $> 1.20$  or when the original or repeated measurement is  $\geq 1.45$  W/Kg.
  - (3) Perform a third repeated measurement only if the original, first and second repeated measurement is  $\geq 1.5$  W/Kg and ratio of largest to smallest SAR for the original, first and second measurement is  $\geq 1.20$ .
- Body-worn exposure conditions are intended to voice call operations, therefore GSM voice call mode is selected to be test.
- According to KDB 648474 D04 v01r01,when the reported SAR for a body-worn accessory measured without a headset connected to the handset is  $\leq 1.2$ W/Kg, SAR testing with a headset connected is not required.
- According to 941225 D06, when the overall device length and width are >9cm×5cm, Hotspot mode with a test separation distance of 10mm. For device with form factors smaller than 9cm×5cm, Hotspot mode with a test separation distance of 5mm. Body SAR was also performed with the headset attached and without.
- According to 248227 D01, SAR is not required for 802.11g channels when the maximum average output power is less than 1/4dB higher than measured on the corresponding 802.11b channels.
- Maximum Scaling SAR in order to calculate the Maximum SAR values to test under the standard Peak Power, Calculation method is as follows:  
Maximum Scaling SAR =tested SAR (Max.) × [maximum turn-up power (mw)/ maximum measurement output power(mw) ]

### 11.1.3. Test Result

SAR MEASUREMENT									
Ambient Temperature (°C) : 21 ± 2					Relative Humidity (%) : 55				
Liquid Temperature (°C) : 21 ± 2					Depth of Liquid (cm) : >15				
Product: Mobile Phone									
Test Mode: GSM835 with GMSK modulation									
Position	Mode	Ch.	Fr. (MHz)	Power Drift (<±5%)	SAR (1g) (W/kg)	Max. Turn-up Power (dBm)	Meas. output Power (dBm)	Scaled SAR (W/Kg)	Limit W/kg
<b>SIM 1 Card</b>									
Left Cheek	voice	190	836.6	-0.31	<b>0.384</b>	33	31.85	<b>0.500</b>	1.6
Left Tilt	voice	190	836.6	1.02	0.325	33	31.85	0.424	1.6
Right Cheek	voice	190	836.6	-0.66	0.353	33	31.85	0.460	1.6
Right Tilt	voice	190	836.6	1.03	0.375	33	31.85	0.489	1.6
Body back	voice	190	836.6	-0.96	<b>0.708</b>	33	31.85	<b>0.923</b>	1.6
Body front	voice	190	836.6	0.54	0.384	33	31.85	0.500	1.6
<b>SIM 2 Card</b>									
Left Cheek	voice	190	836.6	-0.61	0.363	33	31.85	0.473	1.6

Note:

- The test separation of all above table for body part is 10mm.
- The worst mode is voice mode.

SAR MEASUREMENT									
Ambient Temperature (°C) : 21 ± 2					Relative Humidity (%) : 55				
Liquid Temperature (°C) : 21 ± 2					Depth of Liquid (cm) : >15				
Product: Mobile Phone									
Test Mode: PCS1900 with GMSK modulation									
Position	Mode	Ch.	Fr. (MHz)	Power Drift (<±5%)	SAR (1g) (W/kg)	Max. Turn-up Power (dBm)	Meas. output Power (dBm)	Scaled SAR (W/Kg)	Limit W/kg
<b>SIM 1 Card</b>									
Left Cheek	voice	661	1880.0	-0.37	<b>0.323</b>	30	28.93	<b>0.413</b>	1.6
Left Tilt	voice	661	1880.0	1.02	0.156	30	28.93	0.200	1.6
Right Cheek	voice	661	1880.0	-0.45	0.243	30	28.93	0.311	1.6
Right Tilt	voice	661	1880.0	0.61	0.166	30	28.93	0.212	1.6
Body back	voice	661	1880.0	-0.59	<b>0.765</b>	30	28.93	<b>0.979</b>	1.6
Body front	voice	661	1880.0	1.33	0.263	30	28.93	0.336	1.6
<b>SIM 2 Card</b>									
Left Cheek	voice	661	1880.0	-1.38	0.306	30	28.93	0.391	1.6

Note:

- The test separation of all above table for body part is 10mm.
- The worst mode is voice mode.

SAR MEASUREMENT									
Ambient Temperature (°C) : 21 ± 2					Relative Humidity (%): 55				
Liquid Temperature (°C) : 21 ± 2					Depth of Liquid (cm):>15				
Product: Mobile Phone									
Test Mode: WCDMA Band II with QPSK modulation									
Position	Mode	Ch.	Fr. (MHz)	Power Drift (<±5%)	SAR (1g) (W/kg)	Max. Turn-up Power (dBm)	Meas. output Power (dBm)	Scaled SAR (W/Kg)	Limit W/kg
<b>SIM 1 Card</b>									
Left Cheek	RMC 12.2kbps	9400	1880	-0.37	0.776	23	22.96	0.783	1.6
Left Tilt	RMC 12.2kbps	9400	1880	0.51	0.346	23	22.96	0.349	1.6
Right Cheek	RMC 12.2kbps	9262	1852.4	1.94	0.635	23	22.91	0.648	1.6
Right Cheek	RMC 12.2kbps	9400	1880	-0.63	<b>0.874</b>	23	22.96	<b>0.882</b>	1.6
Right Cheek	RMC 12.2kbps	9538	1907.6	1.26	0.794	23	22.97	0.800	1.6
Right Tilt	RMC 12.2kbps	9400	1880	-0.33	0.203	23	22.96	0.205	1.6
Body back	RMC 12.2kbps	9262	1852.4	-1.57	1.074	23	22.91	1.096	1.6
Body back	RMC 12.2kbps	9400	1880	1.34	<b>1.104</b>	23	22.96	<b>1.114</b>	1.6
Body back	RMC 12.2kbps	9538	1907.6	-0.82	0.843	23	22.97	0.849	1.6
Body front	RMC 12.2kbps	9400	1880	0.33	0.757	23	22.96	0.764	1.6

Note:

- The test separation of all above table for body part is 10mm.
- The worst mode is voice mode.

SAR MEASUREMENT									
Ambient Temperature (°C) : 21 ± 2					Relative Humidity (%): 55				
Liquid Temperature (°C) : 21 ± 2					Depth of Liquid (cm):>15				
Product: Mobile Phone									
Test Mode: WCDMA Band V with QPSK modulation									
Position	Mode	Ch.	Fr. (MHz)	Power Drift (<±5%)	SAR (1g) (W/kg)	Max. Turn-up Power (dBm)	Meas. output Power (dBm)	Scaled SAR (W/Kg)	Limit W/kg
<b>SIM 1 Card</b>									
Left Cheek	RMC 12.2kbps	4183	836.6	-0.37	0.656	23	22.88	0.674	1.6
Left Tilt	RMC 12.2kbps	4183	836.6	0.33	<b>0.733</b>	23	22.88	<b>0.754</b>	1.6
Right Cheek	RMC 12.2kbps	4183	836.6	-0.51	0.656	23	22.88	0.674	1.6
Right Tilt	RMC 12.2kbps	4183	836.6	1.63	0.613	23	22.88	0.630	1.6
Body back	RMC 12.2kbps	4132	826.4	-1.49	0.964	23	22.91	0.984	1.6
Body back	RMC 12.2kbps	4183	836.6	-0.21	<b>1.178</b>	23	22.88	<b>1.211</b>	1.6
Body back	RMC 12.2kbps	4233	846.6	0.58	1.000	23	22.86	1.033	1.6
Body front	RMC 12.2kbps	4183	836.6	1.37	0.667	23	22.88	0.686	1.6

Note:

- The test separation of all above table for body part is 10mm.
- The worst mode is voice mode.

SAR MEASUREMENT									
Ambient Temperature (°C) : 21 ± 2					Relative Humidity (%): 55				
Liquid Temperature (°C) : 21 ± 2					Depth of Liquid (cm):>15				
Product: Mobile Phone									
Test Mode: WCDMA Band IV with QPSK modulation									
Position	Mode	Ch.	Fr. (MHz)	Power Drift (<±5%)	SAR (1g) (W/kg)	Max. Turn-up Power (dBm)	Meas. output Power (dBm)	Scaled SAR (W/Kg)	Limit W/kg
<b>SIM 1 Card</b>									
Left Cheek	RMC 12.2kbps	1413	1732.6	-0.37	0.574	23	22.72	0.612	1.6
Left Tilt	RMC 12.2kbps	1413	1732.6	0.59	0.347	23	22.72	0.370	1.6
Right Cheek	RMC 12.2kbps	1413	1732.6	-0.15	<b>0.667</b>	23	22.72	<b>0.711</b>	1.6
Right Tilt	RMC 12.2kbps	1413	1732.6	-1.64	0.427	23	22.72	0.455	1.6
Body back	RMC 12.2kbps	1312	1712.4	1.85	<b>1.175</b>	23	22.78	<b>1.236</b>	1.6
Body back	RMC 12.2kbps	1413	1732.6	1.33	1.032	23	22.72	1.101	1.6
Body back	RMC 12.2kbps	1513	1752.6	-0.24	1.035	23	22.71	1.106	1.6
Body front	RMC 12.2kbps	1413	1732.6	0.19	0.584	23	22.72	0.623	1.6

Note:

- The test separation of all above table for body part is 10mm.
- The worst mode is voice mode.

SAR MEASUREMENT									
Ambient Temperature (°C) : 21 ± 2					Relative Humidity (%): 55				
Liquid Temperature (°C) : 21 ± 2					Depth of Liquid (cm):>15				
Product: Mobile Phone									
Test Mode: Hotspot									
Position	Mode	Ch.	Fr. (MHz)	Power Drift (<±5%)	SAR (1g) (W/kg)	Max. Turn-up Power (dBm)	Meas. output Power (dBm)	Scaled SAR (W/Kg)	Limit W/kg
<b>SIM 1 Card</b>									
Body back	DTS	6	2437	0.12	<b>0.175</b>	10	9.78	<b>0.184</b>	1.6
Body front	DTS	6	2437	1.03	0.156	10	9.78	0.164	1.6

Note:

- According to KDB248227, SAR is not required for 802.11n HT20/HT40 channels when the maximum average output power is less than 1/4 dB higher than that measured on the corresponding 802.11a/b channels.
- All of above "DTS" means data transmitters.
- The test separation of all above table for body part is 10mm.

<b>Repeated SAR</b>								
Ambient Temperature (°C) : 21 ± 2				Relative Humidity (%): 55				
Liquid Temperature (°C) : 21 ± 2				Depth of Liquid (cm):>15				
Product: Mobile Phone								
Test Mode: WCDMA Band II& WCDMA Band V & WCDMA Band IV with QPSK modulation								
Position	Mode	Ch.	Fr. (MHz)	Power Drift (<±5%)	Once SAR (1g) (W/kg)	Twice SAR (1g) (W/kg)	Third SAR (1g) (W/kg)	Limit W/kg
Right Cheek	RMC 12.2kbps	9400	1880	-0.66	0.869	--	--	1.6
Body back	RMC 12.2kbps	9400	1880	1.24	1.096	--	--	1.6
Body back	RMC 12.2kbps	4183	836.6	-0.39	1.168	--	--	1.6
Body back	RMC 12.2kbps	1312	1712.4	1.34	1.171	--	--	1.6



**Simultaneous Multi-band Transmission Evaluation:**  
**Application Simultaneous Transmission information:**

NO	Simultaneous state	Portable Handset			Note
		Head	Body-worn	Hotspot	
1	GSM(voice)+WLAN 2.4GHz (data)	Yes	Yes	-	-
2	WCDMA(voice)+WLAN 2.4GHz (data)	Yes	Yes	-	-
3	GSM(voice)+Bluetooth(data)	Yes	Yes	-	-
4	WCDMA(voice)+Bluetooth(data)	Yes	Yes	-	-
5	GSM(voice)+WLAN 2.4GHz (data)	Yes	Yes	Yes	2.4GHz Hotspot
6	WCDMA(voice)+WLAN 2.4GHz (data)	Yes	Yes	Yes	2.4GHz Hotspot

**NOTE:**

1. WLAN and BT share the same antenna, and cannot transmit simultaneously.
2. Simultaneous with every transmitter must be the same test position.
3. Based upon KDB 447498 D01 v05, BT SAR is excluded as below table.
4. Based upon KDB 447498 D01 v05, for handsets the test separation distance is determined by the smallest distance between the outer surface of the device and the user; which is 0mm for head SAR AND 5mm for body-worn SAR.
5. If the test separation distance is <5mm, 5mm is used for excluded SAR calculation.
6. For minimum test separation distance  $\leq 50$ mm, Bluetooth standalone SAR is excluded according to  $[(\text{max. power of channel, including tune-up tolerance, mW}) / (\text{min. test separation distance, mm}) \cdot \sqrt{f \text{ (GHz)}} / x] \leq 3.0$  for 1-g SAR and  $\leq 7.5$  for 10-g extremity SAR
7. KDB 447498 / 4.3.2 (2) when standalone SAR test exclusion applies to an antenna that transmits simultaneously with other antennas, the standalone SAR must be estimated according to following to determine simultaneous transmission SAR test exclusion:
  - a)  $(\text{max. power of channel, including tune-up tolerance, mW}) / (\text{min. test separation distance, mm}) \cdot \sqrt{f \text{ (GHz)}} / x$  W/kg for test separation distances  $\leq 50$  mm; Where  $x = 7.5$  for 1-g SAR, and  $x = 18.75$  for 10-g SAR.
  - b) 0.4W/Kg for 1-g SAR and 1.0W/Kg for 10-g SAR, when the separation distance is >50mm.

		Maximum Average Power		Antenna to user (mm)	SAR exclusion threshold (mW)	SAR testing required (Yes/No)	Head (0mm gap)	Body (10 mm gap)
		dBm	mW					
<b>BT</b>	Head	5	3.162	5	10	NO	0.133 W/kg	0.066 W/kg
	Body			5	10	NO		
<b>WIFI</b>	Head	10	10	5	10	NO	0.414 W/kg	0.207 W/kg
	Body			5	10	NO		

**Maximum test results (WWAN) with BT and WIFI/ HOTSPOT SAR:**

**BT:** Head (0 cm gap): 0.133 W/kg and Body (1.0 cm gap): 0.066 W/kg

**WIFI:** Head (0 cm gap): 0.414 W/kg and Body (1.0 cm gap): 207 W/kg

**HOTSPOT:** Body (1.0cm gap): 0.184W/kg

**WIFI**

Position	Max. WWAN SAR (W/Kg)	Estimated SAR (W/Kg)	SAR Summation	Limit (W/kg)	SPLSR $\leq 0.04$ (Yes/No)
<b>GSM850+WLAN 2.4G-DTS</b>					
Left Cheek	0.500	0.414	<b>0.914</b>	1.6	No
Left Tilt	0.424	0.414	0.838	1.6	No
Right Cheek	0.460	0.414	0.874	1.6	No
Right Tilt	0.489	0.414	0.903	1.6	No
Body back	0.923	0.207	<b>1.130</b>	1.6	No
Body front	0.500	0.207	0.707	1.6	No
<b>PCS1900+WLAN 2.4G-DTS</b>					
Left Cheek	0.413	0.414	<b>0.827</b>	1.6	No
Left Tilt	0.200	0.414	0.614	1.6	No
Right Cheek	0.311	0.414	0.725	1.6	No
Right Tilt	0.212	0.414	0.626	1.6	No
Body back	0.979	0.207	<b>1.186</b>	1.6	No
Body front	0.336	0.207	0.543	1.6	No
<b>WCDMA Band II +WLAN 2.4G-DTS</b>					
Left Cheek	0.783	0.414	1.197	1.6	No
Left Tilt	0.349	0.414	0.763	1.6	No
Right Cheek	0.882	0.414	<b>1.296</b>	1.6	No
Right Tilt	0.205	0.414	0.619	1.6	No
Body back	1.114	0.207	<b>1.321</b>	1.6	No
Body front	0.764	0.207	0.971	1.6	No
<b>WCDMA Band V +WLAN 2.4G-DTS</b>					
Left Cheek	0.674	0.414	1.088	1.6	No
Left Tilt	0.754	0.414	<b>1.168</b>	1.6	No
Right Cheek	0.674	0.414	1.088	1.6	No
Right Tilt	0.630	0.414	1.044	1.6	No
Body back	1.211	0.207	<b>1.418</b>	1.6	No
Body front	0.686	0.207	0.893	1.6	No
<b>WCDMA Band IV +WLAN 2.4G-DTS</b>					
Left Cheek	0.612	0.414	1.026	1.6	No
Left Tilt	0.370	0.414	0.784	1.6	No
Right Cheek	0.711	0.414	<b>1.125</b>	1.6	No
Right Tilt	0.455	0.414	0.869	1.6	No
Body back	1.101	0.207	<b>1.308</b>	1.6	No
Body front	0.623	0.207	0.830	1.6	No

**Note:**

- According to KDB 447498 D01 General RF Exposure Guidance v05, when the simultaneous transmission SAR is less than 1.6 W/Kg, SPLSR assessment is not required.
- SPLSR mean is “The SAR to Peak Location Separation Ratio “

### HOTSPOT

Position	Max. WWAN SAR (W/Kg)	Hotspot SAR (W/Kg)	SAR Summation	Limit (W/kg)	SPLSR $\leq 0.04$ (Yes/No)
<b>GSM850+Hotspot</b>					
Body back	0.923	0.184	<b>1.107</b>	1.6	No
Body front	0.500	0.164	0.664	1.6	No
<b>PCS1900+ Hotspot</b>					
Body back	0.979	0.184	<b>1.163</b>	1.6	No
Body front	0.336	0.164	0.500	1.6	No
<b>WCDMA Band II + Hotspot</b>					
Body back	1.114	0.184	<b>1.298</b>	1.6	No
Body front	0.764	0.164	0.928	1.6	No
<b>WCDMA Band V + Hotspot</b>					
Body back	1.211	0.184	<b>1.395</b>	1.6	No
Body front	0.686	0.164	0.850	1.6	No
<b>WCDMA Band IV + Hotspot</b>					
Body back	1.101	0.184	<b>1.285</b>	1.6	No
Body front	0.623	0.164	0.787	1.6	No

**Note:**

- According to KDB 447498 D01 General RF Exposure Guidance v05, when the simultaneous transmission SAR is less than 1.6 W/Kg, SPLSR assessment is not required.
- SPLSR mean is “The SAR to Peak Location Separation Ratio “

**BT**

Position	Max. WWAN SAR (W/Kg)	Estimated SAR (W/Kg)	SAR Summation	Limit (W/kg)	SPLSR $\leq 0.04$ (Yes/No)
<b>GSM850+BT</b>					
Left Cheek	0.500	0.133	<b>0.633</b>	1.6	No
Left Tilt	0.424	0.133	0.557	1.6	No
Right Cheek	0.460	0.133	0.593	1.6	No
Right Tilt	0.489	0.133	0.622	1.6	No
Body back	0.923	0.066	<b>0.989</b>	1.6	No
Body front	0.500	0.066	0.566	1.6	No
<b>PCS1900+BT</b>					
Left Cheek	0.413	0.133	<b>0.546</b>	1.6	No
Left Tilt	0.200	0.133	0.333	1.6	No
Right Cheek	0.311	0.133	0.444	1.6	No
Right Tilt	0.212	0.133	0.345	1.6	No
Body back	0.979	0.066	<b>1.045</b>	1.6	No
Body front	0.336	0.066	0.402	1.6	No
<b>WCDMA Band II +WLAN 2.4G-DTS</b>					
Left Cheek	0.783	0.133	0.916	1.6	No
Left Tilt	0.349	0.133	0.482	1.6	No
Right Cheek	0.882	0.133	<b>1.015</b>	1.6	No
Right Tilt	0.205	0.133	0.338	1.6	No
Body back	1.114	0.066	<b>1.180</b>	1.6	No
Body front	0.764	0.066	0.830	1.6	No
<b>WCDMA Band V +WLAN 2.4G-DTS</b>					
Left Cheek	0.674	0.133	0.807	1.6	No
Left Tilt	0.754	0.133	<b>0.887</b>	1.6	No
Right Cheek	0.674	0.133	0.807	1.6	No
Right Tilt	0.630	0.133	0.763	1.6	No
Body back	1.211	0.066	<b>1.277</b>	1.6	No
Body front	0.686	0.066	0.752	1.6	No
<b>WCDMA Band IV +WLAN 2.4G-DTS</b>					
Left Cheek	0.612	0.133	0.745	1.6	No
Left Tilt	0.370	0.133	0.503	1.6	No
Right Cheek	0.711	0.133	<b>0.844</b>	1.6	No
Right Tilt	0.455	0.133	0.588	1.6	No
Body back	1.101	0.066	<b>1.167</b>	1.6	No
Body front	0.623	0.066	0.689	1.6	No

**Note:**

- According to KDB 447498 D01 General RF Exposure Guidance v05, when the simultaneous transmission SAR is less than 1.6 W/Kg, SPLSR assessment is not required.
- SPLSR mean is “The SAR to Peak Location Separation Ratio “

## APPENDIX A. SAR SYSTEM VALIDATION DATA

Test Laboratory: AGC Lab

Date: July 24,2014

System Check Head 835 MHz

DUT: Dipole 900 MHz Type: SID 900

Communication System CW; Communication System Band: D835 (835.0 MHz); Duty Cycle: 1:1; Conv.F=5.27

Frequency: 835 MHz; Medium parameters used:  $f = 835$  MHz;  $\sigma=0.88$  mho/m;  $\epsilon_r =41.91$ ;  $\rho= 1000$  kg/m<sup>3</sup> ;

Phantom section: Flat Section; Input Power=10dBm

Ambient temperature (°C): 21, Liquid temperature (°C): 21

SATIMO Configuration:

- Probe: SSE5; Calibrated: 01/12/2014; Serial No.:SN 22/12 EP159
- Sensor-Surface: 4mm (Mechanical Surface Detection)
- Phantom: Flat Phantom; Type: Elliptical Phantom
- Measurement SW: OpenSAR V4\_02\_01

Configuration/System Check GSM 835 Head/Area Scan: Measurement grid: dx=8mm, dy=8mm

Configuration/System Check GSM 835 Head/Zoom Scan: Measurement grid: dx=8mm, dy=8mm, dz=5mm

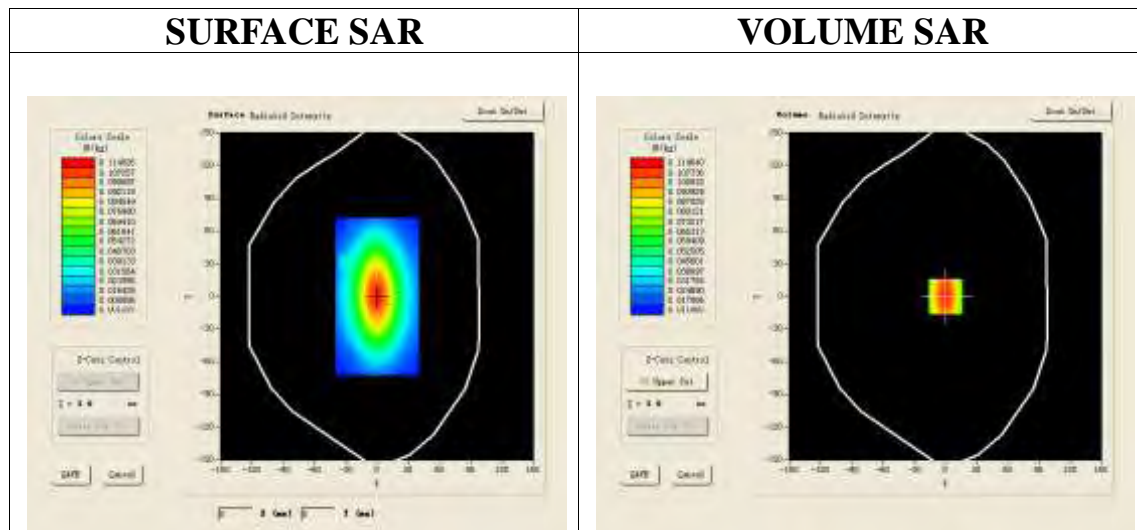

**Maximum location: X=0.00, Y=0.00**

<b>SAR 10g (W/Kg)</b>	0.066620
<b>SAR 1g (W/Kg)</b>	0.104071

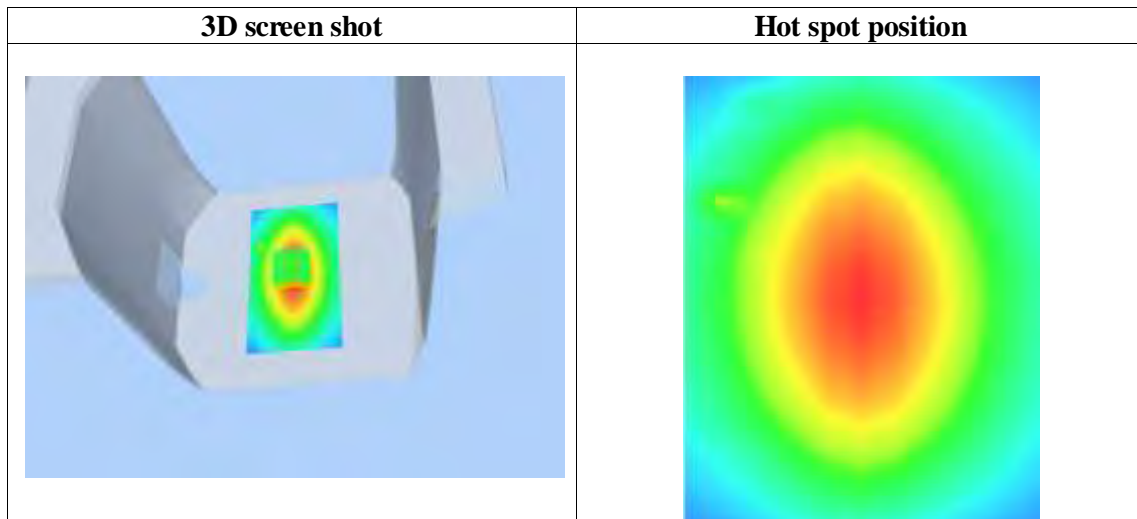
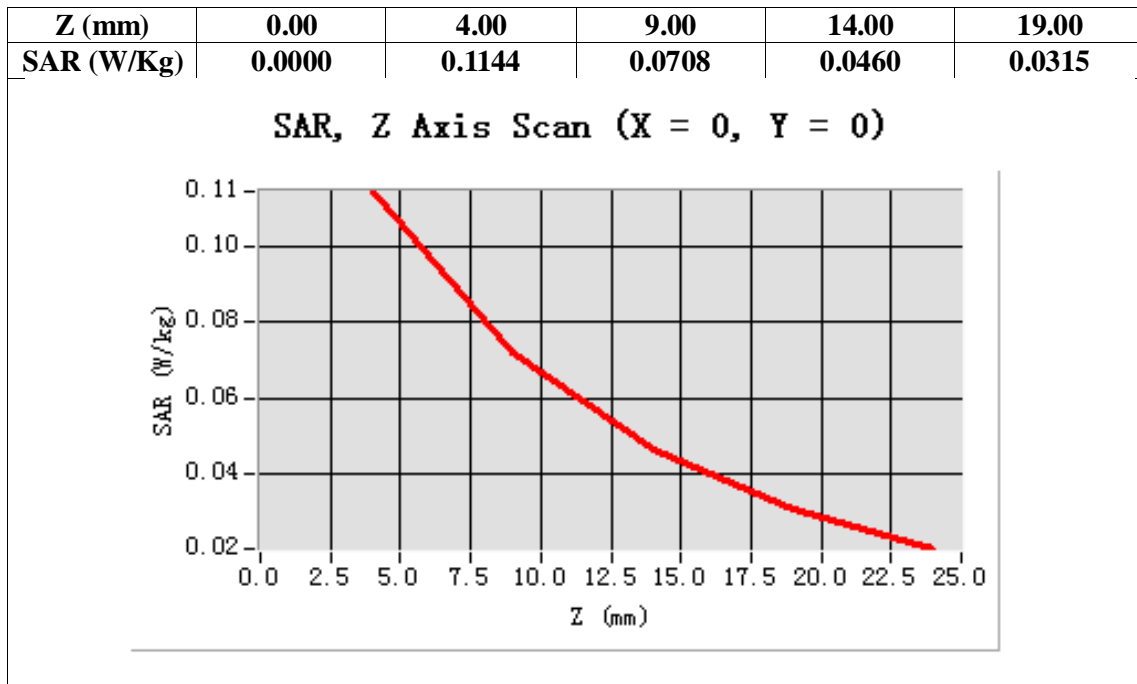

**Test Laboratory: AGC Lab**  
**System Check Body 835 MHz**  
**DUT: Dipole 900 MHz Type: SID 900**

**Date: July 24,2014**

Communication System CW; Communication System Band: D835 (835.0 MHz); Duty Cycle: 1:1; Conv.F=5.48  
Frequency: 835 MHz; Medium parameters used:  $f = 835$  MHz;  $\sigma=0.96$  mho/m;  $\epsilon_r =55.76$ ;  $\rho= 1000$  kg/m<sup>3</sup> ;  
Phantom section: Flat Section; Input Power=10dBm  
Ambient temperature (°C): 21, Liquid temperature (°C): 21

SATIMO Configuration:

- Probe: SSE5; Calibrated: 01/12/2014; Serial No.:SN 22/12 EP159
- Sensor-Surface: 4mm (Mechanical Surface Detection)
- Phantom: Flat Phantom; Type: Elliptical Phantom
- Measurement SW: OpenSAR V4\_02\_01

**Configuration/System Check GSM 835 Body/Area Scan: Measurement grid: dx=8mm, dy=8mm**  
**Configuration/System Check GSM 835 Body/Zoom Scan: Measurement grid: dx=8mm, dy=8mm, dz=5mm**

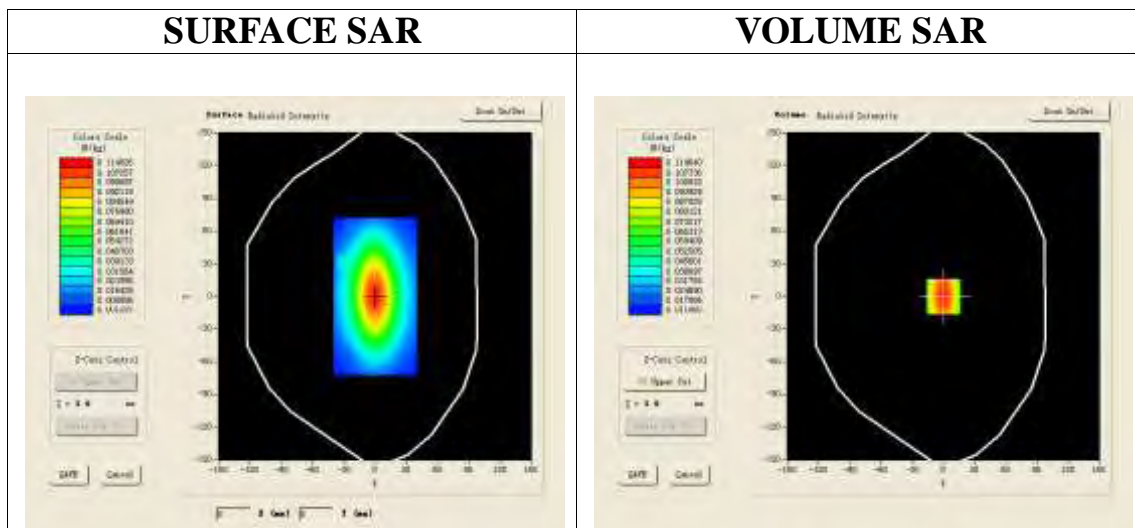

**Maximum location: X=0.00, Y=0.00**

<b>SAR 10g (W/Kg)</b>	0.068849
<b>SAR 1g (W/Kg)</b>	0.107053

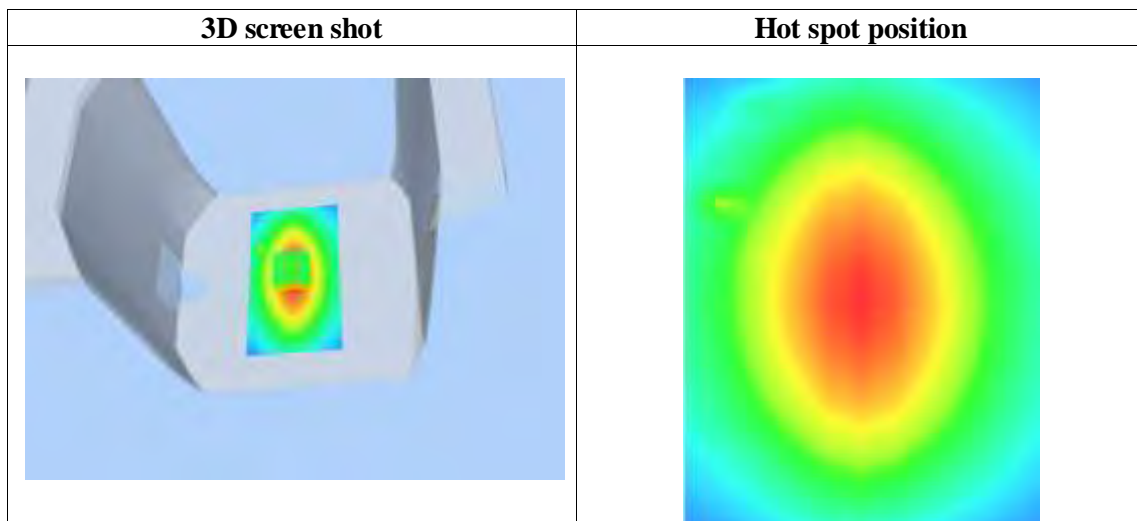
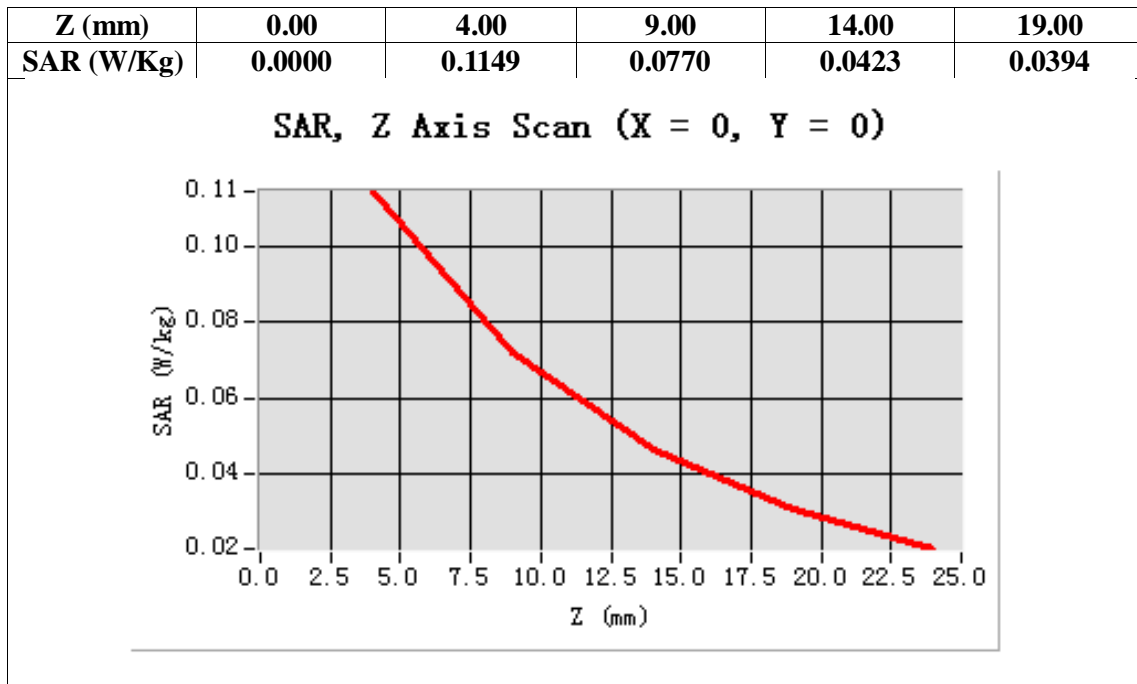



Test Laboratory: AGC Lab  
System Check Head 1700MHz

Date: July 24,2014

DUT: Dipole 1700 MHz; Type: SID 1800

Communication System: CW; Communication System Band: D1700 (1700.0 MHz); Duty Cycle:1:1; Conv.F=4.58  
Frequency: 1732.6 MHz; Medium parameters used:  $f = 1700\text{MHz}$ ;  $\sigma=1.38\text{ mho/m}$ ;  $\epsilon_r=40.16$ ;  $\rho= 1000\text{ kg/m}^3$  ;  
Phantom section: Flat Section; Input Power=10dBm  
Ambient temperature ( $^{\circ}\text{C}$ ): 21, Liquid temperature ( $^{\circ}\text{C}$ ): 21

SATIMO Configuration:

- Probe: SSE5; Calibrated: 01/12/2014; Serial No.:SN 22/12 EP159
- Sensor-Surface: 4mm (Mechanical Surface Detection)
- Phantom: Flat Phantom; Type: Elliptical Phantom
- Measurement SW: OpenSAR V4\_02\_01

Configuration/System Check PCS1700 Head/Area Scan: Measurement grid:  $dx=8\text{mm}, dy=8\text{mm}$

Configuration/System Check PCS1700 Head/Zoom Scan: Measurement grid:  $dx=8\text{mm}, dy=8\text{mm}, dz=5\text{mm}$

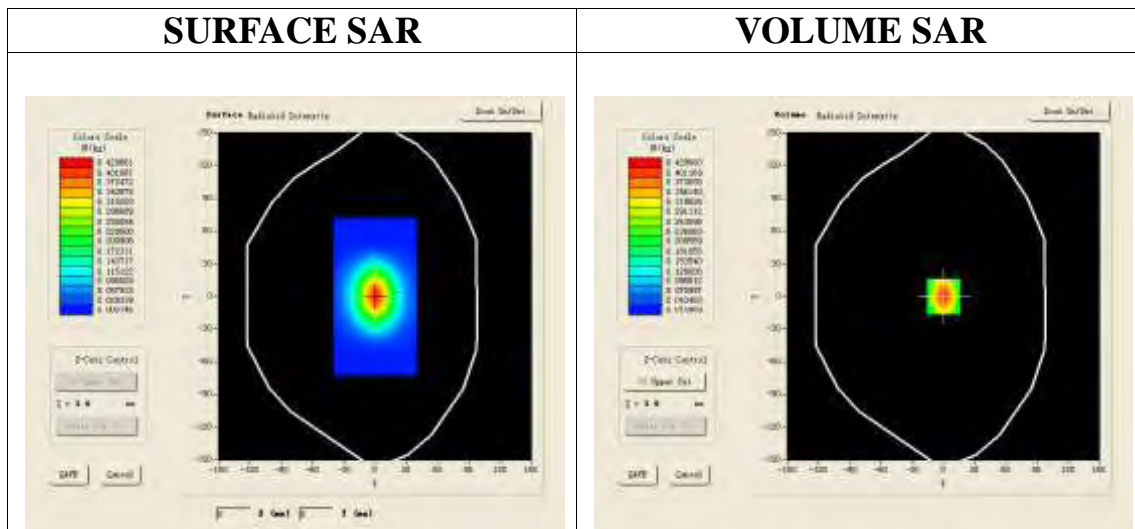

**Maximum location: X=0.00, Y=0.00**

<b>SAR 10g (W/Kg)</b>	0.202130
<b>SAR 1g (W/Kg)</b>	0.385140

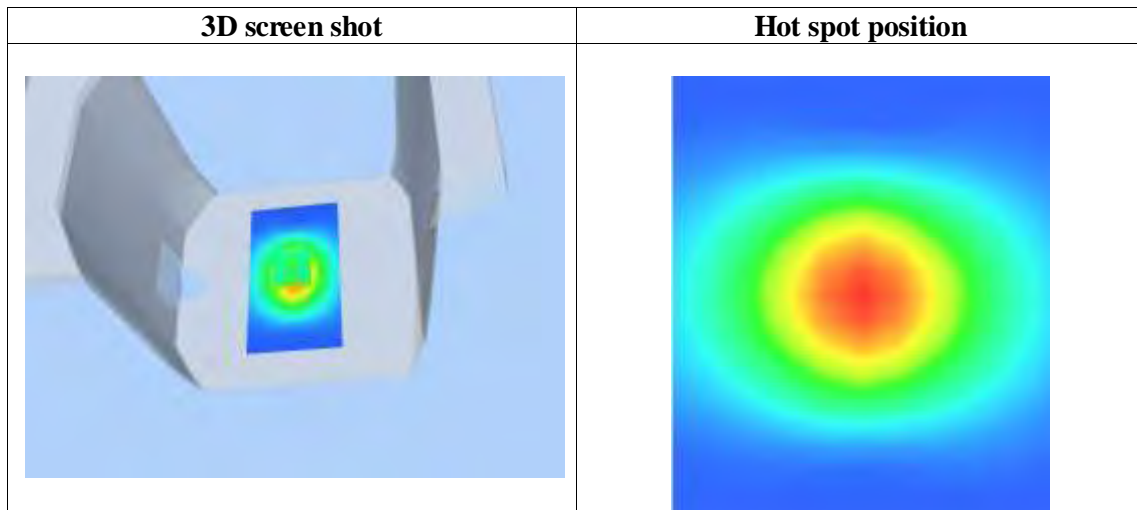
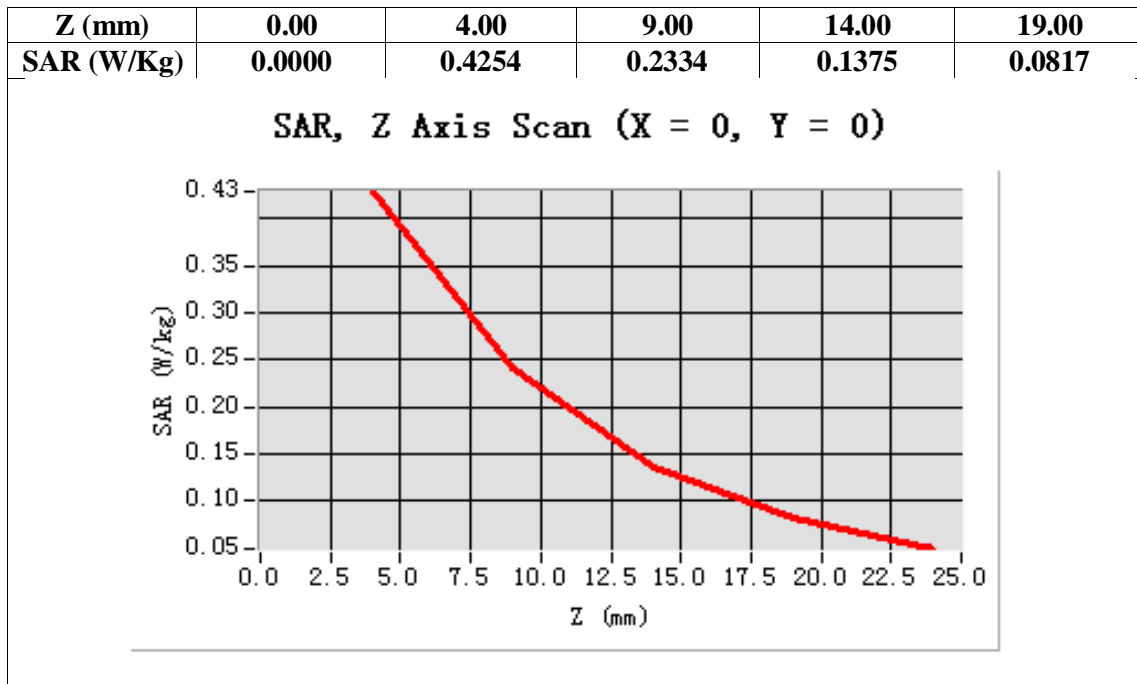

**Test Laboratory: AGC Lab**  
**System Check Body 1700MHz**  
**DUT: Dipole 1700 MHz; Type: SID 1800**

**Date: July 24,2014**

Communication System: CW; Communication System Band: D1700 (1700.0 MHz); Duty Cycle:1:1; Conv.F=4.71  
Frequency: 1732.6 MHz; Medium parameters used:  $f = 1700\text{MHz}$ ;  $\sigma=1.50\text{ mho/m}$ ;  $\epsilon_r=53.17$ ;  $\rho= 1000\text{ kg/m}^3$  ;  
Phantom section: Flat Section; Input Power=10dBm  
Ambient temperature ( $^{\circ}\text{C}$ ): 21, Liquid temperature ( $^{\circ}\text{C}$ ): 21

SATIMO Configuration:

- Probe: SSE5; Calibrated: 01/12/2014; Serial No.:SN 22/12 EP159
- Sensor-Surface: 4mm (Mechanical Surface Detection)
- Phantom: Flat Phantom; Type: Elliptical Phantom
- Measurement SW: OpenSAR V4\_02\_01

**Configuration/System Check PCS 1700 Body/Area Scan: Measurement grid: dx=8mm,dy=8mm**  
**Configuration/System Check PCS 1700 Body/Zoom Scan: Measurement grid: dx=8mm, dy=8mm, dz=5mm**

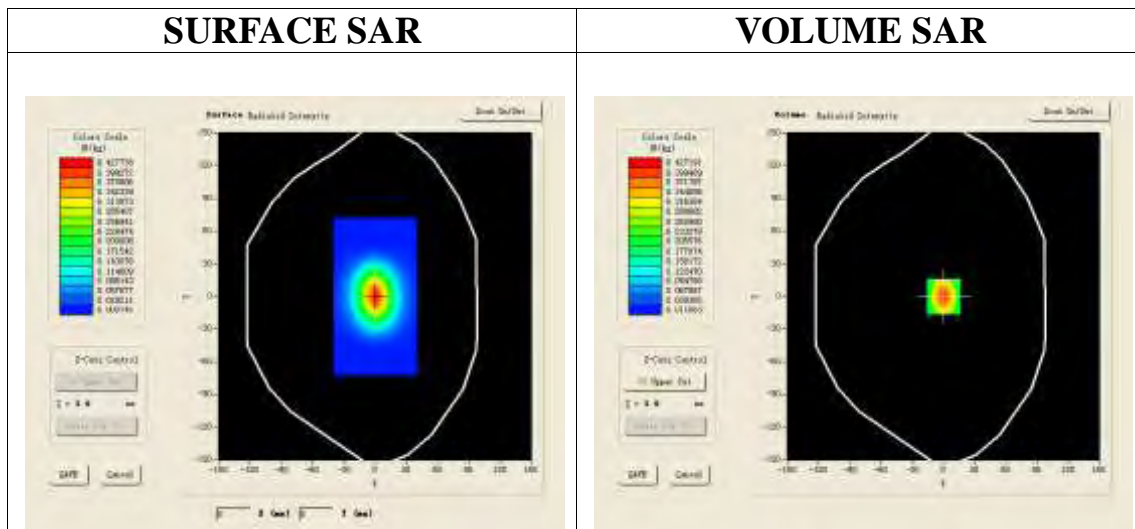

**Maximum location: X=0.00, Y=0.00**

<b>SAR 10g (W/Kg)</b>	0.204170
<b>SAR 1g (W/Kg)</b>	0.399017

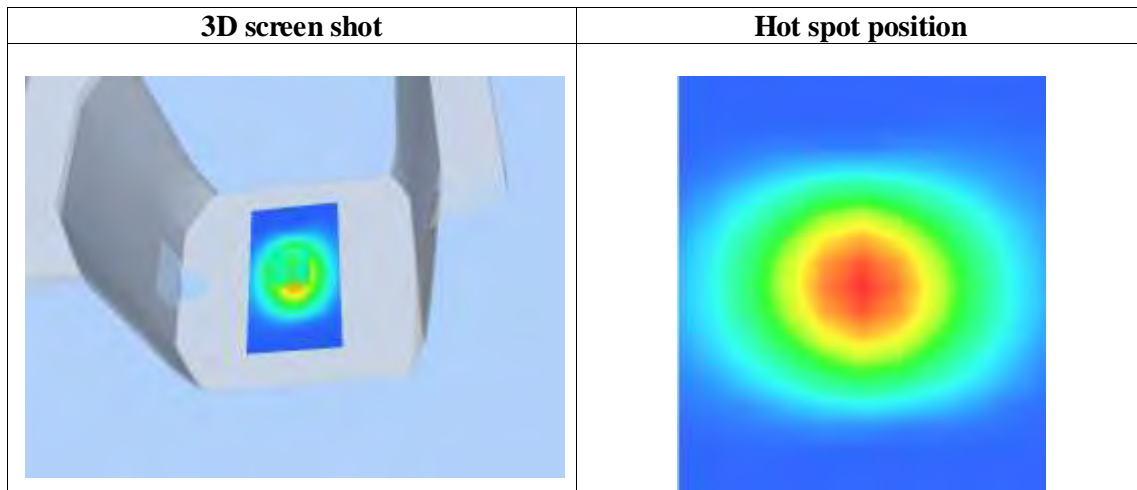
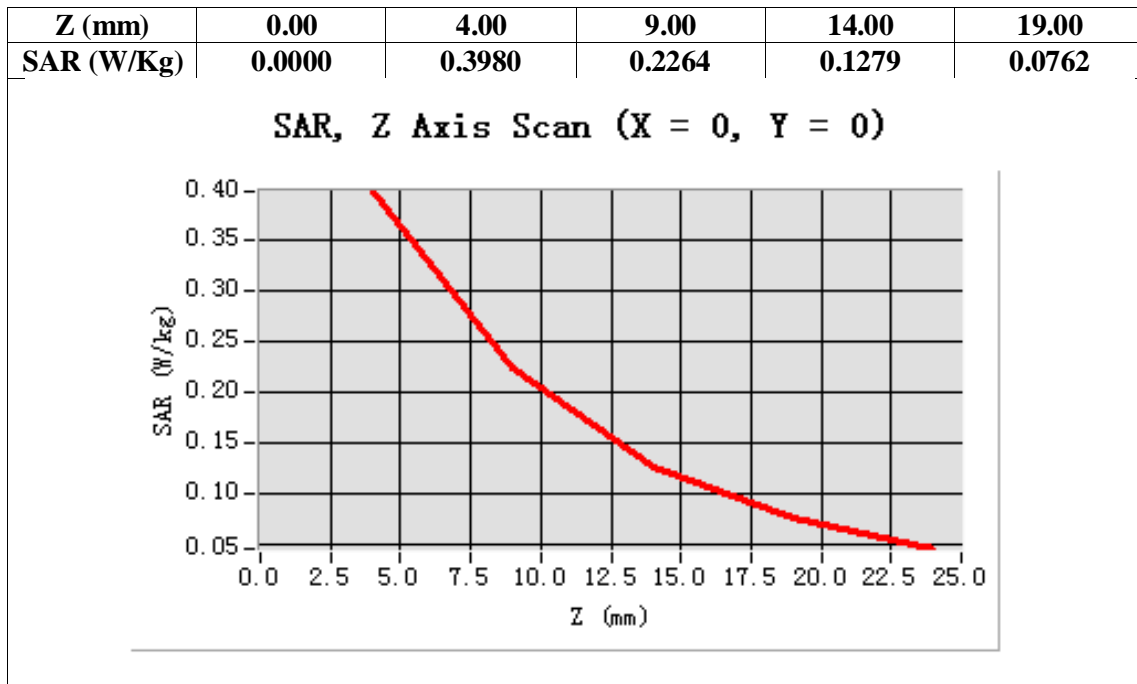

Test Laboratory: AGC Lab  
System Check Head 1900MHz

Date: July 24,2014

DUT: Dipole 1900 MHz; Type: SID 1900

Communication System: CW; Communication System Band: D1900 (1900.0 MHz); Duty Cycle:1:1; Conv.F=4.51  
Frequency: 1900 MHz; Medium parameters used:  $f = 1900$  MHz;  $\sigma=1.42$  mho/m;  $\epsilon_r =40.41$ ;  $\rho= 1000$  kg/m<sup>3</sup> ;  
Phantom section: Flat Section; Input Power=10dBm  
Ambient temperature (°C): 21, Liquid temperature (°C): 21

SATIMO Configuration:

- Probe: SSE5; Calibrated: 01/12/2014; Serial No.:SN 22/12 EP159
- Sensor-Surface: 4mm (Mechanical Surface Detection)
- Phantom: Flat Phantom; Type: Elliptical Phantom
- Measurement SW: OpenSAR V4\_02\_01

Configuration/System Check PCS1900 Head/Area Scan: Measurement grid: dx=8mm,dy=8mm

Configuration/System Check PCS1900 Head/Zoom Scan: Measurement grid: dx=8mm,  
dy=8mm, dz=5mm

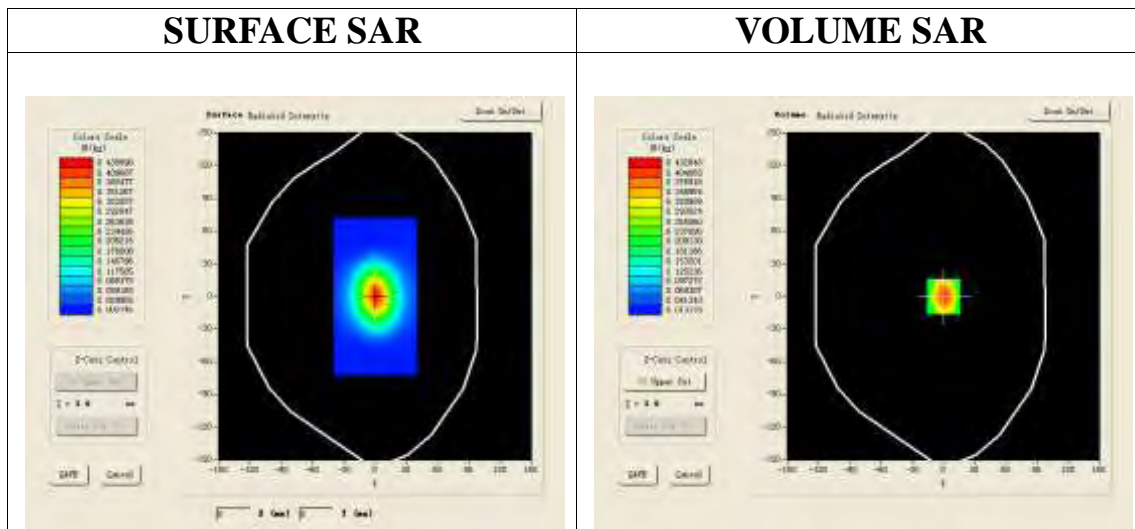

**Maximum location: X=0.00, Y=0.00**

<b>SAR 10g (W/Kg)</b>	0.202882
<b>SAR 1g (W/Kg)</b>	0.403185

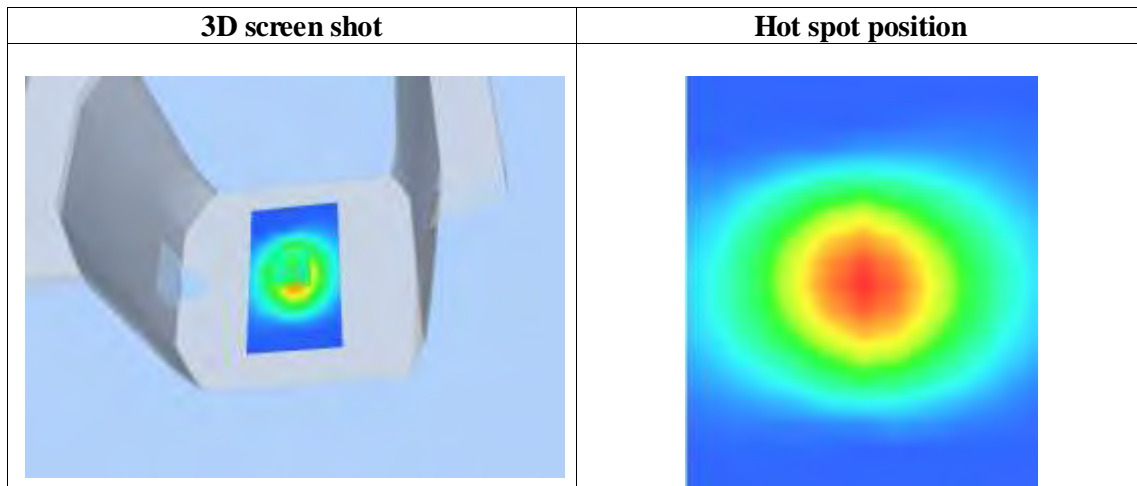
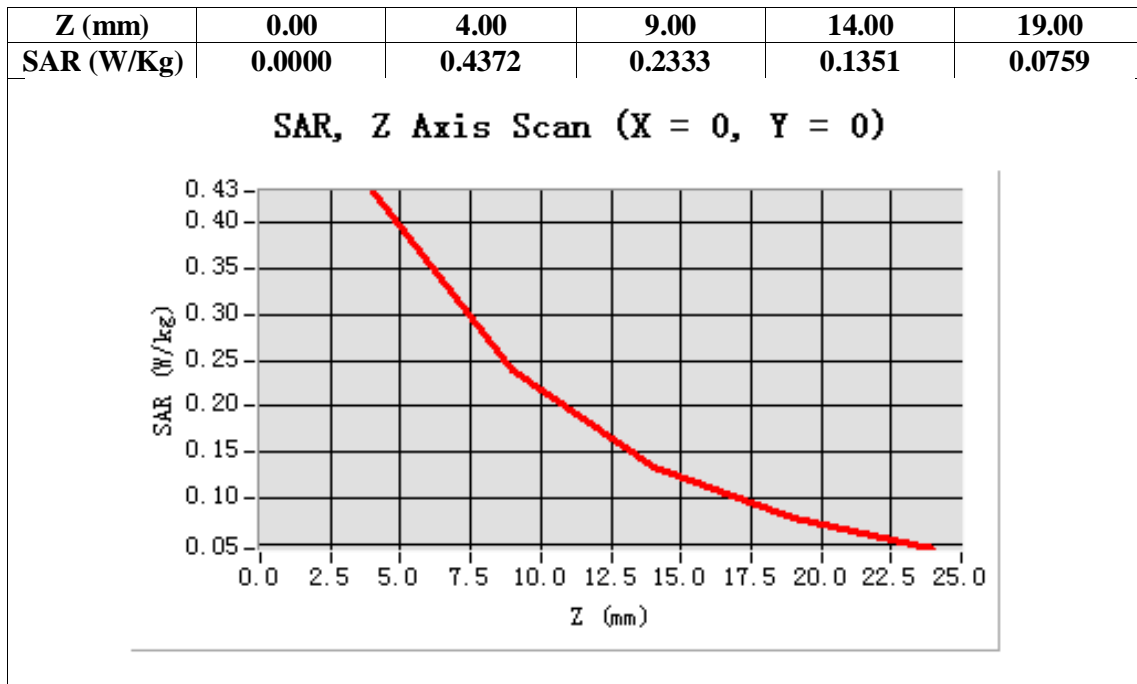

Test Laboratory: AGC Lab  
System Check Body 1900MHz

Date: July 24,2014

DUT: Dipole 1900 MHz; Type: SID 1900

Communication System: CW; Communication System Band: D1900 (1900.0 MHz); Duty Cycle:1:1; Conv.F=4.45  
Frequency: 1900 MHz; Medium parameters used:  $f = 1900$  MHz;  $\sigma=1.53$  mho/m;  $\epsilon_r=53.79$ ;  $\rho= 1000$  kg/m<sup>3</sup> ;  
Phantom section: Flat Section; Input Power=10dBm  
Ambient temperature (°C): 21, Liquid temperature (°C): 21

SATIMO Configuration:

- Probe: SSE5; Calibrated: 01/12/2014; Serial No.:SN 22/12 EP159
- Sensor-Surface: 4mm (Mechanical Surface Detection)
- Phantom: Flat Phantom; Type: Elliptical Phantom
- Measurement SW: OpenSAR V4\_02\_01

Configuration/System Check PCS1900 Body/Area Scan: Measurement grid: dx=8mm,dy=8mm

Configuration/System Check PCS1900 Body/Zoom Scan: Measurement grid: dx=8mm, dy=8mm, dz=5mm

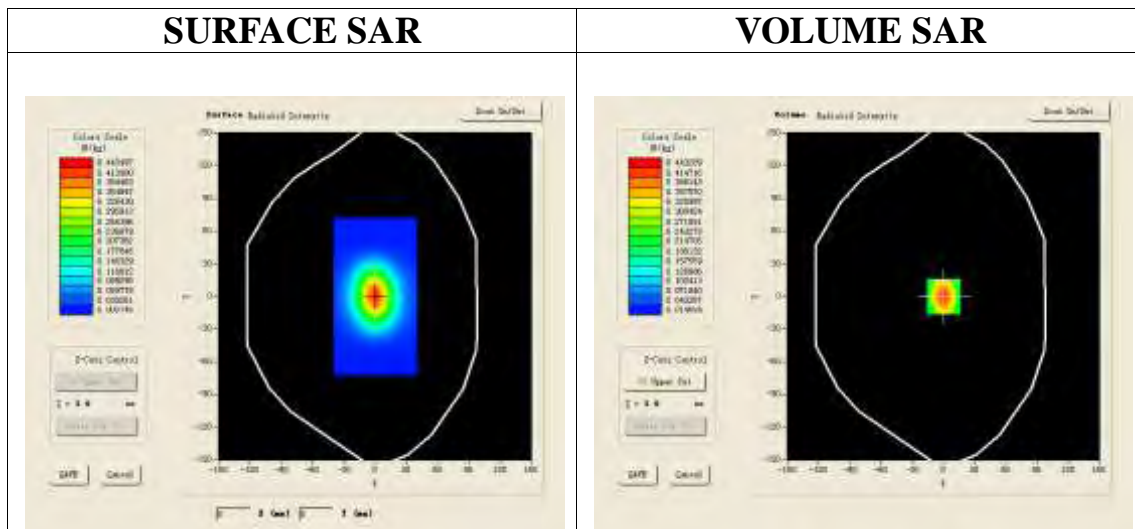

**Maximum location: X=0.00, Y=0.00**

<b>SAR 10g (W/Kg)</b>	0.211470
<b>SAR 1g (W/Kg)</b>	0.408762

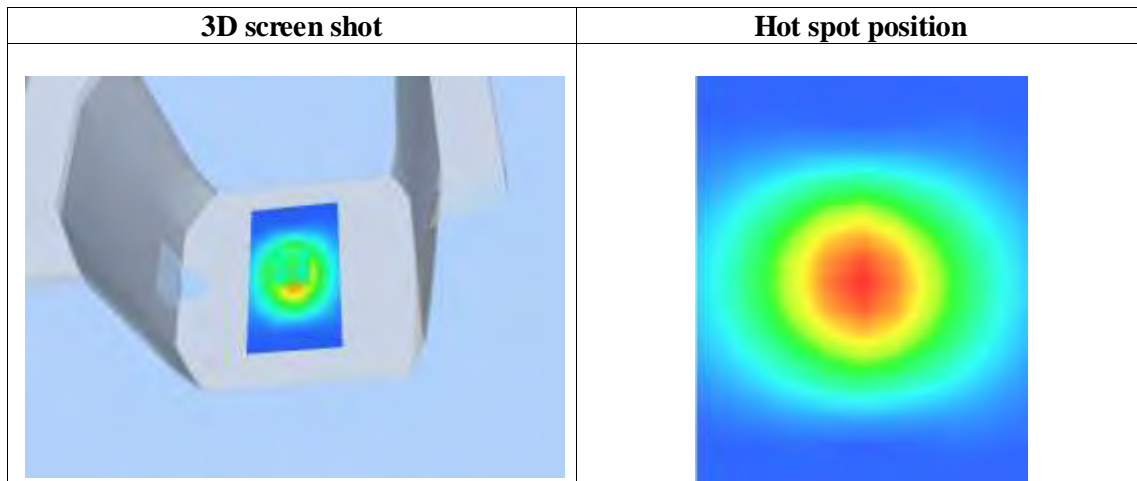
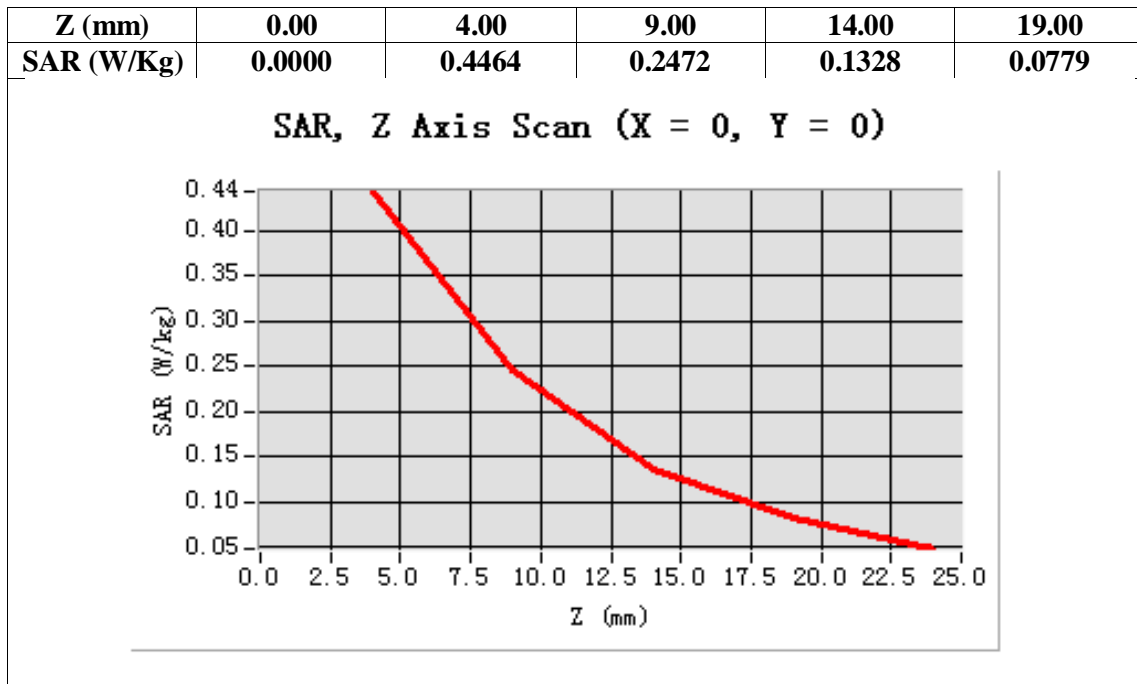



**Test Laboratory: AGC Lab**  
**System Check Head 2450 MHz**  
**DUT: Dipole 2450 MHz Type: SID 2450**

**Date: July 24,2014**

Communication System: CW; Communication System Band: D2450 (2450.0 MHz); Duty Cycle: 1:1; Conv.F=4.42  
Frequency: 2450 MHz; Medium parameters used:  $f = 2450$  MHz;  $\sigma = 1.82$  mho/m;  $\epsilon_r = 39.46$ ;  $\rho = 1000$  kg/m<sup>3</sup> ;  
Phantom section: Flat Section; Input Power=10dBm  
Ambient temperature (°C): 21, Liquid temperature (°C): 21

SATIMO Configuration:

- Probe: SSE5; Calibrated: 01/12/2014; Serial No.:SN 22/12 EP159
- Sensor-Surface: 4mm (Mechanical Surface Detection)
- Phantom: Flat Phantom; Type: Elliptical Phantom
- Measurement SW: OpenSAR V4\_02\_01

**Configuration/System Check 2450 MHz Head/Area Scan: Measurement grid: dx=8mm,dy=8mm**

**Configuration/System Check 2450 MHz Head/Zoom Scan: Measurement grid: dx=8mm, dy=8mm, dz=5mm**

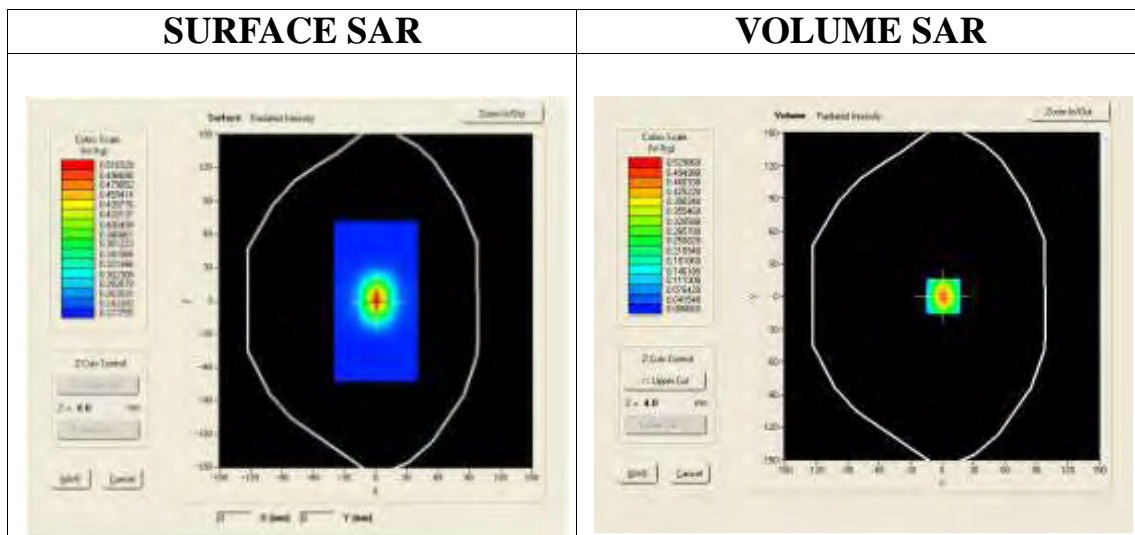

**Maximum location: X=1.00, Y=0.00**

<b>SAR 10g (W/Kg)</b>	0.233180
<b>SAR 1g (W/Kg)</b>	0.499731

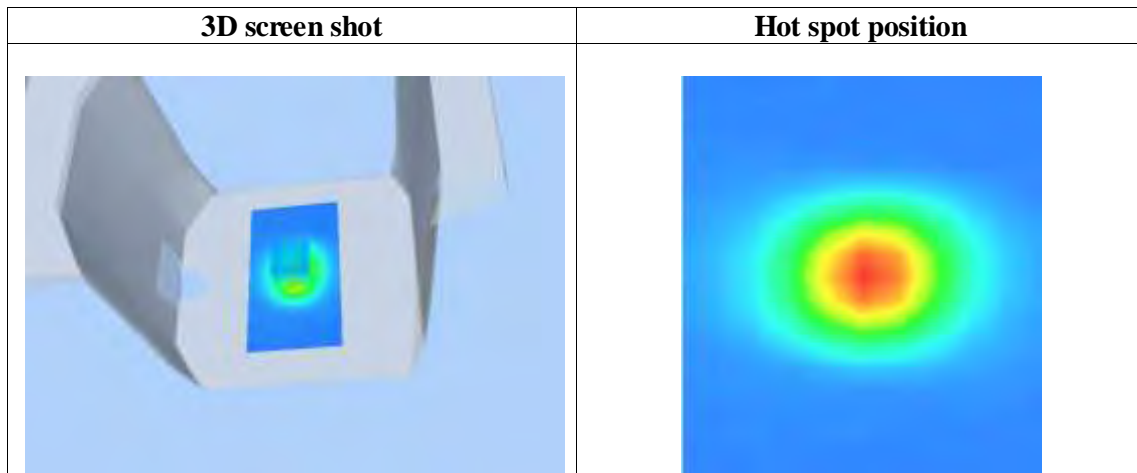
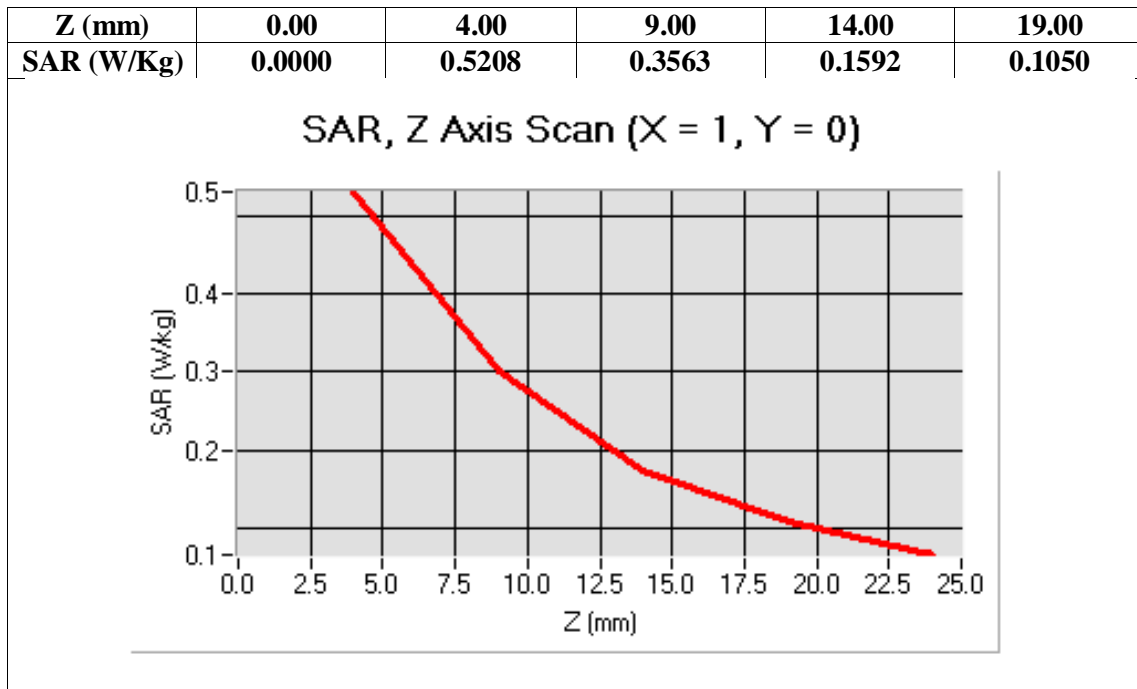

**Test Laboratory: AGC Lab**  
**System Check Body 2450 MHz**  
**DUT: Dipole 2450 MHz Type: SID 2450**

**Date: July 24,2014**

Communication System: CW; Communication System Band: D2450 (2450.0 MHz); Duty Cycle: 1:1; Conv.F=4.31  
Frequency: 2450 MHz; Medium parameters used:  $f = 2450$  MHz;  $\sigma = 1.87$  mho/m;  $\epsilon_r = 52.55$ ;  $\rho = 1000$  kg/m<sup>3</sup> ;  
Phantom section: Flat Section; Input Power=10dBm  
Ambient temperature (°C): 21, Liquid temperature (°C): 21

SATIMO Configuration:

- Probe: SSE5; Calibrated: 01/12/2014; Serial No.:SN 22/12 EP159
- Sensor-Surface: 4mm (Mechanical Surface Detection)
- Phantom: Flat Phantom; Type: Elliptical Phantom
- Measurement SW: OpenSAR V4\_02\_01

**Configuration/System Check 2450 MHz Body/Area Scan: Measurement grid: dx=8mm,dy=8mm**

**Configuration/System Check 2450 MHz Body/Zoom Scan: Measurement grid: dx=8mm, dy=8mm, dz=5mm**

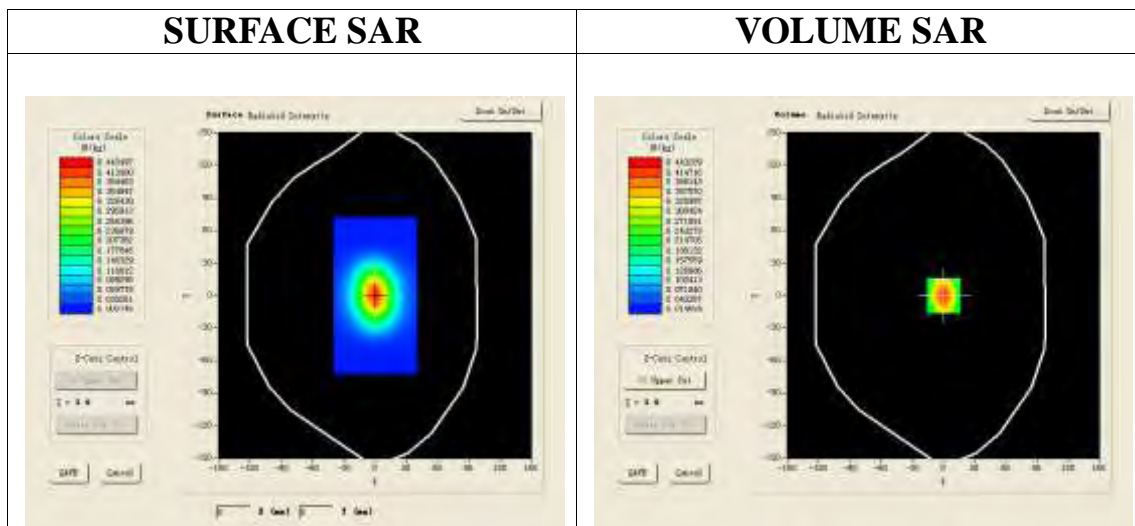

**Maximum location: X=0.00, Y=0.00**

<b>SAR 10g (W/Kg)</b>	0.242274
<b>SAR 1g (W/Kg)</b>	0.498346

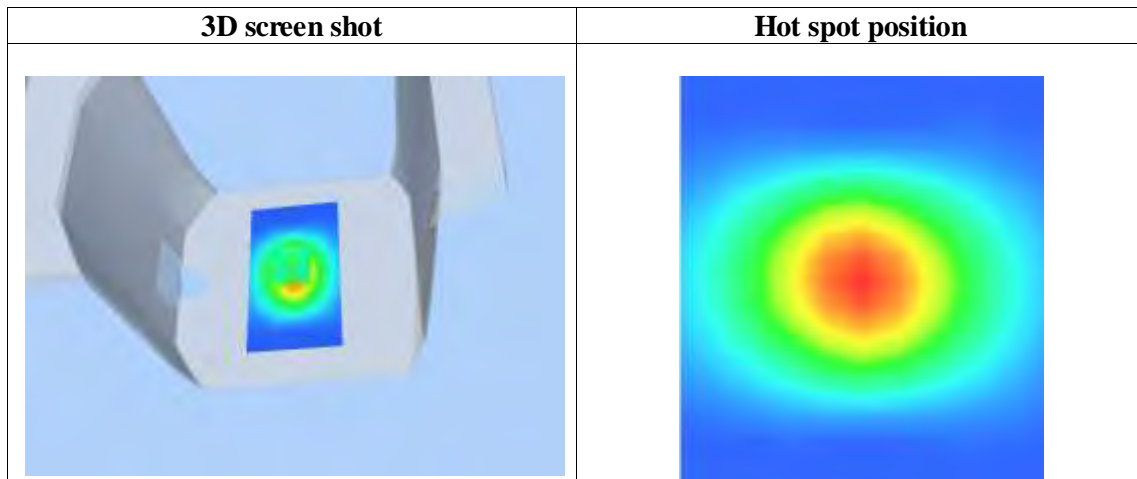
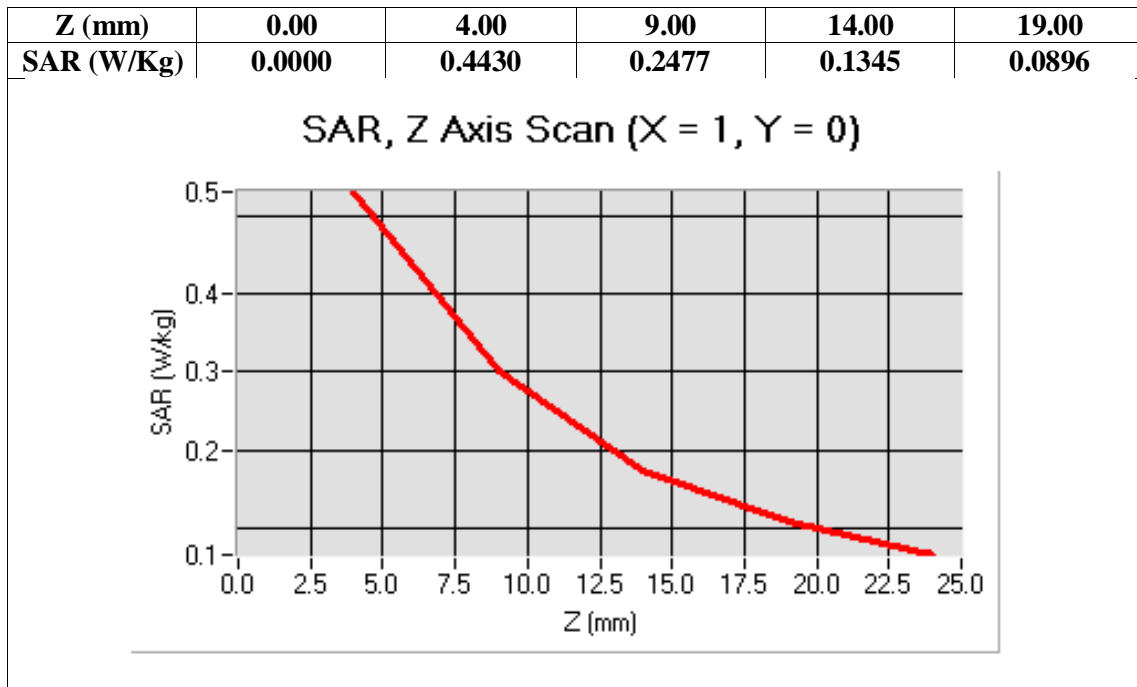

## APPENDIX B. SAR MEASUREMENT DATA

Test Laboratory: AGC Lab  
GSM 835 Mid-Touch-Left <SIM 1>  
DUT: Mobile Phone; Type: QUE 5.0

Date: July 24,2014

Communication System: Generic GSM; Communication System Band: GSM 835; Duty Cycle: 1:8.3; Conv.F=5.27  
Frequency: 836.6 MHz; Medium parameters used:  $f = 835$  MHz;  $\sigma=0.88$  mho/m;  $\epsilon_r=41.91$ ;  $\rho= 1000$  kg/m<sup>3</sup> ;  
Phantom section: Left Section  
Ambient temperature (°C): 21.0, Liquid temperature (°C): 21.0

SATIMO Configuration:

- Probe: SSE5; Calibrated: 01/12/2014; Serial No.:SN 22/12 EP159
- Sensor-Surface: 4mm (Mechanical Surface Detection)
- Phantom: Flat Phantom; Type: Elliptical Phantom
- Measurement SW: OpenSAR V4\_02\_01

Configuration/GSM 835 Mid-Touch-Left/Area Scan (6x8x1): Measurement grid: dx=8mm, dy=8mm  
Configuration/GSM 835 Mid-Touch-Left/Zoom Scan (5x5x7)/Cube 0: Measurement grid: dx=8mm, dy=8mm, dz=5mm

Area Scan	sam_direct_droit2_surf8mm.txt
ZoomScan	5x5x7,dx=8mm dy=8mm dz=5mm,Very fast
Phantom	Left head
Device Position	Cheek
Band	GSM 835
Channels	Middle
Signal	TDMA (Crest factor: 8.0)

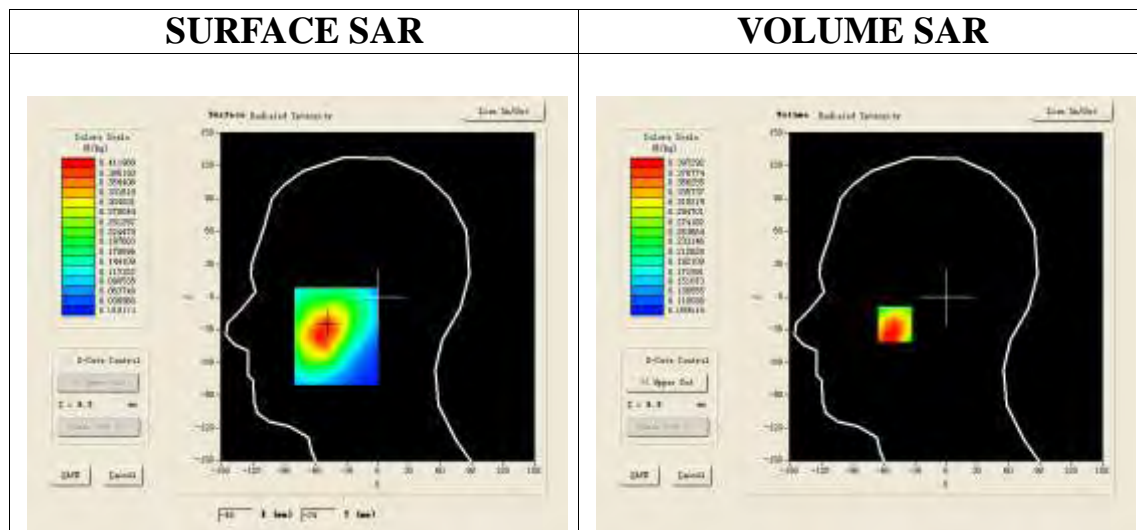

Maximum location: X=-49.00, Y=-25.00

SAR 10g (W/Kg)	0.295368
SAR 1g (W/Kg)	0.384217

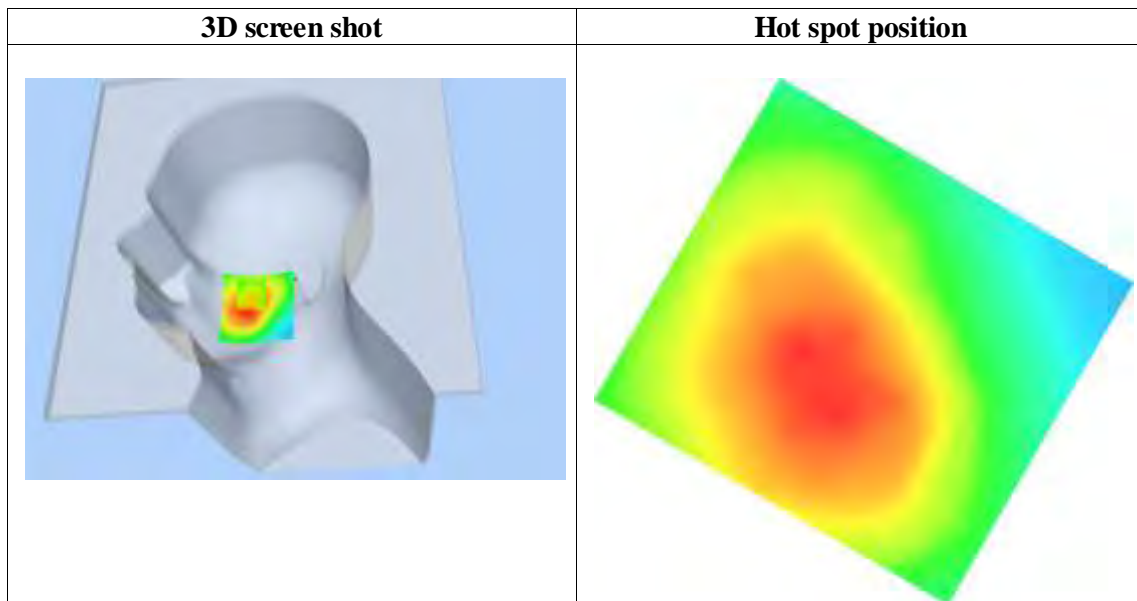
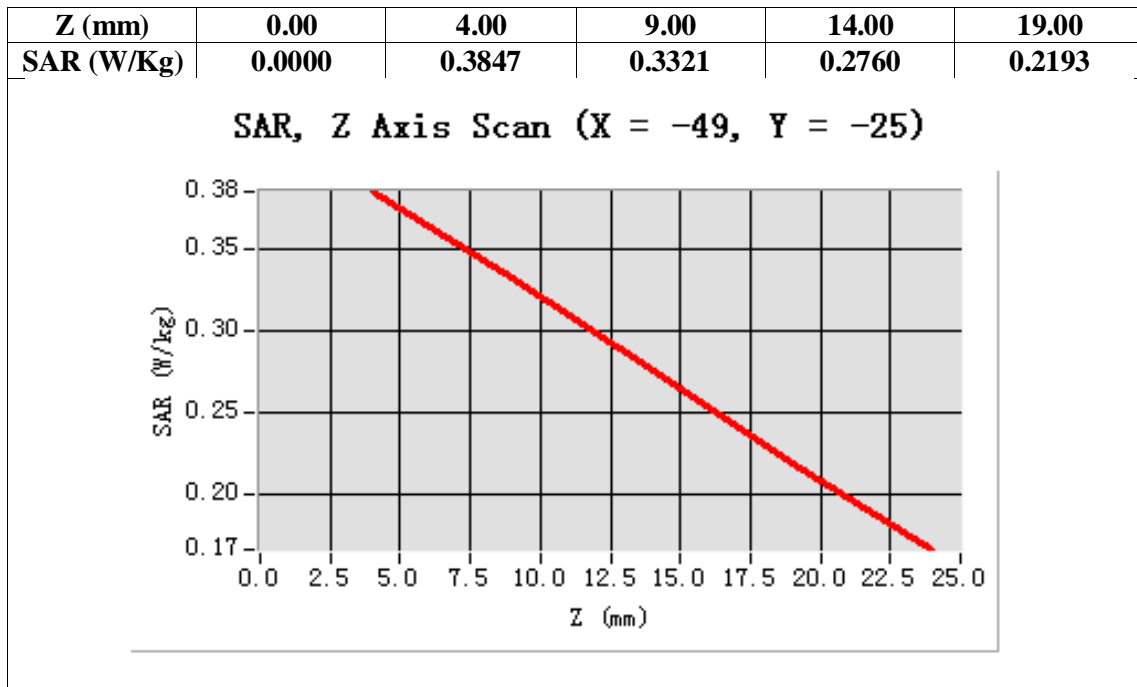

Test Laboratory: AGC Lab  
GSM 835 Mid-Tilt-Left <SIM 1>  
DUT: Mobile Phone; Type: QUE 5.0

Date: July 24,2014

Communication System: Generic GSM; Communication System Band: GSM 835; Duty Cycle: 1:8.3; Conv.F=5.27;  
Frequency: 836.6 MHz; Medium parameters used: f = 835 MHz;  $\sigma=0.88$  mho/m;  $\epsilon_r=41.91$  ;  $\rho= 1000$  kg/m<sup>3</sup> ;  
Phantom section: Left Section  
Ambient temperature (°C): 21.0, Liquid temperature(°C): 21.0

SATIMO Configuration:

- Probe: SSE5; Calibrated: 01/12/2014; Serial No.:SN 22/12 EP159
- Sensor-Surface: 4mm (Mechanical Surface Detection)
- Phantom: Flat Phantom; Type: Elliptical Phantom
- Measurement SW: OpenSAR V4\_02\_01

Configuration/GSM 835 Mid-Tilt-Left/Area Scan (6x8x1): Measurement grid: dx=8mm, dy=8mm  
Configuration/GSM 835 Mid-Tilt-Left/Zoom Scan (5x5x7)/Cube 0: Measurement grid: dx=8mm, dy=8mm,dz=5mm;

<b>Area Scan</b>	sam_direct_droit2_surf8mm.txt
<b>ZoomScan</b>	5x5x7,dx=8mm dy=8mm dz=5mm,Very fast
<b>Phantom</b>	Left head
<b>Device Position</b>	Tilt
<b>Band</b>	GSM 835
<b>Channels</b>	Middle
<b>Signal</b>	TDMA (Crest factor: 8.0)

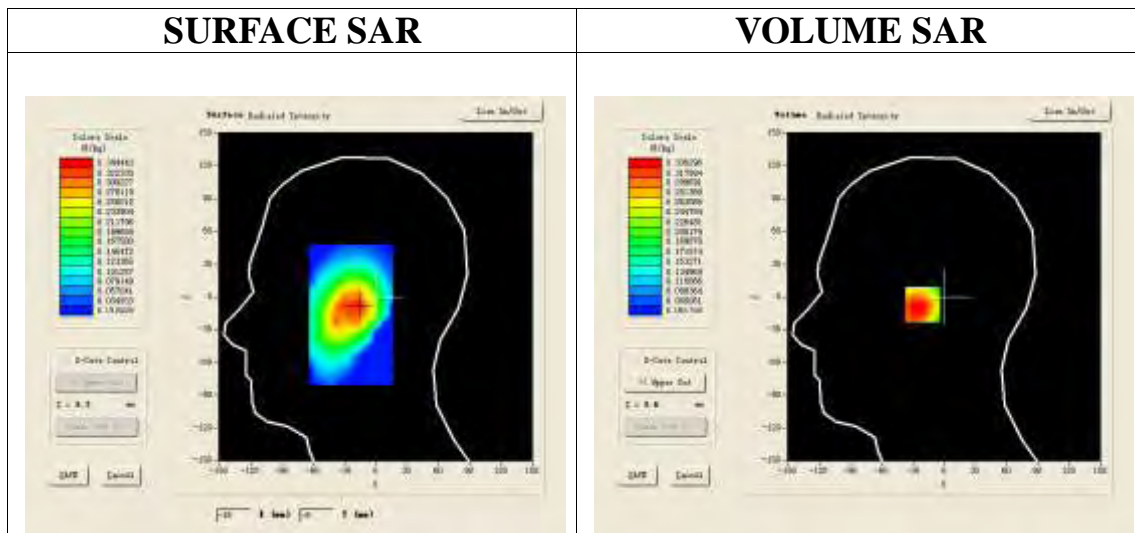

**Maximum location: X=-17.00, Y=-7.00**

<b>SAR 10g (W/Kg)</b>	0.245873
<b>SAR 1g (W/Kg)</b>	0.325437

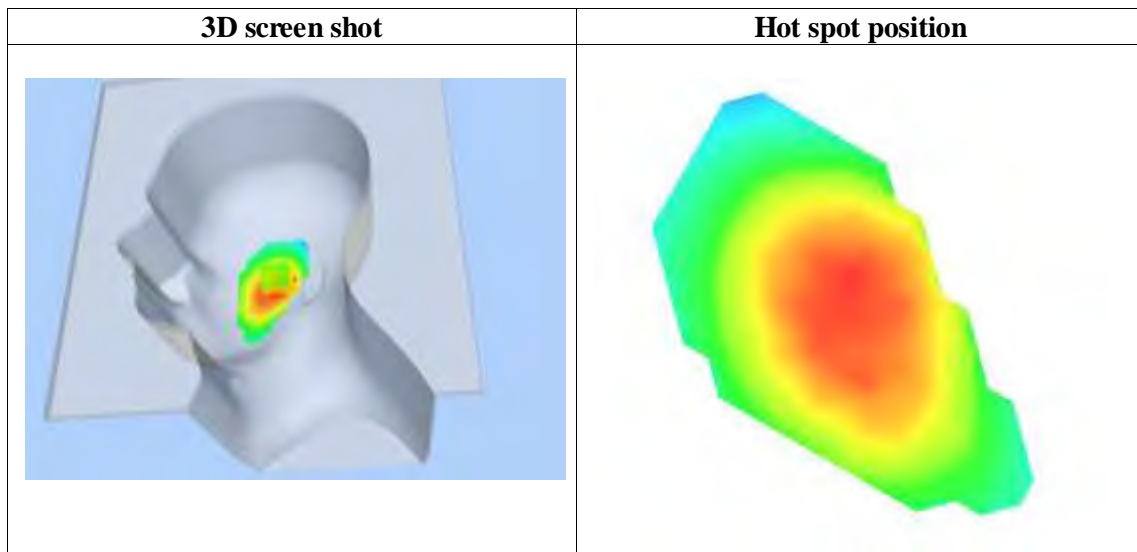
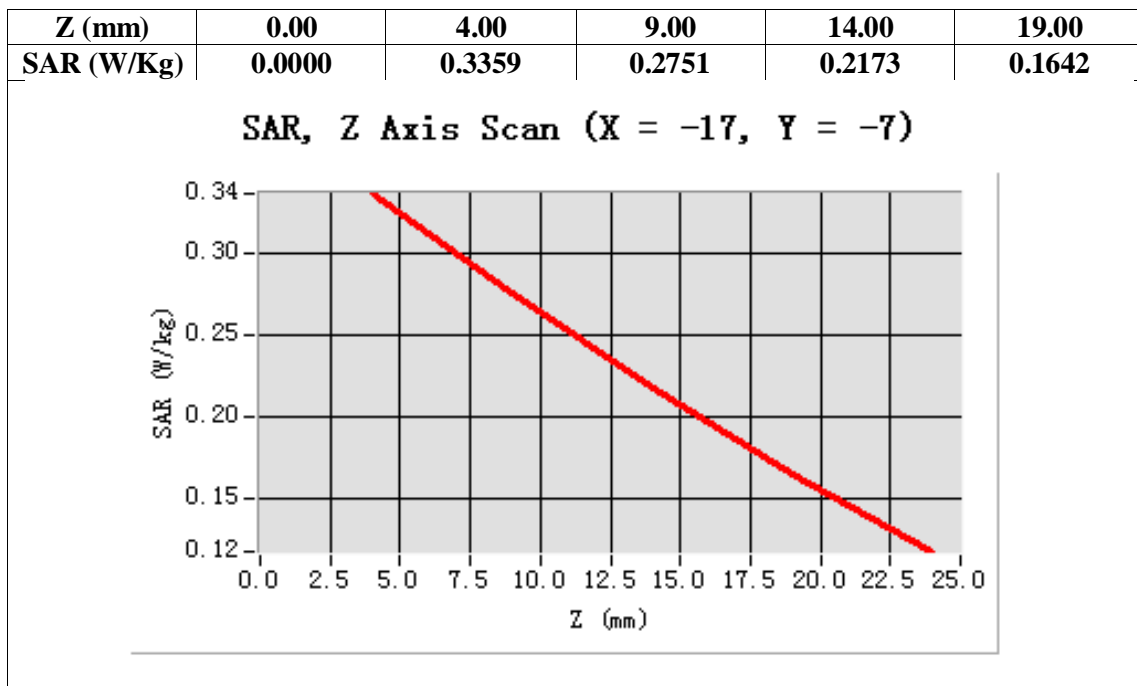



Test Laboratory: AGC Lab  
GSM 835 Mid-Touch-Right <SIM 1>  
DUT: Mobile Phone; Type: QUE 5.0

Date: July 24,2014

Communication System: Generic GSM; Communication System Band: GSM 835; Duty Cycle: 1:8.3; Conv.F=5.27;  
Frequency: 836.6 MHz; Medium parameters used: f = 835 MHz;  $\sigma = 0.88$  mho/m;  $\epsilon_r = 41.91$ ;  $\rho = 1000$  kg/m<sup>3</sup> ;  
Phantom section: Right Section  
Ambient temperature (°C): 21.0, Liquid temperature (°C): 21.0

SATIMO Configuration:

- Probe: SSE5; Calibrated: 01/12/2014; Serial No.:SN 22/12 EP159
- Sensor-Surface: 4mm (Mechanical Surface Detection)
- Phantom: Flat Phantom; Type: Elliptical Phantom
- Measurement SW: OpenSAR V4\_02\_01

Configuration/GSM 835 Mid-Touch-Right/Area Scan: Measurement grid: dx=8mm, dy=8mm  
Configuration/GSM 835 Mid-Touch-Right/Zoom Scan: Measurement grid: dx=8mm, dy=8mm, dz=5mm;

<b>Area Scan</b>	sam_direct_droit2_surf8mm.txt
<b>ZoomScan</b>	5x5x7,dx=8mm dy=8mm dz=5mm,Very fast
<b>Phantom</b>	Right head
<b>Device Position</b>	Cheek
<b>Band</b>	GSM 835
<b>Channels</b>	Middle
<b>Signal</b>	TDMA (Crest factor: 8.0)

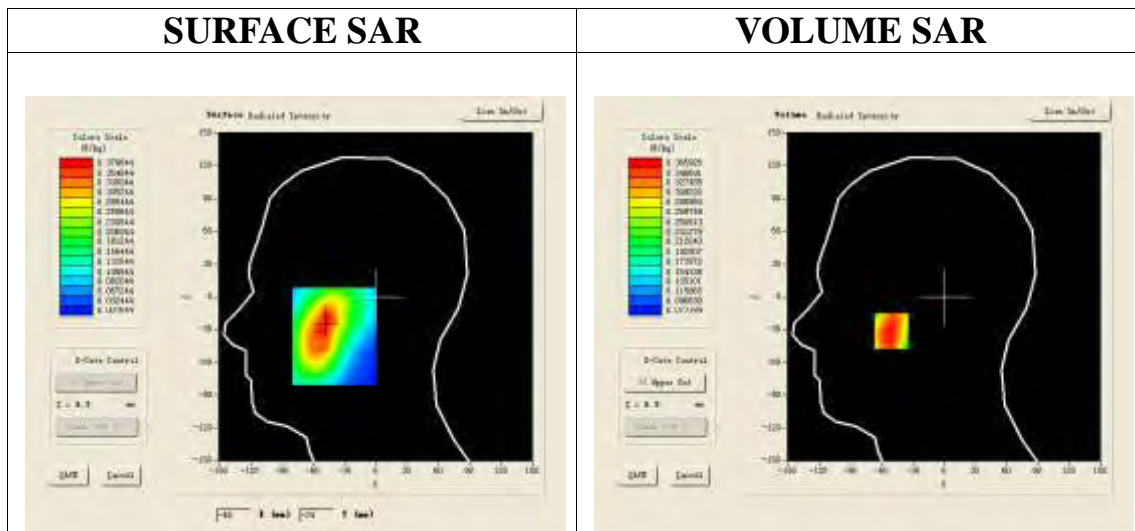

Maximum location: X=-51.00, Y=-31.00

<b>SAR 10g (W/Kg)</b>	0.251795
<b>SAR 1g (W/Kg)</b>	0.353216

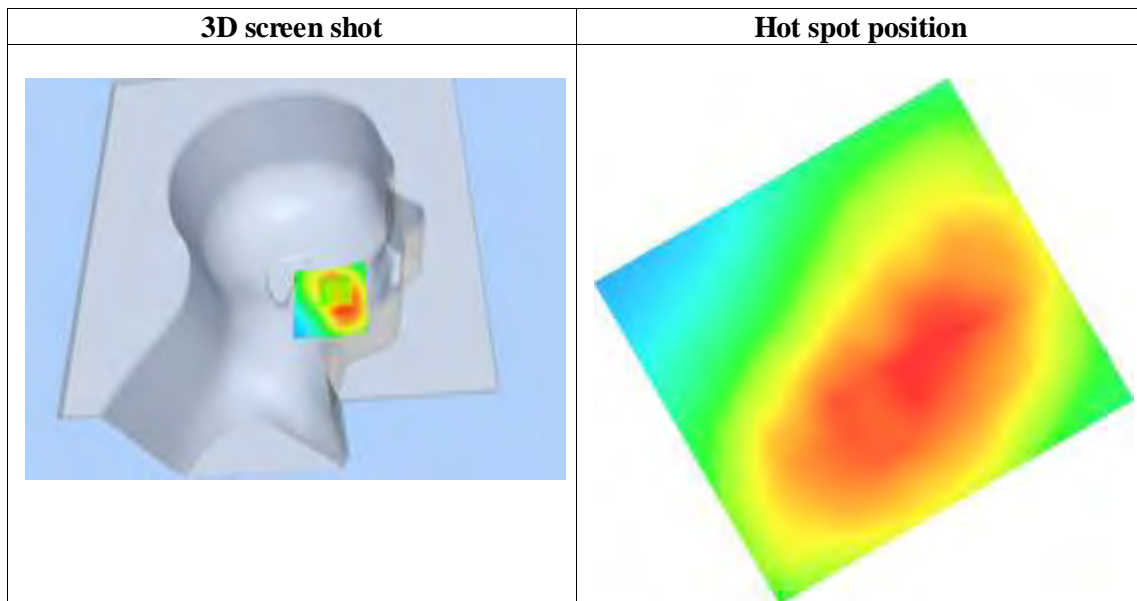
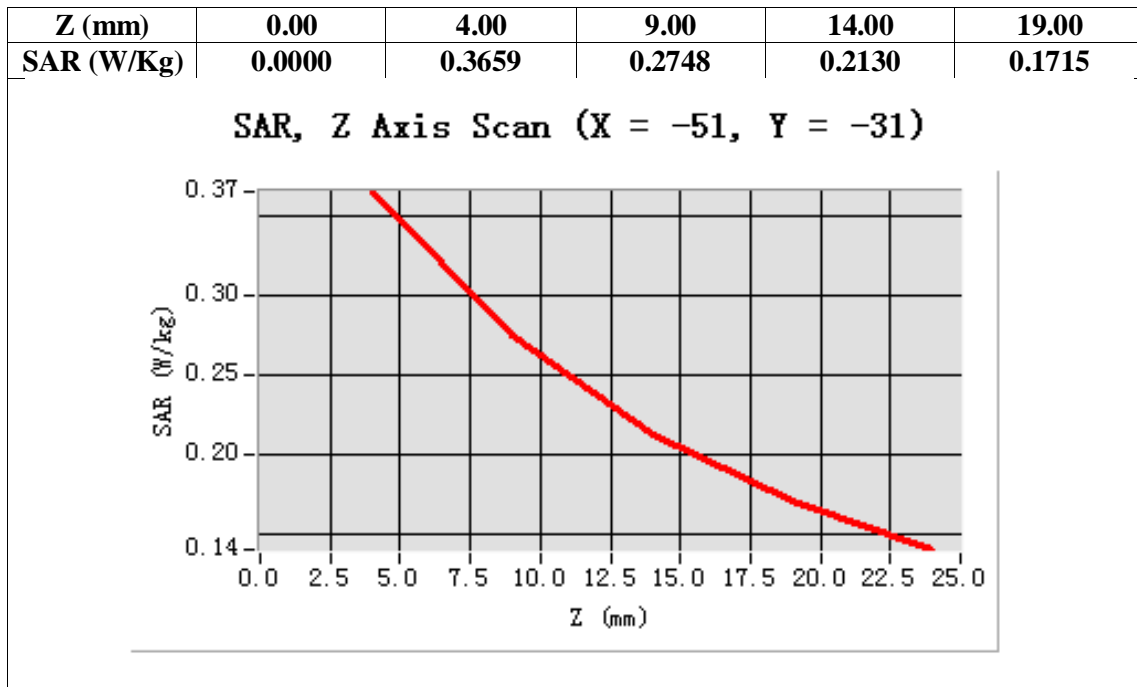

Test Laboratory: AGC Lab  
GSM 835 Mid-Tilt-Right <SIM 1>  
DUT: Mobile Phone; Type: QUE 5.0

Date: July 24,2014

Communication System: Generic GSM; Communication System Band: GSM 835; Duty Cycle: 1:8.3; Conv.F=5.27;  
Frequency: 836.6 MHz; Medium parameters used: f = 835 MHz;  $\sigma=0.88$  mho/m;  $\epsilon_r=41.91$  ;  $\rho= 1000$  kg/m<sup>3</sup> ;  
Phantom section: Right Section  
Ambient temperature (°C): 21.0, Liquid temperature (°C): 21.0

SATIMO Configuration:

- Probe: SSE5; Calibrated: 01/12/2014; Serial No.:SN 22/12 EP159
- Sensor-Surface: 4mm (Mechanical Surface Detection)
- Phantom: Flat Phantom; Type: Elliptical Phantom
- Measurement SW: OpenSAR V4\_02\_01

Configuration/GSM 835 Mid-Tilt-Right/Area Scan: Measurement grid: dx=8mm, dy=8mm  
Configuration/GSM 835 Mid-Tilt-Right/Zoom Scan: Measurement grid: dx=8mm, dy=8mm, dz=5mm;

Area Scan	sam_direct_droit2_surf8mm.txt
Zoom Scan	5x5x7,dx=8mm dy=8mm dz=5mm,Very fast
Phantom	Right head
Device Position	Tilt
Band	GSM 835
Channels	Middle
Signal	TDMA (Crest factor: 8.0)

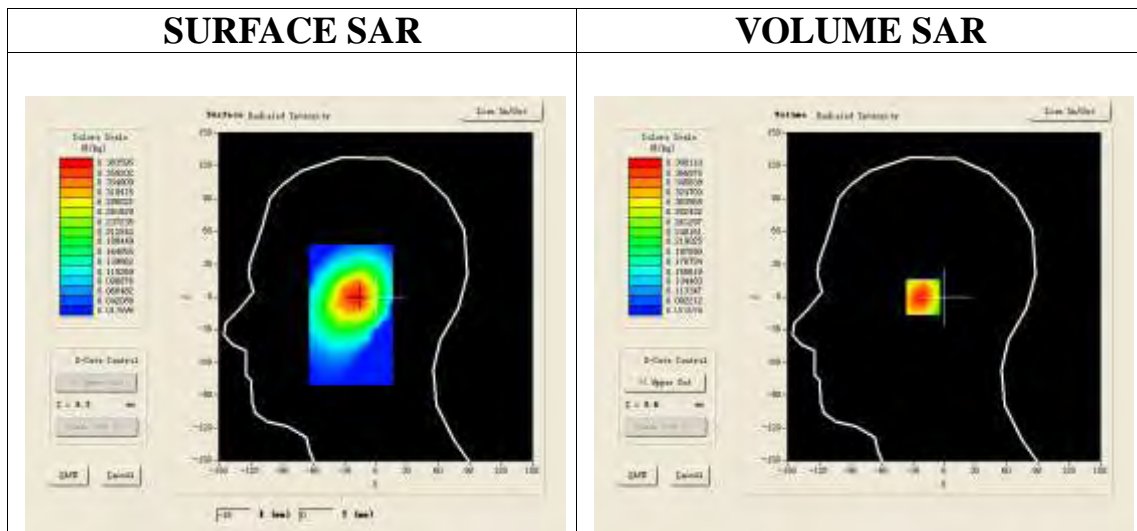

Maximum location: X=-17.00, Y=0.00

SAR 10g (W/Kg)	0.253268
SAR 1g (W/Kg)	0.375127

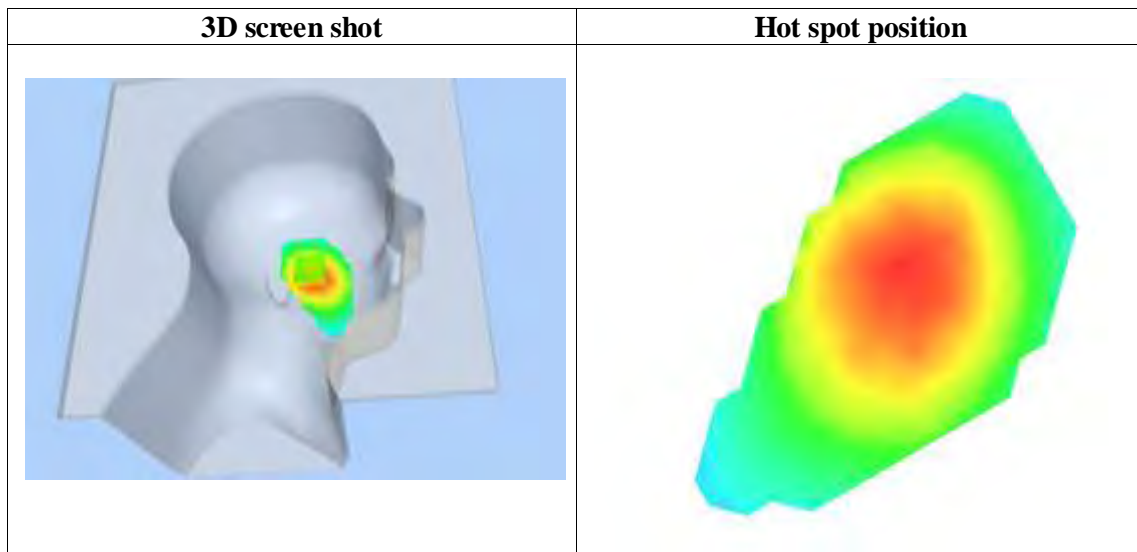
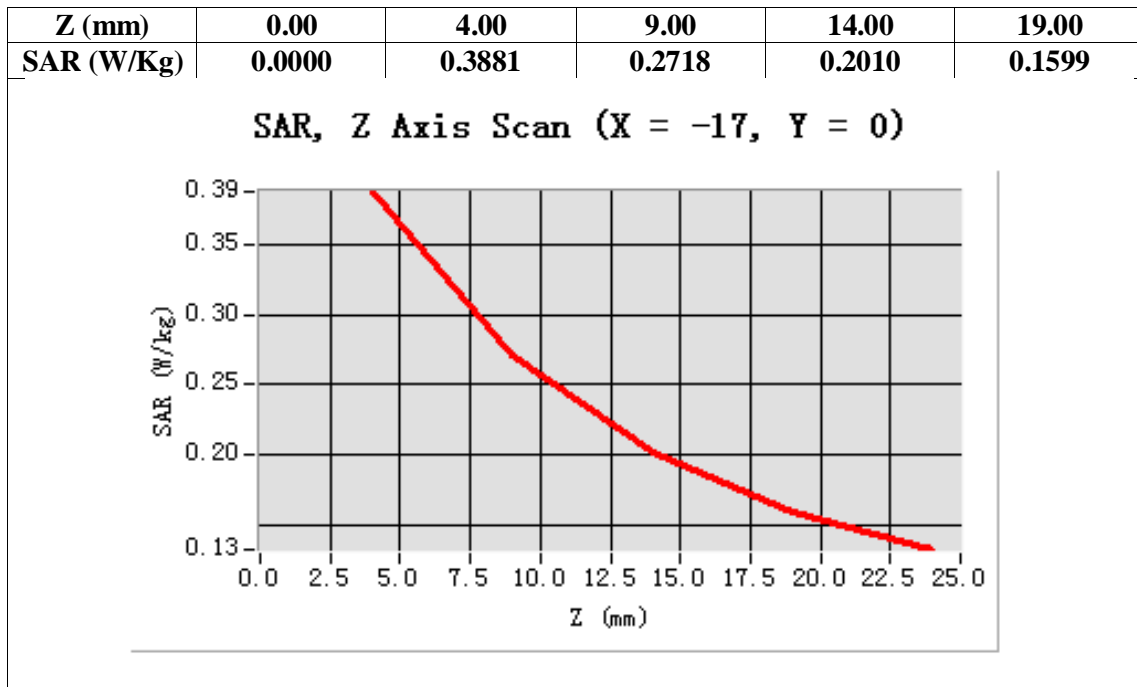

Test Laboratory: AGC Lab  
GSM 835 Mid-Touch-Left <SIM 2>  
DUT: Mobile Phone; Type: QUE 5.0

Date: July 24,2014

Communication System: Generic GSM; Communication System Band: GSM 835; Duty Cycle: 1:8.3; Conv.F=5.27  
Frequency: 836.6 MHz; Medium parameters used: f = 835 MHz;  $\sigma=0.88$  mho/m;  $\epsilon_r=41.91$ ;  $\rho=1000$  kg/m<sup>3</sup> ;  
Phantom section: Left Section  
Ambient temperature (°C): 21.0, Liquid temperature (°C): 21.0

SATIMO Configuration:

- Probe: SSE5; Calibrated: 01/12/2014; Serial No.:SN 22/12 EP159
- Sensor-Surface: 4mm (Mechanical Surface Detection)
- Phantom: Flat Phantom; Type: Elliptical Phantom
- Measurement SW: OpenSAR V4\_02\_01

Configuration/GSM 835 Mid-Touch-Left/Area Scan (6x8x1): Measurement grid: dx=8mm, dy=8mm  
Configuration/GSM 835 Mid-Touch-Left/Zoom Scan (5x5x7)/Cube 0: Measurement grid: dx=8mm, dy=8mm, dz=5mm

Area Scan	sam_direct_droit2_surf8mm.txt
ZoomScan	5x5x7,dx=8mm dy=8mm dz=5mm,Very fast
Phantom	Left head
Device Position	Cheek
Band	GSM 835
Channels	Middle
Signal	TDMA (Crest factor: 8.0)

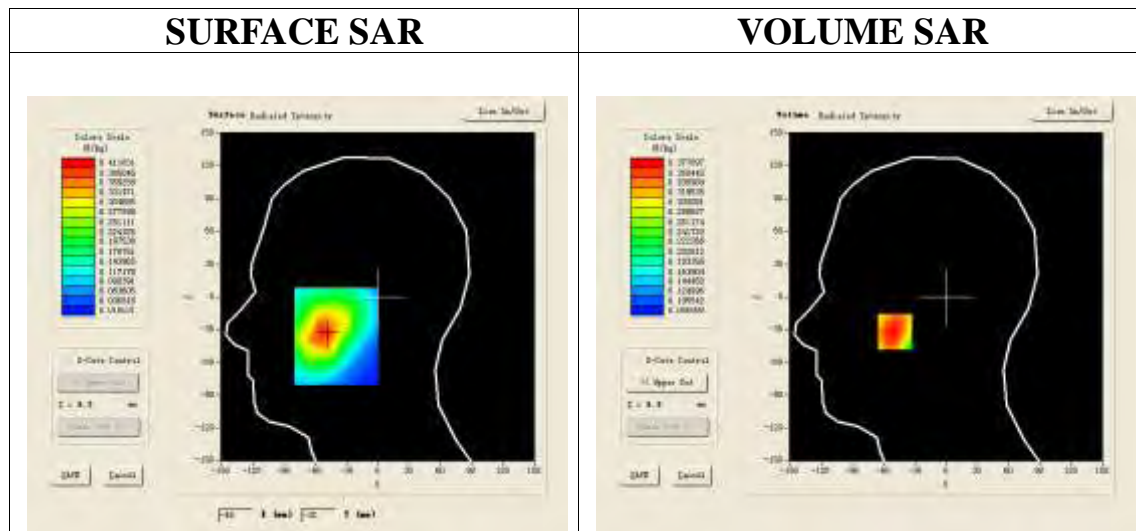

Maximum location: X=-49.00, Y=-32.00

SAR 10g (W/Kg)	0.274326
SAR 1g (W/Kg)	0.362706

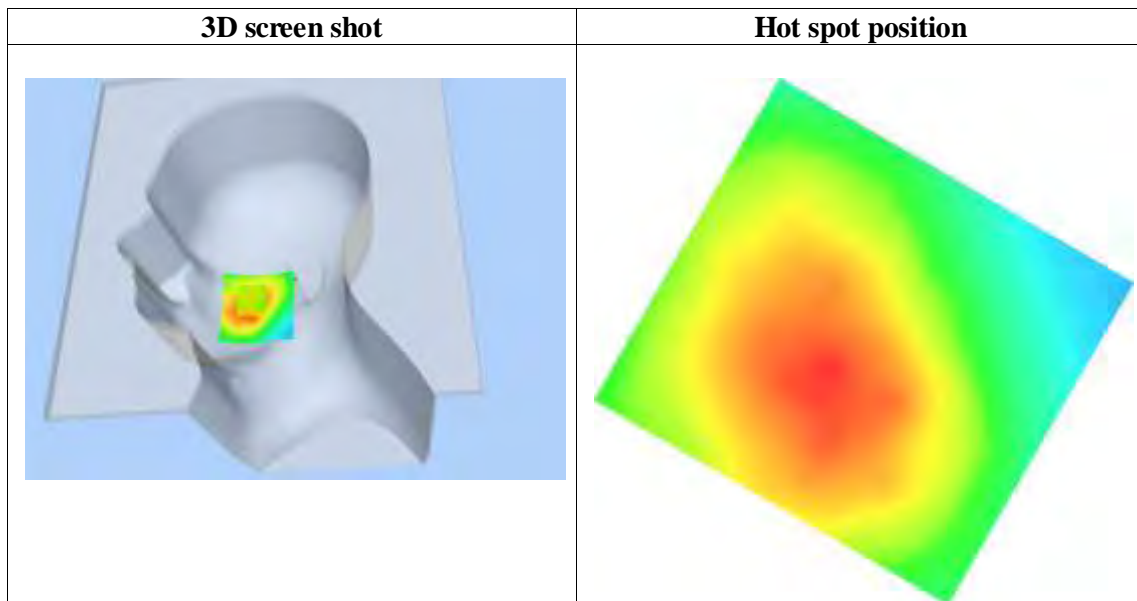
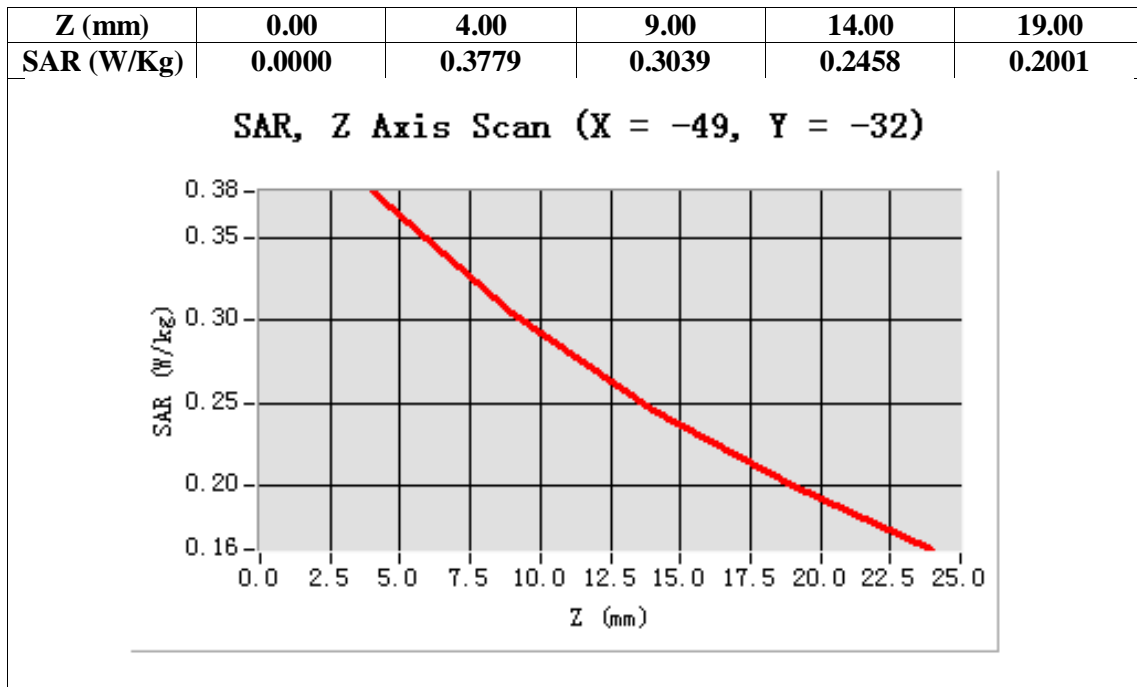

Test Laboratory: AGC Lab  
GSM 835 Mid- Body- Back <SIM 1>  
DUT: Mobile Phone; Type: QUE 5.0

Date: July 24,2014

Communication System: Generic GSM; Communication System Band: GSM 835; Duty Cycle: 1:8.3; Conv.F=5.48;  
Frequency: 836.6 MHz; Medium parameters used:  $f = 835$  MHz;  $\sigma = 0.96$  mho/m;  $\epsilon_r = 55.76$ ;  $\rho = 1000$  kg/m<sup>3</sup> ;  
Phantom section: Flat Section  
Ambient temperature (°C): 21.0, Liquid temperature (°C): 21.0

SATIMO Configuration:

- Probe: SSE5; Calibrated: 01/12/2014; Serial No.:SN 22/12 EP159
- Sensor-Surface: 4mm (Mechanical Surface Detection)
- Phantom: Flat Phantom; Type: Elliptical Phantom
- Measurement SW: OpenSAR V4\_02\_01

Configuration/GSM 835 Mid-Body-Back/Area Scan (6x8x1): Measurement grid: dx=8mm, dy=8mm  
Configuration/GSM 835 Mid-Body-Back/Zoom Scan (5x5x7)/Cube 0: Measurement grid: dx=8mm, dy=8mm, dz=5mm;

Area Scan	surf_sam_plan.txt
ZoomScan	5x5x7,dx=8mm dy=8mm dz=5mm,Very fast
Phantom	Validation plane
Device Position	Body Back
Band	GSM 835
Channels	Middle
Signal	TDMA (Crest factor: 8.0)

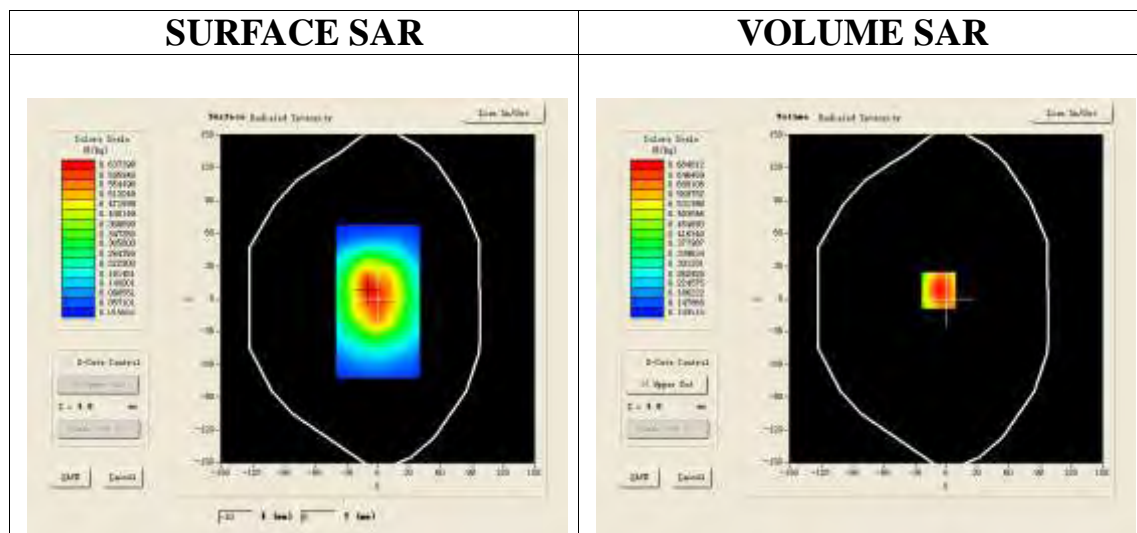

Maximum location: X=-7.00, Y=8.00

SAR 10g (W/Kg)	0.473762
SAR 1g (W/Kg)	0.707953

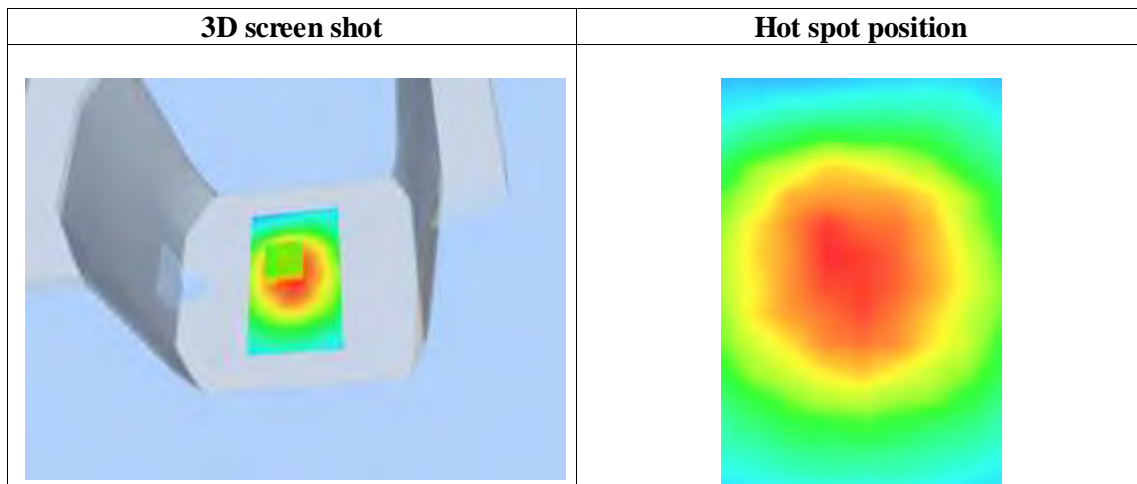
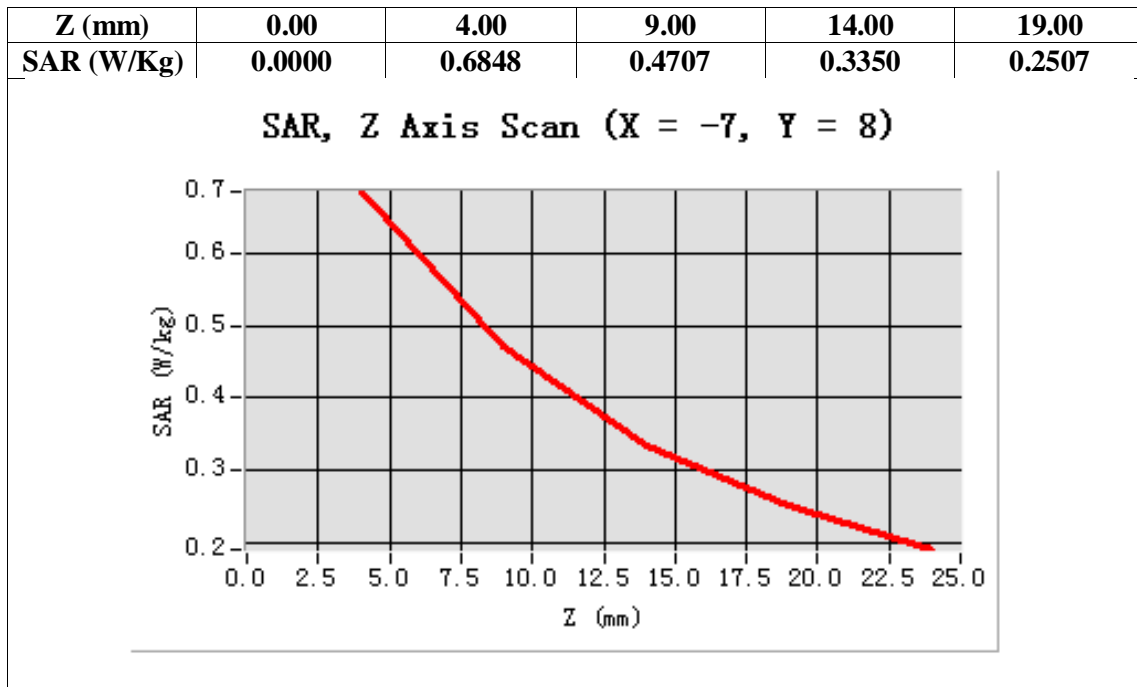



Test Laboratory: AGC Lab  
GSM 835 Mid- Body- Front (MS) <SIM 1>  
DUT: Mobile Phone; Type: QUE 5.0

Date: July 24,2014

Communication System: Generic GSM; Communication System Band: GSM 835; Duty Cycle: 1:8.3; Conv.F=5.48;  
Frequency: 836.6 MHz; Medium parameters used:  $f = 835$  MHz;  $\sigma = 0.96$  mho/m;  $\epsilon_r = 55.76$ ;  $\rho = 1000$  kg/m<sup>3</sup> ;  
Phantom section: Flat Section  
Ambient temperature (°C): 21.0, Liquid temperature (°C): 21.0

SATIMO Configuration:

- Probe: SSE5; Calibrated: 01/12/2014; Serial No.:SN 22/12 EP159
- Sensor-Surface: 4mm (Mechanical Surface Detection)
- Phantom: Flat Phantom; Type: Elliptical Phantom
- Measurement SW: OpenSAR V4\_02\_01

Configuration/GSM 835 Mid-Body- Front /Area Scan (6x8x1): Measurement grid: dx=8mm, dy=8mm  
Configuration/GSM 835 Mid-Body- Front Zoom Scan (5x5x7)/Cube 0: Measurement grid: dx=8mm, dy=8mm, dz=5mm;

Area Scan	surf_sam_plan.txt
ZoomScan	5x5x7,dx=8mm dy=8mm dz=5mm,Very fast
Phantom	Validation plane
Device Position	Body Front
Band	GSM 835
Channels	Middle
Signal	TDMA (Crest factor: 8.0)

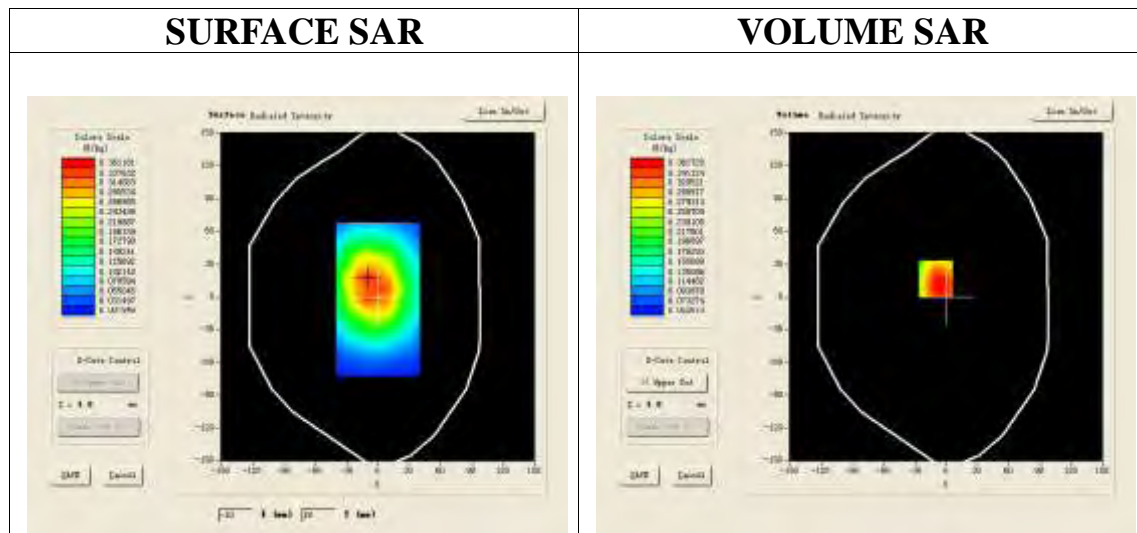

Maximum location: X=-10.00, Y=17.00

SAR 10g (W/Kg)	0.253426
SAR 1g (W/Kg)	0.384327

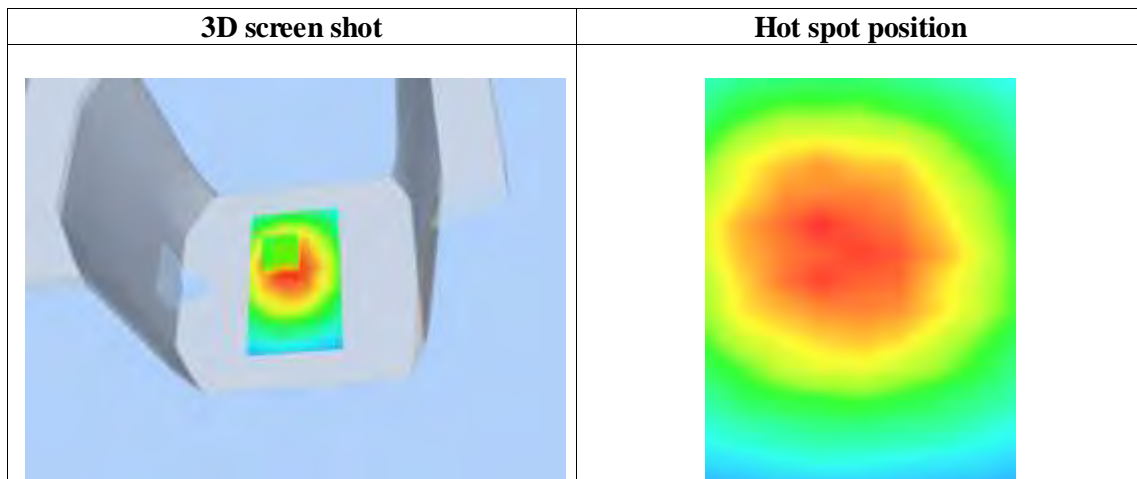
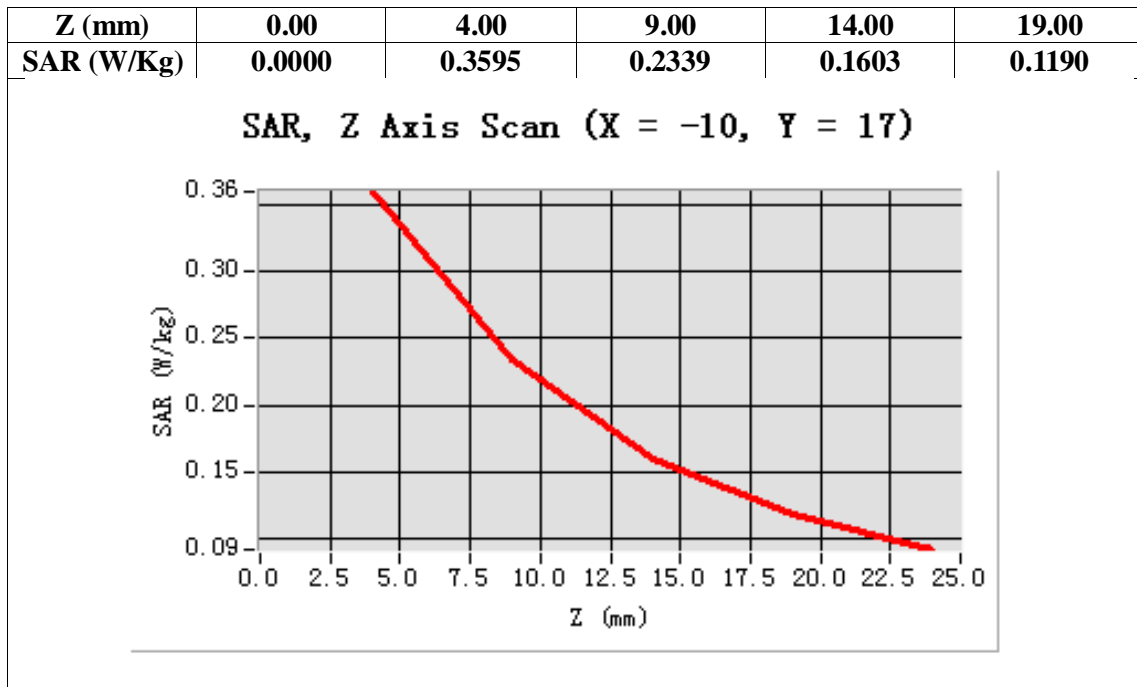

Test Laboratory: AGC Lab  
PCS 1900 Mid-Touch-Left <SIM 1>  
DUT: Mobile Phone; Type: QUE 5.0

Date: July 24,2014

Communication System: Generic GSM; Communication System Band: PCS 1900; Duty Cycle: 1:8.3; Conv.F=4.51;  
Frequency: 1880 MHz; Medium parameters used:  $f = 1900$  MHz;  $\sigma = 1.42$  mho/m;  $\epsilon_r = 40.41$ ;  $\rho = 1000$  kg/m<sup>3</sup> ;  
Phantom section: Left Section  
Ambient temperature (°C): 21.0, Liquid temperature (°C): 21.0

SATIMO Configuration:

- Probe: SSE5; Calibrated: 01/12/2014; Serial No.:SN 22/12 EP159
- Sensor-Surface: 4mm (Mechanical Surface Detection)
- Phantom: Flat Phantom; Type: Elliptical Phantom
- Measurement SW: OpenSAR V4\_02\_01

Configuration/PCS1900 Mid-Touch-Left/Area Scan: Measurement grid: dx=8mm, dy=8mm  
Configuration/PCS1900 Mid-Touch-Left/Zoom Scan: Measurement grid: dx=8mm, dy=8mm, dz=5mm;

Area Scan	sam_direct_droit2_surf8mm.txt
ZoomScan	5x5x7,dx=8mm dy=8mm dz=5mm,Very fast
Phantom	Left head
Device Position	Cheek
Band	PCS 1900
Channels	Middle
Signal	TDMA (Crest factor: 8.0)

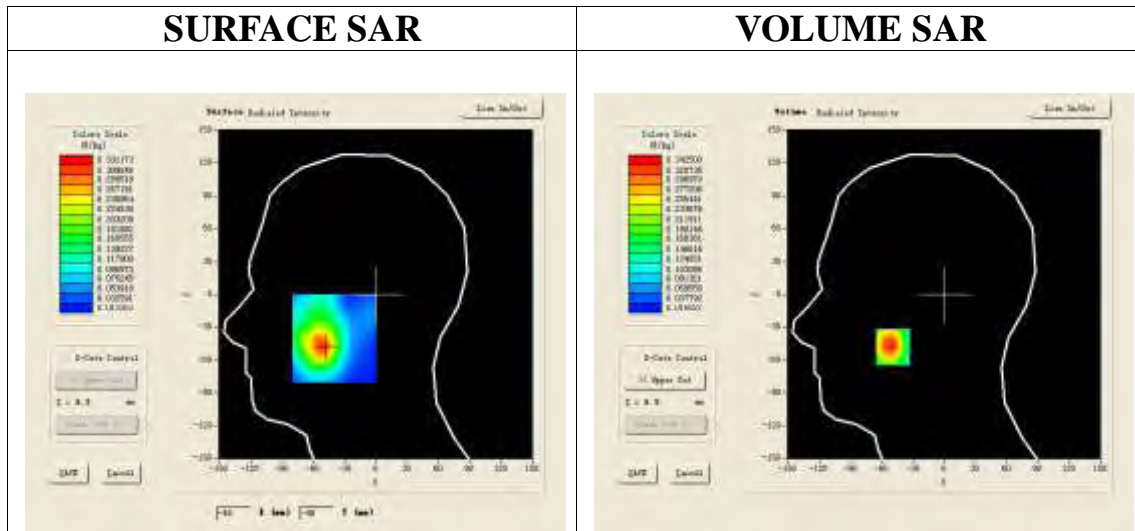

Maximum location: X=-49.00, Y=-48.00

SAR 10g (W/Kg)	0.197536
SAR 1g (W/Kg)	0.323217

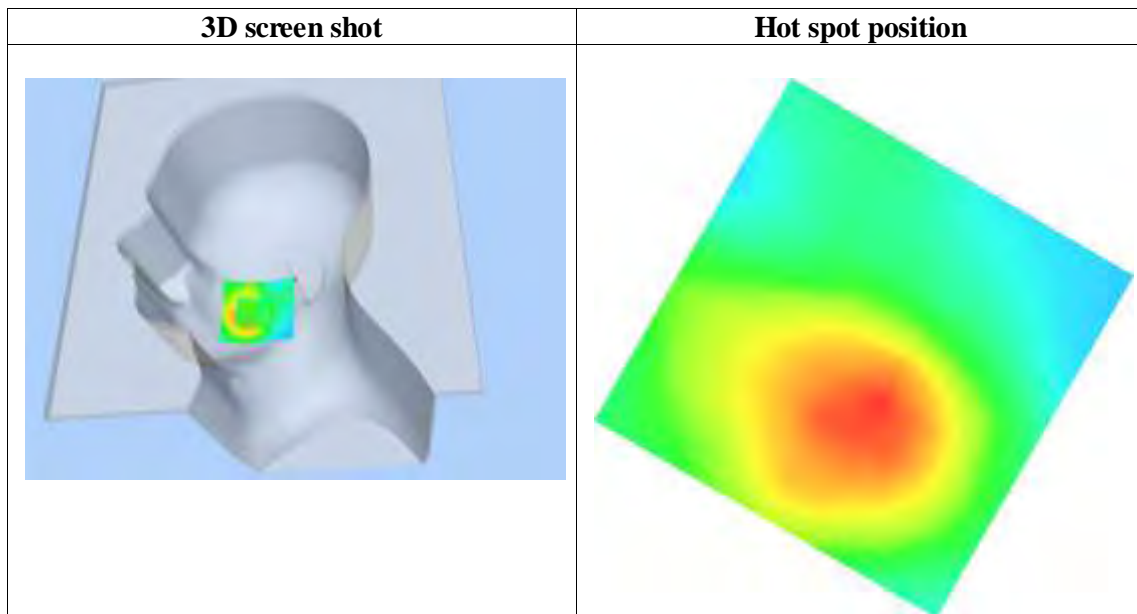
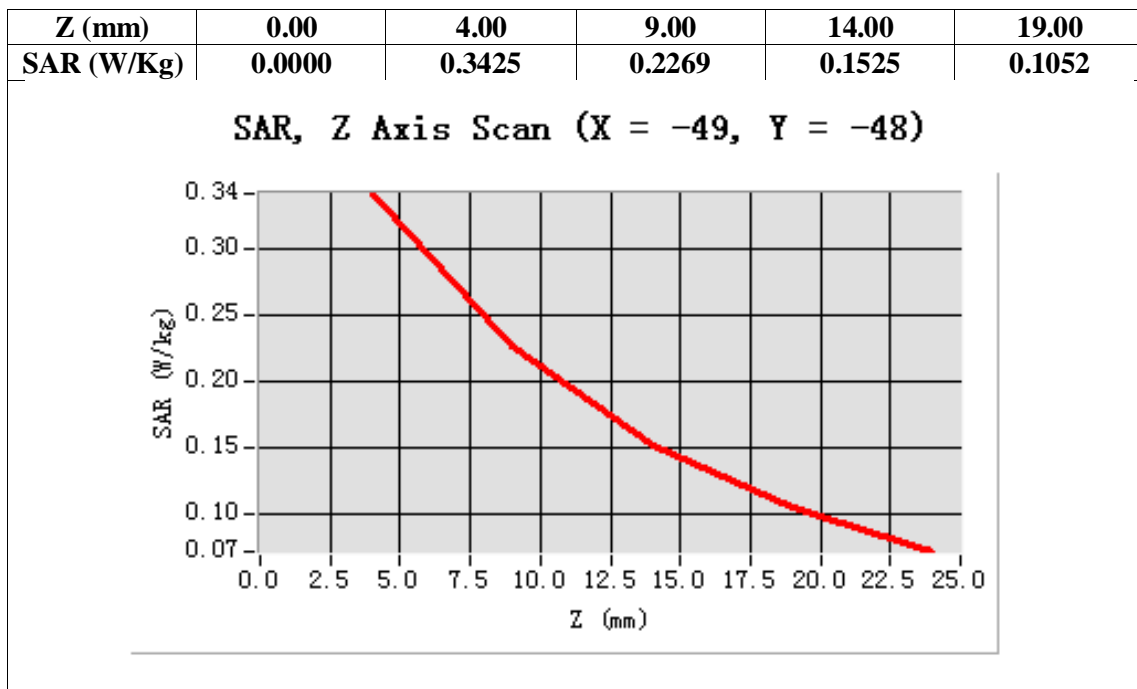

Test Laboratory: AGC Lab  
PCS 1900 Mid-Tilt-Left <SIM 1>  
DUT: Mobile Phone; Type: QUE 5.0

Date: July 24,2014

Communication System: Generic GSM; Communication System Band: PCS 1900; Duty Cycle: 1:8.3; Conv.F=4.51;  
Frequency: 1880 MHz; Medium parameters used:  $f = 1900$  MHz;  $\sigma = 1.42$  mho/m;  $\epsilon_r = 40.41$ ;  $\rho = 1000$  kg/m<sup>3</sup> ;  
Phantom section: Left Section  
Ambient temperature (°C): 21.0, Liquid temperature (°C): 21.0

SATIMO Configuration:

- Probe: SSE5; Calibrated: 01/12/2014; Serial No.:SN 22/12 EP159
- Sensor-Surface: 4mm (Mechanical Surface Detection)
- Phantom: Flat Phantom; Type: Elliptical Phantom
- Measurement SW: OpenSAR V4\_02\_01

Configuration/PCS1900 Mid-Tilt-Left/Area Scan: Measurement grid: dx=8mm, dy=8mm  
Configuration/PCS1900 Mid-Tilt-Left/Zoom Scan: Measurement grid: dx=8mm, dy=8mm,dz=5mm;

Area Scan	sam_direct_droit2_surf8mm.txt
ZoomScan	5x5x7,dx=8mm dy=8mm dz=5mm,Very fast
Phantom	Left head
Device Position	Tilt
Band	PCS 1900
Channels	Middle
Signal	TDMA (Crest factor: 8.0)

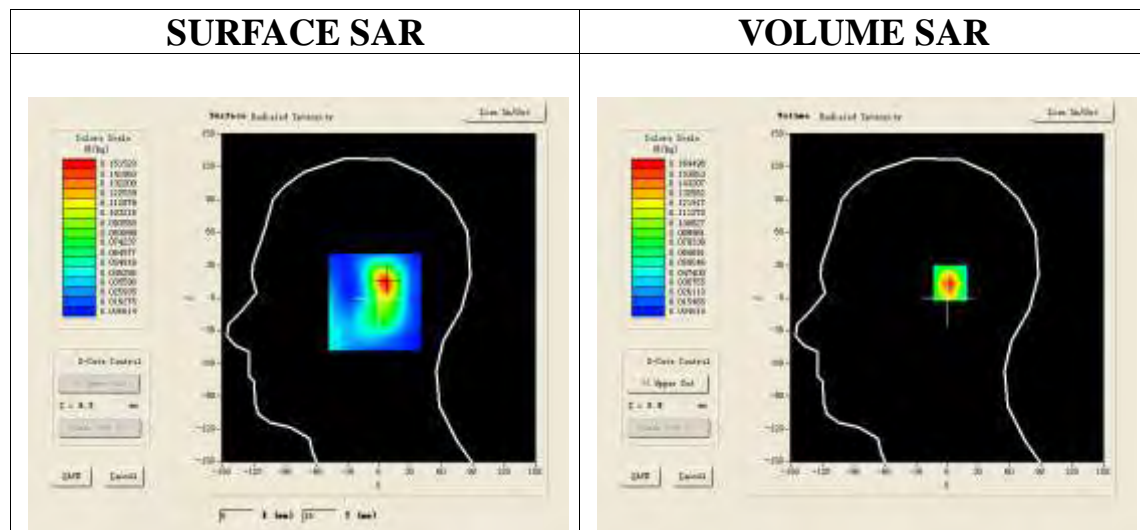

Maximum location: X=7.00, Y=14.00

SAR 10g (W/Kg)	0.083764
SAR 1g (W/Kg)	0.155721

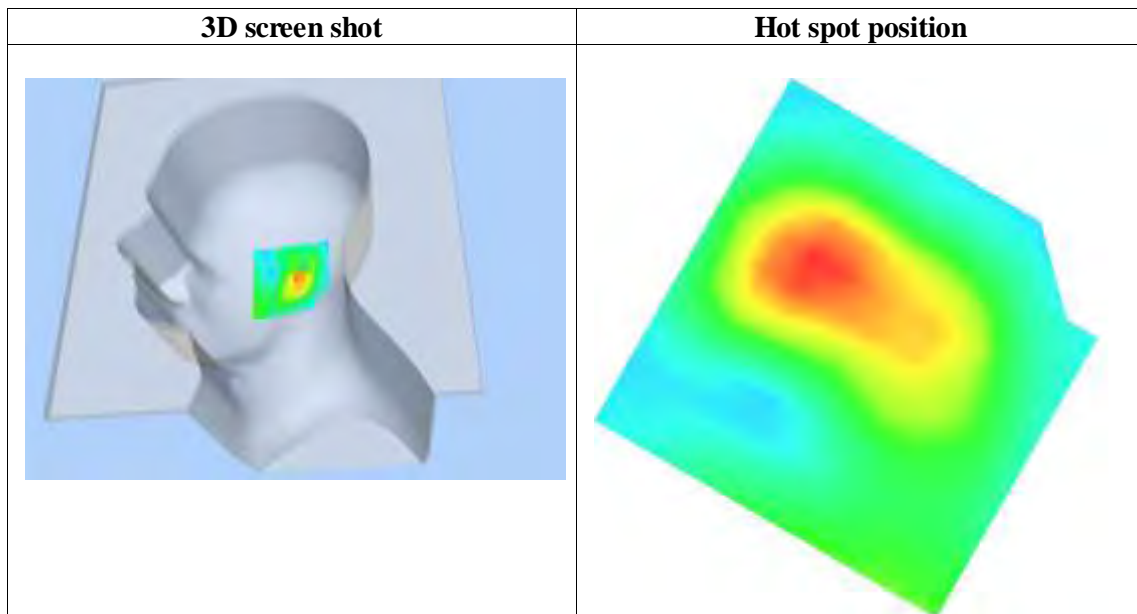
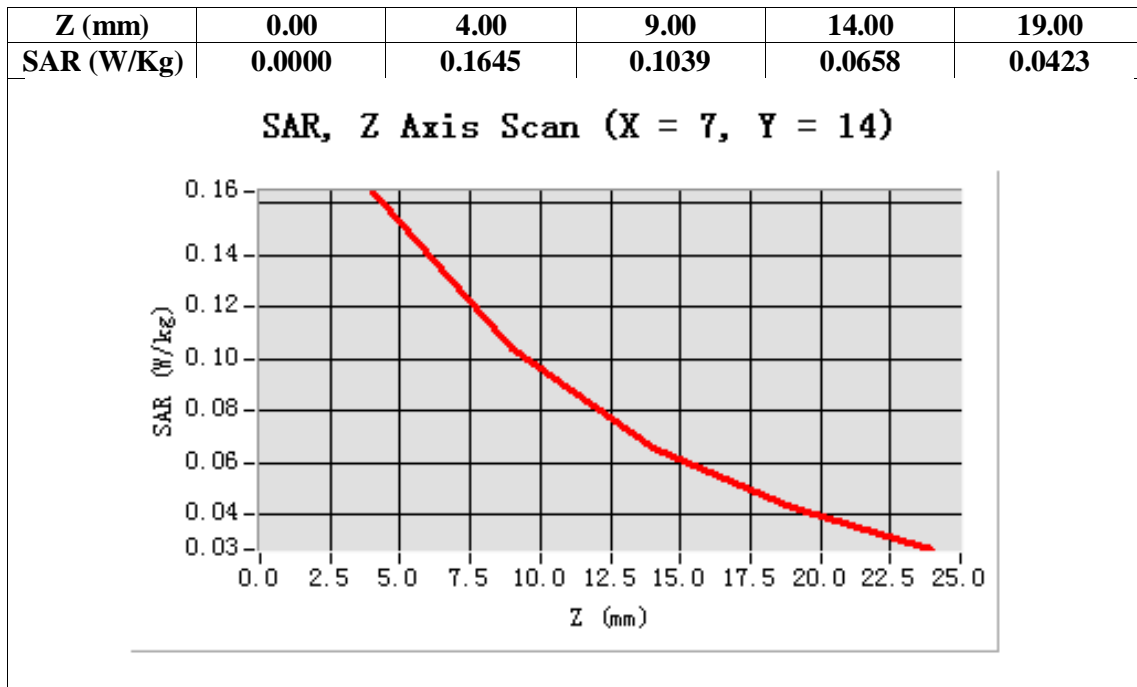

Test Laboratory: AGC Lab  
PCS 1900 Mid-Touch-Right <SIM 1>  
DUT: Mobile Phone; Type: QUE 5.0

Date: July 24,2014

Communication System: Generic GSM; Communication System Band: PCS 1900; Duty Cycle: 1:8.3; Conv.F=4.51;  
Frequency: 1880 MHz; Medium parameters used:  $f = 1900$  MHz;  $\sigma = 1.42$  mho/m;  $\epsilon_r = 40.41$ ;  $\rho = 1000$  kg/m<sup>3</sup> ;  
Phantom section: Right Section  
Ambient temperature (°C): 21.0, Liquid temperature (°C): 21.0

SATIMO Configuration:

- Probe: SSE5; Calibrated: 01/12/2014; Serial No.:SN 22/12 EP159
- Sensor-Surface: 4mm (Mechanical Surface Detection)
- Phantom: Flat Phantom; Type: Elliptical Phantom
- Measurement SW: OpenSAR V4\_02\_01

Configuration/PCS1900 Mid-Touch-Right/Area Scan: Measurement grid: dx=8mm, dy=8mm  
Configuration/PCS1900 Mid-Touch-Right/Zoom Scan: Measurement grid: dx=8mm, dy=8mm, dz=5mm;

Area Scan	sam_direct_droit2_surf8mm.txt
ZoomScan	5x5x7,dx=8mm dy=8mm dz=5mm,Very fast
Phantom	Right head
Device Position	Cheek
Band	PCS 1900
Channels	Middle
Signal	TDMA (Crest factor: 8.0)

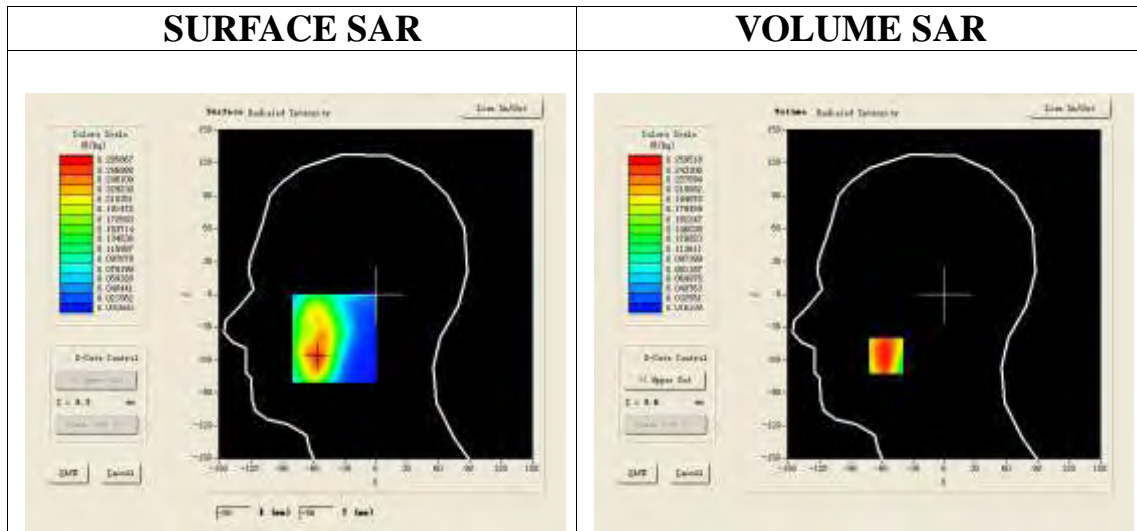

Maximum location: X=-56.00, Y=-56.00

SAR 10g (W/Kg)	0.154805
SAR 1g (W/Kg)	0.243287

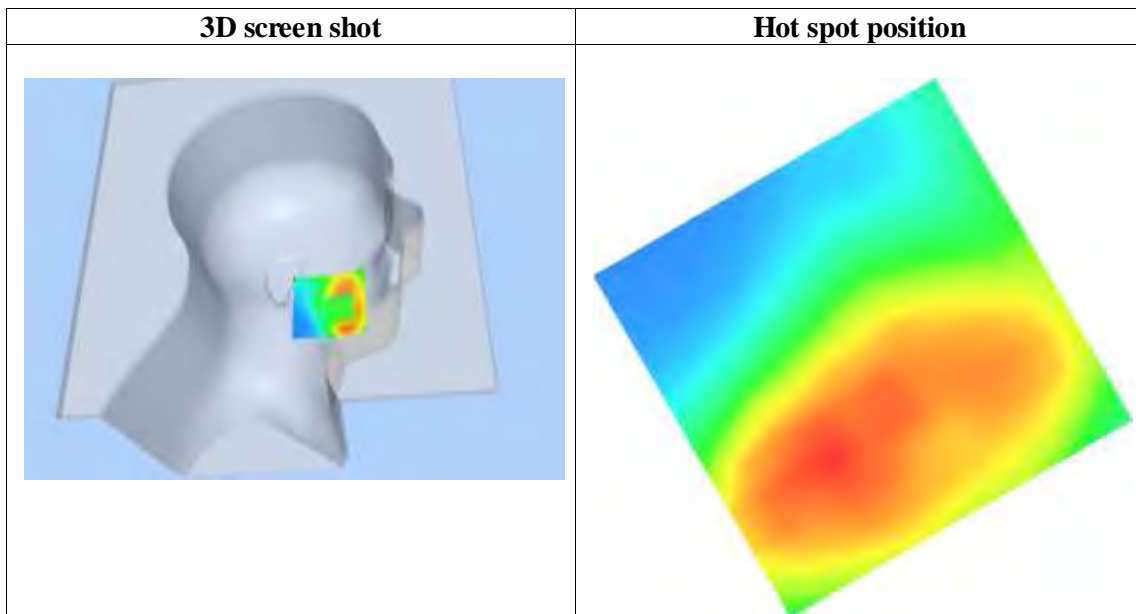
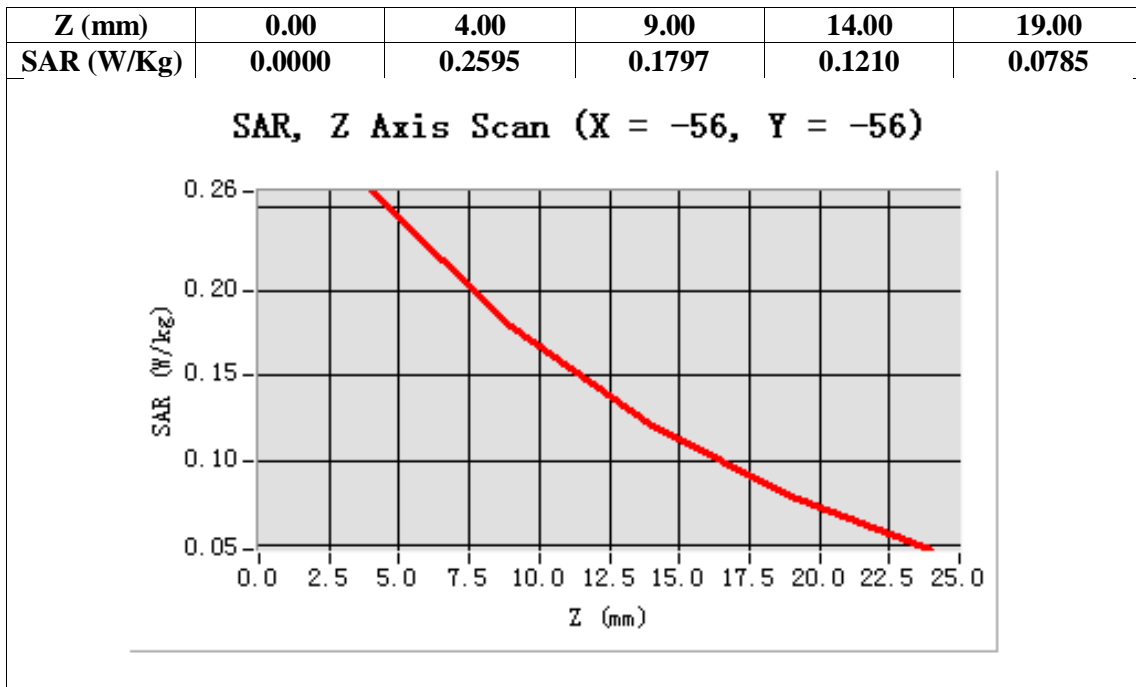



Test Laboratory: AGC Lab  
PCS 1900 Mid-Tilt-Right <SIM 1>  
DUT: Mobile Phone; Type: QUE 5.0

Date: July 24,2014

Communication System: Generic GSM; Communication System Band: PCS 1900; Duty Cycle: 1:8.3; Conv.F=4.51;  
Frequency: 1880 MHz; Medium parameters used:  $f = 1900$  MHz;  $\sigma = 1.42$  mho/m;  $\epsilon_r = 40.41$ ;  $\rho = 1000$  kg/m<sup>3</sup> ;  
Phantom section: Right Section  
Ambient temperature (°C): 21.0, Liquid temperature (°C): 21.0

SATIMO Configuration:

- Probe: SSE5; Calibrated: 01/12/2014; Serial No.:SN 22/12 EP159
- Sensor-Surface: 4mm (Mechanical Surface Detection)
- Phantom: Flat Phantom; Type: Elliptical Phantom
- Measurement SW: OpenSAR V4\_02\_01

Configuration/PCS1900 Mid-Tilt-Right/Area Scan: Measurement grid: dx=8mm, dy=8mm  
Configuration/PCS1900 Mid-Tilt-Right/Zoom Scan: Measurement grid: dx=8mm,  
dy=8mm, dz=5mm;

Area Scan	sam_direct_droit2_surf8mm.txt
ZoomScan	5x5x7,dx=8mm dy=8mm dz=5mm,Very fast
Phantom	Right head
Device Position	Tilt
Band	PCS 1900
Channels	Middle
Signal	TDMA (Crest factor: 8.0)

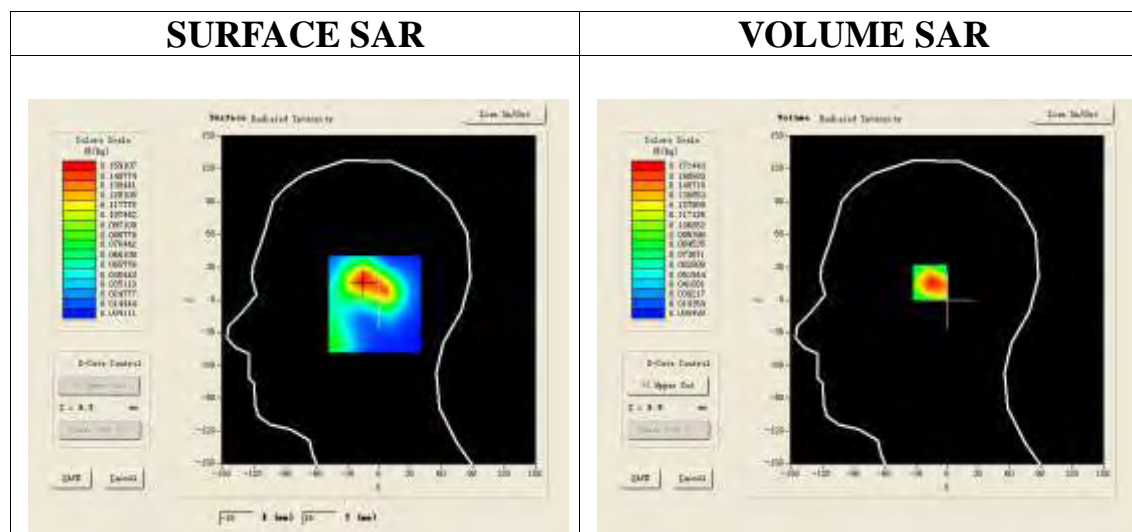

Maximum location: X=-15.00, Y=17.00

SAR 10g (W/Kg)	0.09436
SAR 1g (W/Kg)	0.165984

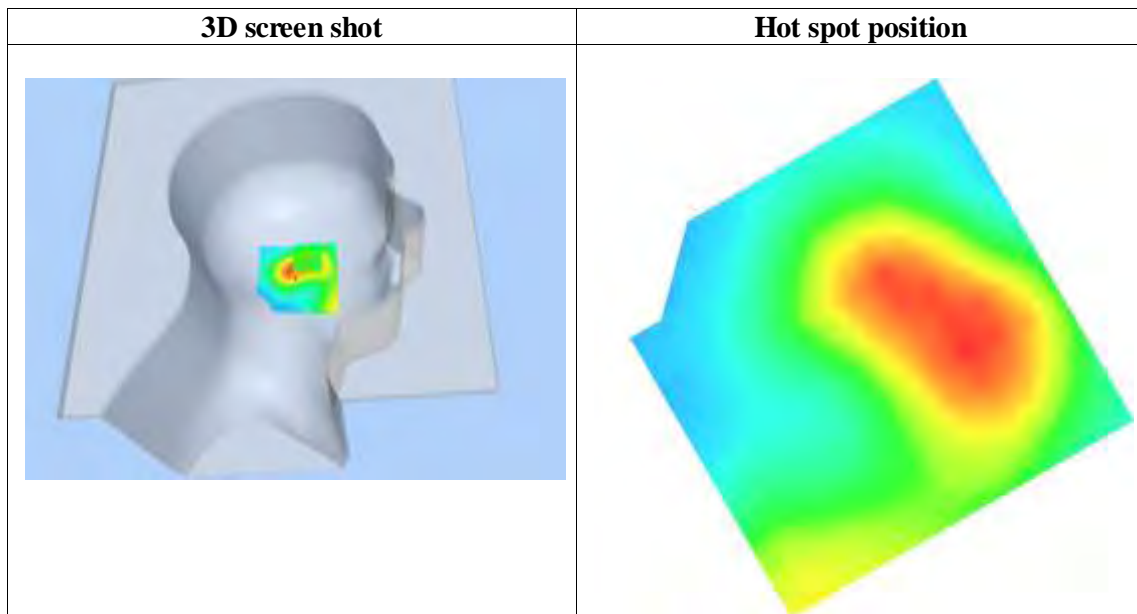
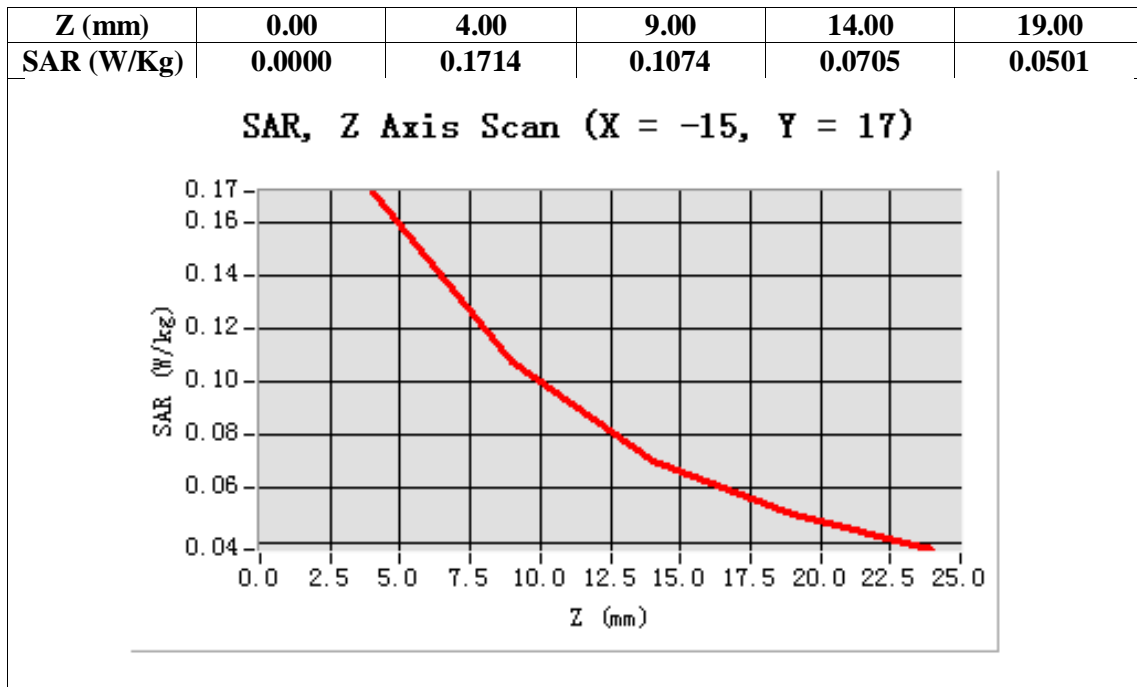

Test Laboratory: AGC Lab  
PCS 1900 Mid-Touch-Left <SIM 2>  
DUT: Mobile Phone; Type: QUE 5.0

Date: July 24,2014

Communication System: Generic GSM; Communication System Band: PCS 1900; Duty Cycle: 1:8.3; Conv.F=4.51;  
Frequency: 1880 MHz; Medium parameters used:  $f = 1900$  MHz;  $\sigma = 1.42$  mho/m;  $\epsilon_r = 40.41$ ;  $\rho = 1000$  kg/m<sup>3</sup> ;  
Phantom section: Left Section  
Ambient temperature (°C): 21.0, Liquid temperature (°C): 21.0

SATIMO Configuration:

- Probe: SSE5; Calibrated: 01/12/2014; Serial No.:SN 22/12 EP159
- Sensor-Surface: 4mm (Mechanical Surface Detection)
- Phantom: Flat Phantom; Type: Elliptical Phantom
- Measurement SW: OpenSAR V4\_02\_01

Configuration/PCS1900 Mid-Touch-Left/Area Scan: Measurement grid: dx=8mm, dy=8mm  
Configuration/PCS1900 Mid-Touch-Left/Zoom Scan: Measurement grid: dx=8mm, dy=8mm, dz=5mm;

Area Scan	sam_direct_droit2_surf8mm.txt
ZoomScan	5x5x7,dx=8mm dy=8mm dz=5mm,Very fast
Phantom	Left head
Device Position	Cheek
Band	PCS 1900
Channels	Middle
Signal	TDMA (Crest factor: 8.0)

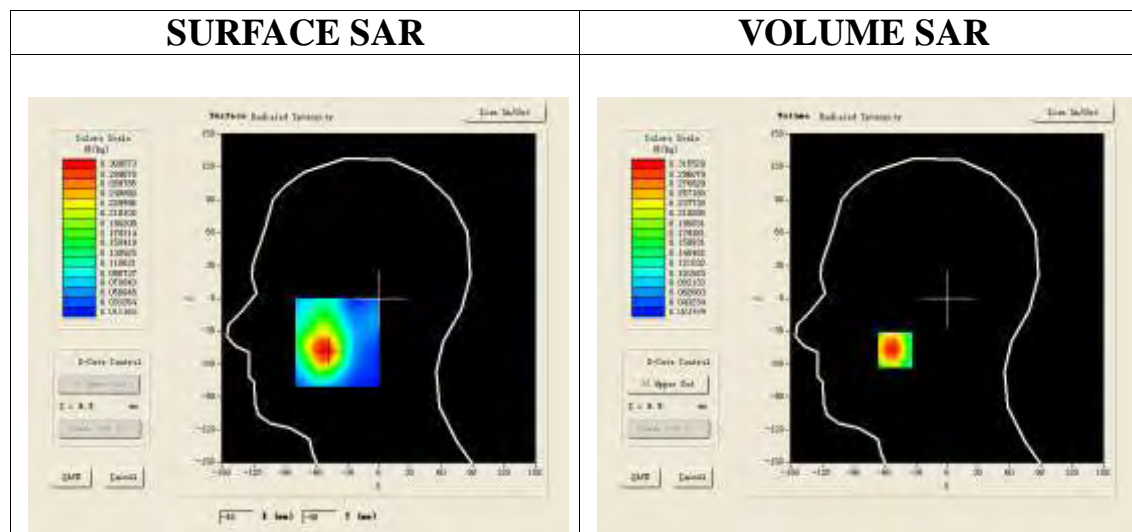

Maximum location: X=-50.00, Y=-47.00

SAR 10g (W/Kg)	0.194527
SAR 1g (W/Kg)	0.305638

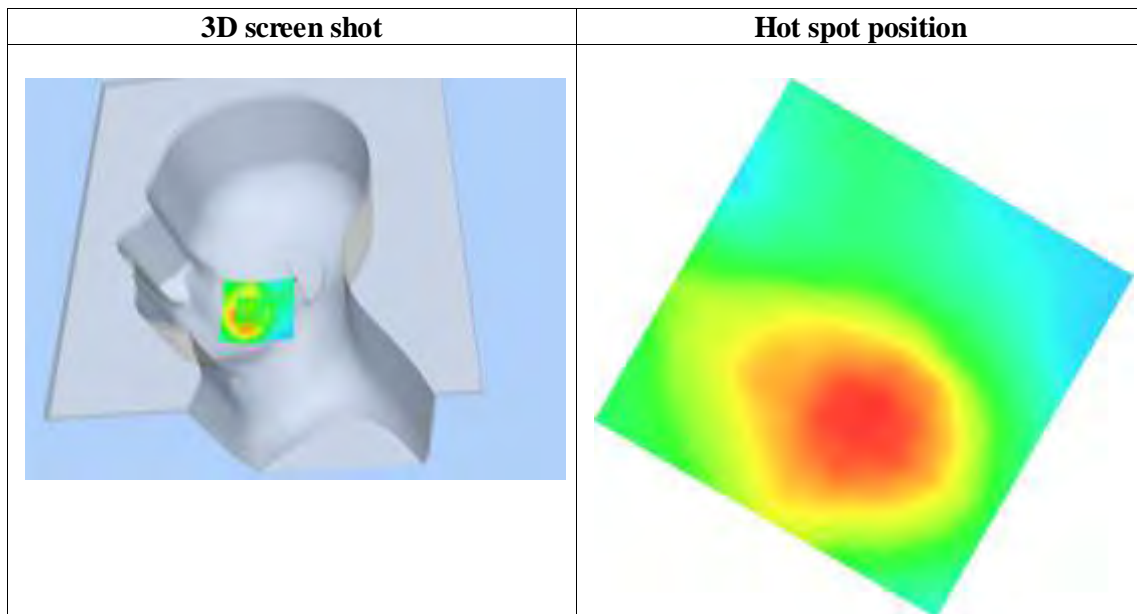
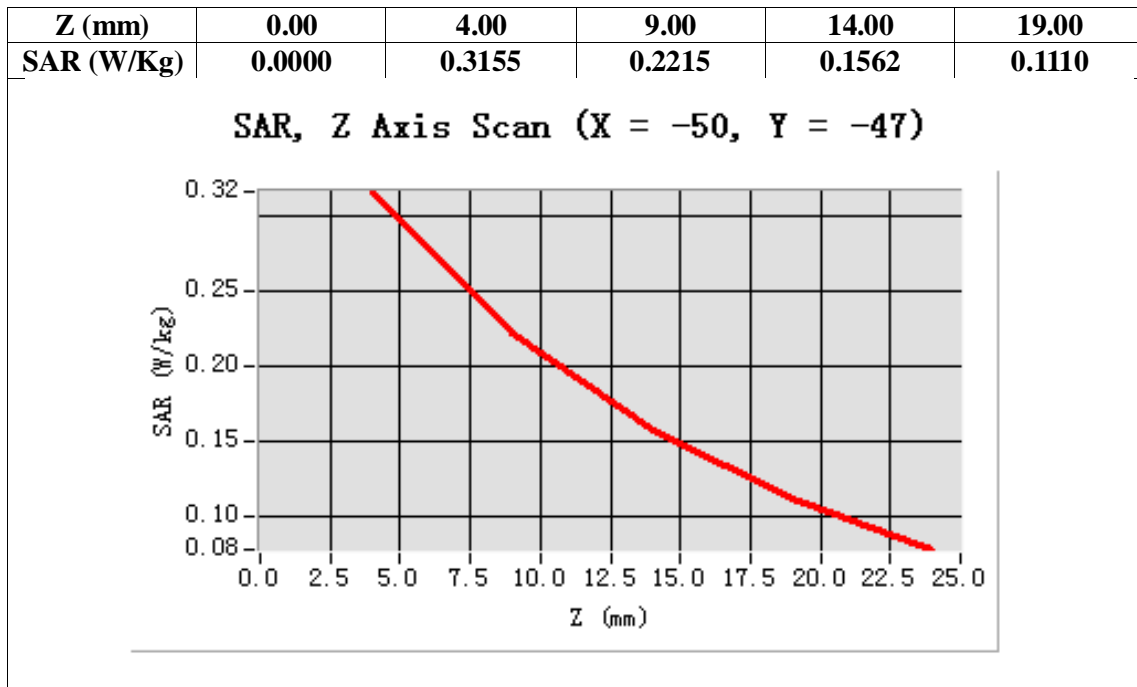

Test Laboratory: AGC Lab  
PCS 1900 Mid-Body- Back <SIM 1>  
DUT: Mobile Phone; Type: QUE 5.0

Date: July 24,2014

Communication System: Generic GSM; Communication System Band: PCS 1900; Duty Cycle: 1:8.3; Conv.F=4.45;  
Frequency: 1880 MHz; Medium parameters used:  $f = 1900$  MHz;  $\sigma = 1.53$  mho/m;  $\epsilon_r = 53.79$ ;  $\rho = 1000$  kg/m<sup>3</sup> ;  
Phantom section: Flat Section  
Ambient temperature (°C): 21.0, Liquid temperature (°C): 21.0

SATIMO Configuration:

- Probe: SSE5; Calibrated: 01/12/2014; Serial No.:SN 22/12 EP159
- Sensor-Surface: 4mm (Mechanical Surface Detection)
- Phantom: Flat Phantom; Type: Elliptical Phantom
- Measurement SW: OpenSAR V4\_02\_01

Configuration/PCS1900 Mid-Body-Back/Area Scan: Measurement grid: dx=8mm, dy=8mm  
Configuration/PCS1900 Mid-Body-Back/Zoom Scan: Measurement grid: dx=8mm, dy=8mm, dz=5mm;

Area Scan	surf_sam_plan.txt
ZoomScan	5x5x7,dx=8mm dy=8mm dz=5mm,Very fast
Phantom	Validation plane
Device Position	Body Back
Band	PCS 1900
Channels	Middle
Signal	TDMA (Crest factor: 8.0)

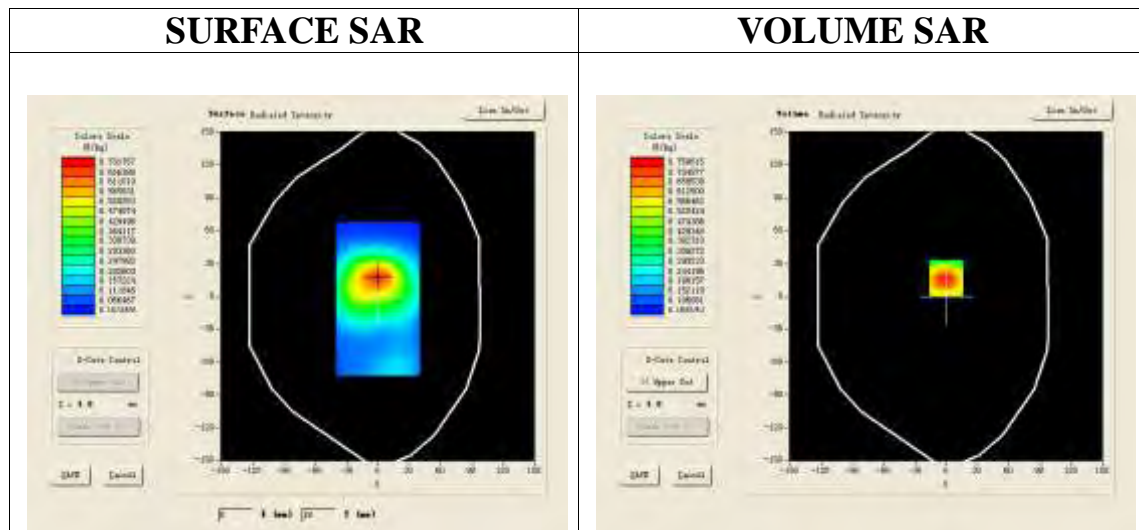

Maximum location: X=0.00, Y=17.00

SAR 10g (W/Kg)	0.465438
SAR 1g (W/Kg)	0.764981

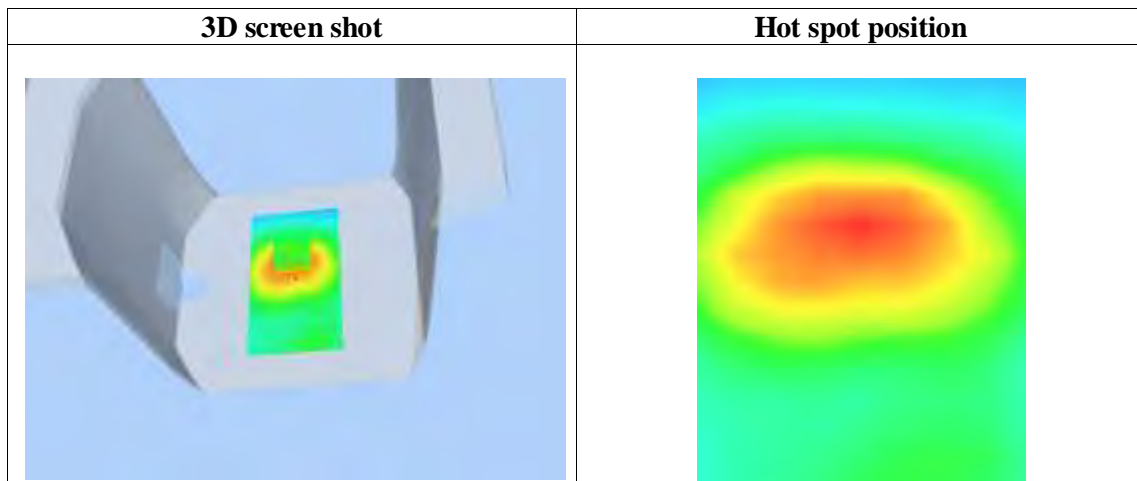
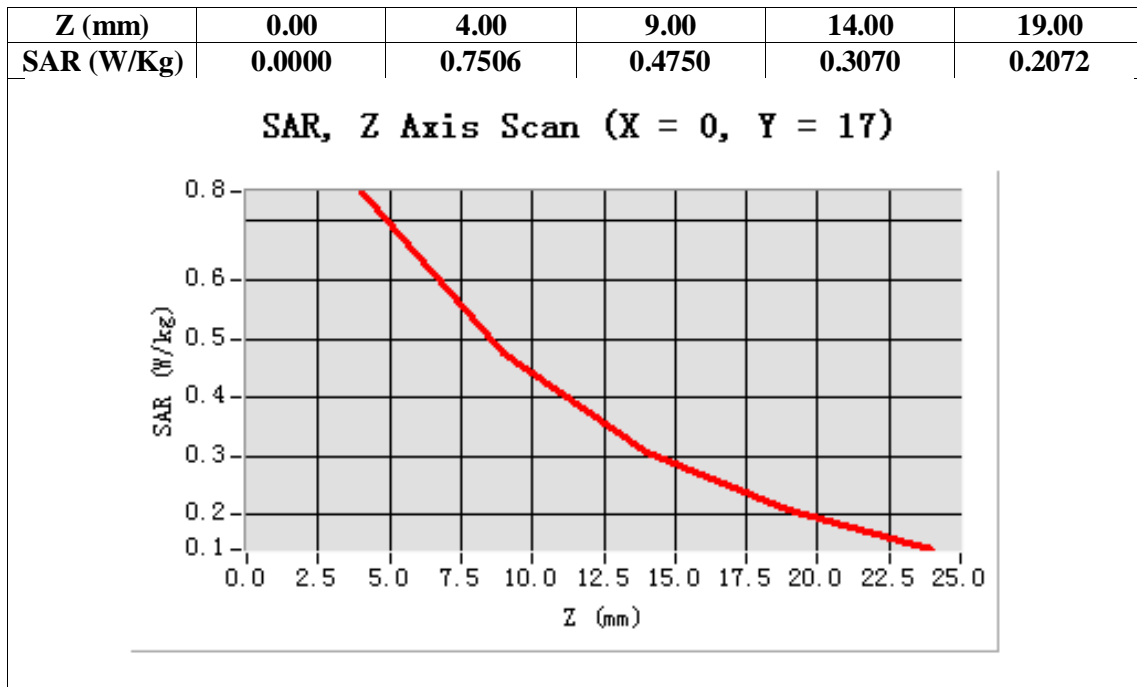

Test Laboratory: AGC Lab  
PCS 1900 Mid-Body -Front (MS) <SIM 1>  
DUT: Mobile Phone; Type: QUE 5.0

Date: July 24,2014

Communication System: Generic GSM; Communication System Band: PCS 1900; Duty Cycle: 1:8.3; Conv.F=4.45;  
Frequency: 1880 MHz; Medium parameters used:  $f = 1900$  MHz;  $\sigma = 1.53$  mho/m;  $\epsilon_r = 53.79$ ;  $\rho = 1000$  kg/m<sup>3</sup> ;  
Phantom section: Flat Section  
Ambient temperature (°C): 21.0, Liquid temperature (°C): 21.0

SATIMO Configuration:

- Probe: SSE5; Calibrated: 01/12/2014; Serial No.:SN 22/12 EP159
- Sensor-Surface: 4mm (Mechanical Surface Detection)
- Phantom: Flat Phantom; Type: Elliptical Phantom
- Measurement SW: OpenSAR V4\_02\_01

Configuration/PCS1900 Mid-Body- Front /Area Scan: Measurement grid: dx=8mm, dy=8mm  
Configuration/PCS1900 Mid-Body- Front /Zoom Scan: Measurement grid: dx=8mm, dy=8mm, dz=5mm;

Area Scan	surf_sam_plan.txt
ZoomScan	5x5x7,dx=8mm dy=8mm dz=5mm,Very fast
Phantom	Validation plane
Device Position	Body Front
Band	PCS 1900
Channels	Middle
Signal	TDMA (Crest factor: 8.0)

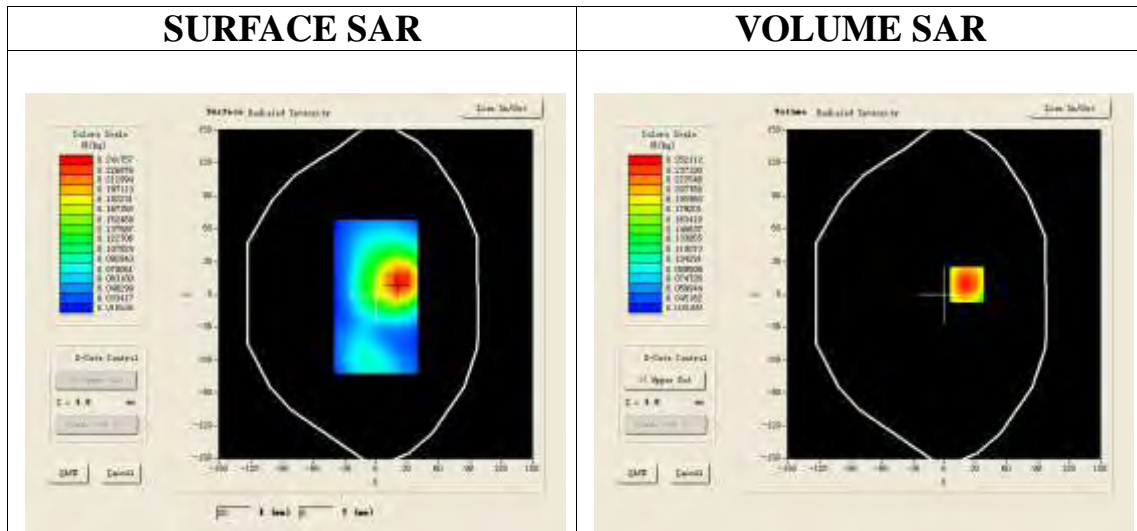

Maximum location: X=22.00, Y=9.00

SAR 10g (W/Kg)	0.161248
SAR 1g (W/Kg)	0.263286

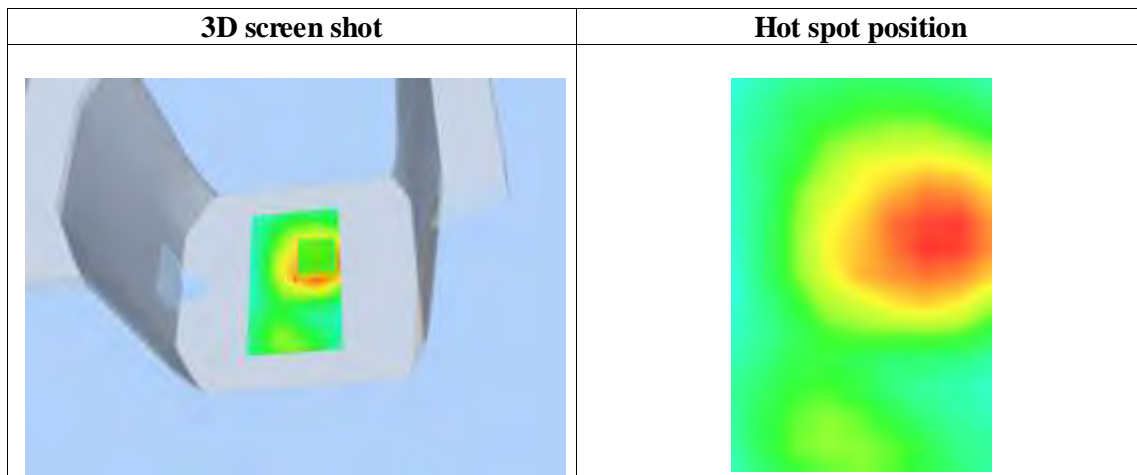
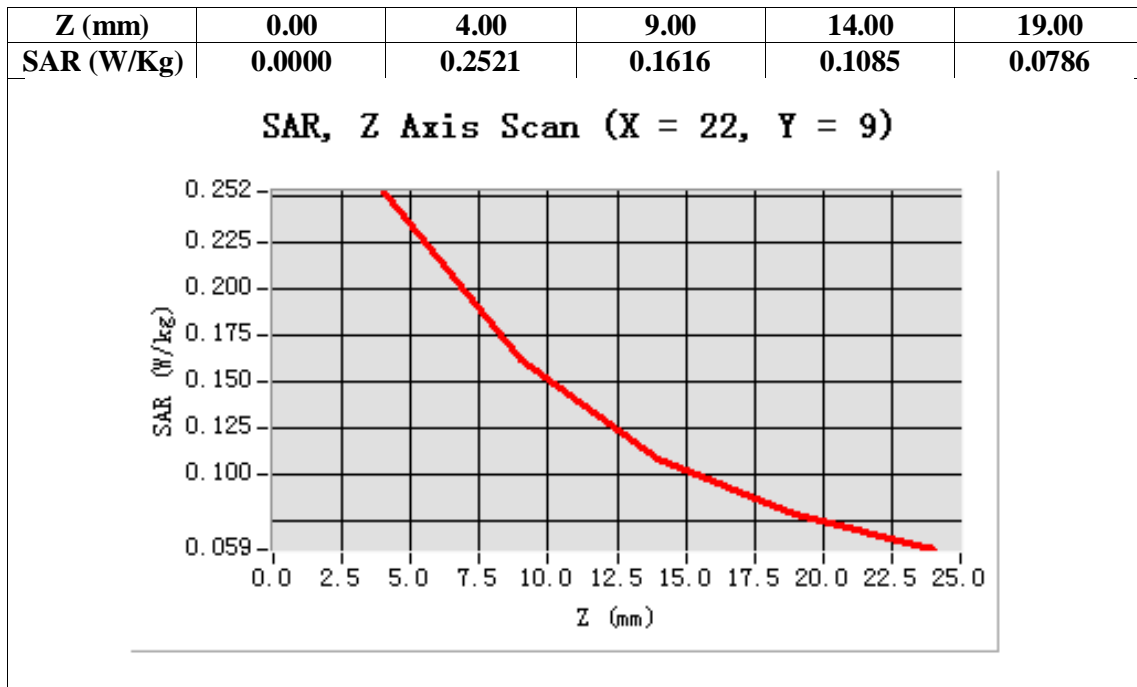



Test Laboratory: AGC Lab  
WCDMA Band II Mid-Touch-Left (RMC)  
DUT: Mobile Phone; Type: QUE 5.0

Date: July 24,2014

Communication System: UMTS; Communication System Band: Band II UTRA/FDD ;Duty Cycle:1:1;Conv.F=4.51  
Frequency: 1880 MHz; Medium parameters used: f = 1900 MHz;  $\sigma = 1.42$  mho/m;  $\epsilon_r = 40.41$ ;  $\rho = 1000$  kg/m<sup>3</sup> ;  
Phantom section: Left Section  
Ambient temperature (°C):21, Liquid temperature (°C):21

SATIMO Configuration:

- Probe: SSE5; Calibrated: 01/12/2014; Serial No.:SN 22/12 EP159
- Sensor-Surface: 4mm (Mechanical Surface Detection)
- Phantom: Flat Phantom; Type: Elliptical Phantom
- Measurement SW: OpenSAR V4\_02\_01

Configuration/ WCDMA Band II Mid-Touch-Left/Area Scan: Measurement grid: dx=8mm, dy=8mm  
Configuration/ WCDMA Band II Mid-Touch-Left/Zoom Scan: Measurement grid:  
dx=8mm,dy=8mm,dz=5mm;

Area Scan	sam_direct_droit2_surf8mm.txt
ZoomScan	5x5x7,dx=8mm dy=8mm dz=5mm,Very fast
Phantom	Left head
Device Position	Cheek
Band	WCDMA Band II
Channels	Middle
Signal	TDMA (Crest factor: 1.0)

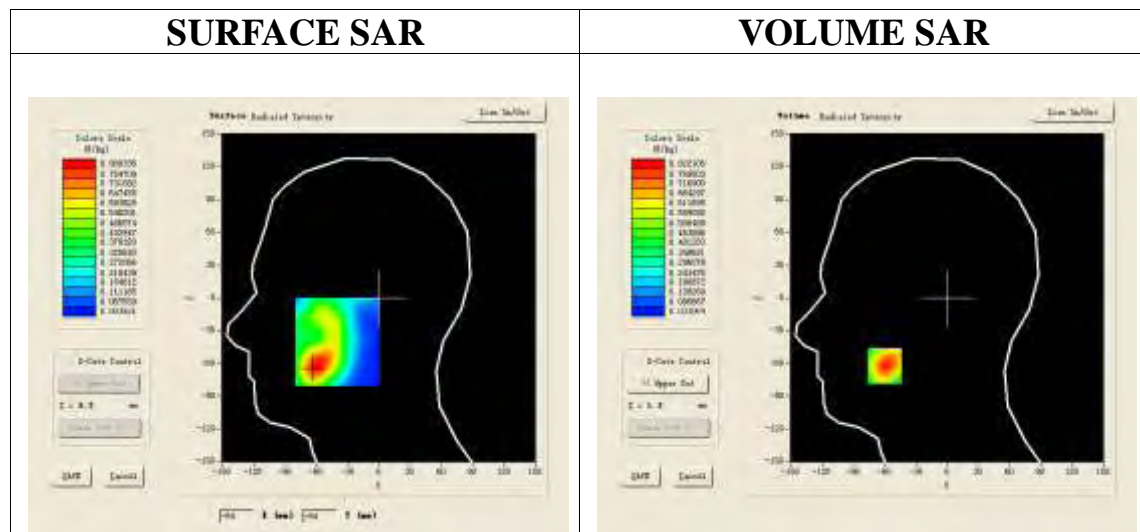

Maximum location: X=-60.00, Y=-62.00

SAR 10g (W/Kg)	0.436593
SAR 1g (W/Kg)	0.775731

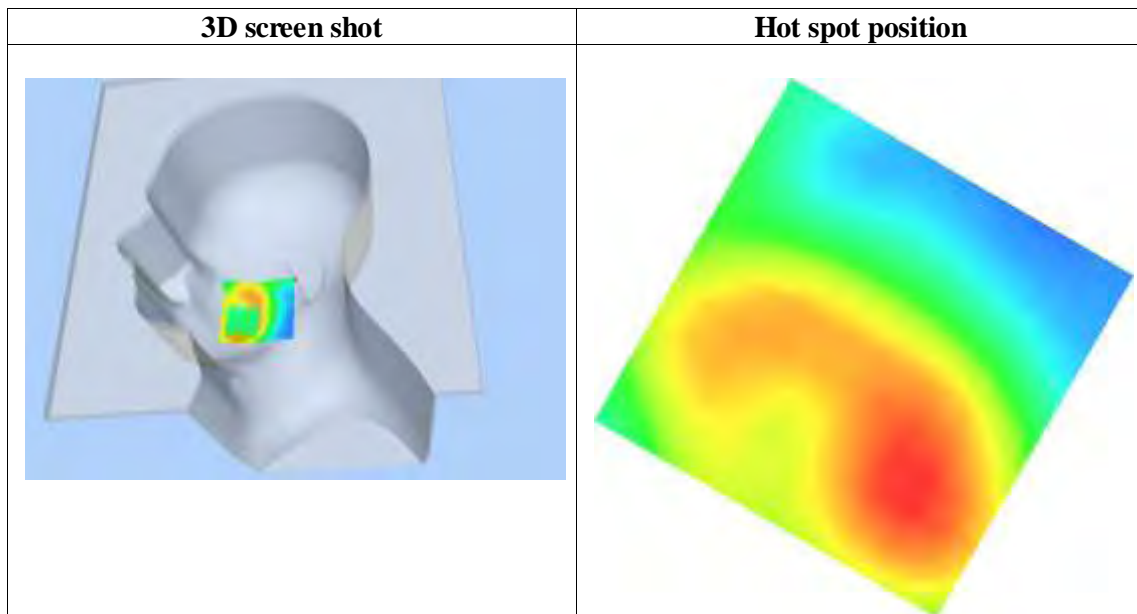
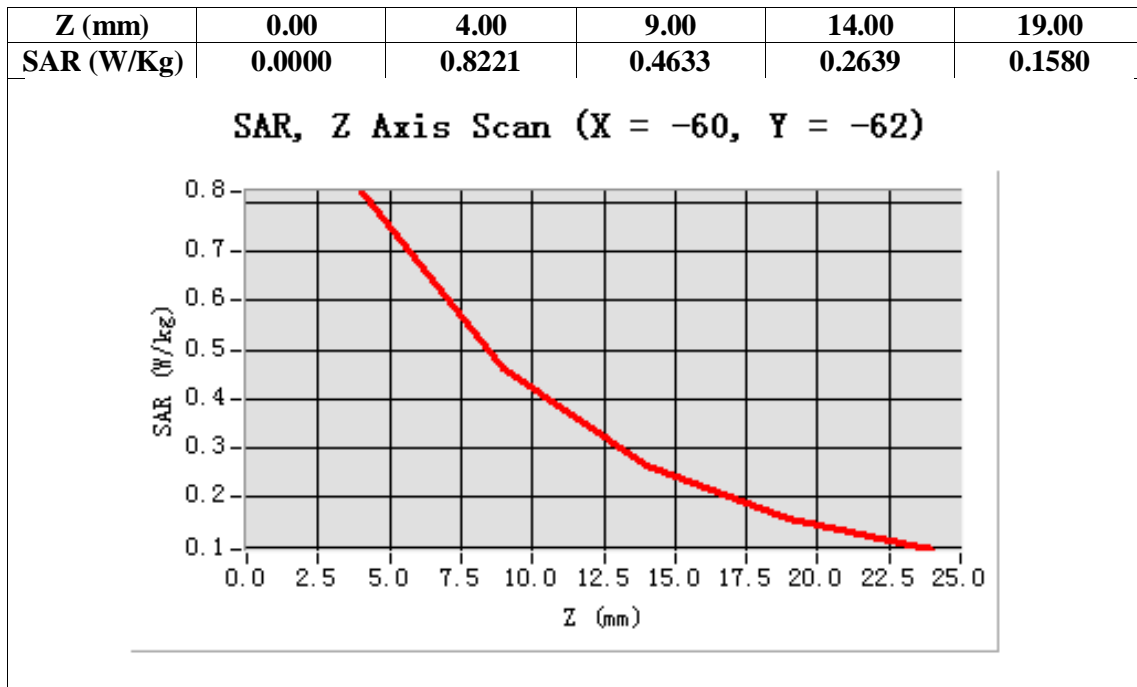

Test Laboratory: AGC Lab  
WCDMA Band II Mid-Tilt-Left (RMC)  
DUT: Mobile Phone; Type: QUE 5.0

Date: July 24,2014

Communication System: UMTS; Communication System Band: Band II UTRA/FDD ;Duty Cycle:1:1; Conv.F=4.51  
Frequency: 1880 MHz; Medium parameters used:  $f = 1900$  MHz;  $\sigma = 1.42$  mho/m; $\epsilon_r = 40.41$ ;  $\rho = 1000$  kg/m<sup>3</sup> ;  
Phantom section: Left Section  
Ambient temperature (°C):21, Liquid temperature (°C):21

SATIMO Configuration:

- Probe: SSE5; Calibrated: 01/12/2014; Serial No.:SN 22/12 EP159
- Sensor-Surface: 4mm (Mechanical Surface Detection)
- Phantom: Flat Phantom; Type: Elliptical Phantom
- Measurement SW: OpenSAR V4\_02\_01

Configuration/ WCDMA Band II Mid-Tilt-Left/Area Scan: Measurement grid: dx=8mm, dy=8mm  
Configuration/ WCDMA Band II Mid-Tilt-Left/Zoom Scan: Measurement grid: dx=8mm, dy=8mm, dz=5mm;

Area Scan	sam_direct_droit2_surf8mm.txt
ZoomScan	5x5x7,dx=8mm dy=8mm dz=5mm,Very fast
Phantom	Left head
Device Position	Tilt
Band	WCDMA Band II
Channels	Middle
Signal	TDMA (Crest factor: 1.0)

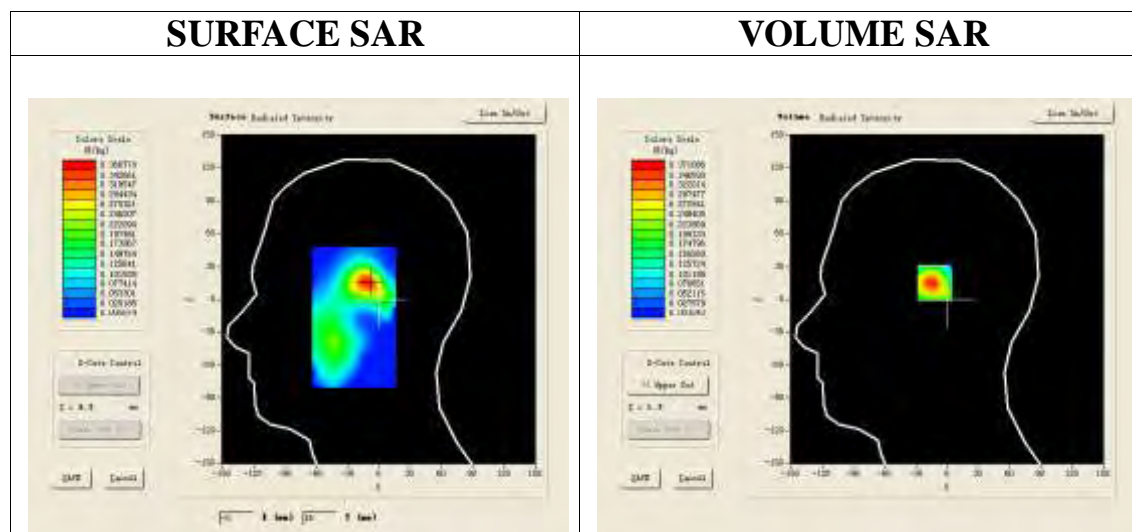

Maximum location: X=-10.00, Y=16.00

SAR 10g (W/Kg)	0.184621
SAR 1g (W/Kg)	0.345739

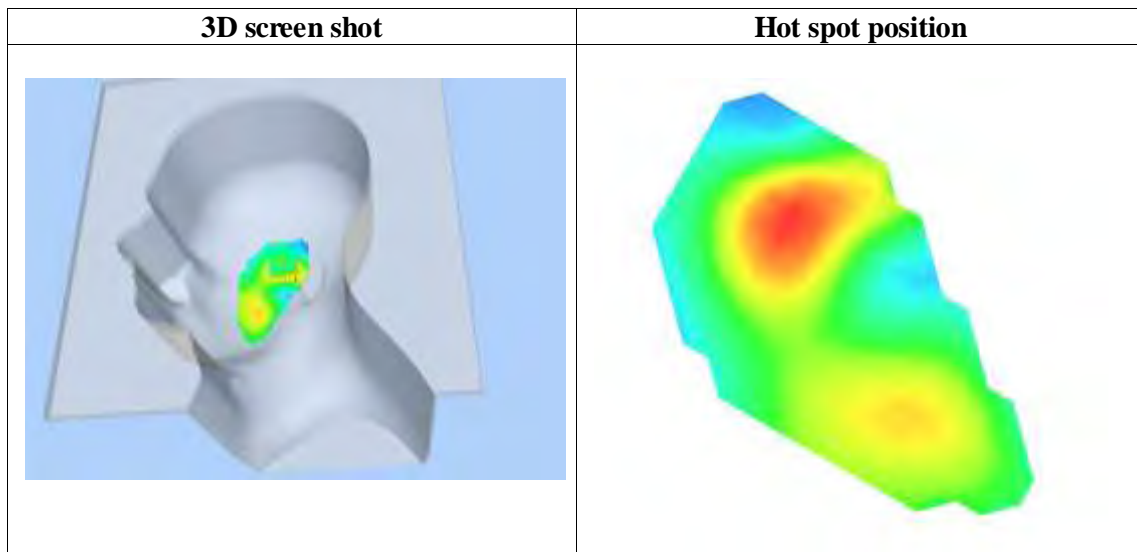
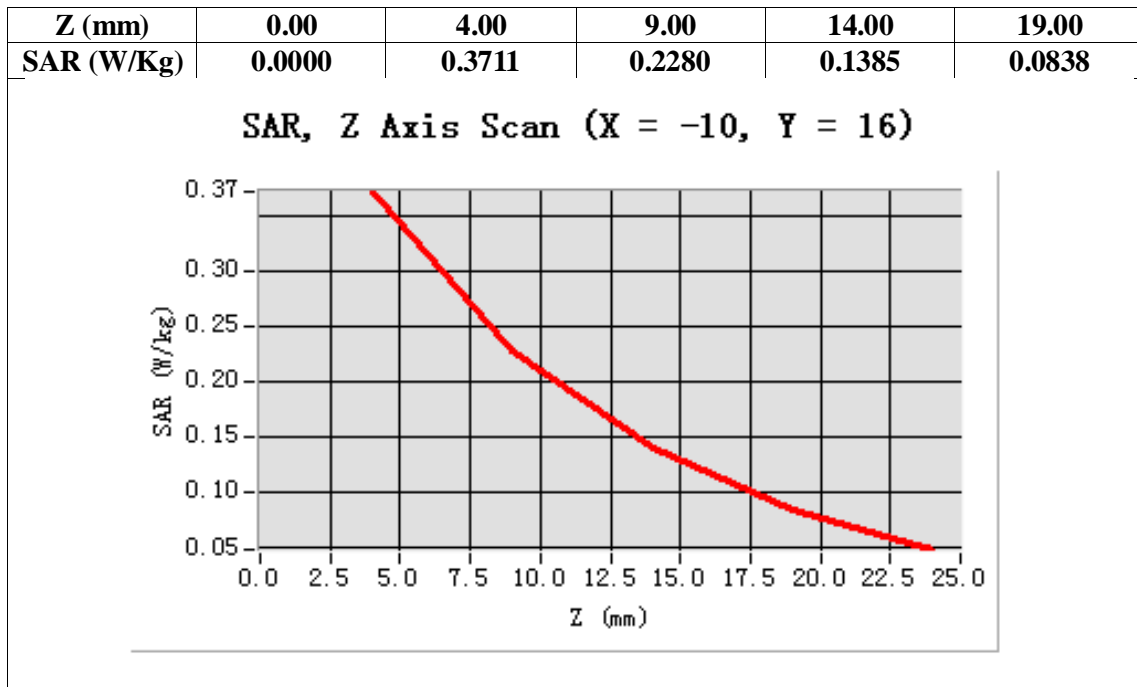

**Test Laboratory: AGC Lab**  
**WCDMA Band II Low-Touch-Right (RMC)**  
**DUT: Mobile Phone; Type: QUE 5.0**

**Date: July 24,2014**

Communication System: UMTS; Communication System Band: Band II UTRA/FDD ;Duty Cycle:1:1; Conv.F=4.51  
Frequency: 1852.4MHz; Medium parameters used:  $f = 1900$  MHz;  $\sigma = 1.39$  mho/m;  $\epsilon_r = 40.33$ ;  $\rho = 1000$  kg/m<sup>3</sup> ;  
Phantom section: Right Section  
Ambient temperature (°C):21, Liquid temperature (°C):21

SATIMO Configuration:

- Probe: SSE5; Calibrated: 01/12/2014; Serial No.:SN 22/12 EP159
- Sensor-Surface: 4mm (Mechanical Surface Detection)
- Phantom: Flat Phantom; Type: Elliptical Phantom
- Measurement SW: OpenSAR V4\_02\_01

**Configuration/ WCDMA band II Low-Touch-Right/Area Scan: Measurement grid: dx=8mm, dy=8mm**  
**Configuration/ WCDMA band II Low-Touch-Right/Zoom Scan: Measurement grid: dx=8mm, dy=8mm, dz=5mm;**

<b>Area Scan</b>	sam_direct_droit2_surf8mm.txt
<b>ZoomScan</b>	5x5x7,dx=8mm dy=8mm dz=5mm,Very fast
<b>Phantom</b>	Right head
<b>Device Position</b>	Cheek
<b>Band</b>	WCDMA band II
<b>Channels</b>	Low
<b>Signal</b>	TDMA (Crest factor: 1.0)

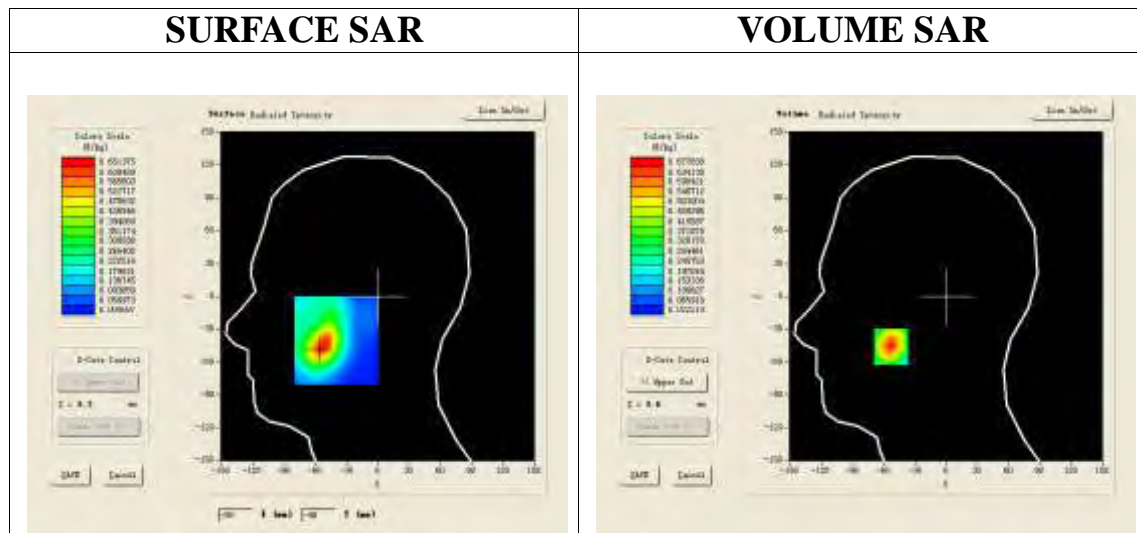

**Maximum location: X=-53.00, Y=-46.00**

<b>SAR 10g (W/Kg)</b>	0.365742
<b>SAR 1g (W/Kg)</b>	0.634673

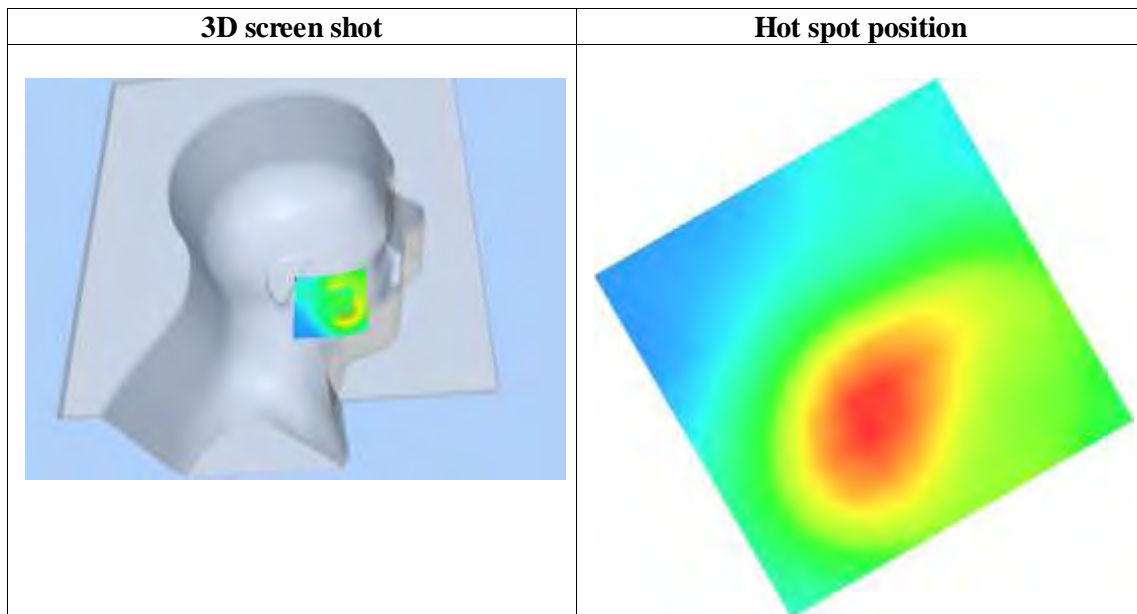
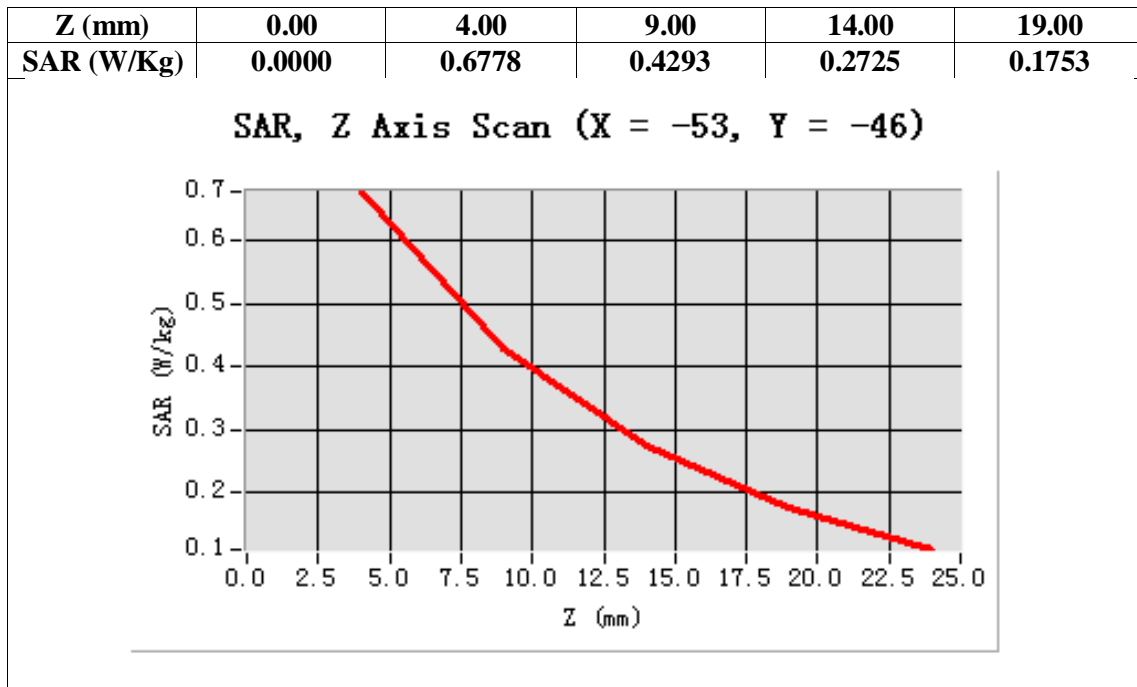

Test Laboratory: AGC Lab  
WCDMA Band II Mid-Touch-Right (RMC)  
DUT: Mobile Phone; Type: QUE 5.0

Date: July 24,2014

Communication System: UMTS; Communication System Band: Band II UTRA/FDD ;Duty Cycle:1:1; Conv.F=4.51  
Frequency: 1880 MHz; Medium parameters used: f = 1900 MHz;  $\sigma$ = 1.42 mho/m;  $\epsilon_r$  =40.41;  $\rho$ = 1000 kg/m<sup>3</sup> ;  
Phantom section: Right Section  
Ambient temperature (°C):21, Liquid temperature (°C):21

SATIMO Configuration:

- Probe: SSE5; Calibrated: 01/12/2014; Serial No.:SN 22/12 EP159
- Sensor-Surface: 4mm (Mechanical Surface Detection)
- Phantom: Flat Phantom; Type: Elliptical Phantom
- Measurement SW: OpenSAR V4\_02\_01

Configuration/ WCDMA band II Mid-Touch-Right/Area Scan: Measurement grid: dx=8mm, dy=8mm  
Configuration/ WCDMA band II Mid-Touch-Right/Zoom Scan: Measurement grid: dx=8mm, dy=8mm, dz=5mm;

Area Scan	sam_direct_droit2_surf8mm.txt
ZoomScan	5x5x7,dx=8mm dy=8mm dz=5mm,Very fast
Phantom	Right head
Device Position	Cheek
Band	WCDMA band II
Channels	Middle
Signal	TDMA (Crest factor: 1.0)

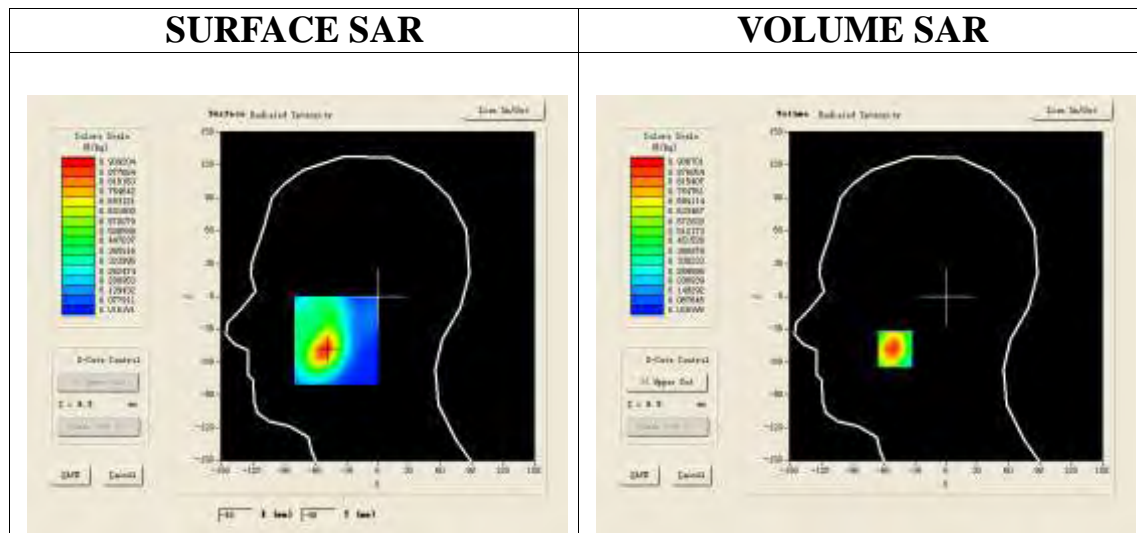

Maximum location: X=-49.00, Y=-48.00

SAR 10g (W/Kg)	0.504632
SAR 1g (W/Kg)	0.873897

Z (mm)	0.00	4.00	9.00	14.00	19.00
SAR (W/Kg)	0.0000	0.9367	0.5936	0.3790	0.2473

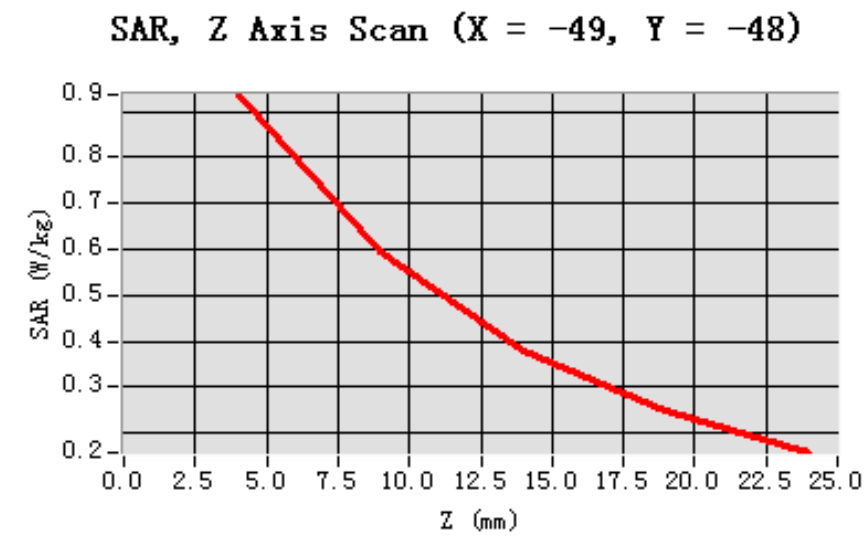

3D screen shot	Hot spot position
<p>A 3D rendering of a human head model. A small, rectangular area on the side of the head, near the ear, is highlighted with a color gradient from blue to red, indicating a localized area of high SAR exposure.</p>	<p>A 2D heatmap visualization of the SAR distribution. The color scale ranges from blue (low SAR) to red (high SAR). A prominent red and yellow region is centered in the middle of the plot, representing the 'hot spot' position.</p>



Test Laboratory: AGC Lab  
WCDMA Band II High-Touch-Right (RMC)  
DUT: Mobile Phone; Type: QUE 5.0

Date: July 24,2014

Communication System: UMTS; Communication System Band: Band II UTRA/FDD ;Duty Cycle:1:1; Conv.F=4.51  
Frequency: 1907.6 MHz; Medium parameters used:  $f = 1900$  MHz;  $\sigma = 1.40$  mho/m;  $\epsilon_r = 40.65$ ;  $\rho = 1000$  kg/m<sup>3</sup> ;  
Phantom section: Right Section  
Ambient temperature (°C):21, Liquid temperature (°C):21

SATIMO Configuration:

- Probe: SSE5; Calibrated: 01/12/2014; Serial No.:SN 22/12 EP159
- Sensor-Surface: 4mm (Mechanical Surface Detection)
- Phantom: Flat Phantom; Type: Elliptical Phantom
- Measurement SW: OpenSAR V4\_02\_01

Configuration/ WCDMA band II High-Touch-Right/Area Scan: Measurement grid: dx=8mm, dy=8mm  
Configuration/ WCDMA band II High-Touch-Right/Zoom Scan: Measurement grid: dx=8mm, dy=8mm, dz=5mm;

Area Scan	sam_direct_droit2_surf8mm.txt
ZoomScan	5x5x7,dx=8mm dy=8mm dz=5mm,Very fast
Phantom	Right head
Device Position	Cheek
Band	WCDMA band II
Channels	High
Signal	TDMA (Crest factor: 1.0)

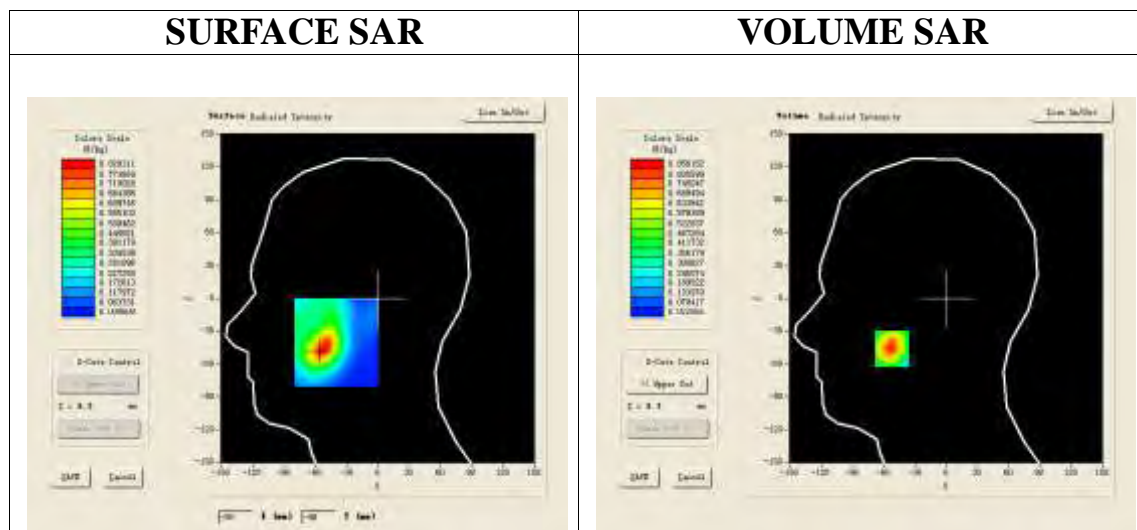

Maximum location: X=-52.00, Y=-46.00

SAR 10g (W/Kg)	0.454326
SAR 1g (W/Kg)	0.793768

Z (mm)	0.00	4.00	9.00	14.00	19.00
SAR (W/Kg)	0.0000	0.8562	0.5345	0.3336	0.2106

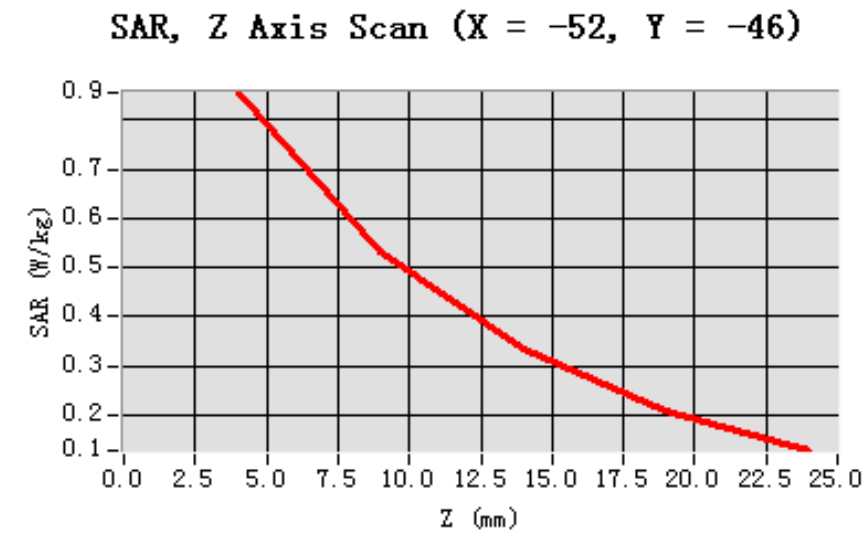

**3D screen shot**



**Hot spot position**

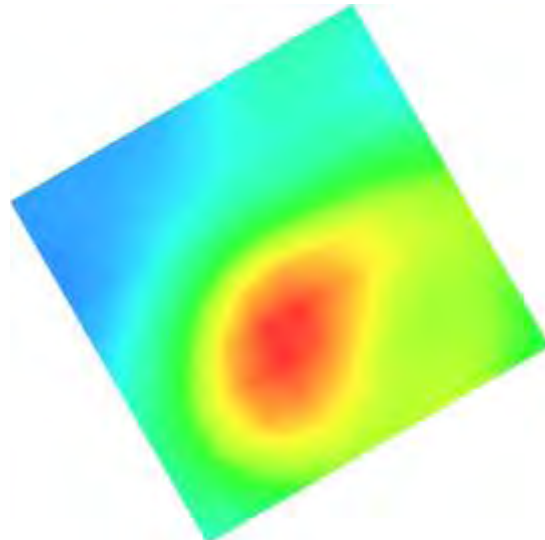

Test Laboratory: AGC Lab  
WCDMA Band II Mid-Tilt-Right <RMC>  
DUT: Mobile Phone; Type: QUE 5.0

Date: July 24,2014

Communication System: UMTS; Communication System Band: Band II UTRA/FDD ;Duty Cycle:1:1; Conv.F=4.51  
Frequency: 1880 MHz; Medium parameters used: f = 1900 MHz;  $\sigma = 1.42$  mho/m;  $\epsilon_r = 40.41$ ;  $\rho = 1000$  kg/m<sup>3</sup> ;  
Phantom section: Right Section  
Ambient temperature (°C):21, Liquid temperature (°C):21

SATIMO Configuration:

- Probe: SSE5; Calibrated: 01/12/2014; Serial No.:SN 22/12 EP159
- Sensor-Surface: 4mm (Mechanical Surface Detection)
- Phantom: Flat Phantom; Type: Elliptical Phantom
- Measurement SW: OpenSAR V4\_02\_01

Configuration/PCS1900 Mid-Tilt-Right/Area Scan: Measurement grid: dx=8mm, dy=8mm  
Configuration/PCS1900 Mid-Tilt-Right/Zoom Scan: Measurement grid: dx=8mm, dy=8mm, dz=5mm;

Area Scan	sam_direct_droit2_surf8mm.txt
ZoomScan	5x5x7,dx=8mm dy=8mm dz=5mm,Very fast
Phantom	Right head
Device Position	Tilt
Band	WCDMA band II
Channels	Middle
Signal	TDMA (Crest factor: 1.0)

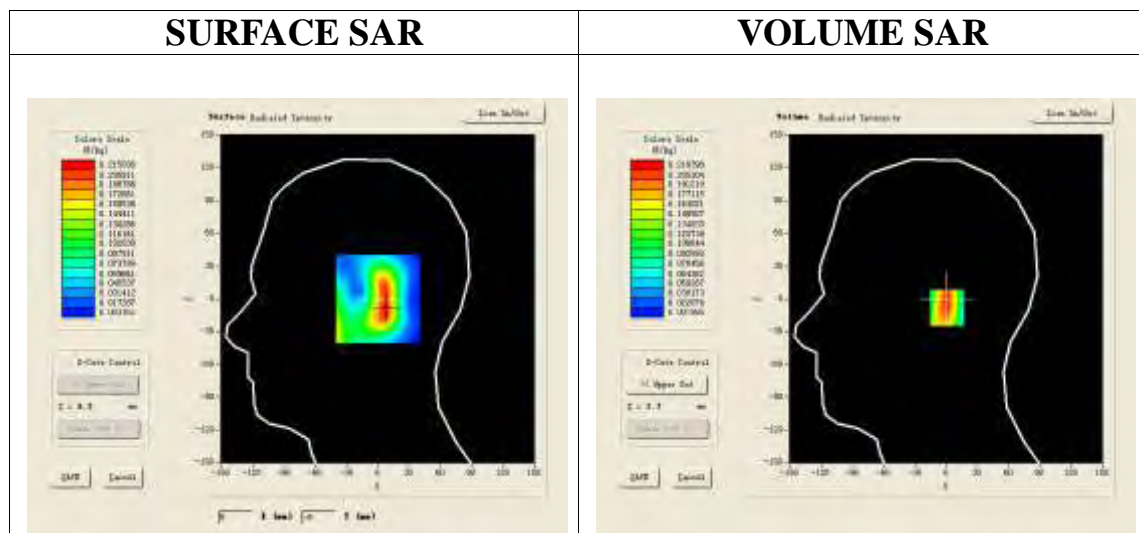

Maximum location: X=7.00, Y=-8.00

SAR 10g (W/Kg)	0.114285
SAR 1g (W/Kg)	0.203426

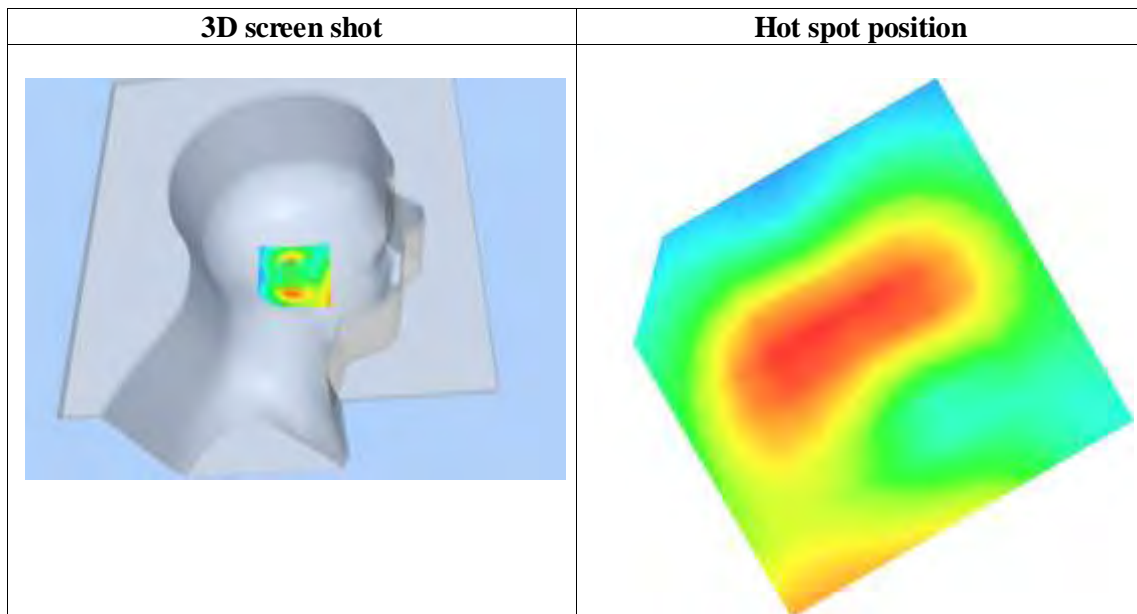
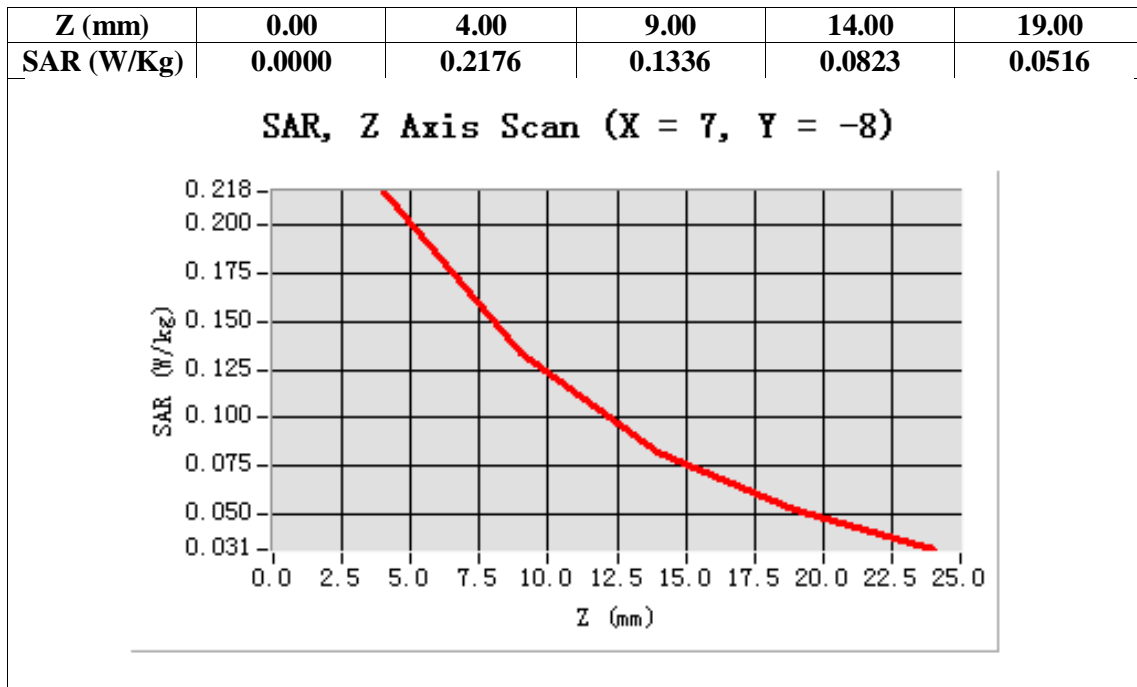

Test Laboratory: AGC Lab  
WCDMA Band II Low-Body-Towards Grounds (RMC 12.2kbps)  
DUT: Mobile Phone; Type: QUE 5.0

Date: July 24,2014

Communication System: UMTS; Communication System Band: Band II UTRA/FDD ;Duty Cycle:1:1; Conv.F=4.45  
Frequency: 1852.4 MHz; Medium parameters used:  $f = 1900$  MHz;  $\sigma=1.50$  mho/m;  $\epsilon_r=53.74$ ;  $\rho= 1000$  kg/m<sup>3</sup> ;  
Phantom section: Flat Section  
Ambient temperature (°C):21, Liquid temperature (°C):21

SATIMO Configuration:

- Probe: SSE5; Calibrated: 01/12/2014; Serial No.:SN 22/12 EP159
- Sensor-Surface: 4mm (Mechanical Surface Detection)
- Phantom: Flat Phantom; Type: Elliptical Phantom
- Measurement SW: OpenSAR V4\_02\_01

Configuration/ WCDMA band II Low-Body-back/Area Scan: Measurement grid: dx=8mm, dy=8mm  
Configuration/ WCDMA band II Low-Body-back/Zoom Scan: Measurement grid: dx=8mm, dy=8mm, dz=5mm;

Area Scan	surf_sam_plan.txt
ZoomScan	5x5x7,dx=8mm dy=8mm dz=5mm,Very fast
Phantom	Validation plane
Device Position	Body Back
Band	WCDMA band II
Channels	Low
Signal	TDMA (Crest factor: 1.0)

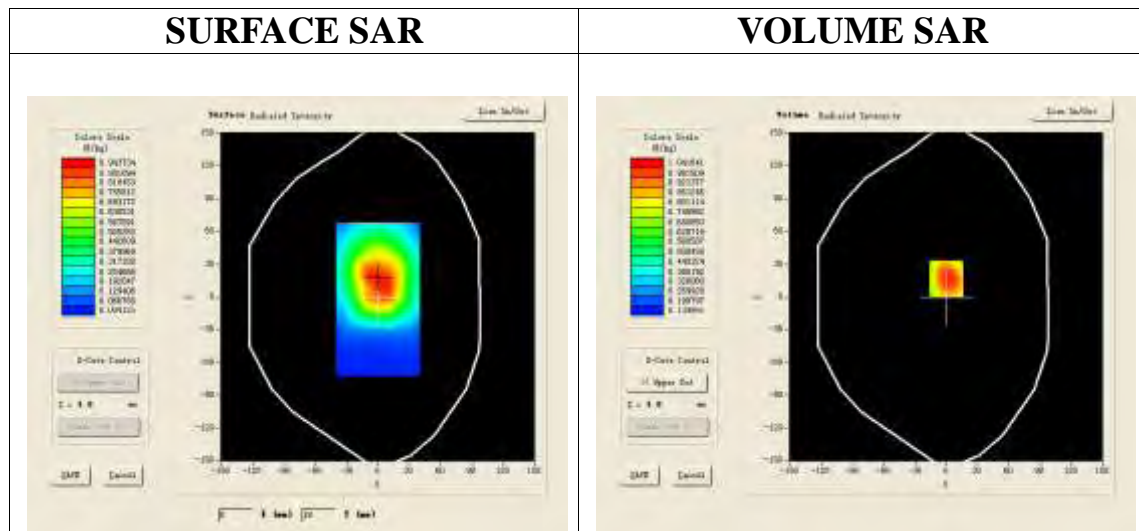

Maximum location: X=0.00, Y=17.00

SAR 10g (W/Kg)	0.701843
SAR 1g (W/Kg)	1.073741

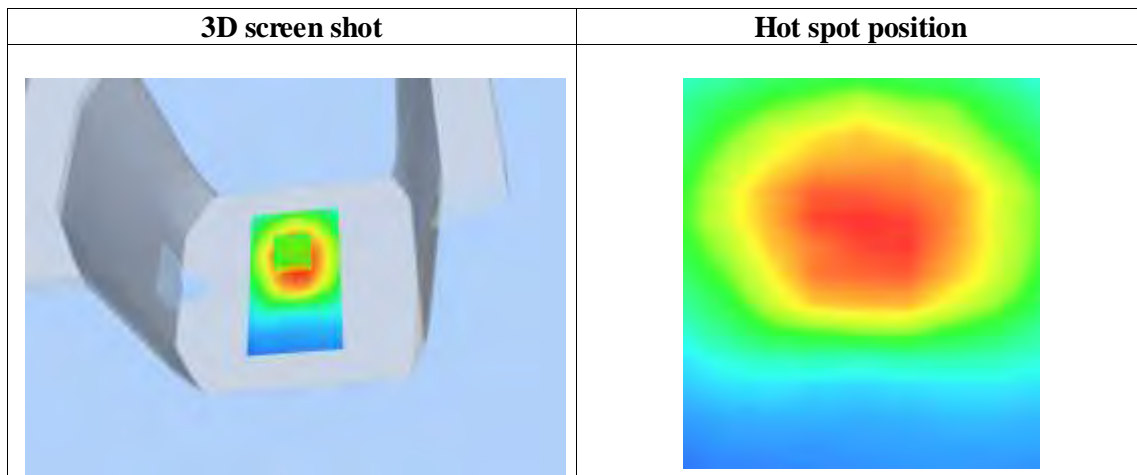
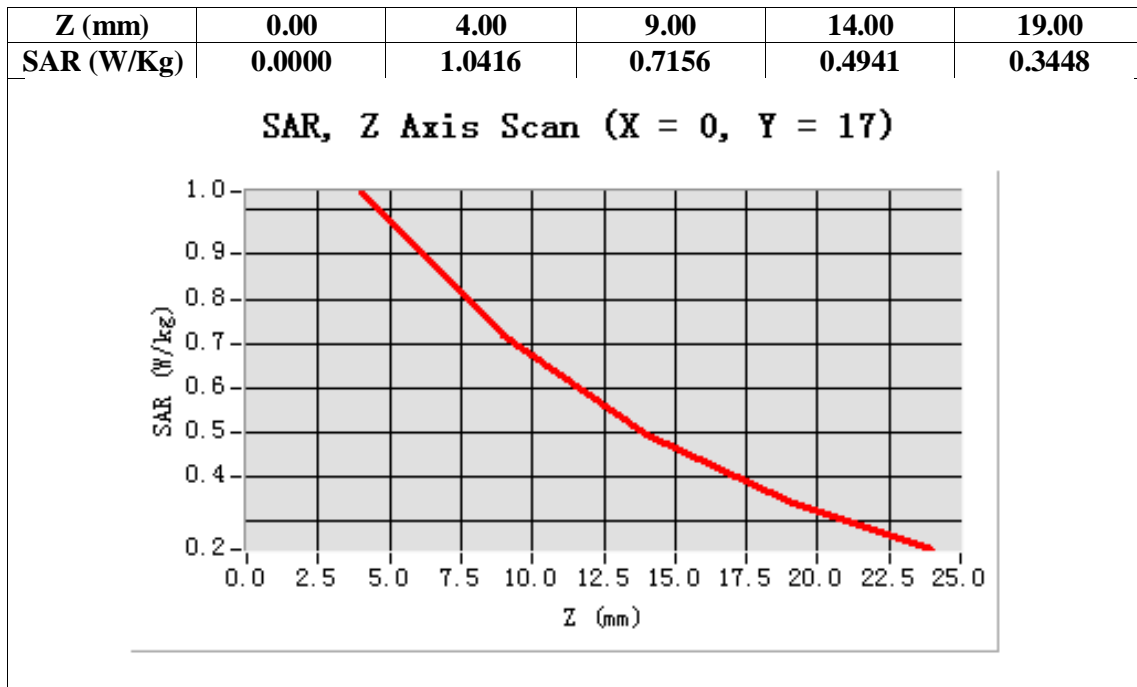

**Test Laboratory: AGC Lab**  
**WCDMA Band II Mid-Body-Towards Grounds (RMC 12.2kbps)**  
**DUT: Mobile Phone; Type: QUE 5.0**

**Date: July 24,2014**

Communication System: UMTS; Communication System Band: Band II UTRA/FDD ;Duty Cycle:1:1; Conv.F=4.45  
Frequency: 1880 MHz; Medium parameters used:  $f = 1900$  MHz;  $\sigma=1.53$  mho/m;  $\epsilon_r =53.79$ ;  $\rho= 1000$  kg/m<sup>3</sup> ;  
Phantom section: Flat Section  
Ambient temperature (°C):21, Liquid temperature (°C):21

SATIMO Configuration:

- Probe: SSE5; Calibrated: 01/12/2014; Serial No.:SN 22/12 EP159
- Sensor-Surface: 4mm (Mechanical Surface Detection)
- Phantom: Flat Phantom; Type: Elliptical Phantom
- Measurement SW: OpenSAR V4\_02\_01

**Configuration/ WCDMA band II Mid-Body-back/Area Scan: Measurement grid: dx=8mm, dy=8mm**  
**Configuration/ WCDMA band II Mid-Body-back/Zoom Scan: Measurement grid: dx=8mm, dy=8mm, dz=5mm;**

<b>Area Scan</b>	surf_sam_plan.txt
<b>ZoomScan</b>	5x5x7,dx=8mm dy=8mm dz=5mm,Very fast
<b>Phantom</b>	Validation plane
<b>Device Position</b>	Body Back
<b>Band</b>	WCDMA band II
<b>Channels</b>	Middle
<b>Signal</b>	TDMA (Crest factor: 1.0)

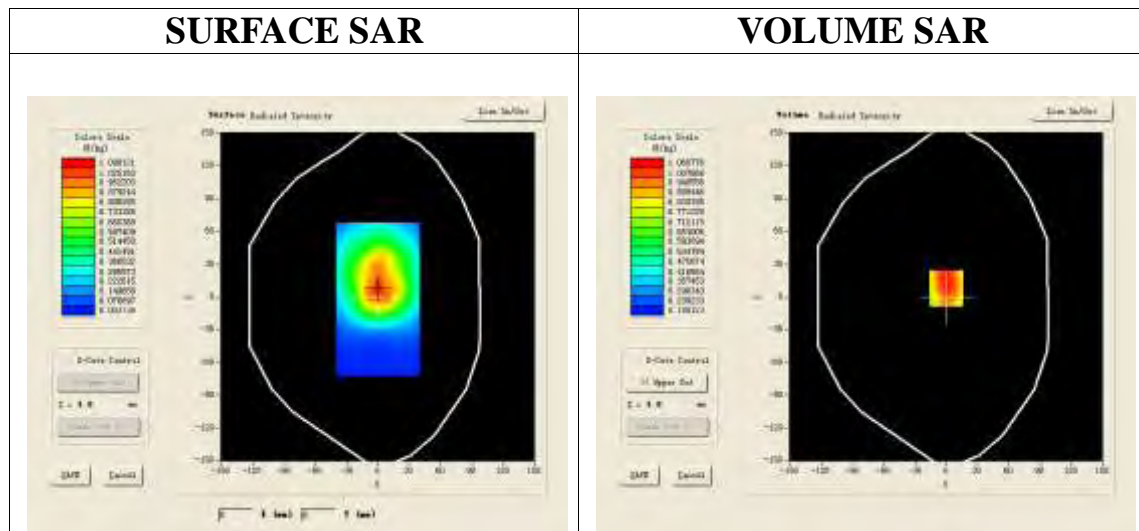

**Maximum location: X=0.00, Y=8.00**

<b>SAR 10g (W/Kg)</b>	0.755638
<b>SAR 1g (W/Kg)</b>	1.103683

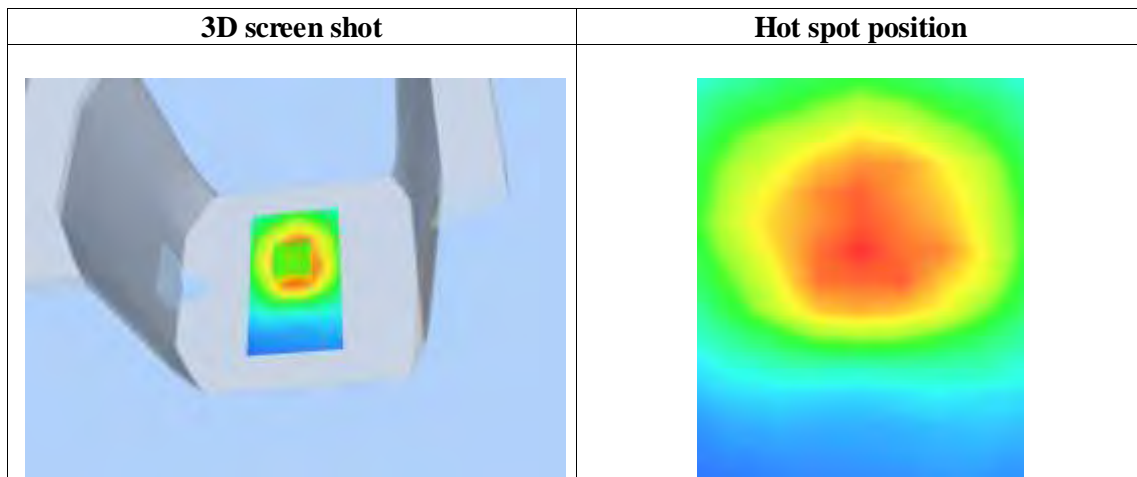
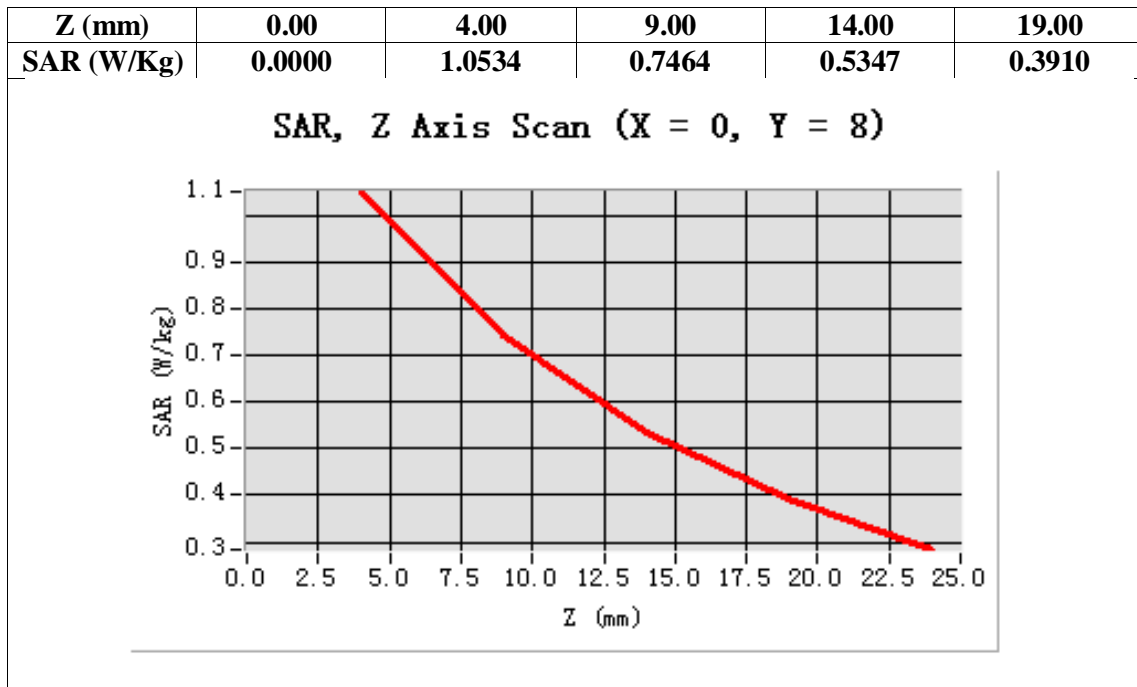



**Test Laboratory: AGC Lab**  
**WCDMA Band II High-Body-Towards Grounds (RMC 12.2kbps)**  
**DUT: Mobile Phone; Type: QUE 5.0**

**Date: July 24,2014**

Communication System: UMTS; Communication System Band: Band II UTRA/FDD ;Duty Cycle:1:1; Conv.F=4.45  
Frequency: 1907.6 MHz; Medium parameters used:  $f = 1900$  MHz;  $\sigma=1.50$  mho/m;  $\epsilon_r=53.84$ ;  $\rho= 1000$  kg/m<sup>3</sup> ;  
Phantom section: Flat Section  
Ambient temperature (°C):21, Liquid temperature (°C):21

SATIMO Configuration:

- Probe: SSE5; Calibrated: 01/12/2014; Serial No.:SN 22/12 EP159
- Sensor-Surface: 4mm (Mechanical Surface Detection)
- Phantom: Flat Phantom; Type: Elliptical Phantom
- Measurement SW: OpenSAR V4\_02\_01

**Configuration/ WCDMA band II High-Body-back/Area Scan: Measurement grid: dx=8mm, dy=8mm**  
**Configuration/ WCDMA band II High-Body-back/Zoom Scan: Measurement grid: dx=8mm, dy=8mm, dz=5mm;**

<b>Area Scan</b>	surf_sam_plan.txt
<b>ZoomScan</b>	5x5x7,dx=8mm dy=8mm dz=5mm,Very fast
<b>Phantom</b>	Validation plane
<b>Device Position</b>	Body Back
<b>Band</b>	WCDMA band II
<b>Channels</b>	High
<b>Signal</b>	TDMA (Crest factor: 1.0)

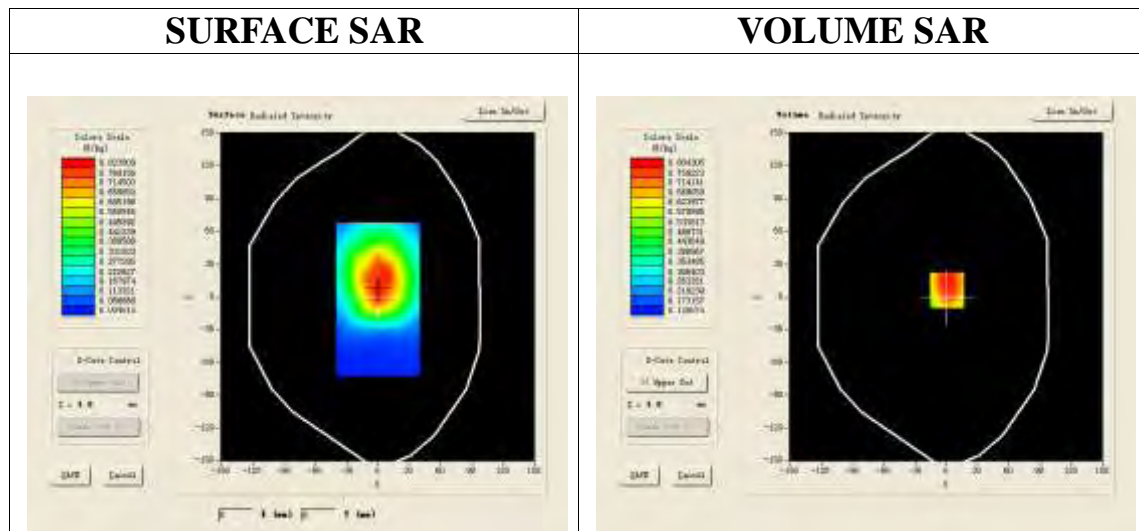

**Maximum location: X=1.00, Y=6.00**

<b>SAR 10g (W/Kg)</b>	0.597871
<b>SAR 1g (W/Kg)</b>	0.843175

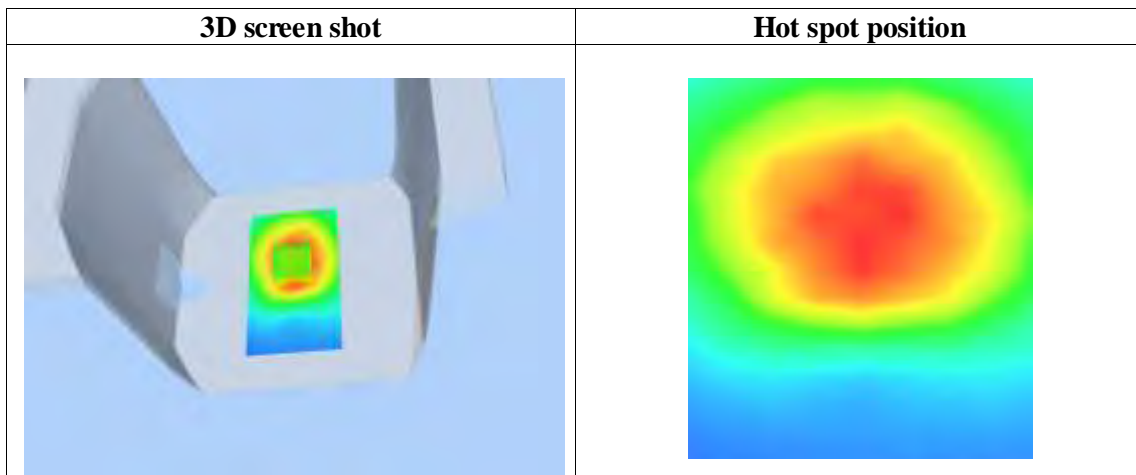
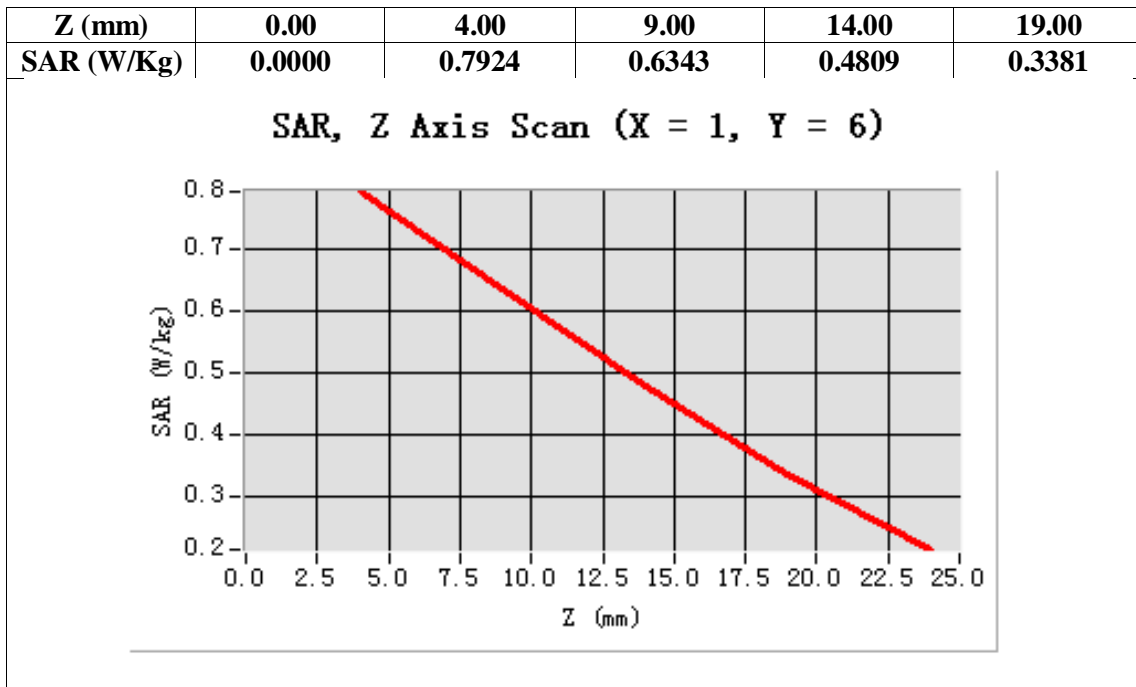

Test Laboratory: AGC Lab  
WCDMA Band II Mid-Body-Towards Phantom (RMC 12.2kbps)  
DUT: Mobile Phone; Type: QUE 5.0

Date: July 24,2014

Communication System: UMTS; Communication System Band: Band II UTRA/FDD ;Duty Cycle:1:1; Conv.F=4.45  
Frequency: 1880 MHz; Medium parameters used:  $f = 1900$  MHz;  $\sigma=1.53$  mho/m;  $\epsilon_r =53.79$ ;  $\rho= 1000$  kg/m<sup>3</sup> ;  
Phantom section: Flat Section  
Ambient temperature (°C):21, Liquid temperature (°C):21

SATIMO Configuration:

- Probe: SSE5; Calibrated: 01/12/2014; Serial No.:SN 22/12 EP159
- Sensor-Surface: 4mm (Mechanical Surface Detection)
- Phantom: Flat Phantom; Type: Elliptical Phantom
- Measurement SW: OpenSAR V4\_02\_01

Configuration/ WCDMA band II Mid-Body-Front/Area Scan: Measurement grid: dx=8mm, dy=8mm  
Configuration/ WCDMA band II Mid-Body-Front/Zoom Scan: Measurement grid: dx=8mm, dy=8mm, dz=5mm;

Area Scan	surf_sam_plan.txt
ZoomScan	5x5x7,dx=8mm dy=8mm dz=5mm,Very fast
Phantom	Validation plane
Device Position	Body Front
Band	WCDMA band II
Channels	Middle
Signal	TDMA (Crest factor: 1.0)

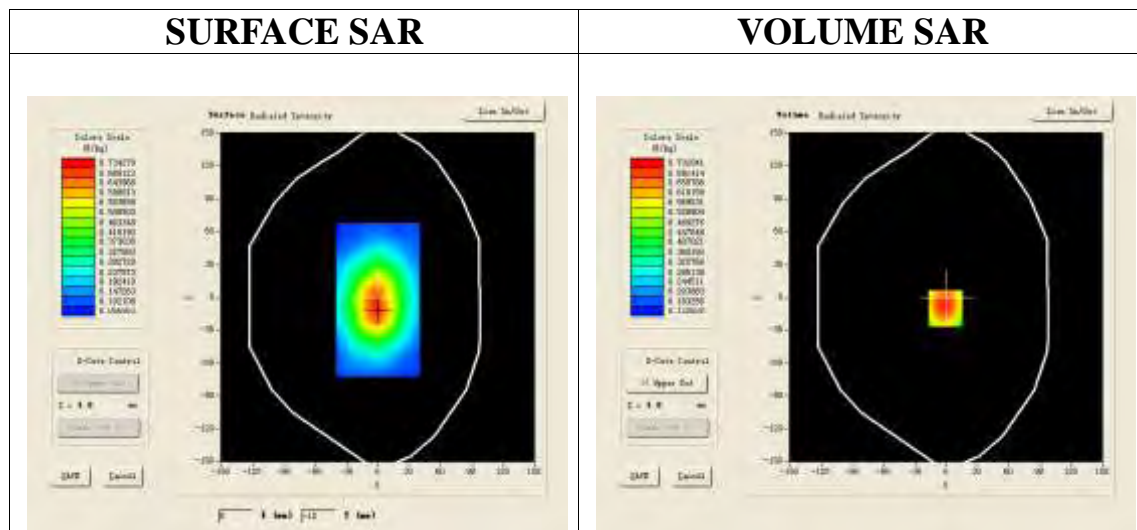

Maximum location: X=-1.00, Y=-10.00

SAR 10g (W/Kg)	0.514306
SAR 1g (W/Kg)	0.757242

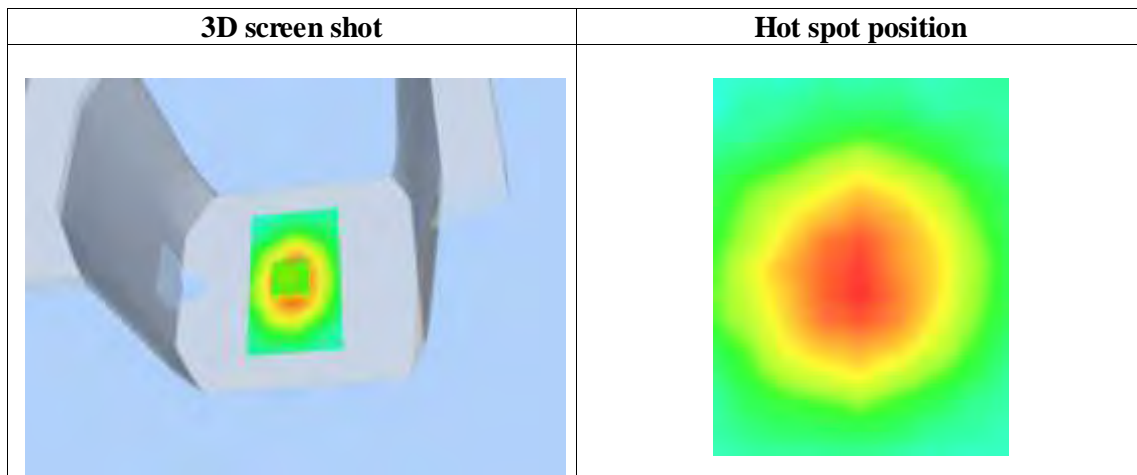
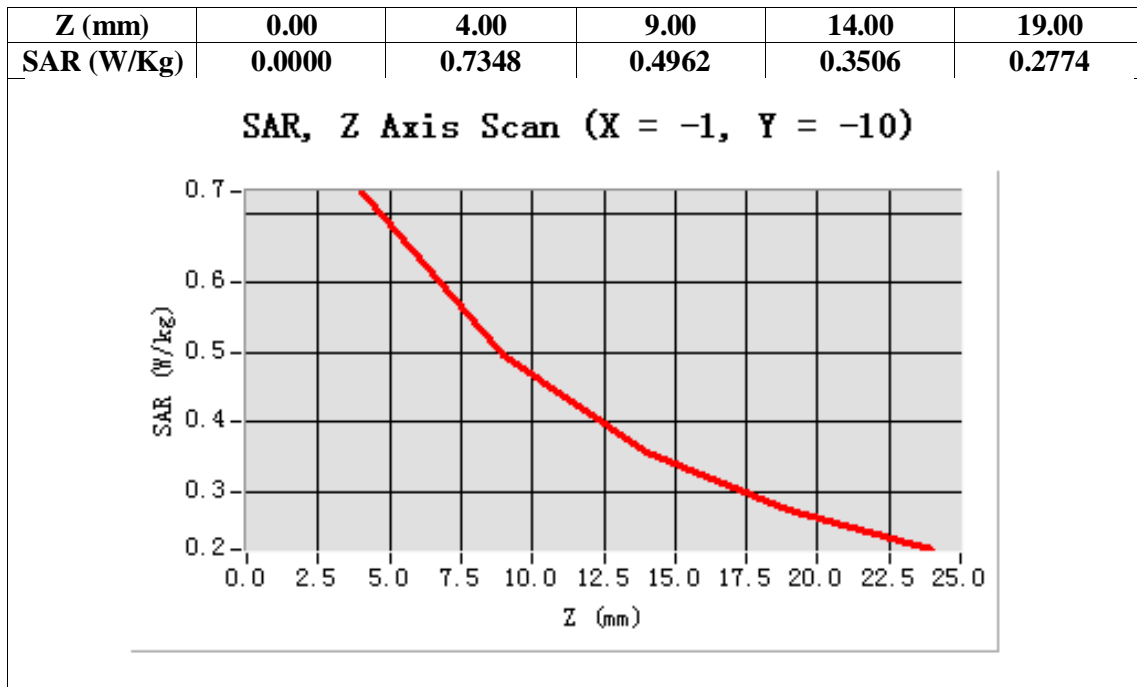

Test Laboratory: AGC Lab

Date: July 24,2014

WCDMA Band V Mid-Touch-Left (RMC)

DUT: Mobile Phone; Type: QUE 5.0

Communication System: UMTS; Communication System Band: BAND V UTRA/FDD ; Duty Cycle:1: 1; Conv.F=5.27  
Frequency: 836.6 MHz; Medium parameters used:  $f = 835$  MHz;  $\sigma=0.88$  mho/m;  $\epsilon_r =41.91$ ;  $\rho= 1000$  kg/m<sup>3</sup> ;  
Phantom section: Left Section  
Ambient temperature (°C): 21, Liquid temperature (°C): 21

SATIMO Configuration:

- Probe: SSE5; Calibrated: 01/12/2014; Serial No.:SN 22/12 EP159
- Sensor-Surface: 4mm (Mechanical Surface Detection)
- Phantom: Flat Phantom; Type: Elliptical Phantom
- Measurement SW: OpenSAR V4\_02\_01

Configuration/ WCDMA Band V Mid-Touch-Left/Area Scan (6x8x1): Measurement grid: dx=8mm, dy=8mm  
Configuration/ WCDMA Band V Mid-Touch-Left/Zoom Scan (5x5x7)/Cube 0: Measurement grid: dx=8mm, dy=8mm, dz=5mm

<b>Area Scan</b>	sam_direct_droit2_surf8mm.txt
<b>ZoomScan</b>	5x5x7,dx=8mm dy=8mm dz=5mm,Very fast
<b>Phantom</b>	Left head
<b>Device Position</b>	Cheek
<b>Band</b>	WCDMA Band V
<b>Channels</b>	Middle
<b>Signal</b>	TDMA (Crest factor: 1.0)

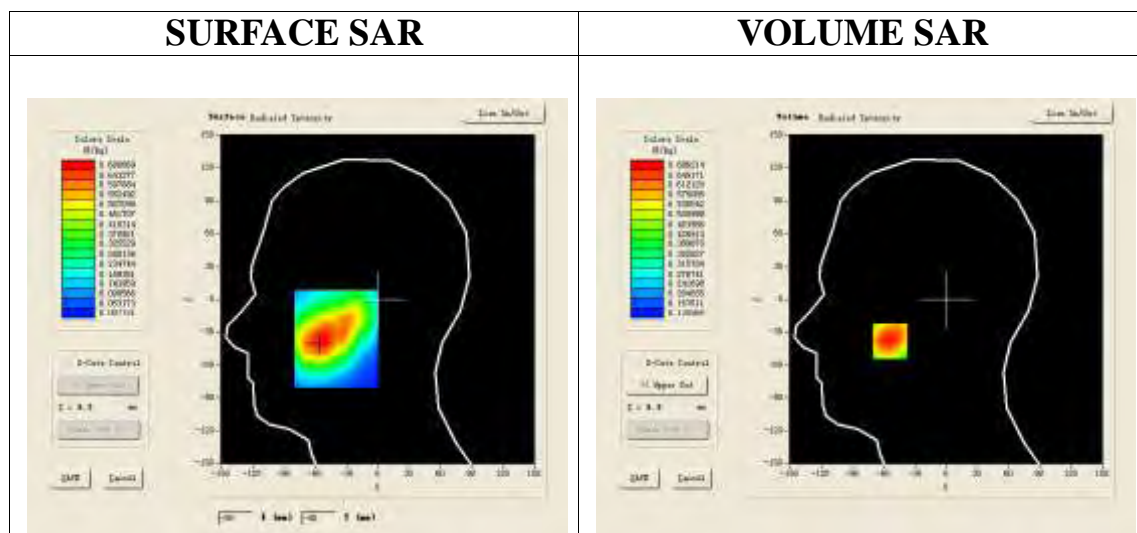

Maximum location: X=-54.00, Y=-38.00

<b>SAR 10g (W/Kg)</b>	0.485436
<b>SAR 1g (W/Kg)</b>	0.656238

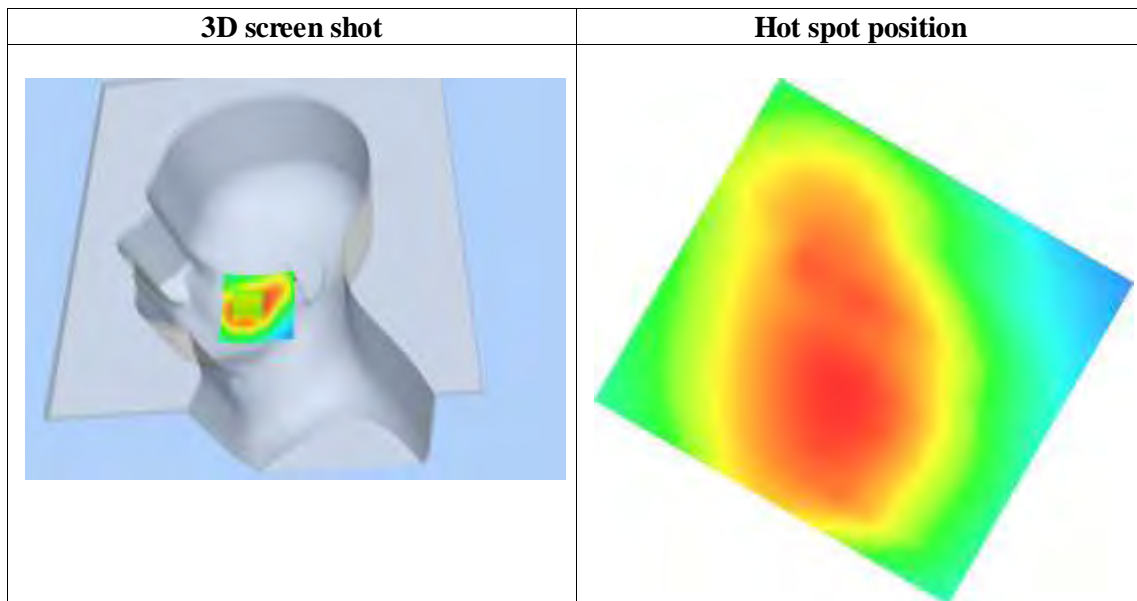
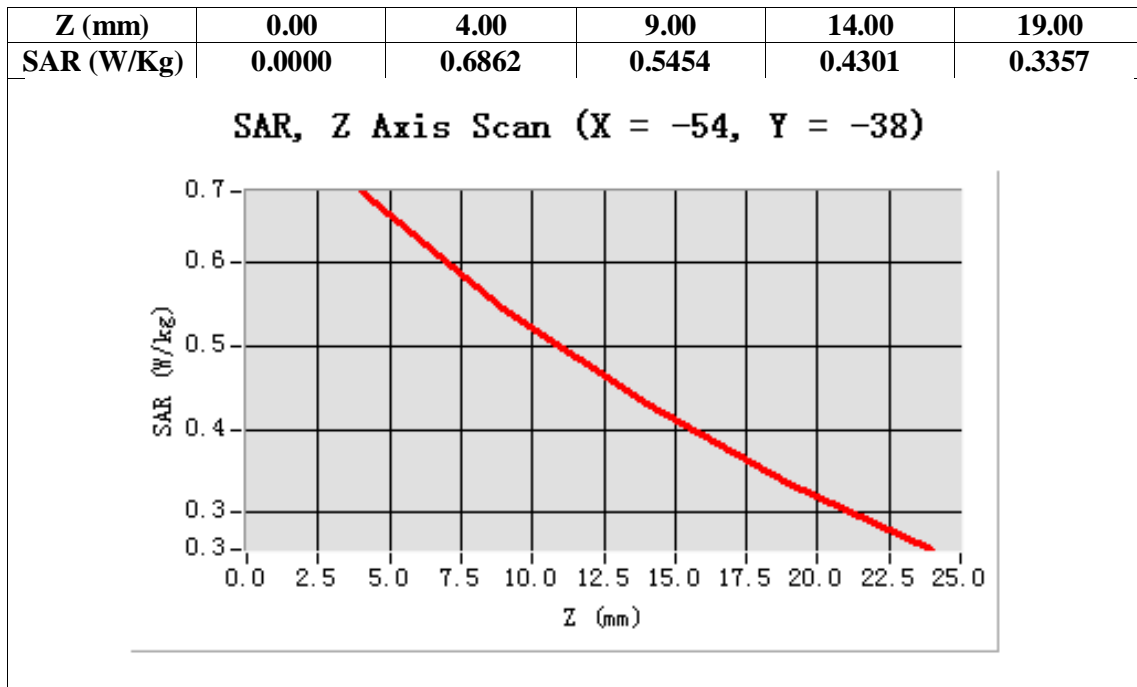

Test Laboratory: AGC Lab

Date: July 24,2014

WCDMA Band V Mid-Tilt-Left (RMC)

DUT: Mobile Phone; Type: QUE 5.0

Communication System: UMTS; Communication System Band: BAND V UTRA/FDD ; Duty Cycle:1: 1; Conv.F=5.27  
Frequency: 836.6 MHz; Medium parameters used:  $f = 835$  MHz;  $\sigma=0.88$  mho/m;  $\epsilon_r = 41.91$ ;  $\rho = 1000$  kg/m<sup>3</sup> ;  
Phantom section: Left Section  
Ambient temperature (°C): 21, Liquid temperature (°C): 21

SATIMO Configuration:

- Probe: SSE5; Calibrated: 01/12/2014; Serial No.:SN 22/12 EP159
- Sensor-Surface: 4mm (Mechanical Surface Detection)
- Phantom: Flat Phantom; Type: Elliptical Phantom
- Measurement SW: OpenSAR V4\_02\_01

Configuration/ WCDMA Band V Mid-Tilt-Left/Area Scan (6x8x1): Measurement grid: dx=8mm, dy=8mm  
Configuration/ WCDMA Band V Mid-Tilt-Left/Zoom Scan (5x5x7)/Cube 0: Measurement grid: dx=8mm, dy=8mm, dz=5mm;

<b>Area Scan</b>	sam_direct_droit2_surf8mm.txt
<b>ZoomScan</b>	5x5x7,dx=8mm dy=8mm dz=5mm,Very fast
<b>Phantom</b>	Left head
<b>Device Position</b>	Tilt
<b>Band</b>	WCDMA Band V
<b>Channels</b>	Middle
<b>Signal</b>	TDMA (Crest factor: 1.0)

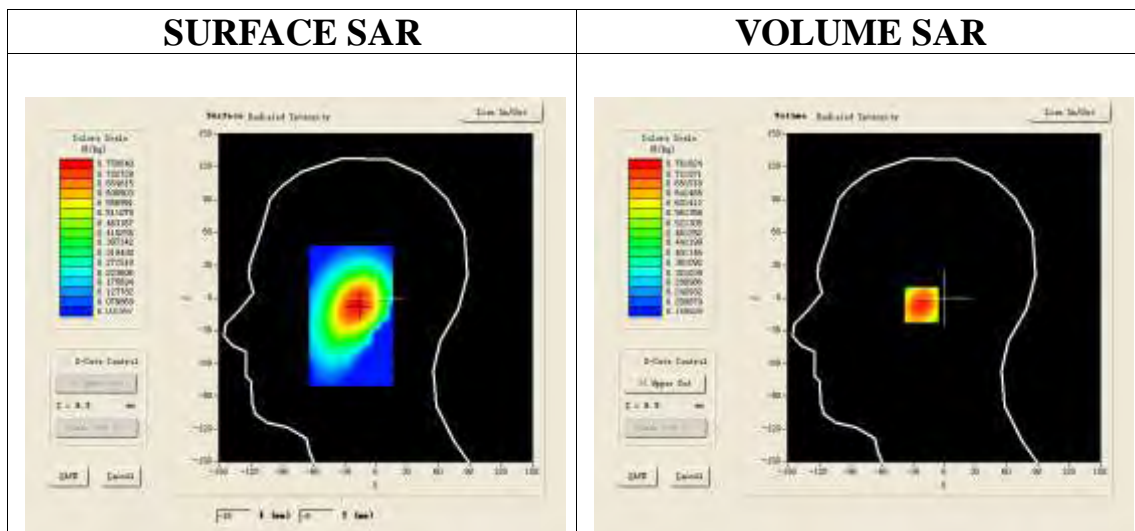

**Maximum location: X=-18.00, Y=-6.00**

<b>SAR 10g (W/Kg)</b>	0.534217
<b>SAR 1g (W/Kg)</b>	0.733085

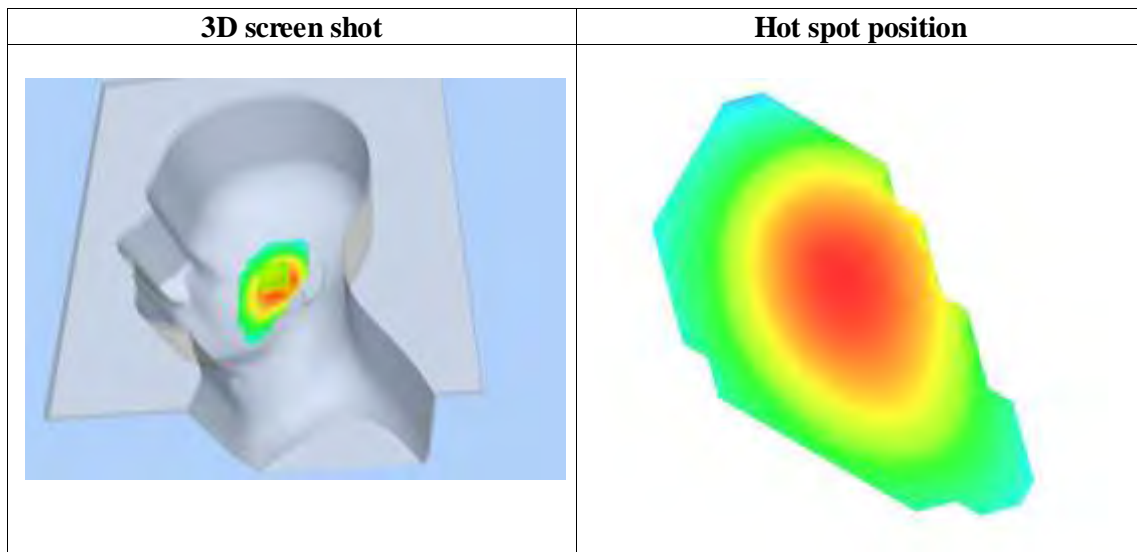
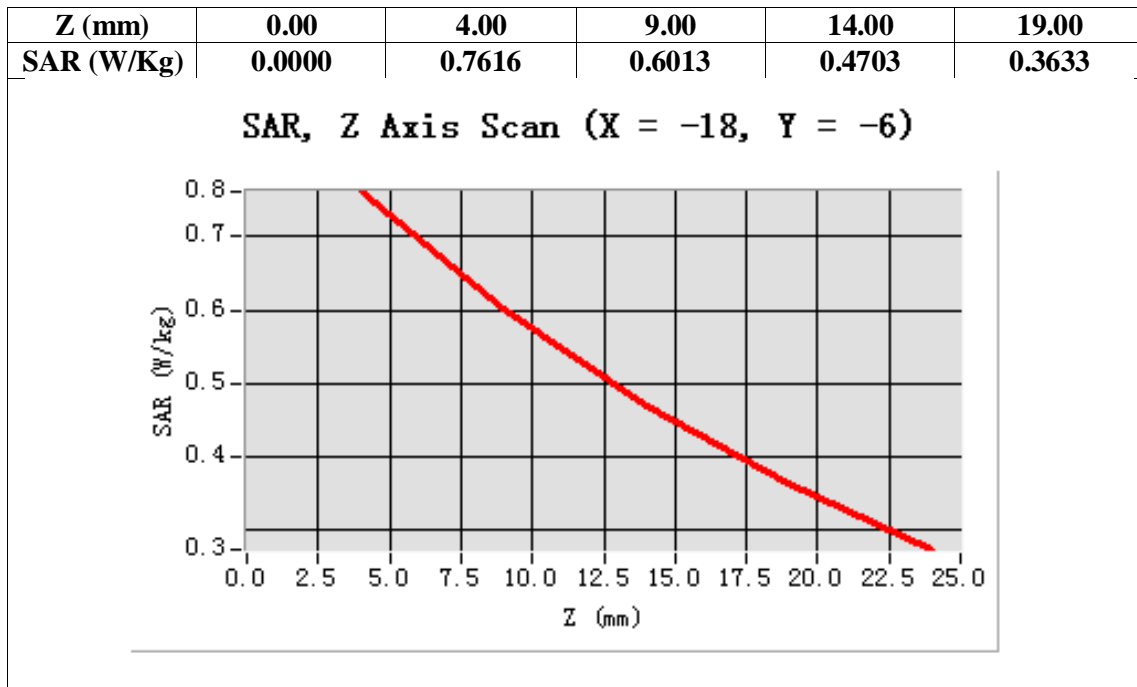



Test Laboratory: AGC Lab

Date: July 24,2014

WCDMA Band V Mid-Touch-Right (RMC)

DUT: Mobile Phone; Type: QUE 5.0

Communication System: UMTS; Communication System Band: BAND V UTRA/FDD ; Duty Cycle:1: 1; Conv.F=5.27  
Frequency: 836.6 MHz; Medium parameters used:  $f = 835$  MHz;  $\sigma=0.88$  mho/m;  $\epsilon_r = 41.91$ ;  $\rho = 1000$  kg/m<sup>3</sup> ;  
Phantom section: Right Section  
Ambient temperature (°C): 21, Liquid temperature (°C): 21

SATIMO Configuration:

- Probe: SSE5; Calibrated: 01/12/2014; Serial No.:SN 22/12 EP159
- Sensor-Surface: 4mm (Mechanical Surface Detection)
- Phantom: Flat Phantom; Type: Elliptical Phantom
- Measurement SW: OpenSAR V4\_02\_01

Configuration/ WCDMA Band V Mid-Touch-Right/Area Scan: Measurement grid: dx=8mm, dy=8mm  
Configuration/ WCDMA Band V Mid-Touch-Right/Zoom Scan: Measurement grid: dx=8mm, dy=8mm, dz=5mm;

<b>Area Scan</b>	sam_direct_droit2_surf8mm.txt
<b>ZoomScan</b>	5x5x7,dx=8mm dy=8mm dz=5mm,Very fast
<b>Phantom</b>	Right head
<b>Device Position</b>	Cheek
<b>Band</b>	WCDMA Band V
<b>Channels</b>	Middle
<b>Signal</b>	TDMA (Crest factor: 1.0)

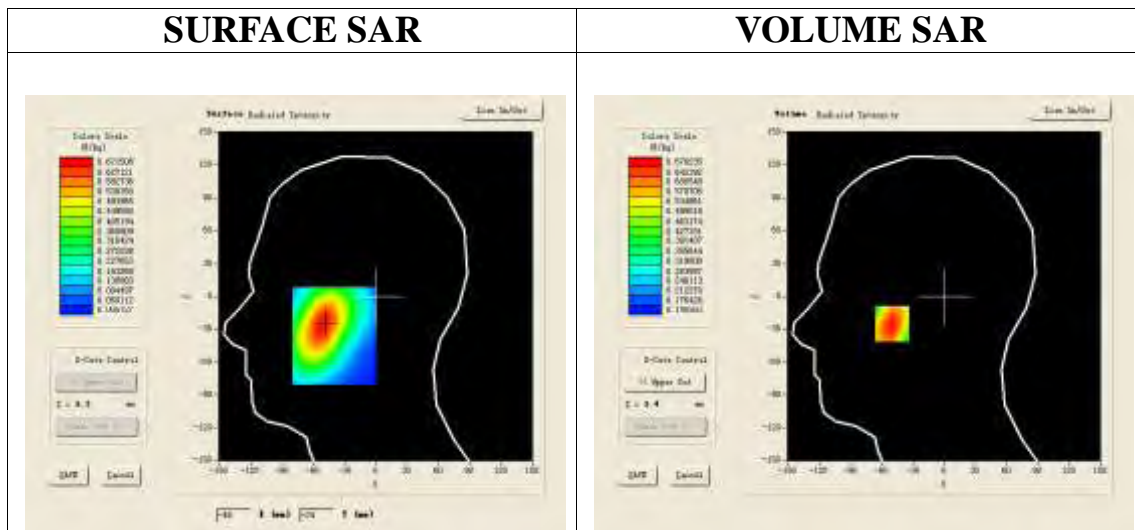

Maximum location: X=-50.00, Y=-25.00

<b>SAR 10g (W/Kg)</b>	0.481327
<b>SAR 1g (W/Kg)</b>	0.655752

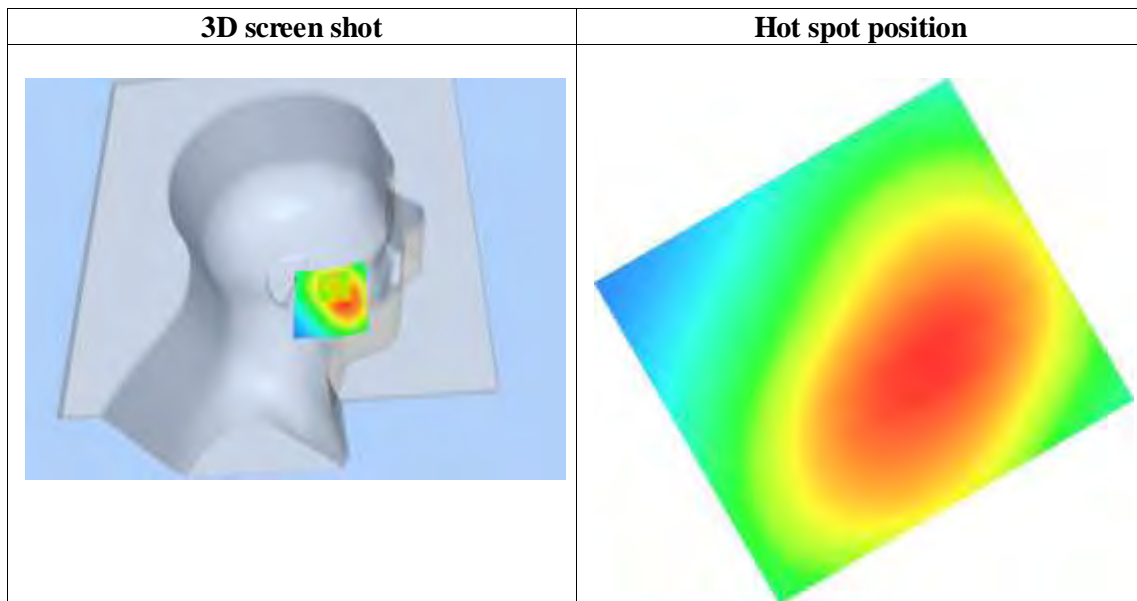
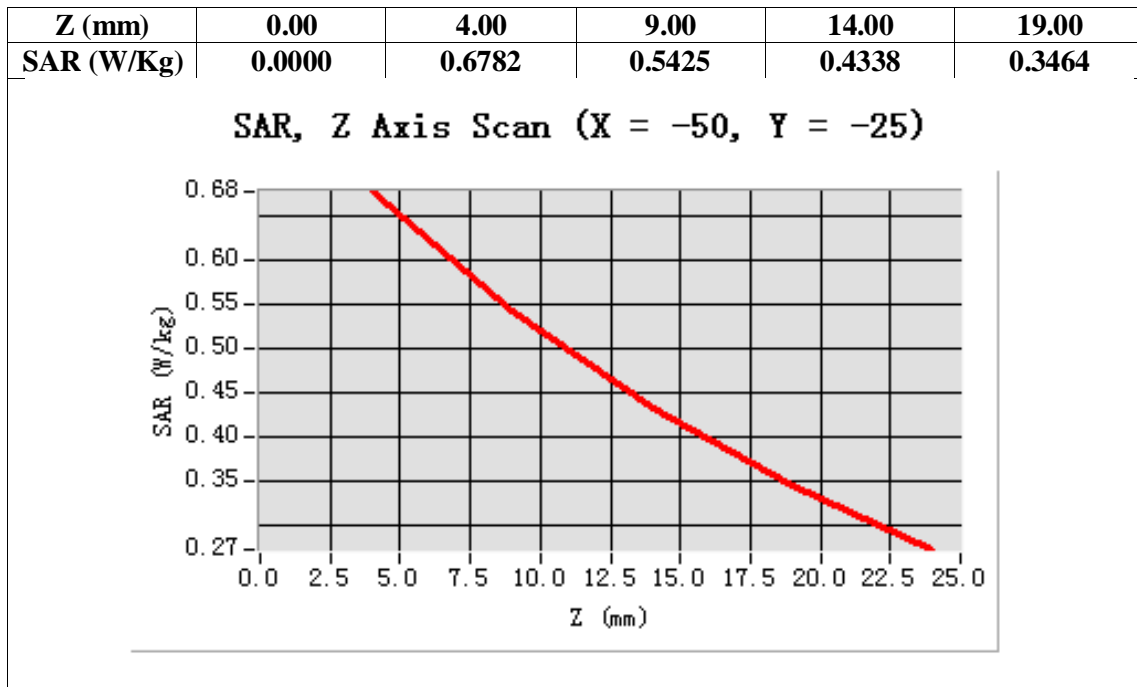

Test Laboratory: AGC Lab

Date: July 24,2014

WCDMA Band V Mid-Tilt-Right (RMC)

DUT: Mobile Phone; Type: QUE 5.0

Communication System: UMTS; Communication System Band: BAND V UTRA/FDD ; Duty Cycle:1: 1; Conv.F=5.27  
Frequency: 836.6 MHz; Medium parameters used:  $f = 835$  MHz;  $\sigma=0.88$  mho/m;  $\epsilon_r =41.91$ ;  $\rho= 1000$  kg/m<sup>3</sup> ;  
Phantom section: Right Section  
Ambient temperature (°C): 21, Liquid temperature (°C): 21

SATIMO Configuration:

- Probe: SSE5; Calibrated: 01/12/2014; Serial No.:SN 22/12 EP159
- Sensor-Surface: 4mm (Mechanical Surface Detection)
- Phantom: Flat Phantom; Type: Elliptical Phantom
- Measurement SW: OpenSAR V4\_02\_01

Configuration/ WCDMA Band V Mid-Tilt-Right/Area Scan: Measurement grid: dx=8mm, dy=8mm  
Configuration/ WCDMA Band V Mid-Tilt-Right/Zoom Scan: Measurement grid: dx=8mm, dy=8mm, dz=5mm;

Area Scan	sam_direct_droit2_surf8mm.txt
Zoom Scan	5x5x7,dx=8mm dy=8mm dz=5mm,Very fast
Phantom	Right head
Device Position	Tilt
Band	WCDMA Band V
Channels	Middle
Signal	TDMA (Crest factor: 1.0)

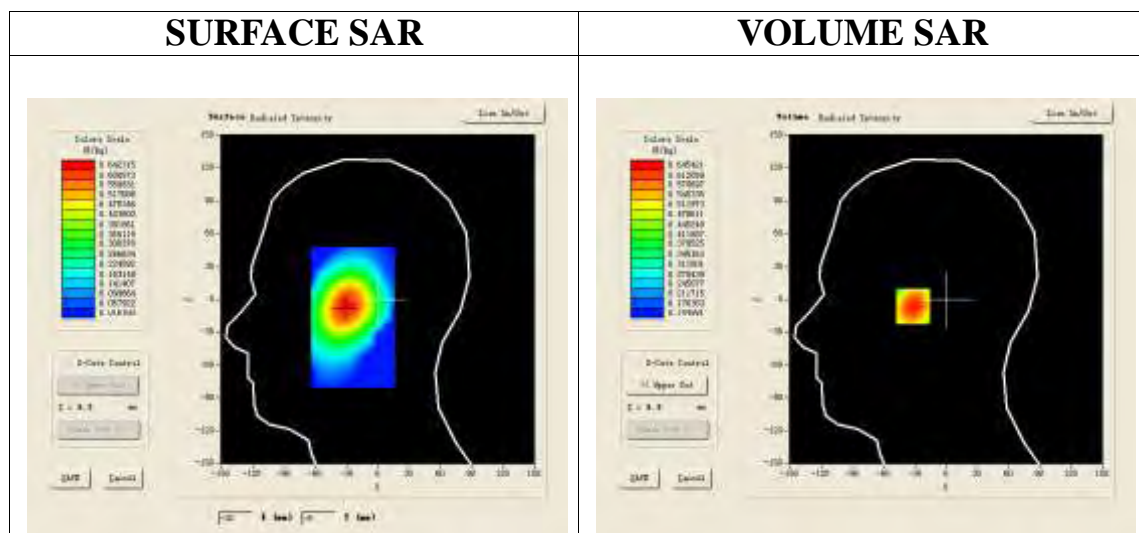

Maximum location: X=-30.00, Y=-6.00

SAR 10g (W/Kg)	0.452743
SAR 1g (W/Kg)	0.612647

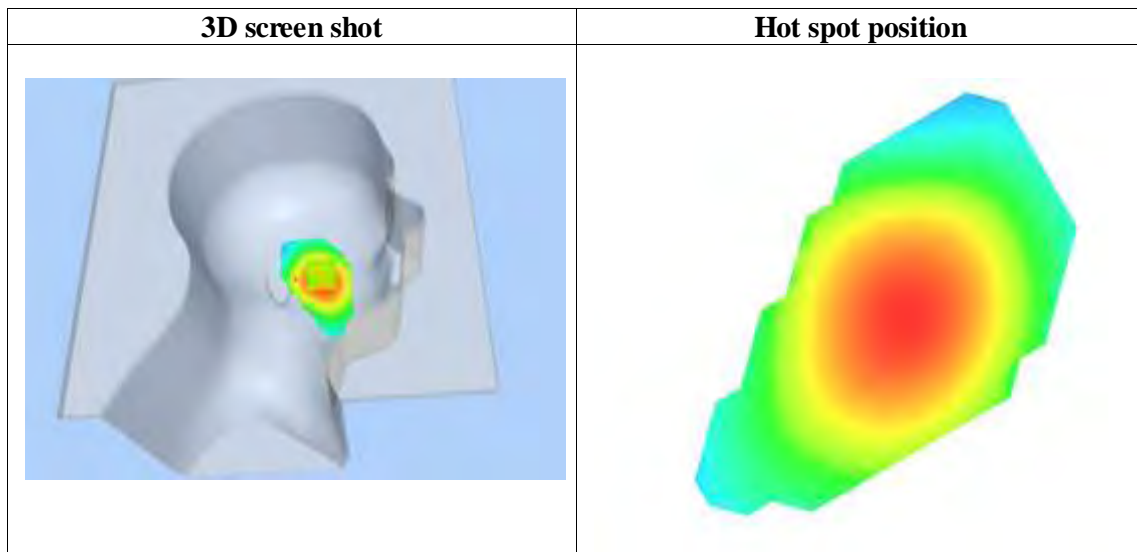
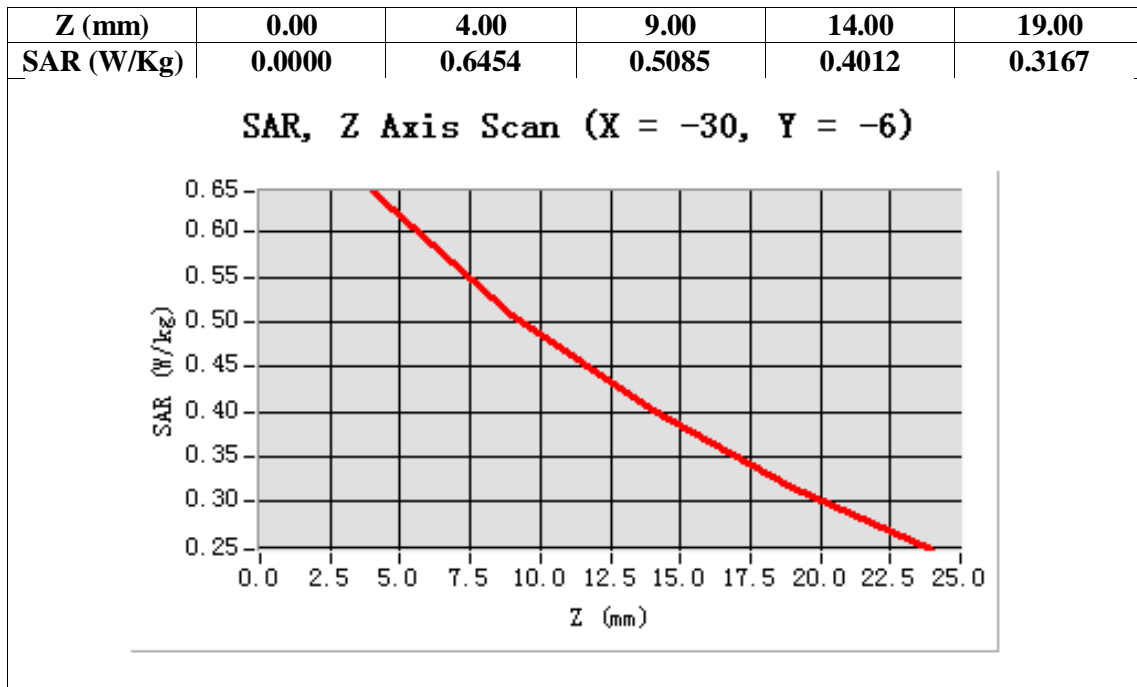

Test Laboratory: AGC Lab

Date: July 24,2014

WCDMA Band V Low-Body-Towards Grounds (RMC)

DUT: Mobile Phone; Type: QUE 5.0

Communication System: UMTS; Communication System Band: BAND V UTRA/FDD; Duty Cycle:1: 1; Conv.F=5.48  
Frequency: 826.4 MHz; Medium parameters used:  $f = 835\text{MHz}$ ;  $\sigma=0.96\text{ mho/m}$ ;  $\epsilon_r = 55.27$ ;  $\rho= 1000\text{ kg/m}^3$  ;  
Phantom section: Flat Section  
Ambient temperature ( $^{\circ}\text{C}$ ):21, Liquid temperature ( $^{\circ}\text{C}$ ):21

SATIMO Configuration:

- Probe: SSE5; Calibrated: 01/12/2014; Serial No.:SN 22/12 EP159
- Sensor-Surface: 4mm (Mechanical Surface Detection)
- Phantom: Flat Phantom; Type: Elliptical Phantom
- Measurement SW: OpenSAR V4\_02\_01

Configuration/ WCDMA Band V Low-Body-Back/Area Scan (6x8x1): Measurement grid:  $dx=8\text{mm}$ ,  $dy=8\text{mm}$   
Configuration/ WCDMA Band V Low-Body-Back/Zoom Scan (5x5x7)/Cube 0: Measurement grid:  
 $dx=8\text{mm}$ ,  $dy=8\text{mm}$ ,  $dz=5\text{mm}$ ;

Area Scan	surf_sam_plan.txt
ZoomScan	5x5x7,dx=8mm dy=8mm dz=5mm,Very fast
Phantom	Validation plane
Device Position	Body Back
Band	WCDMA Band V
Channels	Low
Signal	TDMA (Crest factor: 1.0)

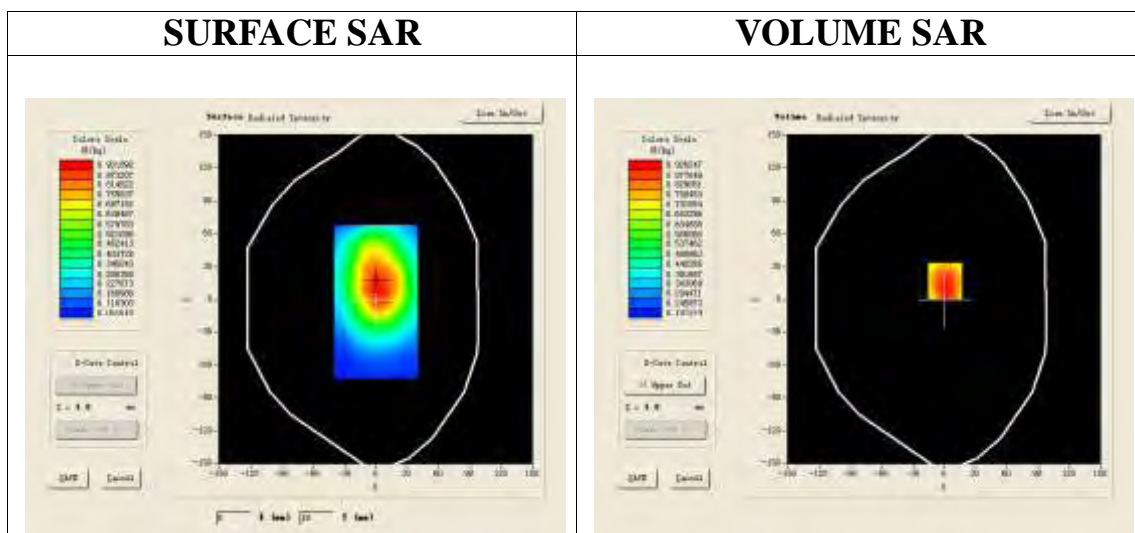

Maximum location: X=1.00, Y=17.00

SAR 10g (W/Kg)	0.683824
SAR 1g (W/Kg)	0.964181

Z (mm)	0.00	4.00	9.00	14.00	19.00
SAR (W/Kg)	0.0000	0.9168	0.6661	0.4927	0.3732

SAR, Z Axis Scan (X = 1, Y = 17)

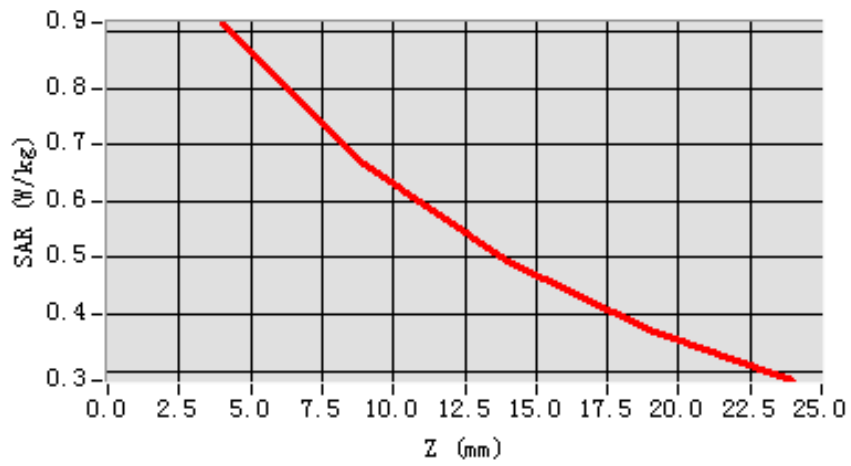

3D screen shot

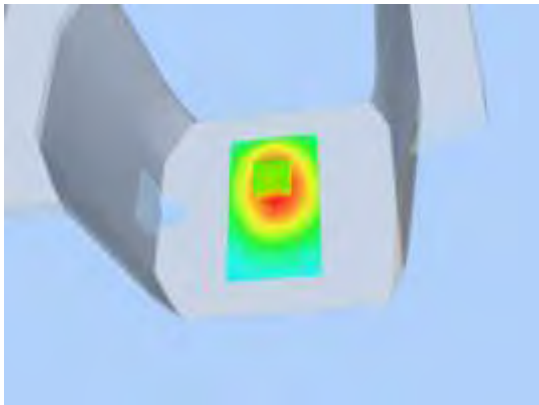

Hot spot position

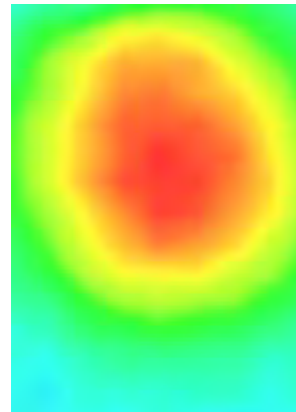

Test Laboratory: AGC Lab

Date: July 24,2014

WCDMA Band V Mid-Body-Towards Grounds (RMC)

DUT: Mobile Phone; Type: QUE 5.0

Communication System: UMTS; Communication System Band: BAND V UTRA/FDD; Duty Cycle:1: 1; Conv.F=5.48  
Frequency: 836.6 MHz; Medium parameters used:  $f = 835$  MHz;  $\sigma=0.96$  mho/m;  $\epsilon_r =55.76$ ;  $\rho= 1000$  kg/m<sup>3</sup> ;  
Phantom section: Flat Section  
Ambient temperature (°C):21, Liquid temperature (°C):21

SATIMO Configuration:

- Probe: SSE5; Calibrated: 01/12/2014; Serial No.:SN 22/12 EP159
- Sensor-Surface: 4mm (Mechanical Surface Detection)
- Phantom: Flat Phantom; Type: Elliptical Phantom
- Measurement SW: OpenSAR V4\_02\_01

Configuration/ WCDMA Band V Mid-Body-Back/Area Scan (6x8x1): Measurement grid: dx=8mm, dy=8mm  
Configuration/ WCDMA Band V Mid-Body-Back/Zoom Scan (5x5x7)/Cube 0: Measurement grid:  
dx=8mm,dy=8mm, dz=5mm;

Area Scan	surf_sam_plan.txt
ZoomScan	5x5x7,dx=8mm dy=8mm dz=5mm,Very fast
Phantom	Validation plane
Device Position	Body Back
Band	WCDMA Band V
Channels	Middle
Signal	TDMA (Crest factor: 1.0)

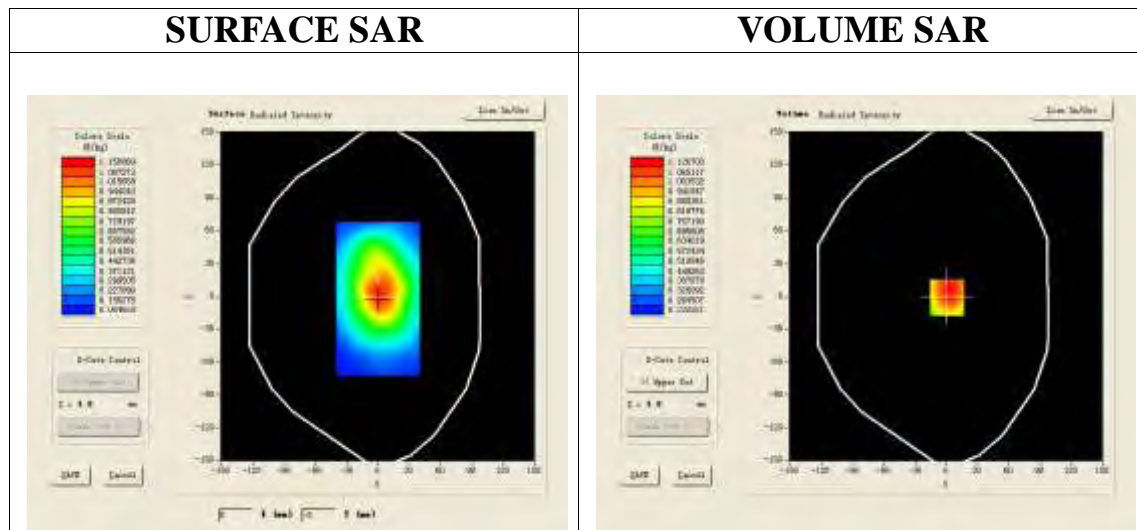

Maximum location: X=1.00, Y=-1.00

SAR 10g (W/Kg)	0.825239
SAR 1g (W/Kg)	1.178404

Z (mm)	0.00	4.00	9.00	14.00	19.00
SAR (W/Kg)	0.0000	1.1180	0.7970	0.5812	0.4373

SAR, Z Axis Scan (X = 1, Y = -1)

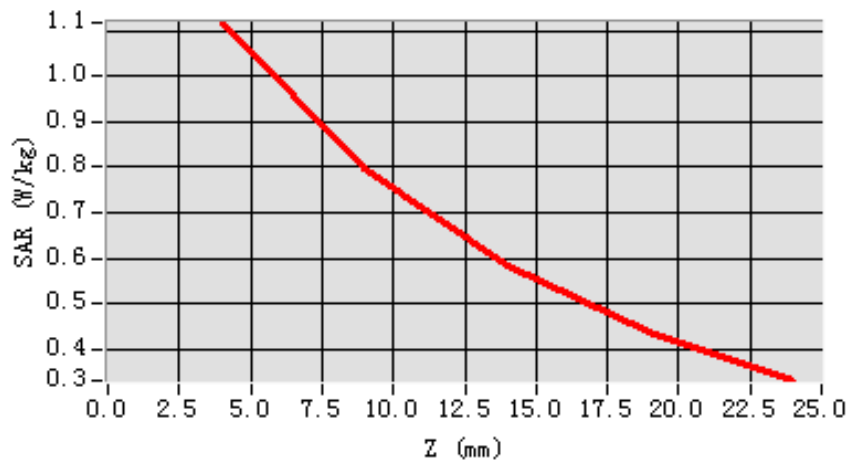

3D screen shot

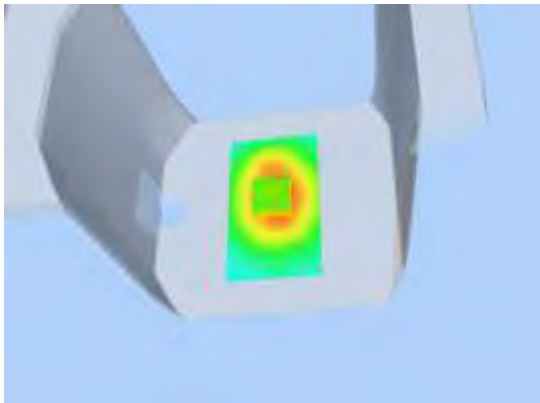

Hot spot position

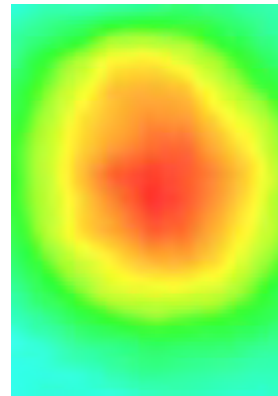



Test Laboratory: AGC Lab

Date: July 24,2014

WCDMA Band V High-Body-Towards Grounds (RMC)

DUT: Mobile Phone; Type: QUE 5.0

Communication System: UMTS; Communication System Band: BAND V UTRA/FDD; Duty Cycle:1: 1; Conv.F=5.48  
Frequency: 846.6 MHz; Medium parameters used:  $f = 835\text{MHz}$ ;  $\sigma=0.94\text{mho/m}$ ;  $\epsilon_r=55.41$ ;  $\rho= 1000 \text{ kg/m}^3$  ;  
Phantom section: Flat Section  
Ambient temperature ( $^{\circ}\text{C}$ ):21, Liquid temperature ( $^{\circ}\text{C}$ ):21

SATIMO Configuration:

- Probe: SSE5; Calibrated: 01/12/2014; Serial No.:SN 22/12 EP159
- Sensor-Surface: 4mm (Mechanical Surface Detection)
- Phantom: Flat Phantom; Type: Elliptical Phantom
- Measurement SW: OpenSAR V4\_02\_01

Configuration/ WCDMA Band V High-Body-Back/Area Scan (6x8x1): Measurement grid:  $dx=8\text{mm}$ ,  $dy=8\text{mm}$   
Configuration/ WCDMA Band V High-Body-Back/Zoom Scan (5x5x7)/Cube 0: Measurement grid:  
 $dx=8\text{mm}$ ,  $dy=8\text{mm}$ ,  $dz=5\text{mm}$ ;

Area Scan	surf_sam_plan.txt
ZoomScan	5x5x7,dx=8mm dy=8mm dz=5mm,Very fast
Phantom	Validation plane
Device Position	Body Back
Band	WCDMA Band V
Channels	High
Signal	TDMA (Crest factor: 1.0)

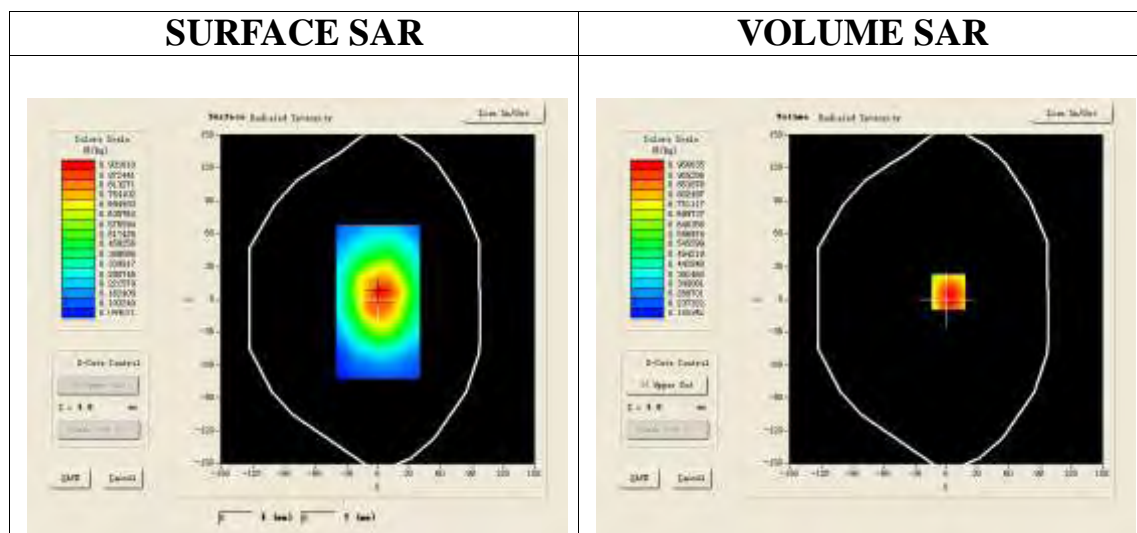

Maximum location: X=2.00, Y=7.00

SAR 10g (W/Kg)	0.705818
SAR 1g (W/Kg)	1.000054

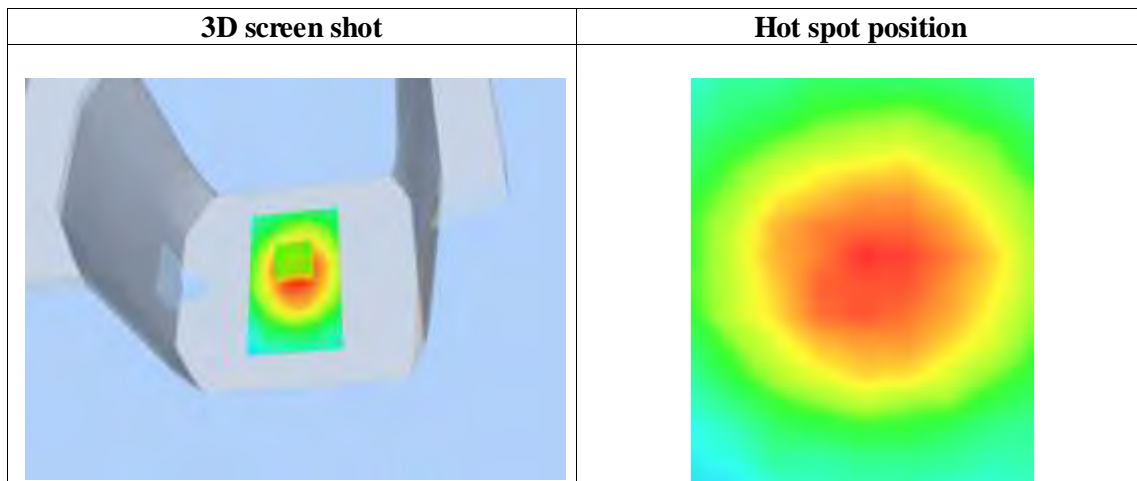
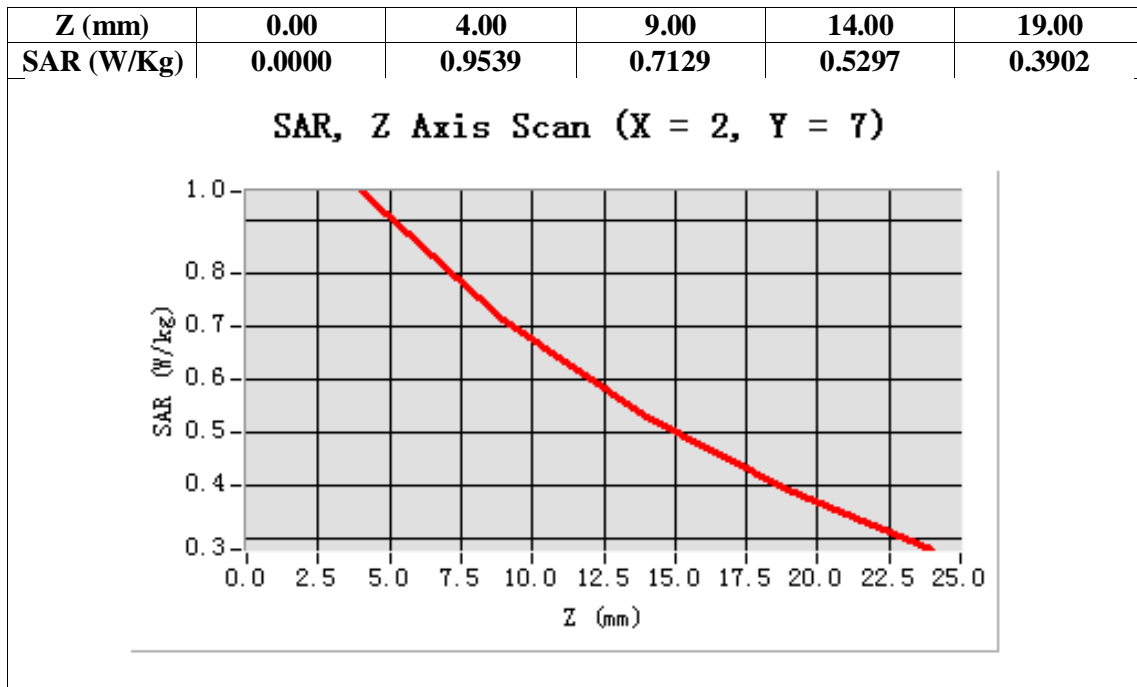

Test Laboratory: AGC Lab

Date: July 24,2014

WCDMA Band V Mid- Body - Towards Phantom (RMC)

DUT: Mobile Phone; Type: QUE 5.0

Communication System: UMTS; Communication System Band: BAND V UTRA/FDD ; Duty Cycle:1: 1; Conv.F=5.48  
Frequency: 836.6 MHz; Medium parameters used:  $f = 835$  MHz; $\sigma=0.96$  mho/m;  $\epsilon_r =55.76$ ;  $\rho= 1000$ kg/m<sup>3</sup> ;  
Phantom section: Flat Section  
Ambient temperature (°C):21, Liquid temperature (°C):21

SATIMO Configuration:

- Probe: SSE5; Calibrated: 01/12/2014; Serial No.:SN 22/12 EP159
- Sensor-Surface: 4mm (Mechanical Surface Detection)
- Phantom: Flat Phantom; Type: Elliptical Phantom
- Measurement SW: OpenSAR V4\_02\_01

Configuration/ WCDMA Band V Mid-Body-Front/Area Scan (6x8x1): Measurement grid: dx=8mm, dy=8mm  
Configuration/ WCDMA Band V Mid-Body-Front/Zoom Scan (5x5x7)/Cube 0: Measurement grid: dx=8mm, dy=8mm, dz=5mm;

Area Scan	surf_sam_plan.txt
ZoomScan	5x5x7,dx=8mm dy=8mm dz=5mm,Very fast
Phantom	Validation plane
Device Position	Body Front
Band	WCDMA Band V
Channels	Middle
Signal	TDMA (Crest factor: 1.0)

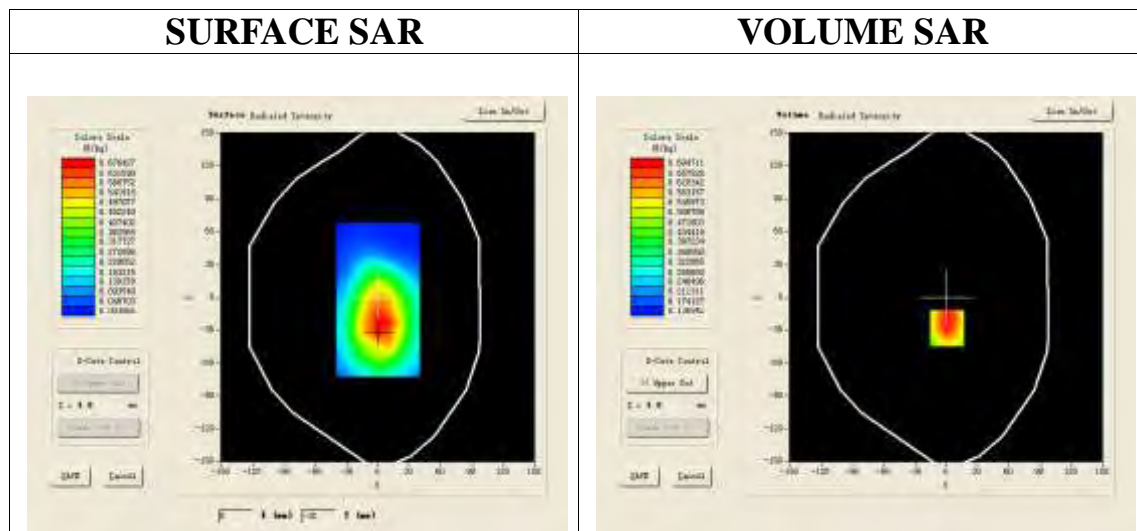

Maximum location: X=1.00, Y=-28.00

SAR 10g (W/Kg)	0.464637
SAR 1g (W/Kg)	0.667263

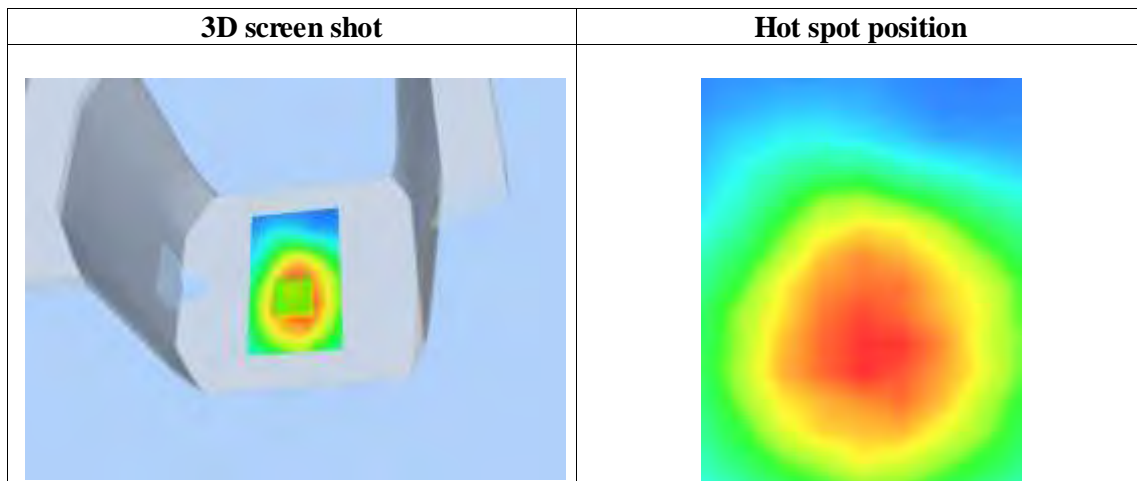
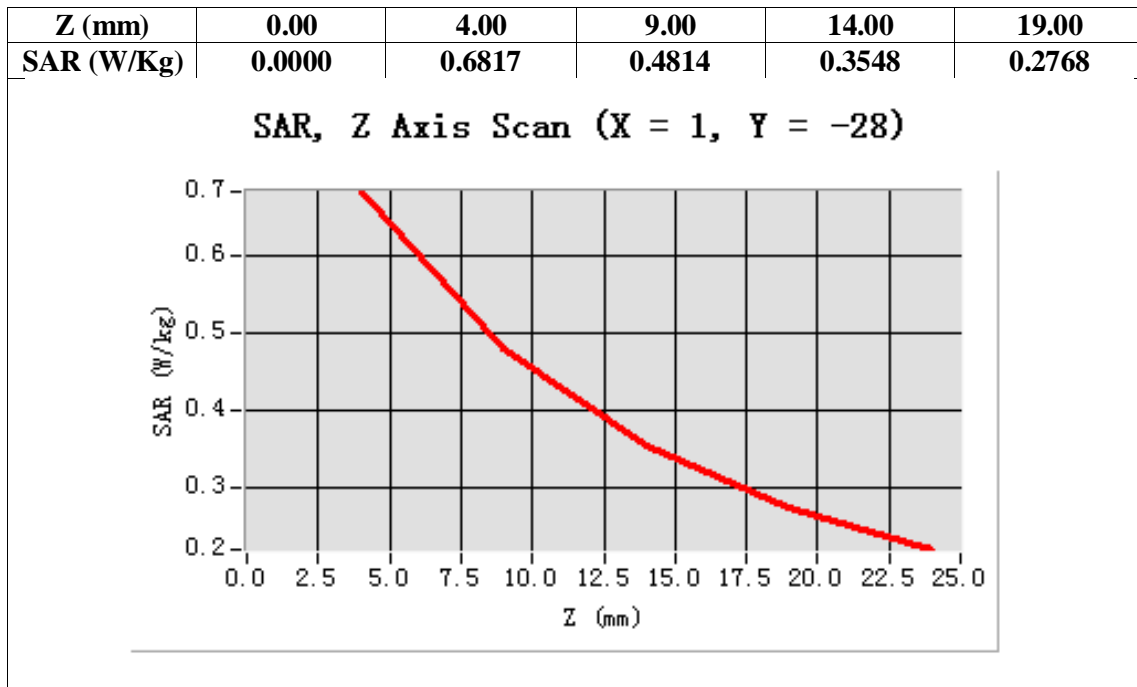

**Test Laboratory: AGC Lab**  
**WCDMA Band IV Mid-Touch-Left (RMC )**  
**DUT: Mobile Phone; Type: QUE 5.0**

**Date: July 24,2014**

Communication System: UMTS; Communication System Band: BAND IV UTRA/FDD ; Duty Cycle:1: 1; Conv F=4.58  
Frequency: 1732.6 MHz; Medium parameters used:  $f = 1700\text{MHz}$ ;  $\sigma=1.38 \text{ mho/m}$ ;  $\epsilon_r=40.16$ ;  $\rho= 1000 \text{ kg/m}^3$  ;  
Phantom section: Left Section  
Ambient temperature ( $^{\circ}\text{C}$ ): 21, Liquid temperature ( $^{\circ}\text{C}$ ): 21

SATIMO Configuration:

- Probe: SSE5; Calibrated: 01/12/2014; Serial No.:SN 22/12 EP159
- Sensor-Surface: 4mm (Mechanical Surface Detection)
- Phantom: Flat Phantom; Type: Elliptical Phantom
- Measurement SW: OpenSAR V4\_02\_01

**Configuration/ WCDMA Band IV Mid-Touch-Left/Area Scan (6x8x1): Measurement grid: dx=8mm, dy=8mm**  
**Configuration/ WCDMA Band IV Mid-Touch-Left/Zoom Scan (5x5x7)/Cube 0: Measurement grid: dx=8mm, dy=8mm, dz=5mm**

<b>Area Scan</b>	sam_direct_droit2_surf8mm.txt
<b>ZoomScan</b>	5x5x7,dx=8mm dy=8mm dz=5mm,Very fast
<b>Phantom</b>	Left head
<b>Device Position</b>	Cheek
<b>Band</b>	WCDMA Band IV
<b>Channels</b>	Middle
<b>Signal</b>	TDMA (Crest factor: 1.0)

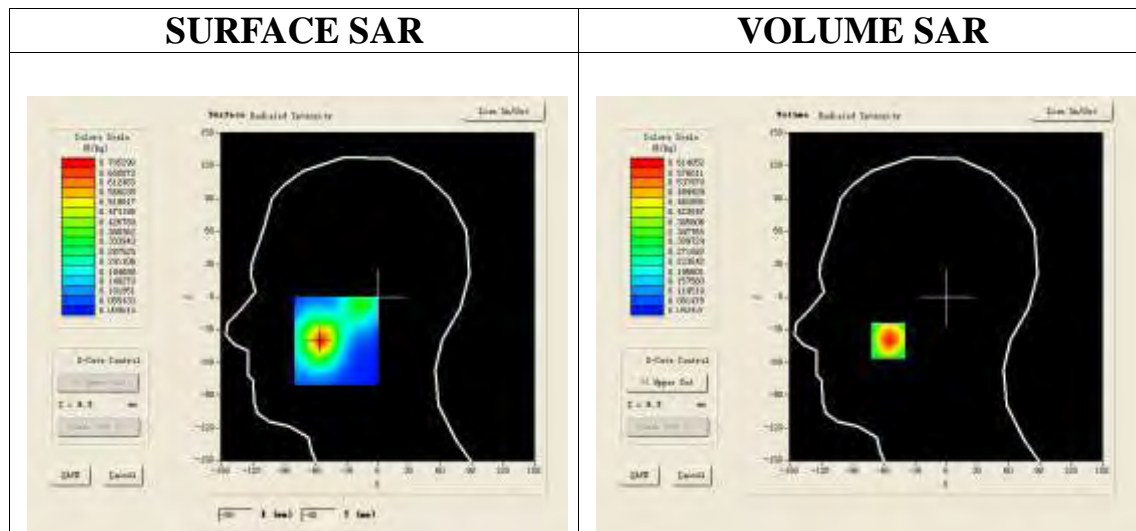

**Maximum location: X=-56.00, Y=-40.00**

<b>SAR 10g (W/Kg)</b>	0.354768
<b>SAR 1g (W/Kg)</b>	0.573763

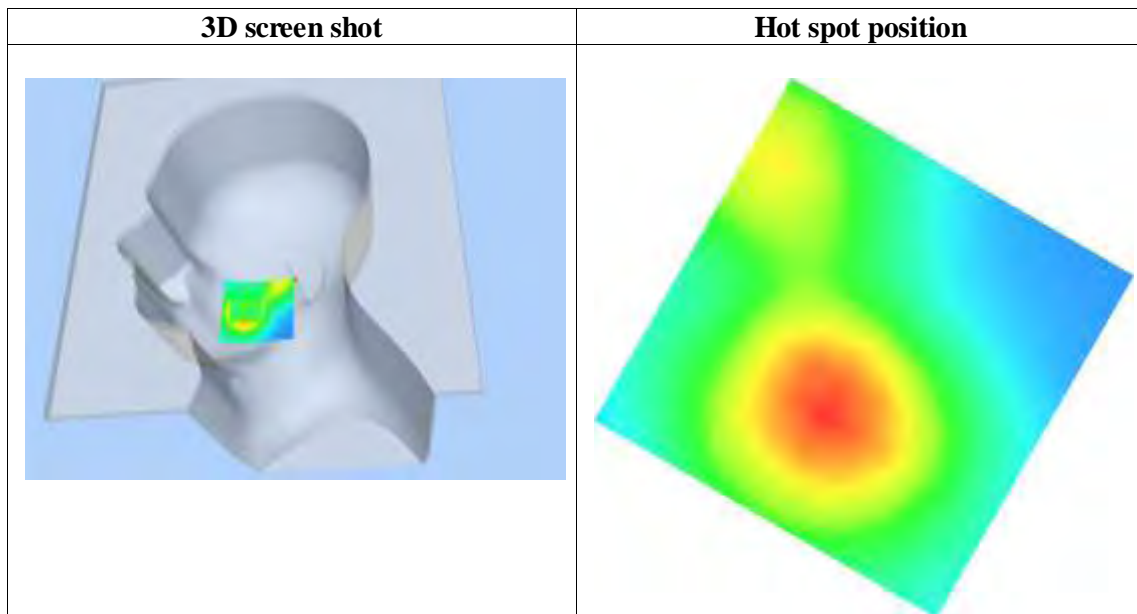
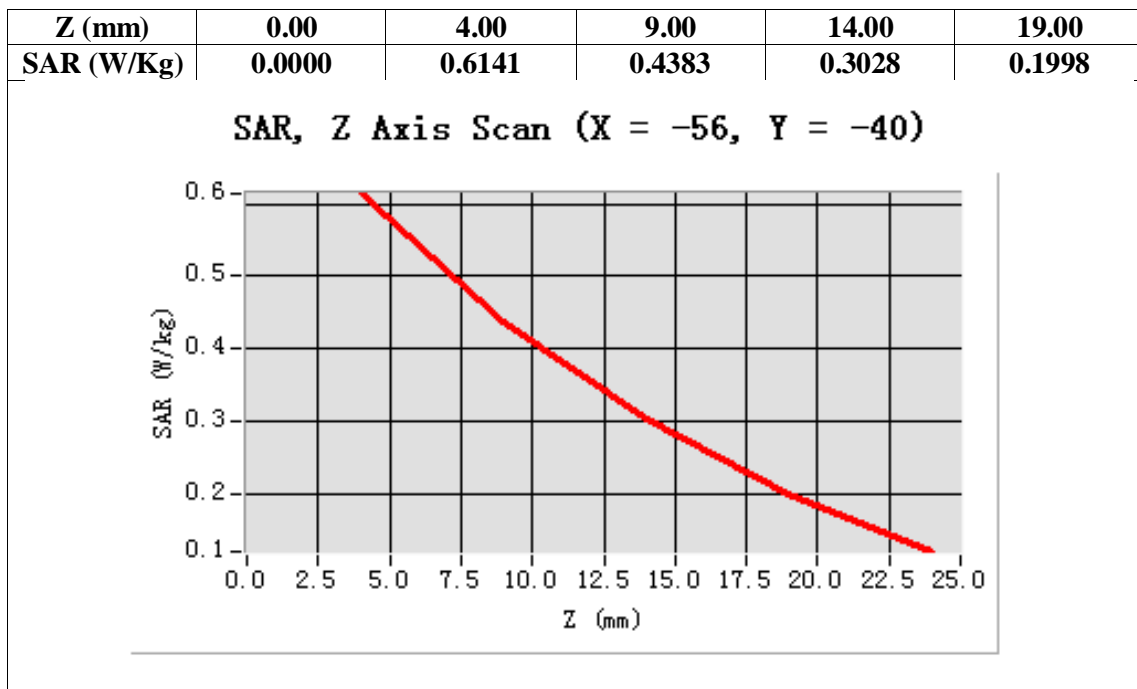

Test Laboratory: AGC Lab  
WCDMA Band IV Mid-Tilt-Left (RMC)  
DUT: Mobile Phone; Type: QUE 5.0

Date: July 24,2014

Communication System: UMTS; Communication System Band: BAND IV UTRA/FDD ; Duty Cycle:1: 1; Conv.F=4.58  
Frequency: 1732.6 MHz; Medium parameters used:  $f = 1700\text{MHz}$ ;  $\sigma=1.38\text{ mho/m}$ ;  $\epsilon_r=40.16$ ;  $\rho= 1000\text{ kg/m}^3$  ;  
Phantom section: Left Section  
Ambient temperature ( $^{\circ}\text{C}$ ): 21, Liquid temperature ( $^{\circ}\text{C}$ ): 21

SATIMO Configuration:

- Probe: SSE5; Calibrated: 01/12/2014; Serial No.:SN 22/12 EP159
- Sensor-Surface: 4mm (Mechanical Surface Detection)
- Phantom: Flat Phantom; Type: Elliptical Phantom
- Measurement SW: OpenSAR V4\_02\_01

Configuration/ WCDMA Band IV Mid-Tilt-Left/Area Scan (6x8x1): Measurement grid:  $dx=8\text{mm}$ ,  $dy=8\text{mm}$   
Configuration/ WCDMA Band IV Mid-Tilt-Left/Zoom Scan (5x5x7)/Cube 0: Measurement grid:  $dx=8\text{mm}$ ,  $dy=8\text{mm}$ ,  $dz=5\text{mm}$ ;

Area Scan	sam_direct_droit2_surf8mm.txt
ZoomScan	5x5x7,dx=8mm dy=8mm dz=5mm,Very fast
Phantom	Left head
Device Position	Tilt
Band	WCDMA Band IV
Channels	Middle
Signal	TDMA (Crest factor: 1.0)

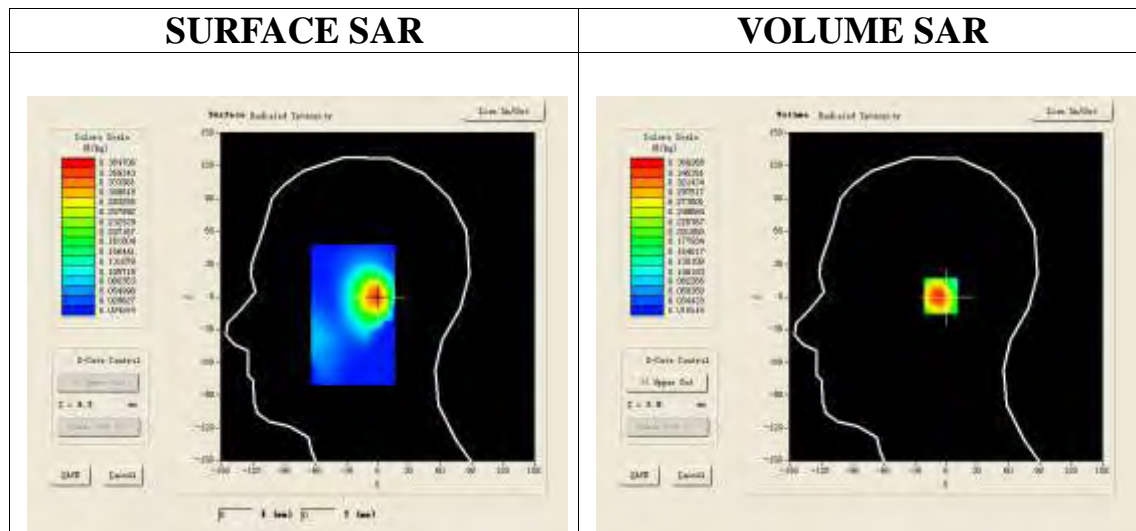

Maximum location: X=-1.00, Y=1.00

SAR 10g (W/Kg)	0.203642
SAR 1g (W/Kg)	0.347245

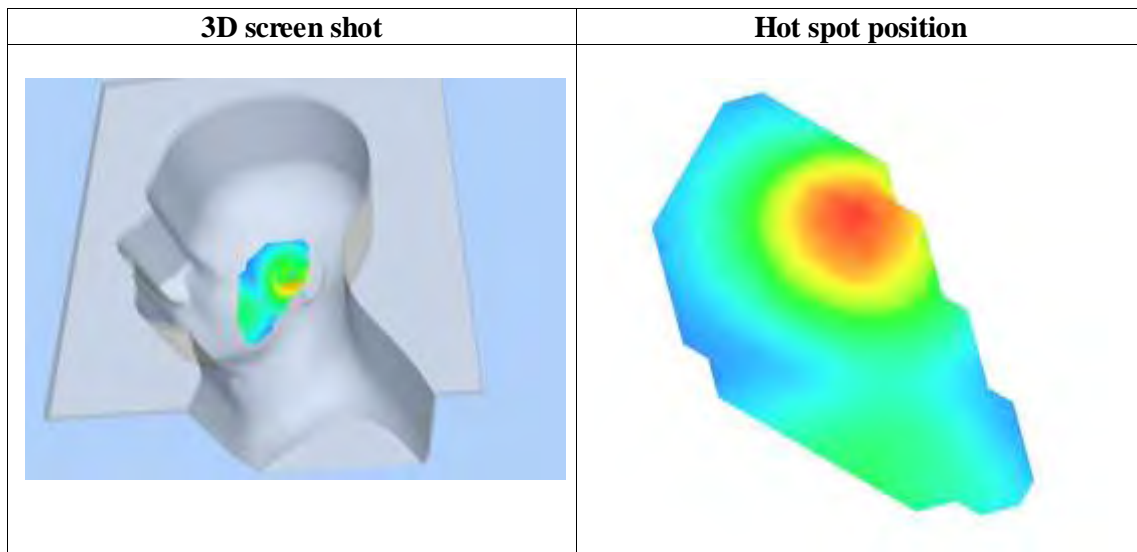
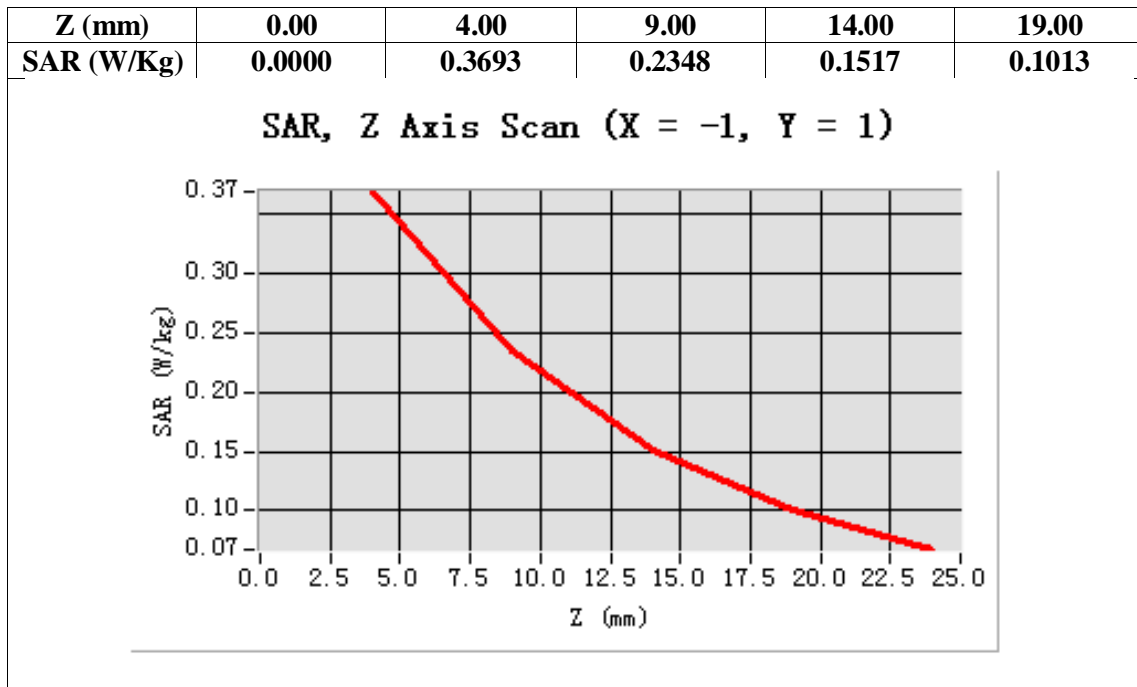



Test Laboratory: AGC Lab  
WCDMA Band IV Mid- Touch-Right (RMC)  
DUT: Mobile Phone; Type: QUE 5.0

Date: July 24,2014

Communication System: UMTS; Communication System Band: BAND IV UTRA/FDD ; Duty Cycle:1: 1; Conv.F=4.58  
Frequency: 1732.6 MHz; Medium parameters used:  $f = 1700\text{MHz}$ ;  $\sigma=1.38 \text{ mho/m}$ ;  $\epsilon_r=40.16$ ;  $\rho= 1000 \text{ kg/m}^3$  ;  
Phantom section: Right Section  
Ambient temperature ( $^{\circ}\text{C}$ ): 21, Liquid temperature ( $^{\circ}\text{C}$ ): 21

SATIMO Configuration:

- Probe: SSE5; Calibrated: 01/12/2014; Serial No.:SN 22/12 EP159
- Sensor-Surface: 4mm (Mechanical Surface Detection)
- Phantom: Flat Phantom; Type: Elliptical Phantom
- Measurement SW: OpenSAR V4\_02\_01

Configuration/ WCDMA Band IV Mid-Touch-Right/Area Scan: Measurement grid:  $dx=8\text{mm}$ ,  $dy=8\text{mm}$   
Configuration/ WCDMA Band IV Mid-Touch-Right/Zoom Scan: Measurement grid:  $dx=8\text{mm}$ ,  
 $dy=8\text{mm}$ ,  $dz=5\text{mm}$ ;

Area Scan	sam_direct_droit2_surf8mm.txt
ZoomScan	5x5x7,dx=8mm dy=8mm dz=5mm,Very fast
Phantom	Right head
Device Position	Cheek
Band	WCDMA Band IV
Channels	Middle
Signal	TDMA (Crest factor: 1.0)

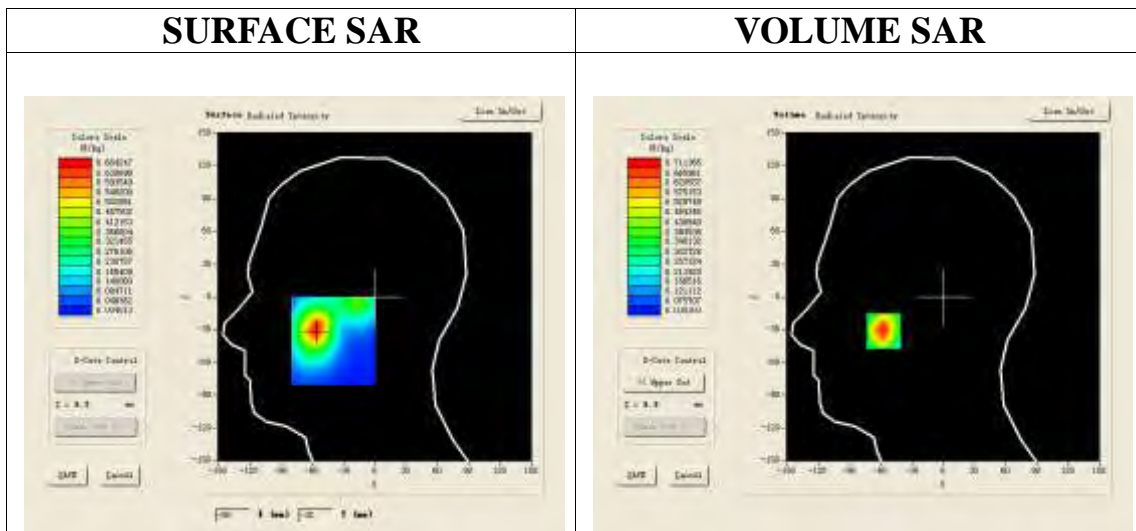

Maximum location: X=-57.00, Y=-31.00

SAR 10g (W/Kg)	0.381795
SAR 1g (W/Kg)	0.666532

Z (mm)	0.00	4.00	9.00	14.00	19.00
SAR (W/Kg)	0.0000	0.7114	0.4782	0.3117	0.1947

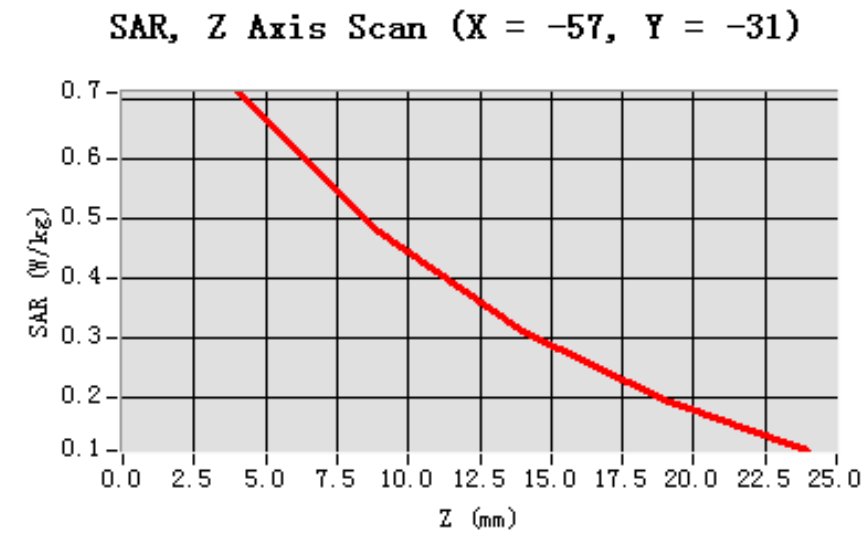

3D screen shot	Hot spot position
<p>A 3D rendering of a human head model, shown in profile. A small, rectangular area on the ear is highlighted with a color gradient from blue (low SAR) to red (high SAR), indicating the location of the maximum SAR exposure.</p>	<p>A 2D heatmap representing the SAR distribution on the ear area. The color scale ranges from blue (low SAR) to red (high SAR). A prominent red circular region is centered on the ear, indicating the location of the maximum SAR exposure.</p>

Test Laboratory: AGC Lab  
WCDMA Band IV Mid-Tilt-Right (RMC)  
DUT: Mobile Phone; Type: QUE 5.0

Date: July 24,2014

Communication System: UMTS; Communication System Band: BAND IV UTRA/FDD ; Duty Cycle:1: 1; Conv.F=4.58  
Frequency: 1732.6 MHz; Medium parameters used:  $f = 1700\text{MHz}$ ;  $\sigma=1.38\text{ mho/m}$ ;  $\epsilon_r=40.16$ ;  $\rho= 1000\text{ kg/m}^3$  ;  
Phantom section: Right Section  
Ambient temperature ( $^{\circ}\text{C}$ ): 21, Liquid temperature ( $^{\circ}\text{C}$ ): 21

SATIMO Configuration:

- Probe: SSE5; Calibrated: 01/12/2014; Serial No.:SN 22/12 EP159
- Sensor-Surface: 4mm (Mechanical Surface Detection)
- Phantom: Flat Phantom; Type: Elliptical Phantom
- Measurement SW: OpenSAR V4\_02\_01

Configuration/ WCDMA Band IV Mid-Tilt-Right/Area Scan: Measurement grid:  $dx=8\text{mm}$ ,  $dy=8\text{mm}$   
Configuration/ WCDMA Band IV Mid-Tilt-Right/Zoom Scan: Measurement grid:  $dx=8\text{mm}$ ,  
 $dy=8\text{mm}$ ,  $dz=5\text{mm}$ ;

Area Scan	sam_direct_droit2_surf8mm.txt
Zoom Scan	5x5x7,dx=8mm dy=8mm dz=5mm,Very fast
Phantom	Right head
Device Position	Tilt
Band	WCDMA Band IV
Channels	Middle
Signal	TDMA (Crest factor: 1.0)

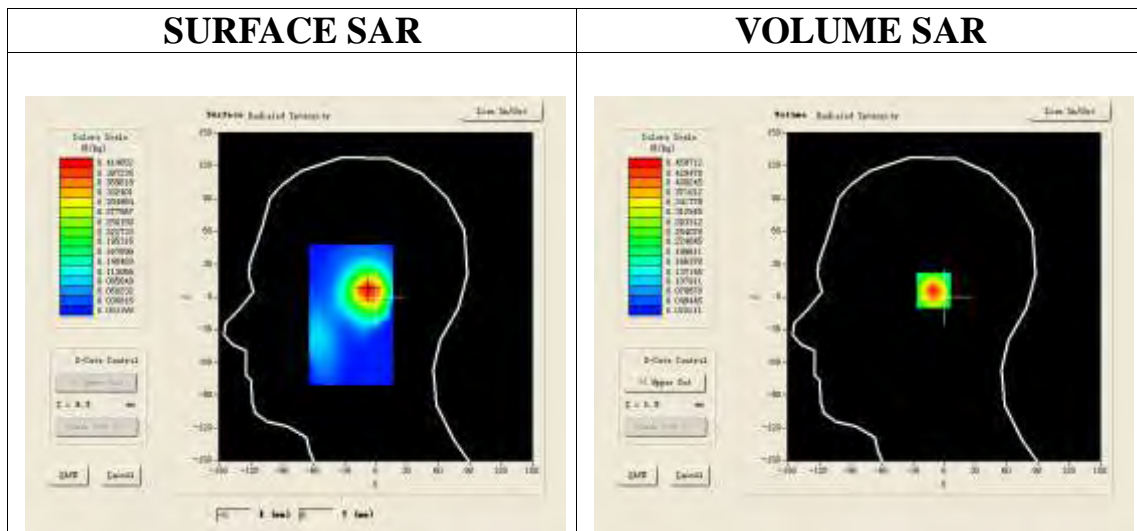

Maximum location: X=-7.00, Y=6.00

SAR 10g (W/Kg)	0.247834
SAR 1g (W/Kg)	0.426934

Z (mm)	0.00	4.00	9.00	14.00	19.00
SAR (W/Kg)	0.0000	0.4587	0.3002	0.1961	0.1286

SAR, Z Axis Scan (X = -7, Y = 6)

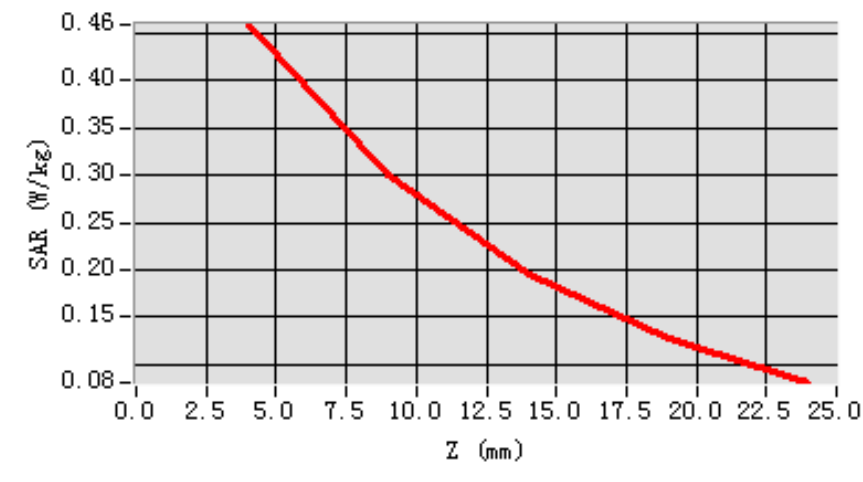

3D screen shot

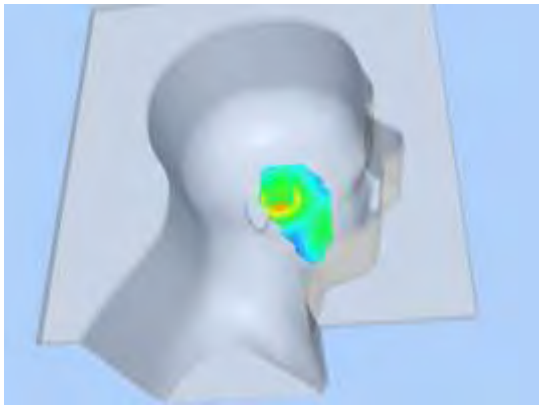

Hot spot position

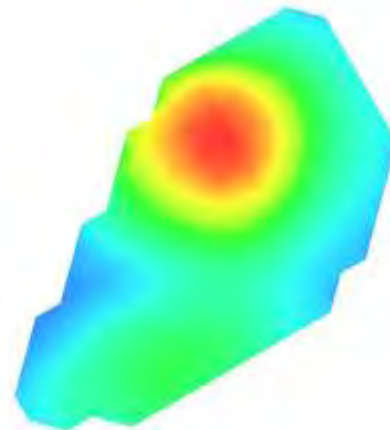

Test Laboratory: AGC Lab  
WCDMA Band IV Low-Body-Towards Grounds (RMC)  
DUT: Mobile Phone; Type: QUE 5.0

Date: July 24,2014

Communication System: UMTS; Communication System Band: BAND IV UTRA/FDD; Duty Cycle:1: 1; Conv.F=4.71  
Frequency: 1712.4 MHz; Medium parameters used:  $f = 1700\text{MHz}$ ;  $\sigma = 1.49 \text{ mho/m}$ ;  $\epsilon_r = 53.18$ ;  $\rho = 1000 \text{ kg/m}^3$  ;  
Phantom section: Flat Section  
Ambient temperature ( $^{\circ}\text{C}$ ):21, Liquid temperature ( $^{\circ}\text{C}$ ):21

SATIMO Configuration:

- Probe: SSE5; Calibrated: 01/12/2014; Serial No.:SN 22/12 EP159
- Sensor-Surface: 4mm (Mechanical Surface Detection)
- Phantom: Flat Phantom; Type: Elliptical Phantom
- Measurement SW: OpenSAR V4\_02\_01

Configuration/ WCDMA Band IV Low-Body-Back/Area Scan (6x8x1): Measurement grid:  $dx=8\text{mm}$ ,  $dy=8\text{mm}$   
Configuration/ WCDMA Band IV Low-Body-Back/Zoom Scan (5x5x7)/Cube 0: Measurement grid:  $dx=8\text{mm}$ , $dy=8\text{mm}$ ,  $dz=5\text{mm}$ ;

Area Scan	surf_sam_plan.txt
ZoomScan	5x5x7,dx=8mm dy=8mm dz=5mm,Very fast
Phantom	Validation plane
Device Position	Body Back
Band	WCDMA Band IV
Channels	Low
Signal	TDMA (Crest factor: 1.0)

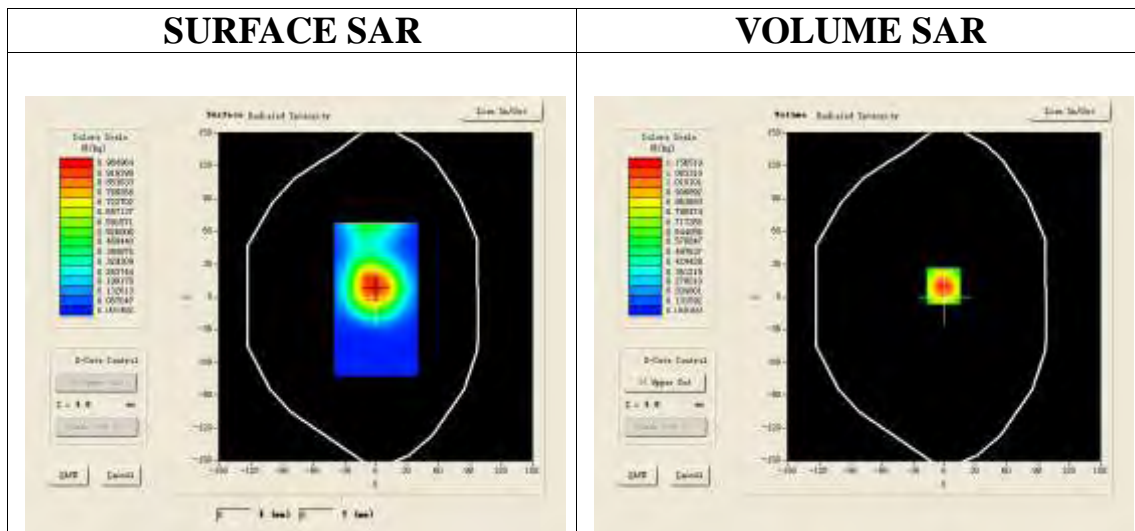

Maximum location: X=-1.00, Y=10.00

SAR 10g (W/Kg)	0.663683
SAR 1g (W/Kg)	1.174754

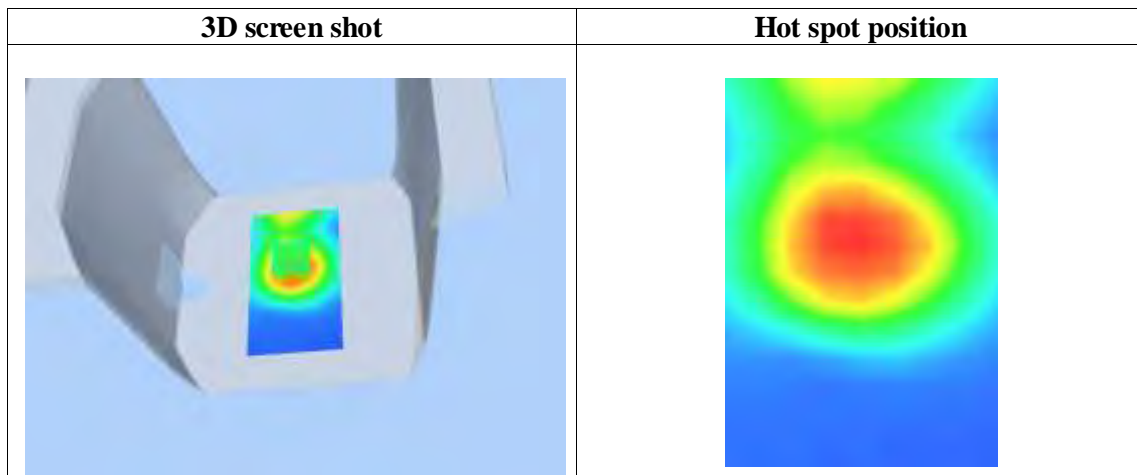
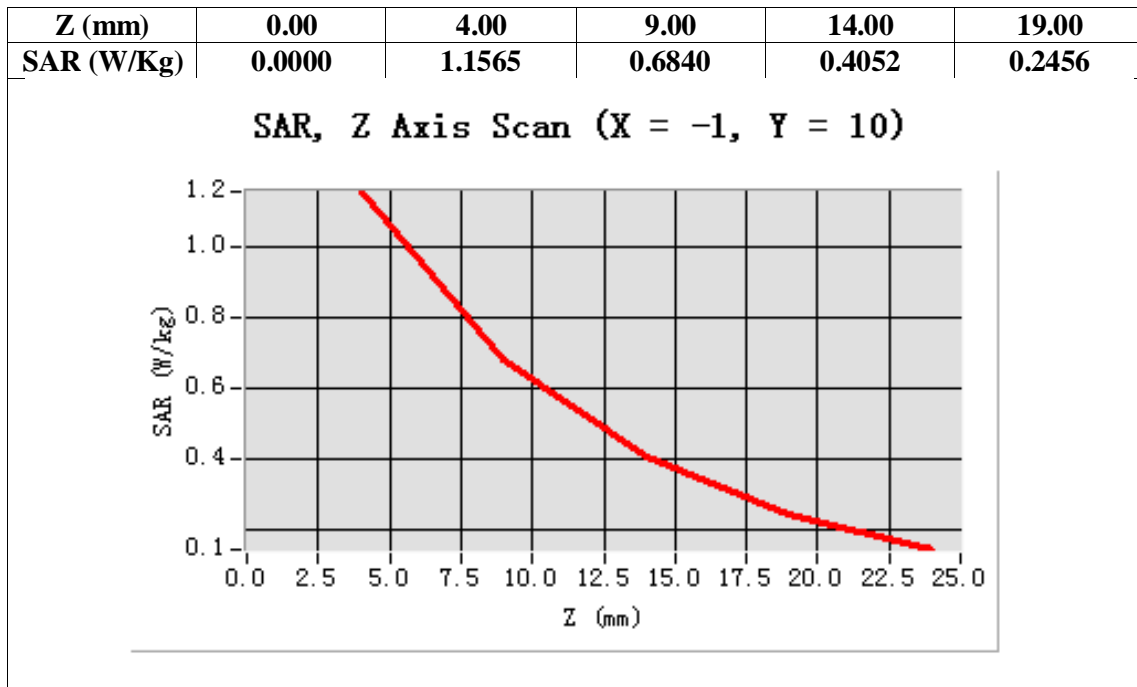

Test Laboratory: AGC Lab  
WCDMA Band IV Mid-Body-Towards Grounds (RMC)  
DUT: Mobile Phone; Type: QUE 5.0

Date: July 24,2014

Communication System: UMTS; Communication System Band: BAND IV UTRA/FDD; Duty Cycle:1: 1; Conv.F=4.71  
Frequency: 1732.6 MHz; Medium parameters used:  $f = 1700\text{MHz}$ ;  $\sigma = 1.50\text{ mho/m}$ ;  $\epsilon_r = 53.17$ ;  $\rho = 1000\text{ kg/m}^3$  ;  
Phantom section: Flat Section  
Ambient temperature ( $^{\circ}\text{C}$ ):21, Liquid temperature ( $^{\circ}\text{C}$ ):21

SATIMO Configuration:

- Probe: SSE5; Calibrated: 01/12/2014; Serial No.:SN 22/12 EP159
- Sensor-Surface: 4mm (Mechanical Surface Detection)
- Phantom: Flat Phantom; Type: Elliptical Phantom
- Measurement SW: OpenSAR V4\_02\_01

Configuration/ WCDMA Band IV Mid-Body-Back/Area Scan (6x8x1): Measurement grid:  $dx=8\text{mm}$ ,  $dy=8\text{mm}$   
Configuration/ WCDMA Band IV Mid-Body-Back/Zoom Scan (5x5x7)/Cube 0: Measurement grid:  $dx=8\text{mm}$ , $dy=8\text{mm}$ ,  $dz=5\text{mm}$ ;

Area Scan	surf_sam_plan.txt
ZoomScan	5x5x7,dx=8mm dy=8mm dz=5mm,Very fast
Phantom	Validation plane
Device Position	Body Back
Band	WCDMA Band IV
Channels	Middle
Signal	TDMA (Crest factor: 1.0)

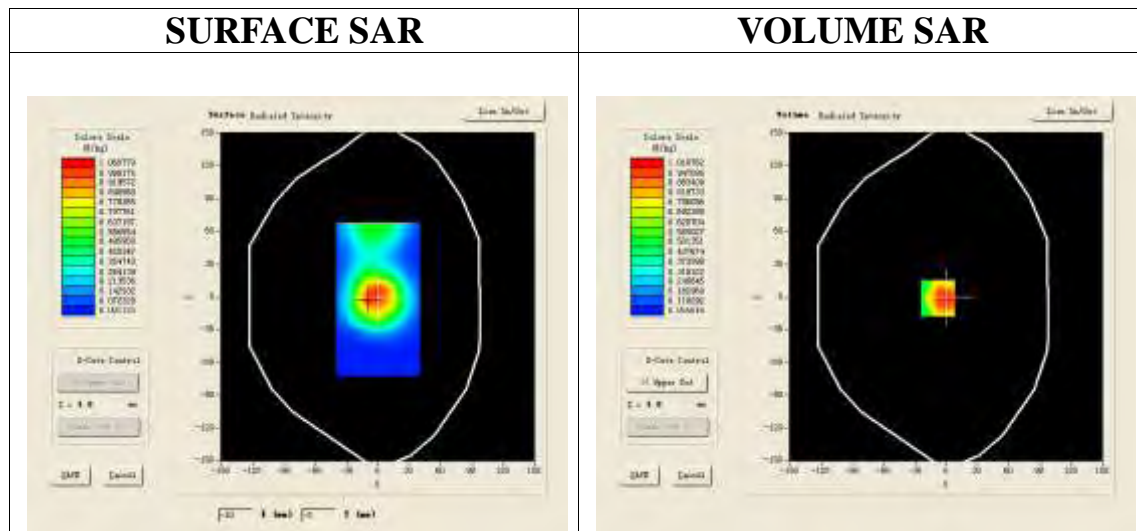

Maximum location: X=-8.00, Y=-1.00

SAR 10g (W/Kg)	0.647638
SAR 1g (W/Kg)	1.031894

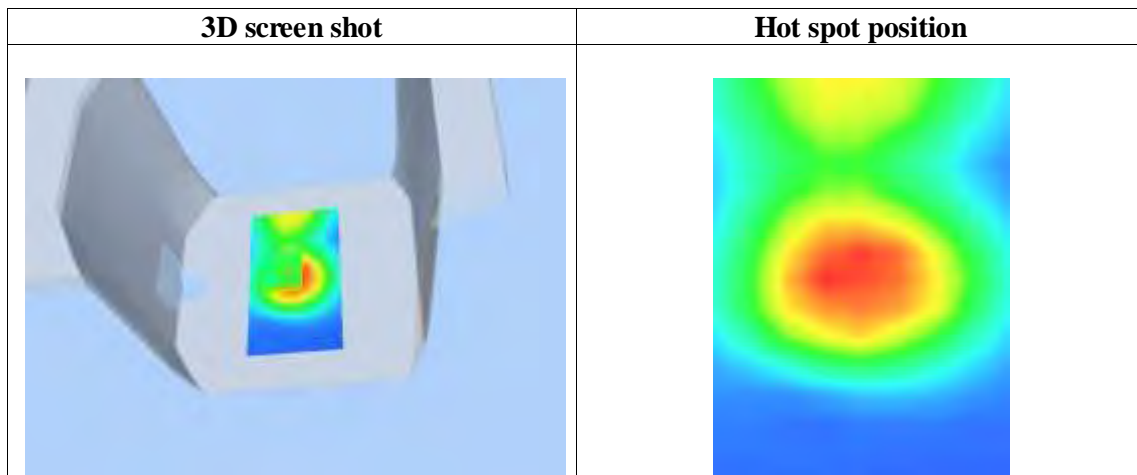
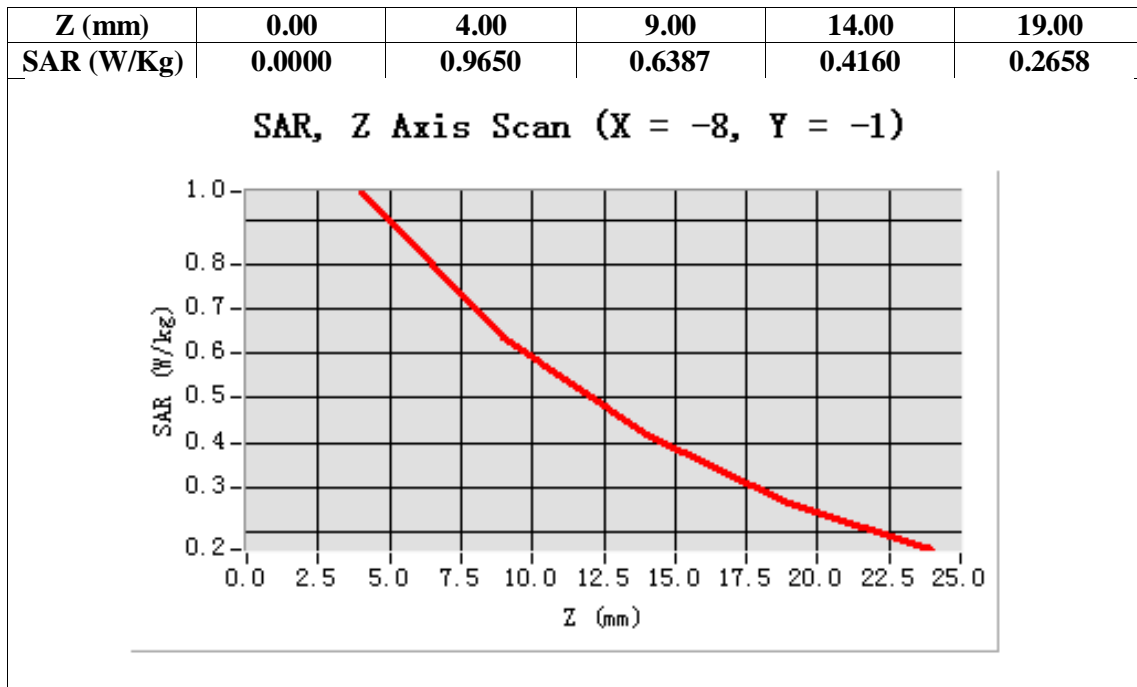



Test Laboratory: AGC Lab  
WCDMA Band IV High-Body-Towards Grounds (RMC)  
DUT: Mobile Phone; Type: QUE 5.0

Date: July 24,2014

Communication System: UMTS; Communication System Band: BAND IV UTRA/FDD; Duty Cycle:1: 1; Conv.F=4.71  
Frequency: 1752.6 MHz; Medium parameters used:  $f = 1700\text{MHz}$ ;  $\sigma = 1.53 \text{ mho/m}$ ;  $\epsilon_r = 53.55$ ;  $\rho = 1000 \text{ kg/m}^3$  ;  
Phantom section: Flat Section  
Ambient temperature ( $^{\circ}\text{C}$ ):21, Liquid temperature ( $^{\circ}\text{C}$ ):21

SATIMO Configuration:

- Probe: SSE5; Calibrated: 01/12/2014; Serial No.:SN 22/12 EP159
- Sensor-Surface: 4mm (Mechanical Surface Detection)
- Phantom: Flat Phantom; Type: Elliptical Phantom
- Measurement SW: OpenSAR V4\_02\_01

Configuration/ WCDMA Band IV High-Body-Back/Area Scan (6x8x1): Measurement grid:  $dx=8\text{mm}$ ,  $dy=8\text{mm}$   
Configuration/ WCDMA Band IV High-Body-Back/Zoom Scan (5x5x7)/Cube 0: Measurement grid:  
 $dx=8\text{mm}$ , $dy=8\text{mm}$ ,  $dz=5\text{mm}$ ;

Area Scan	surf_sam_plan.txt
ZoomScan	5x5x7,dx=8mm dy=8mm dz=5mm,Very fast
Phantom	Validation plane
Device Position	Body Back
Band	WCDMA Band IV
Channels	High
Signal	TDMA (Crest factor: 1.0)

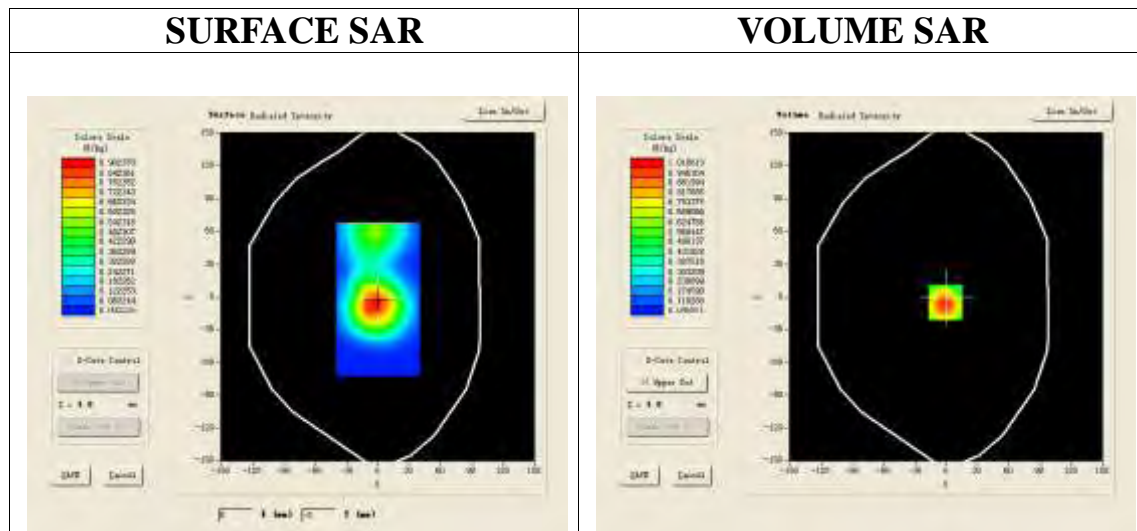

Maximum location: X=-1.00, Y=-5.00

SAR 10g (W/Kg)	0.578722
SAR 1g (W/Kg)	1.034551

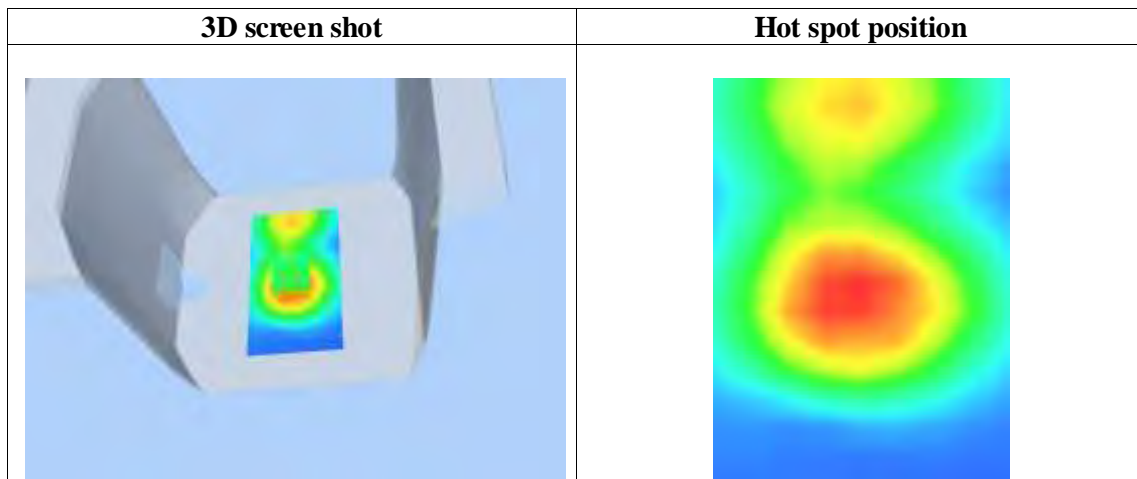
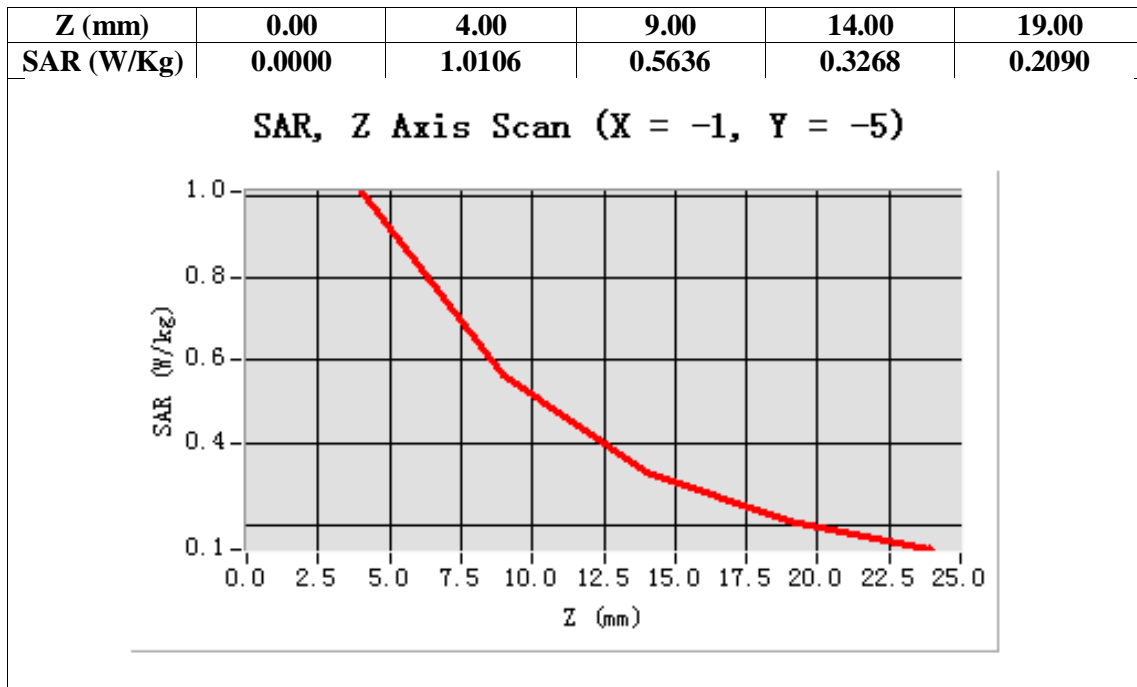

**Test Laboratory: AGC Lab**  
**WCDMA Band IV Mid- Body - Towards Phantom (RMC)**  
**DUT: Mobile Phone; Type: QUE 5.0**

**Date: July 24,2014**

Communication System: UMTS; Communication System Band: BAND IV UTRA/FDD ; Duty Cycle:1: 1; Conv.F=4.71  
Frequency: 1732.6 MHz; Medium parameters used:  $f = 1700\text{MHz}$ ;  $\sigma=1.50\text{ mho/m}$ ;  $\epsilon_r=53.17$ ;  $\rho= 1000\text{ kg/m}^3$  ;  
Phantom section: Flat Section  
Ambient temperature ( $^{\circ}\text{C}$ ):21, Liquid temperature ( $^{\circ}\text{C}$ ):21

SATIMO Configuration:

- Probe: SSE5; Calibrated: 01/12/2014; Serial No.:SN 22/12 EP159
- Sensor-Surface: 4mm (Mechanical Surface Detection)
- Phantom: Flat Phantom; Type: Elliptical Phantom
- Measurement SW: OpenSAR V4\_02\_01

**Configuration/ WCDMA Band IV Mid-Body-Front/Area Scan (6x8x1): Measurement grid: dx=8mm, dy=8mm**  
**Configuration/ WCDMA Band IV Mid-Body-Front/Zoom Scan (5x5x7)/Cube 0: Measurement grid: dx=8mm, dy=8mm, dz=5mm;**

<b>Area Scan</b>	surf_sam_plan.txt
<b>ZoomScan</b>	5x5x7,dx=8mm dy=8mm dz=5mm,Very fast
<b>Phantom</b>	Validation plane
<b>Device Position</b>	Body Front
<b>Band</b>	WCDMA Band IV
<b>Channels</b>	Middle
<b>Signal</b>	TDMA (Crest factor: 1.0)

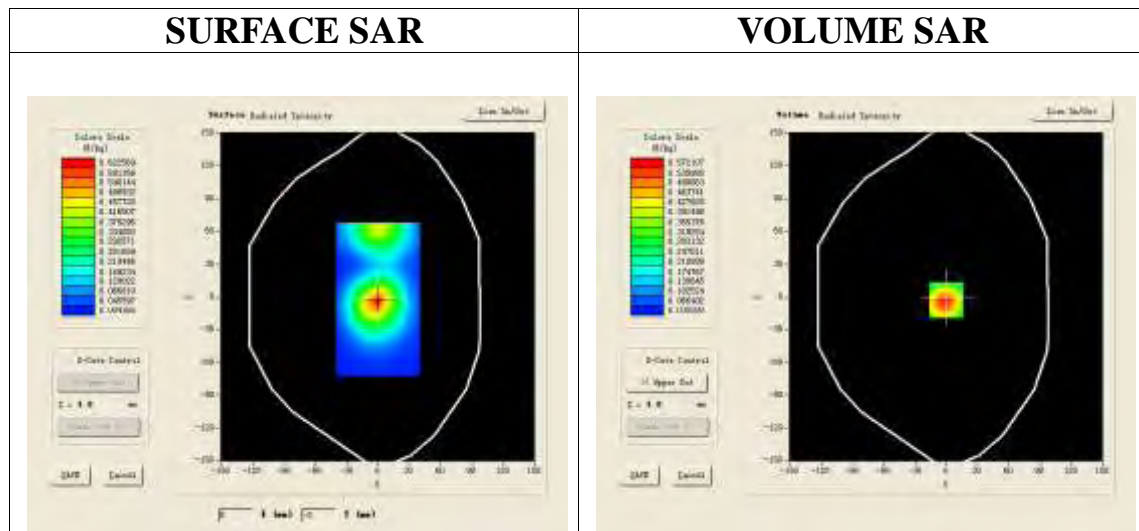

**Maximum location: X=0.00, Y=-3.00**

<b>SAR 10g (W/Kg)</b>	0.342659
<b>SAR 1g (W/Kg)</b>	0.583826

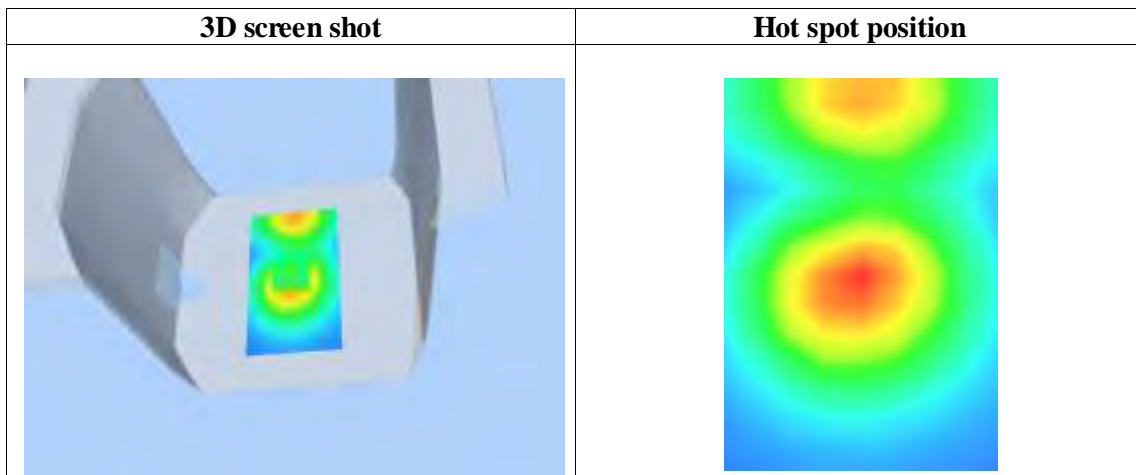
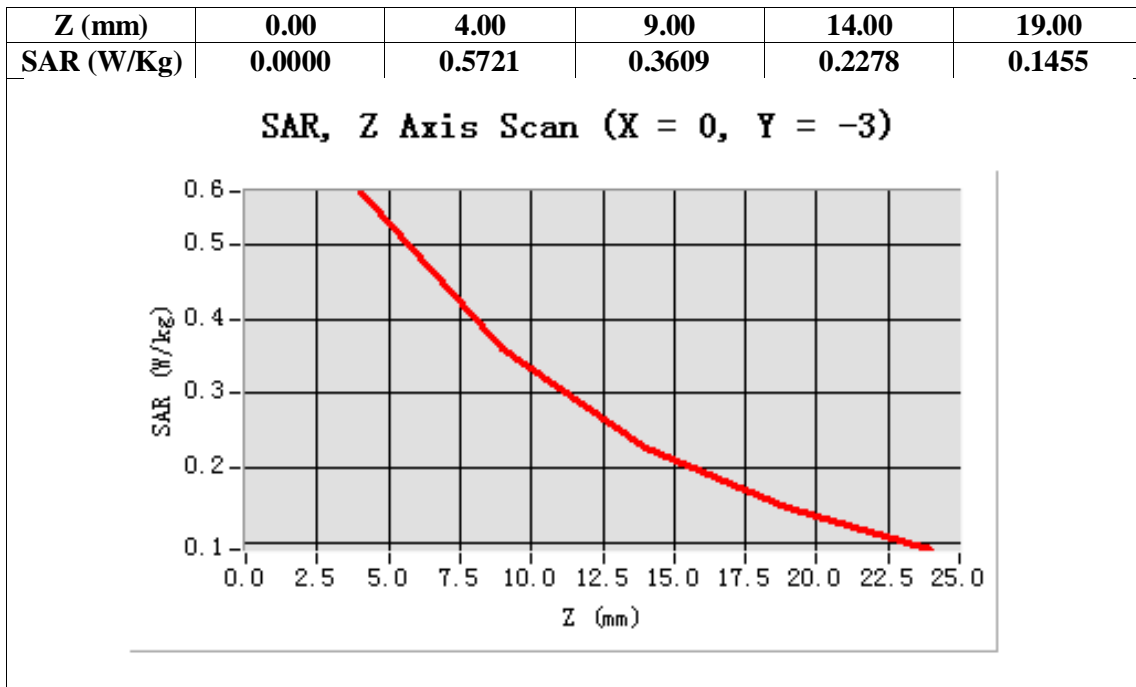

**HOTSPOT MODE**

Test Laboratory: AGC Lab

Date: July 24,2014

Hotspot Mid-Body-Worn- Back (DTS)

DUT: Mobile Phone; Type: QUE 5.0

Communication System: Wi-Fi; Communication System Band: Hotspot; Duty Cycle: 1:1; Conv.F=4.31;  
Frequency: 2437 MHz; Medium parameters used:  $f = 2450$  MHz;  $\sigma = 1.87$  mho/m;  $\epsilon_r = 52.55$ ;  $\rho = 1000$  kg/m<sup>3</sup> ;  
Phantom section: Flat Section  
Ambient temperature (°C):21, Liquid temperature (°C):21

SATIMO Configuration:

- Probe: SSE5; Calibrated: 01/12/2014; Serial No.:SN 22/12 EP159
- Sensor-Surface: 4mm (Mechanical Surface Detection)
- Phantom: Flat Phantom; Type: Elliptical Phantom
- Measurement SW: OpenSAR V4\_02\_01

**Configuration/Hotspot Mid- Body- Back /Area Scan (6x8x1):** Measurement grid: dx=8mm, dy=8mm  
**Configuration/Hotspot Mid- Body- Back /Zoom Scan (5x5x7)/Cube 0:** Measurement grid: dx=8mm, dy=8mm, dz=5mm;

<b>Area Scan</b>	surf_sam_plan.txt
<b>ZoomScan</b>	5x5x7,dx=8mm dy=8mm dz=5mm,Very fast
<b>Phantom</b>	Validation plane
<b>Device Position</b>	Body Back
<b>Band</b>	2450MHz
<b>Channels</b>	Middle
<b>Signal</b>	TDMA (Crest factor: 8.0)

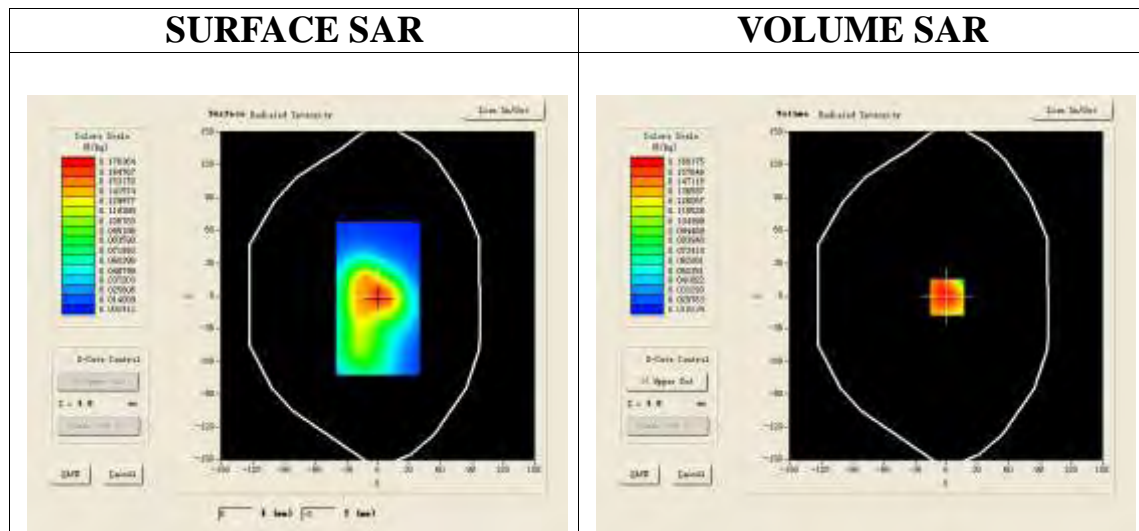

**Maximum location: X=1.00, Y=-1.00**

<b>SAR 10g (W/Kg)</b>	0.101038
<b>SAR 1g (W/Kg)</b>	0.174615

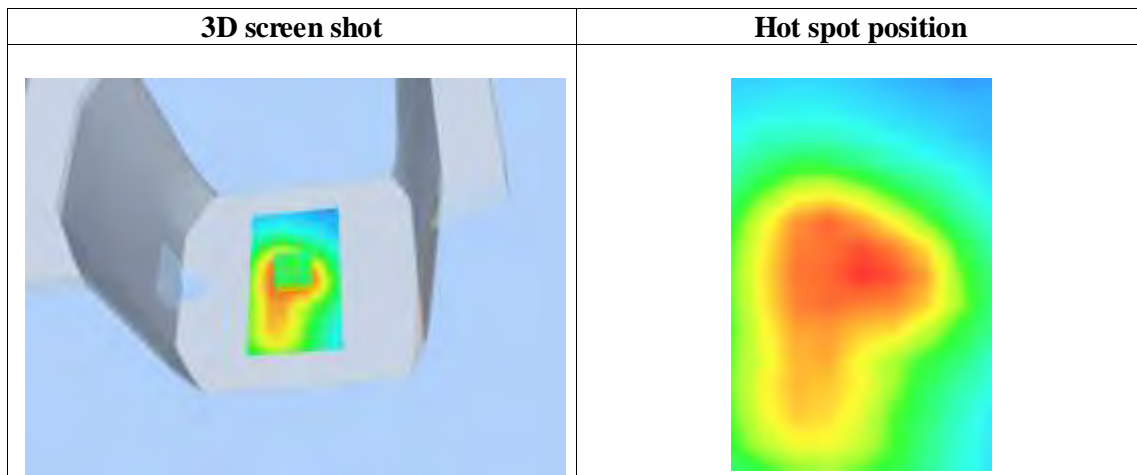
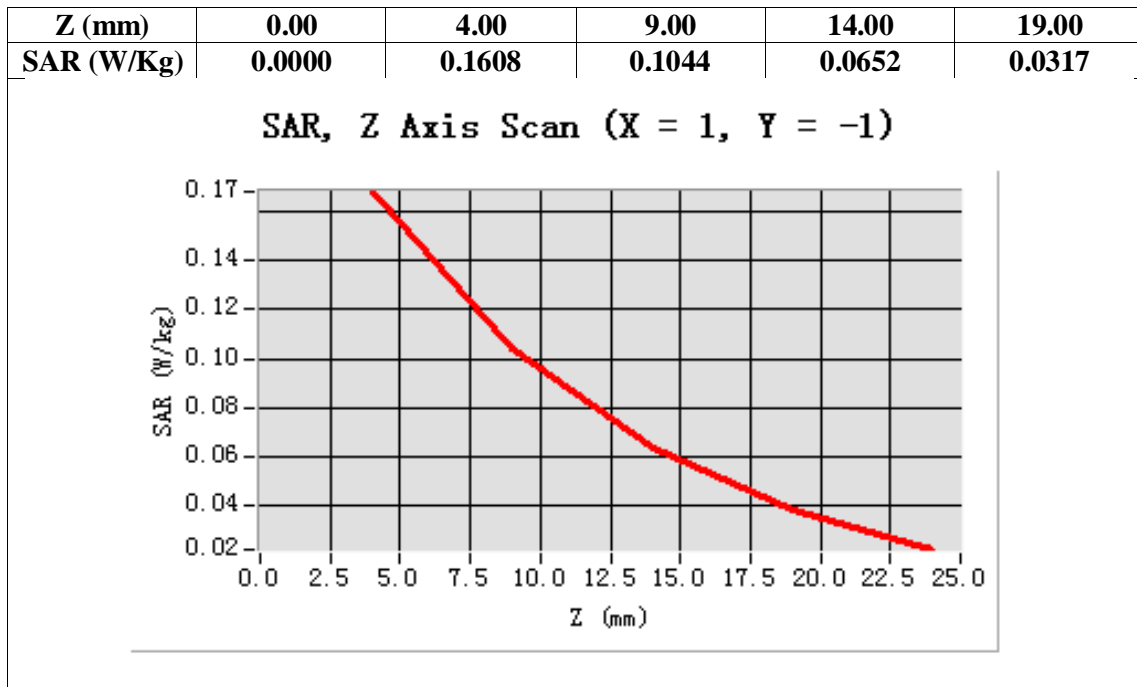

Test Laboratory: AGC Lab  
Hotspot Mid-Body -Front (DTS)  
**DUT: Mobile Phone; Type: QUE 5.0**

**Date: July 24,2014**

Communication System: Wi-Fi; Communication System Band: Hotspot; Duty Cycle: 1:1; Conv.F=4.31;  
Frequency: 2437 MHz; Medium parameters used:  $f = 2450$  MHz;  $\sigma = 1.87$  mho/m;  $\epsilon_r = 52.55$ ;  $\rho = 1000$  kg/m<sup>3</sup> ;  
Phantom section: Flat Section  
Ambient temperature (°C):21, Liquid temperature (°C):21

**SATIMO Configuration:**

- Probe: SSE5; Calibrated: 01/12/2014; Serial No.:SN 22/12 EP159
- Sensor-Surface: 4mm (Mechanical Surface Detection)
- Phantom: Flat Phantom; Type: Elliptical Phantom
- Measurement SW: OpenSAR V4\_02\_01

**Configuration/Hotspot Mid-Body- Front /Area Scan:** Measurement grid: dx=8mm, dy=8mm  
**Configuration/Hotspot Mid-Body- Front /Zoom Scan:** Measurement grid: dx=8mm, dy=8mm, dz=5mm;

<b>Area Scan</b>	surf_sam_plan.txt
<b>ZoomScan</b>	5x5x7,dx=8mm dy=8mm dz=5mm,Very fast
<b>Phantom</b>	Validation plane
<b>Device Position</b>	Body Front
<b>Band</b>	2450MHz
<b>Channels</b>	Middle
<b>Signal</b>	TDMA (Crest factor: 8.0)

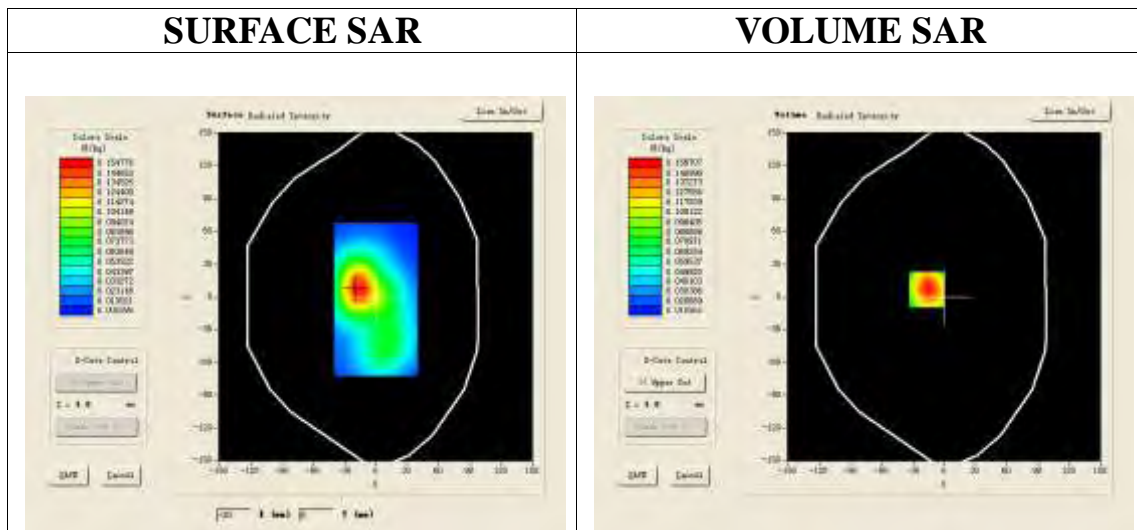

**Maximum location: X=-17.00, Y=7.00**

<b>SAR 10g (W/Kg)</b>	0.092736
<b>SAR 1g (W/Kg)</b>	0.155912

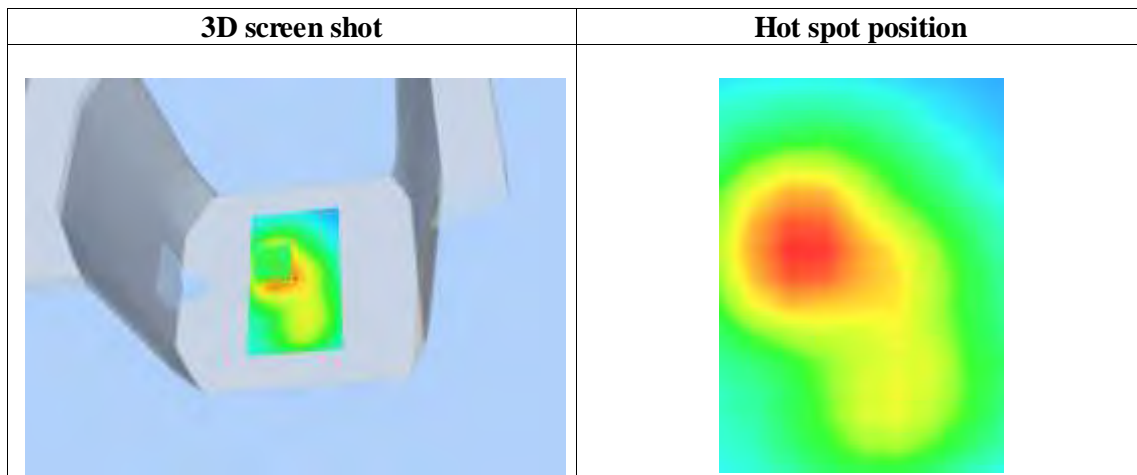
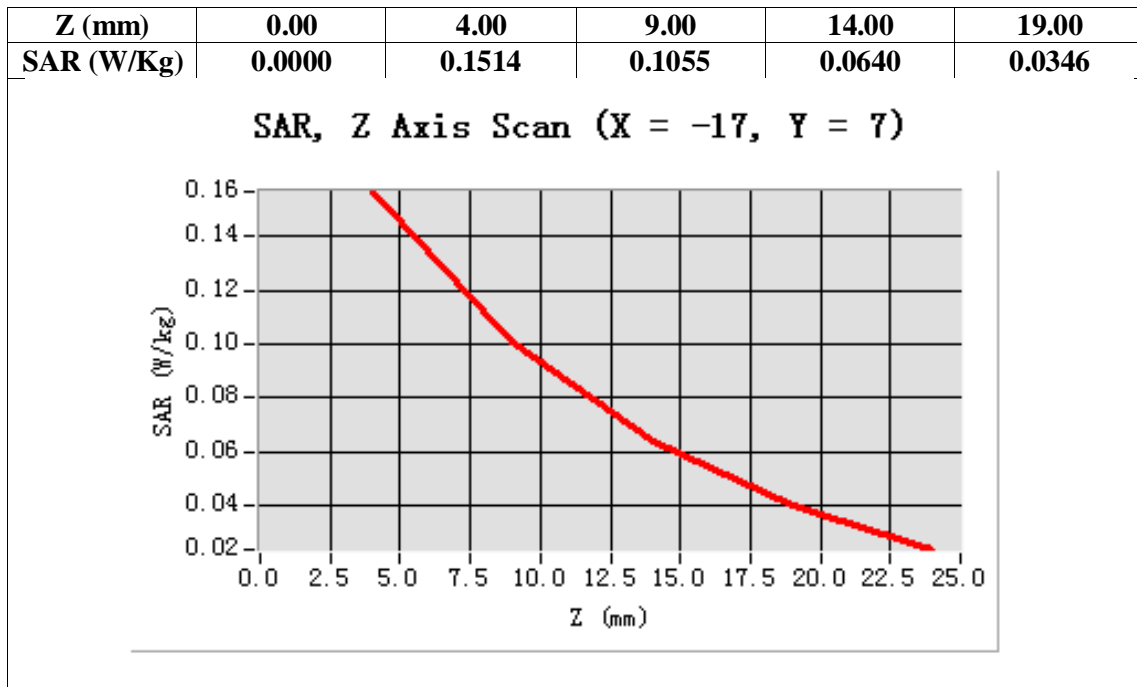



**Repeated SAR**

Test Laboratory: AGC Lab

Date: July 24,2014

WCDMA Band II Mid-Touch-Right (RMC)

DUT: Mobile Phone; Type: QUE 5.0

Communication System: UMTS; Communication System Band: Band II UTRA/FDD ;Duty Cycle:1:1; Conv.F=4.51  
Frequency: 1880 MHz; Medium parameters used:  $f = 1900$  MHz;  $\sigma = 1.42$  mho/m;  $\epsilon_r = 40.41$ ;  $\rho = 1000$  kg/m<sup>3</sup> ;  
Phantom section: Right Section  
Ambient temperature (°C):21, Liquid temperature (°C):21

SATIMO Configuration:

- Probe: SSE5; Calibrated: 01/12/2014; Serial No.:SN 22/12 EP159
- Sensor-Surface: 4mm (Mechanical Surface Detection)
- Phantom: Flat Phantom; Type: Elliptical Phantom
- Measurement SW: OpenSAR V4\_02\_01

Configuration/ WCDMA band II Mid-Touch-Right/Area Scan: Measurement grid: dx=8mm, dy=8mm

Configuration/ WCDMA band II Mid-Touch-Right/Zoom Scan: Measurement grid: dx=8mm, dy=8mm, dz=5mm;

Area Scan	sam_direct_droit2_surf8mm.txt
ZoomScan	5x5x7,dx=8mm dy=8mm dz=5mm,Very fast
Phantom	Right head
Device Position	Cheek
Band	WCDMA band II
Channels	Middle
Signal	TDMA (Crest factor: 1.0)

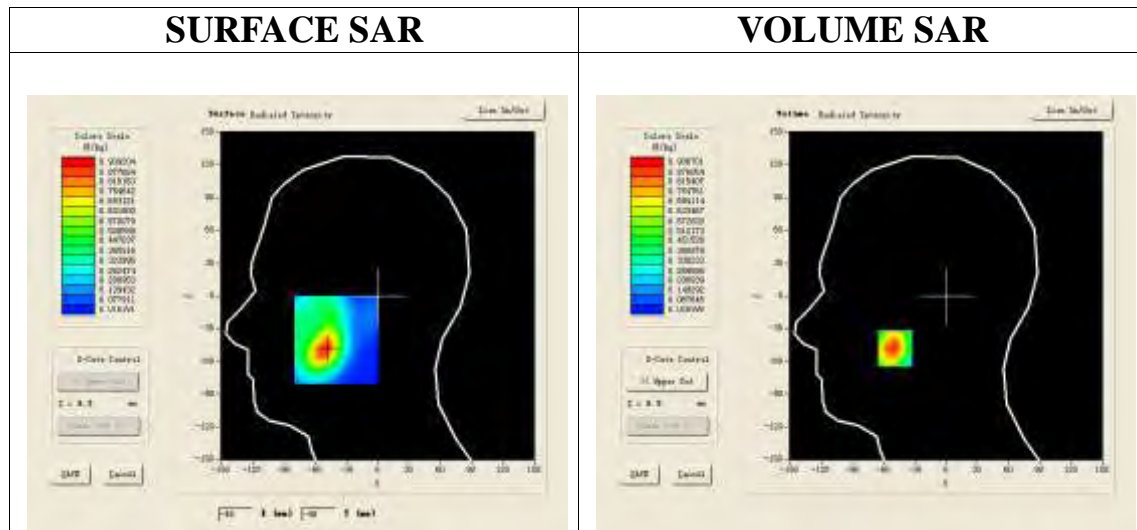

**Maximum location: X=-49.00, Y=-48.00**

<b>SAR 10g (W/Kg)</b>	0.502063
<b>SAR 1g (W/Kg)</b>	0.868937

Z (mm)	0.00	4.00	9.00	14.00	19.00
SAR (W/Kg)	0.0000	0.9162	0.5759	0.3561	0.2234

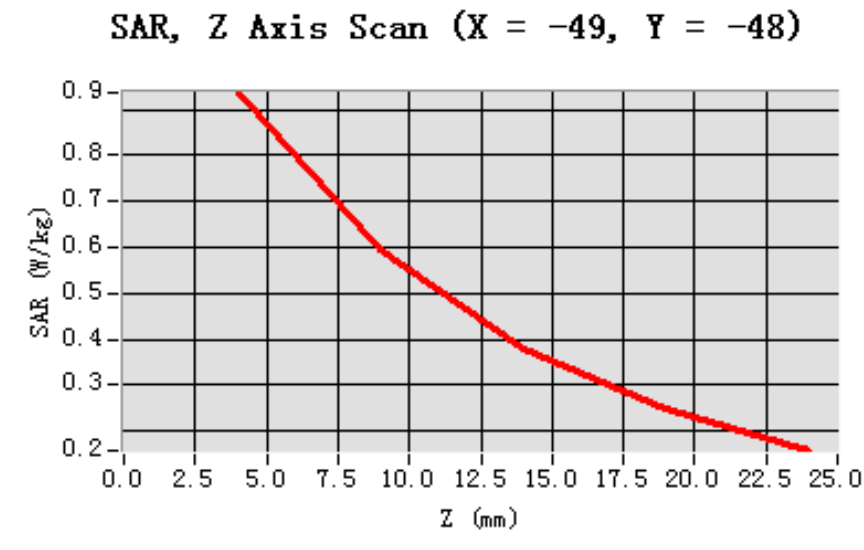

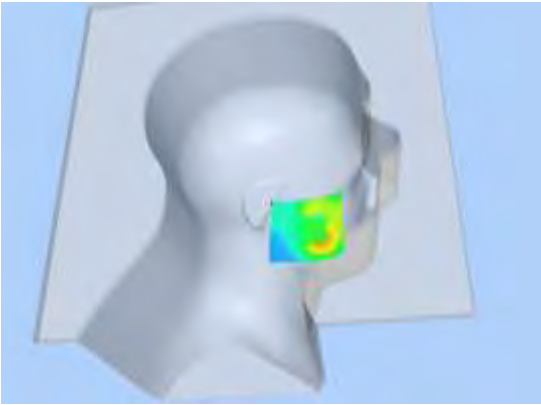
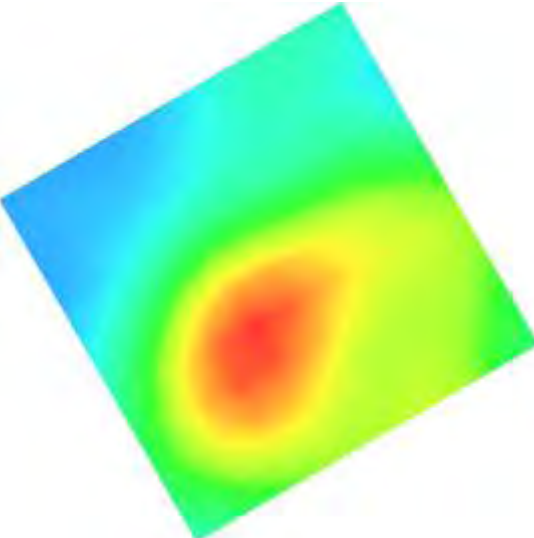
3D screen shot	Hot spot position
	

Test Laboratory: AGC Lab

Date: July 24,2014

WCDMA Band II Mid-Body-Towards Grounds (RMC 12.2kbps)

DUT: Mobile Phone; Type: QUE 5.0

Communication System: UMTS; Communication System Band: Band II UTRA/FDD ;Duty Cycle:1:1; Conv.F=4.45  
Frequency: 1880 MHz; Medium parameters used:  $f = 1900$  MHz;  $\sigma=1.53$  mho/m;  $\epsilon_r =53.79$ ;  $\rho= 1000$  kg/m<sup>3</sup> ;  
Phantom section: Flat Section  
Ambient temperature (°C):21, Liquid temperature (°C):21

SATIMO Configuration:

- Probe: SSE5; Calibrated: 01/12/2014; Serial No.:SN 22/12 EP159
- Sensor-Surface: 4mm (Mechanical Surface Detection)
- Phantom: Flat Phantom; Type: Elliptical Phantom
- Measurement SW: OpenSAR V4\_02\_01

Configuration/ WCDMA band II Mid-Body-back/Area Scan: Measurement grid: dx=8mm, dy=8mm

Configuration/ WCDMA band II Mid-Body-back/Zoom Scan: Measurement grid: dx=8mm, dy=8mm, dz=5mm;

Area Scan	surf_sam_plan.txt
ZoomScan	5x5x7,dx=8mm dy=8mm dz=5mm,Very fast
Phantom	Validation plane
Device Position	Body Back
Band	WCDMA band II
Channels	Middle
Signal	TDMA (Crest factor: 1.0)

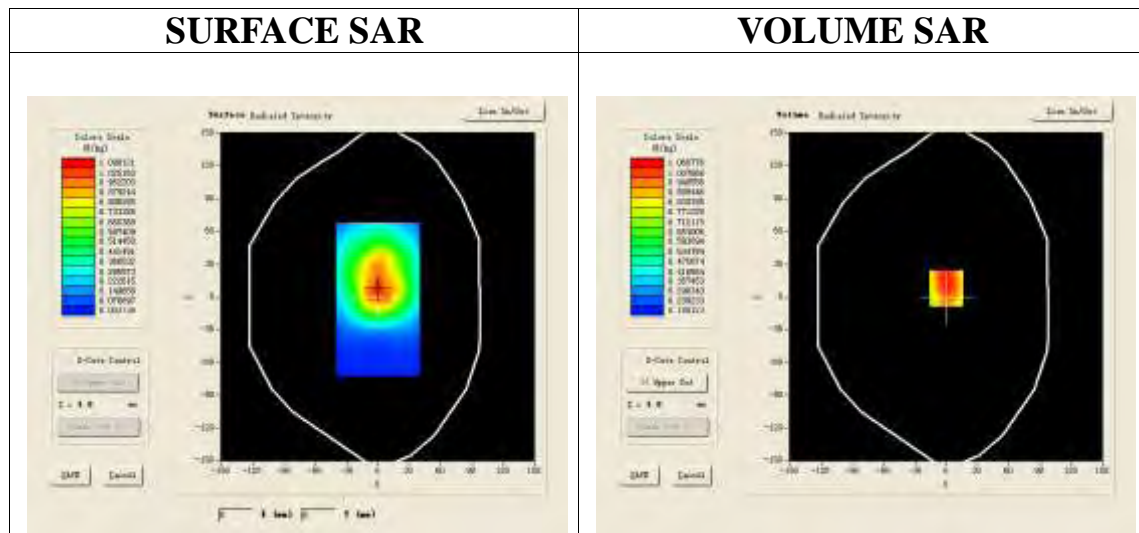

Maximum location: X=0.00, Y=8.00

SAR 10g (W/Kg)	0.751354
SAR 1g (W/Kg)	1.096438

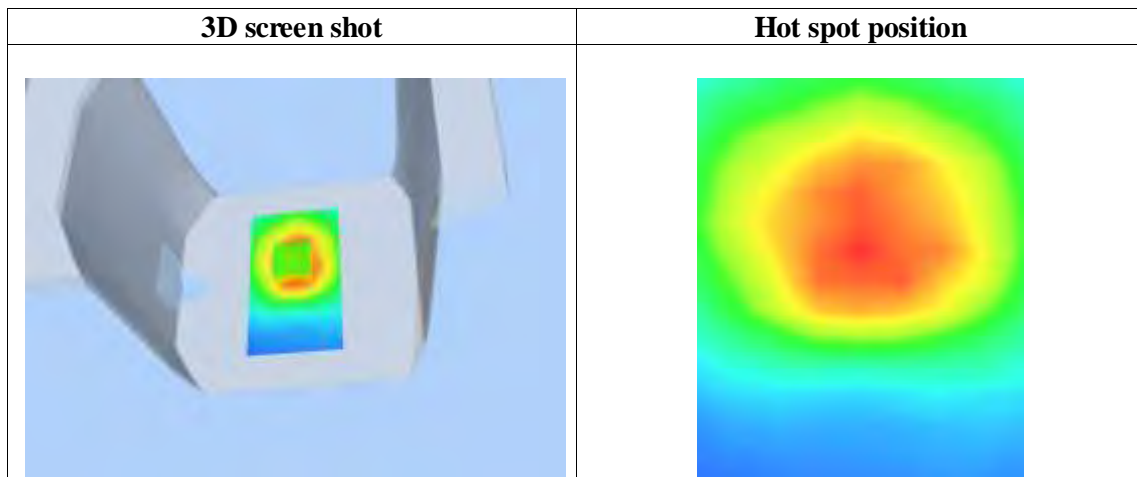
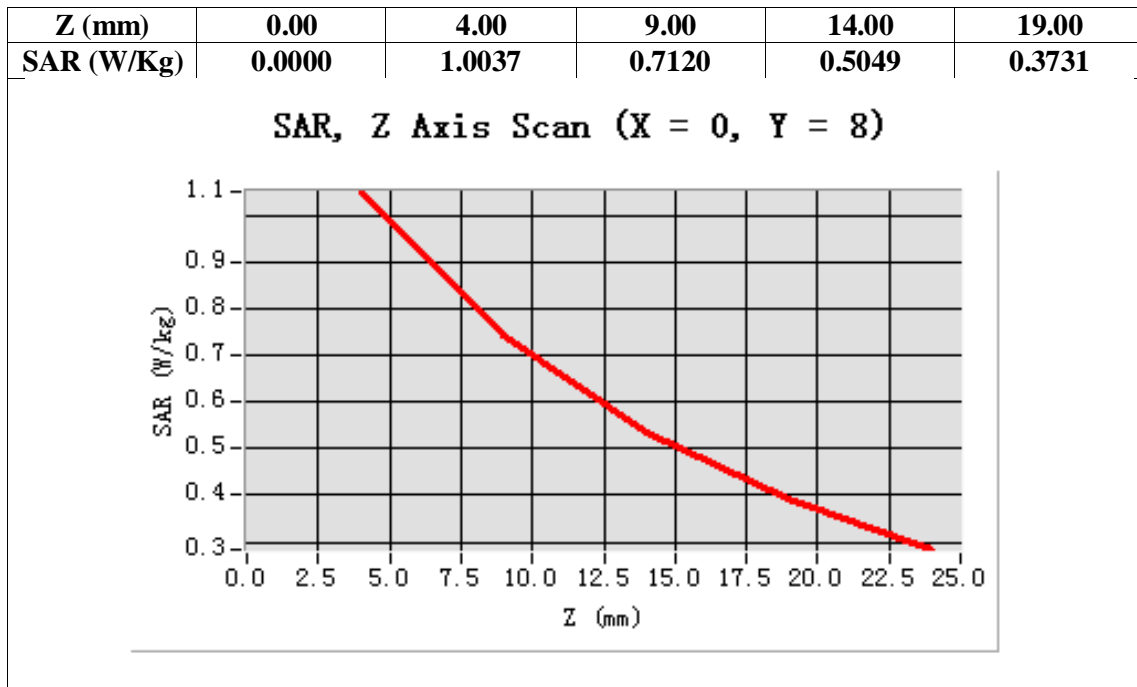

Test Laboratory: AGC Lab

Date: July 24,2014

WCDMA Band V Mid-Body-Towards Grounds (RMC)

DUT: Mobile Phone; Type: QUE 5.0

Communication System: UMTS; Communication System Band: BAND V UTRA/FDD; Duty Cycle:1: 1; Conv.F=5.48  
Frequency: 836.6 MHz; Medium parameters used:  $f = 835$  MHz;  $\sigma=0.96$  mho/m;  $\epsilon_r = 55.76$ ;  $\rho = 1000$  kg/m<sup>3</sup> ;  
Phantom section: Flat Section  
Ambient temperature (°C):21, Liquid temperature (°C):21

SATIMO Configuration:

- Probe: SSE5; Calibrated: 01/12/2014; Serial No.:SN 22/12 EP159
- Sensor-Surface: 4mm (Mechanical Surface Detection)
- Phantom: Flat Phantom; Type: Elliptical Phantom
- Measurement SW: OpenSAR V4\_02\_01

Configuration/ WCDMA Band V Mid-Body-Back/Area Scan (6x8x1): Measurement grid: dx=8mm, dy=8mm  
Configuration/ WCDMA Band V Mid-Body-Back/Zoom Scan (5x5x7)/Cube 0: Measurement grid:  
dx=8mm,dy=8mm, dz=5mm;

Area Scan	surf_sam_plan.txt
ZoomScan	5x5x7,dx=8mm dy=8mm dz=5mm,Very fast
Phantom	Validation plane
Device Position	Body Back
Band	WCDMA Band V
Channels	Middle
Signal	TDMA (Crest factor: 1.0)

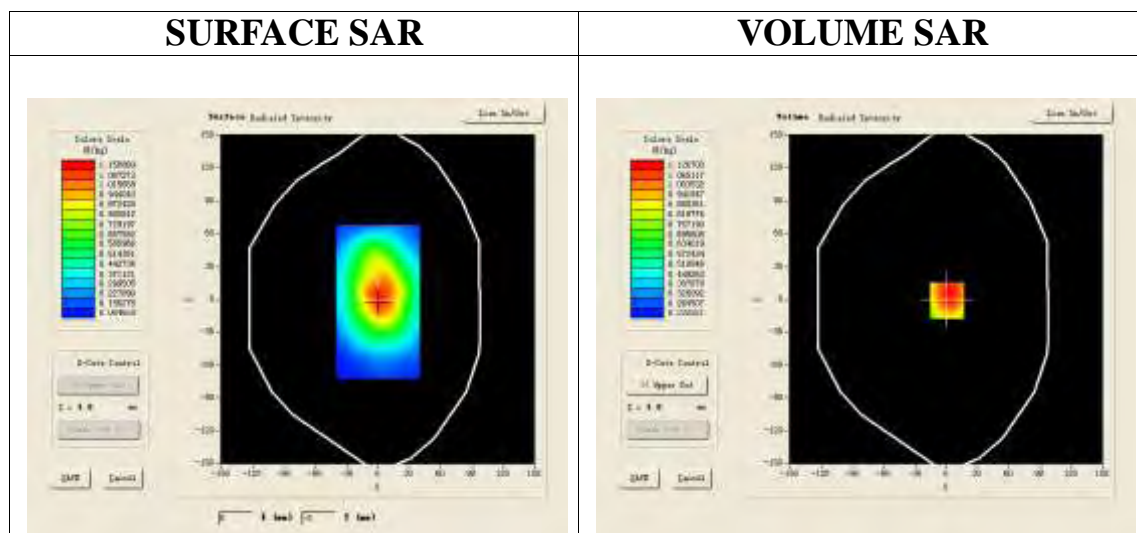

Maximum location: X=1.00, Y=-1.00

SAR 10g (W/Kg)	0.823469
SAR 1g (W/Kg)	1.168495

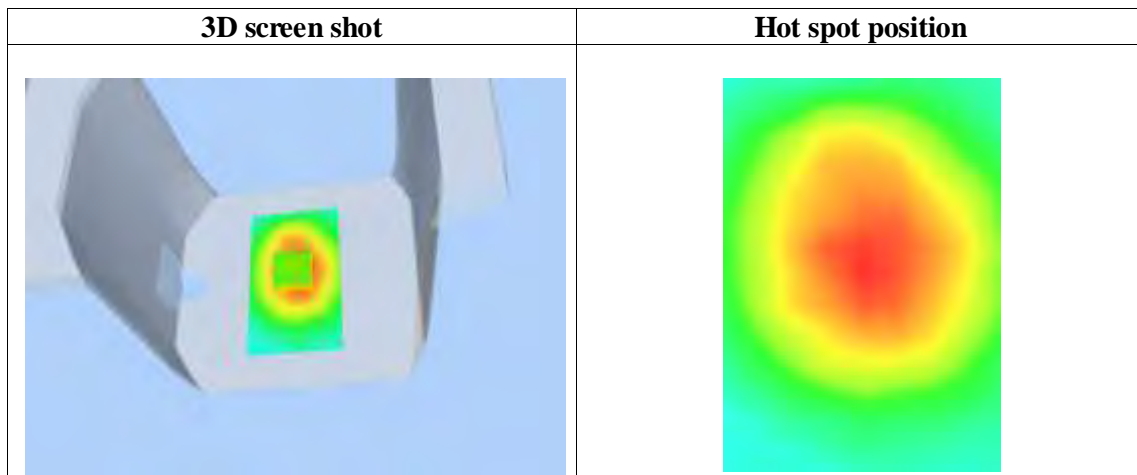
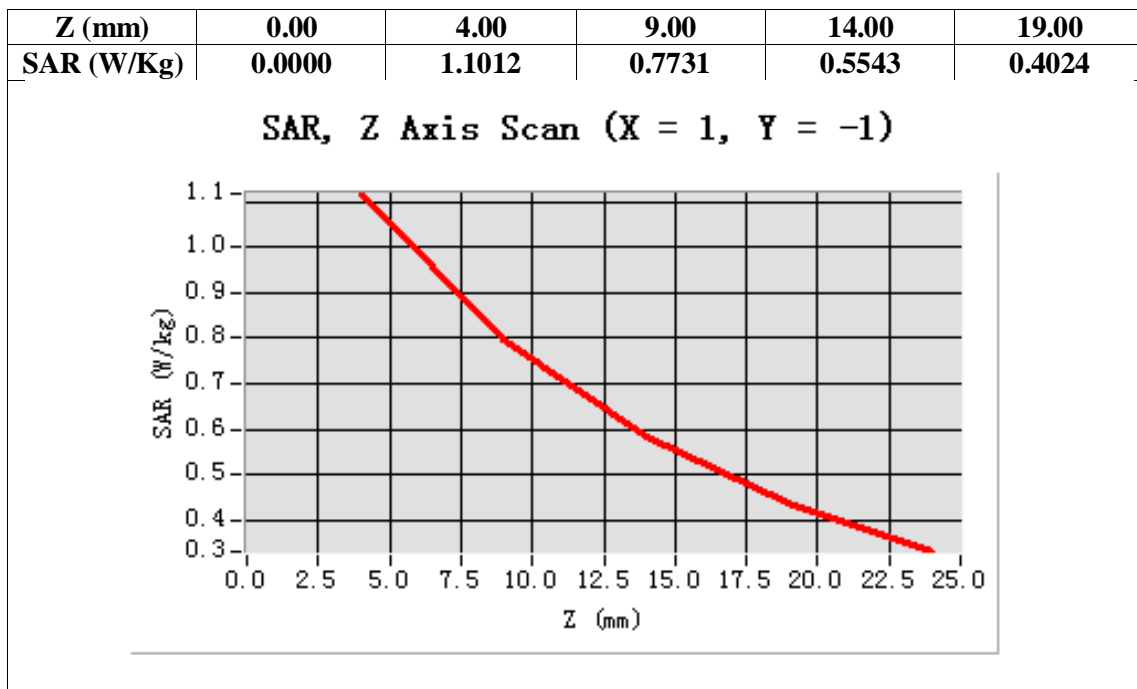

Test Laboratory: AGC Lab  
WCDMA Band IV Low-Body-Towards Grounds (RMC)  
DUT: Mobile Phone; Type: QUE 5.0

Date: July 24,2014

Communication System: UMTS; Communication System Band: BAND IV UTRA/FDD; Duty Cycle:1: 1; Conv.F=4.71  
Frequency: 1712.4 MHz; Medium parameters used:  $f = 1700\text{MHz}$ ;  $\sigma = 1.49 \text{ mho/m}$ ;  $\epsilon_r = 53.18$ ;  $\rho = 1000 \text{ kg/m}^3$  ;  
Phantom section: Flat Section  
Ambient temperature ( $^{\circ}\text{C}$ ):21, Liquid temperature ( $^{\circ}\text{C}$ ):21

SATIMO Configuration:

- Probe: SSE5; Calibrated: 01/12/2014; Serial No.:SN 22/12 EP159
- Sensor-Surface: 4mm (Mechanical Surface Detection)
- Phantom: Flat Phantom; Type: Elliptical Phantom
- Measurement SW: OpenSAR V4\_02\_01

Configuration/ WCDMA Band IV Low-Body-Back/Area Scan (6x8x1): Measurement grid:  $dx=8\text{mm}$ ,  $dy=8\text{mm}$   
Configuration/ WCDMA Band IV Low-Body-Back/Zoom Scan (5x5x7)/Cube 0: Measurement grid:  $dx=8\text{mm}$ , $dy=8\text{mm}$ ,  $dz=5\text{mm}$ ;

Area Scan	surf_sam_plan.txt
ZoomScan	5x5x7,dx=8mm dy=8mm dz=5mm,Very fast
Phantom	Validation plane
Device Position	Body Back
Band	WCDMA Band IV
Channels	Low
Signal	TDMA (Crest factor: 1.0)

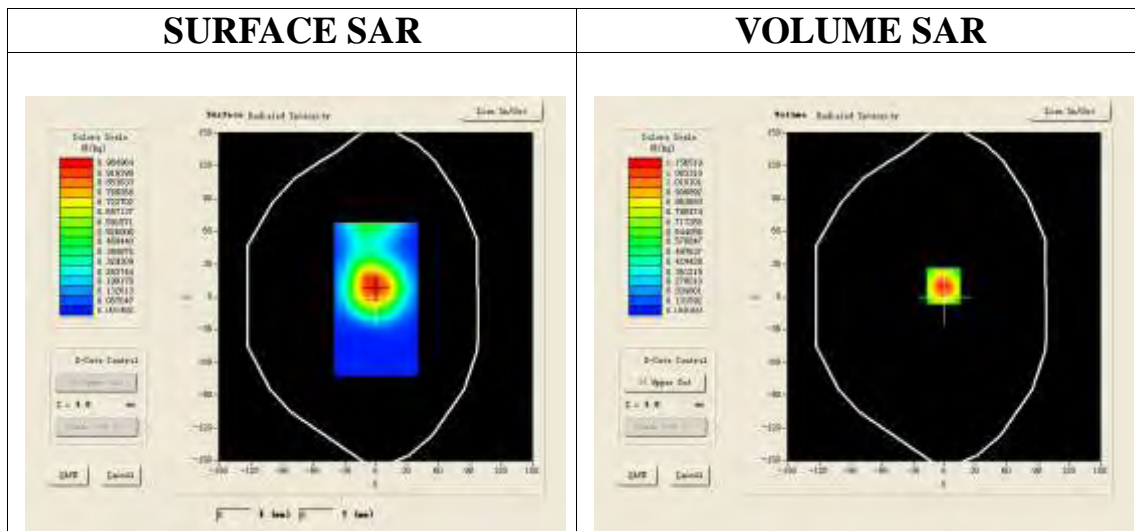

Maximum location: X=-1.00, Y=10.00

SAR 10g (W/Kg)	0.660315
SAR 1g (W/Kg)	1.171496

