



FCC- TEST REPORT

Report Number : **68.930.17.455.01** Date of Issue: November 22, 2017

Model : **MD41W0, MD41W1**

Product Type : Digital Automatic Blood Pressure Monitor

Applicant : Grandway Technology (Shenzhen) Limited

Address : Block 7, Zhu Keng Industrial Zone,
Ping Shan District, 518118 Shenzhen
PEOPLE'S REPUBLIC OF CHINA

Production Facility : Grandway Technology (Shenzhen) Limited

Address : Block 7, Zhu Keng Industrial Zone,
Ping Shan District, 518118 Shenzhen
PEOPLE'S REPUBLIC OF CHINA

Test Result : **Positive** **Negative**

Total pages including Appendices : 48

TÜV SÜD Certification and Testing (China) Co., Ltd. Shenzhen Branch is a subcontractor to TÜV SÜD Product Service GmbH according to the principles outlined in ISO 17025.

TÜV SÜD Certification and Testing (China) Co., Ltd. Shenzhen Branch reports apply only to the specific samples tested under stated test conditions. Construction of the actual test samples has been documented. It is the manufacturer's responsibility to assure that additional production units of this model are manufactured with identical electrical and mechanical components. The manufacturer/importer is responsible to the Competent Authorities in Europe for any modifications made to the production units which result in non-compliance to the relevant regulations. TÜV SÜD Certification and Testing (China) Co., Ltd. Shenzhen Branch shall have no liability for any deductions, inferences or generalizations drawn by the client or others from TÜV SÜD Certification and Testing (China) Co., Ltd. Shenzhen Branch issued reports.

This report is the confidential property of the client. As a mutual protection to our clients, the public and ourselves, extracts from the test report shall not be reproduced except in full without our written approval



1 Table of Contents

1	Table of Contents.....	2
2	Details about the Test Laboratory	3
3	Description of the Equipment under Test	4
4	Summary of Test Standards.....	5
5	Summary of Test Results	6
6	General Remarks.....	7
7	Test Setups.....	8
8	Systems test configuration	9
9	Technical Requirement	10
9.1	Conducted Emission	10
9.2	Conducted peak output power	13
9.3	6dB bandwidth	14
9.4	Power spectral density	20
9.5	Spurious RF conducted emissions	26
9.6	Band edge	36
9.7	Spurious radiated emissions for transmitter	40
10	Test Equipment List.....	47
11	System Measurement Uncertainty	48



2 Details about the Test Laboratory

Details about the Test Laboratory

Test Site 1

Company name: TÜV SÜD Certification and Testing (China) Co., Ltd. Shenzhen Branch
Building 12&13, Zhiheng Wisdomland Business Park,
Nantou Checkpoint Road 2, Nanshan District,
Shenzhen City, 518052,
P. R. China

FCC Registration Number: 502708

Telephone: 86 755 8828 6998
Fax: 86 755 8828 5299

3 Description of the Equipment under Test

Description of the Equipment Under Test

Product:	Digital Automatic Blood Pressure Monitor
Model no.:	MD41W0
FCC ID:	2ABAFMD41WX
Options and accessories:	NIL
Rating:	6VDC (4x1.5V AAA batteries) or 6.0Vdc, 600mA (supplied by a separate approved AC/DC adaptor) AC/DC adaptor (M/N: UES06WNCP-060100SPA, manufactured by DONGGUAN SHILONG FUHUA ELECTRONIC CO., LTD) with following ratings: Input: 100-240VAC, 50/60Hz, 0.2A; Output: 6.0VDC, 1.0A
RF Transmission Frequency:	2412-2462MHz
No. of Operated Channel:	11
Modulation:	CCK, DQPSK, DBPSK for 802.11b QPSK,BPSK for 802.11g/n
Antenna Type:	PCB Antenna
Antenna Gain:	0dBi
Description of the EUT:	The Equipment Under Test (EUT) is a Digital Automatic Blood Pressure Monitor with WIFI function operating at 2.4GHz



4 Summary of Test Standards

Test Standards	
FCC Part 15 Subpart C 10-1-2016 Edition	PART 15 - RADIO FREQUENCY DEVICES Subpart C - Intentional Radiators

All the test methods were according to KDB558074 v4.0 DTS Measurement Guidance and ANSI C63.10 (2013).

5 Summary of Test Results

Technical Requirements				
FCC Part 15 Subpart C				
Test Condition		Pages	Test Result	Test Site
§15.207	Conducted emission AC power port	10	Pass	Site 1
§15.247(b)(1)	Conducted peak output power	13	Pass	Site 1
§15.247(e)	Power spectral density	14	Pass	Site 1
§15.247(a)(2)	6dB bandwidth	20	Pass	Site 1
§15.247(a)(1)	20dB bandwidth	--	N/A	--
§15.247(a)(1)	Carrier frequency separation	--	N/A	--
§15.247(a)(1)(iii)	Number of hopping frequencies	--	N/A	--
§15.247(a)(1)(iii)	Dwell Time	--	N/A	--
§15.247(d)	Spurious RF conducted emissions	26	Pass	Site 1
§15.247(d)	Band edge	36	Pass	Site 1
§15.247(d) & §15.209	Spurious radiated emissions for transmitter and receiver	40	Pass	Site 1
§15.203	Antenna requirement	See note 1	Pass	--

Remark 1: N/A – Not Applicable.

Note 1: The EUT uses a permanently PCB antenna, which gain is 0dBi. According to §15.203, it is considered sufficiently to comply with the provisions of this section.

6 General Remarks

Remarks

Model MD41W0 and model MD41W1 are identical each other except the LCD display type (Positive type for model MD41W0 and Negative type for MD41W1), so the RF full tests are applied on model MD41W0, model MD41W1 is deemed to fulfill the RF requirement without further testing.

This submittal(s) (test report) is intended for FCC ID: 2ABAFMD41WX complies with Section 15.207, 15.205, 15.209, 15.247 of the FCC Part 15, Subpart C.

SUMMARY:

All tests according to the regulations cited on page 5 were

- Performed

- **Not** Performed

The Equipment under Test

- **Fulfills** the general approval requirements.

- **Does not** fulfill the general approval requirements.

Sample Received Date: October 20, 2017

Testing Start Date: October 25, 2017

Testing End Date: November 21, 2017

- TÜV SÜD Certification and Testing (China) Co., Ltd. Shenzhen Branch -

Reviewed by:

Reviewed by:





Trevor You
Senior Project Engineer

Ricky Yin
EMC Project Engineer

7 Test Setups

7.1 Radiated test setups

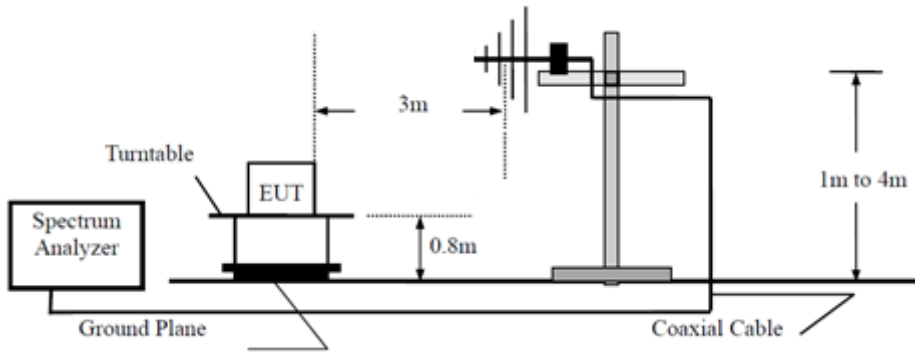
Below 1GHz



Above 1GHz

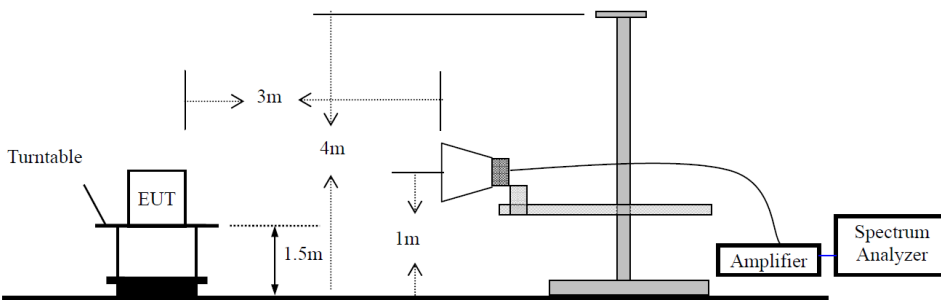

7.2 Conducted RF test setups

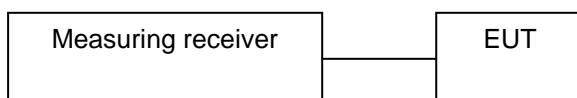

7.3 AC Power Line Conducted Emission test setups

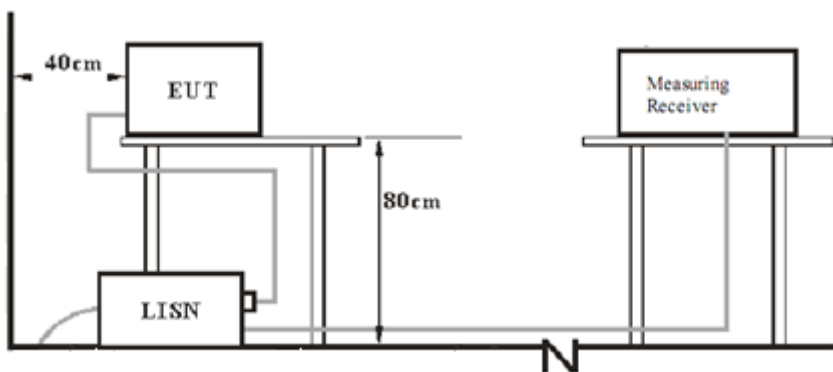

8 Systems test configuration

Auxiliary Equipment Used during Test:

DESCRIPTION	MANUFACTURER	MODEL NO.(SHIELD)	S/N(LENGTH)
---	---	---	---

Test software: RF test tool

The system was configured to channel 1, 6 and 11 for the test.

9 Technical Requirement

9.1 Conducted Emission

Test Method

1. The EUT was placed on a table, which is 0.8m above ground plane
2. The power line of the EUT is connected to the AC mains through a Artificial Mains Network (A.M.N.).
3. Maximum procedure was performed to ensure EUT compliance
4. A EMI test receiver is used to test the emissions from both sides of AC line

Limit

Frequency MHz	QP Limit dB μ V	AV Limit dB μ V
0.150-0.500	66-56*	56-46*
0.500-5	56	46
5-30	60	50

Decreasing linea

Conducted Emission

Product Type : Digital Automatic Blood Pressure Monitor
 M/N : MD41W0
 Operating Condition : TX
 Test Specification : Live
 Comment : AC 120V/60Hz

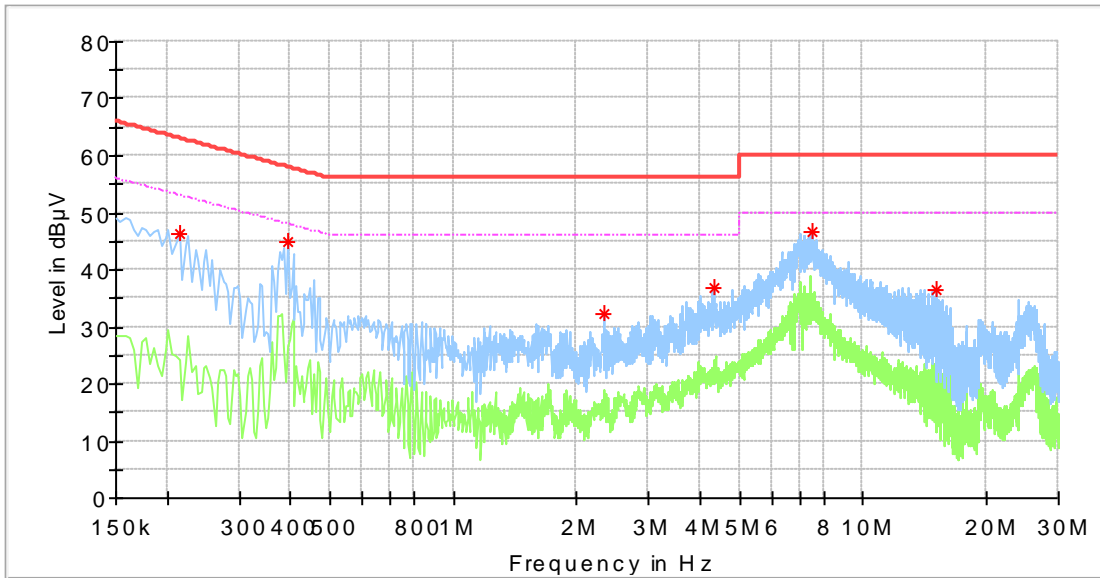

Critical Freqs

Frequency (MHz)	MaxPeak (dBµV)	Average (dBµV)	Limit (dBµV)	Margin (dB)	Line	Corr. * (dB)
0.214000	46.41	---	63.05	16.64	L1	10.2
0.394000	45.01	---	57.98	12.97	L1	11.5
2.334000	32.38	---	56.00	23.62	L1	10.3
4.334000	36.76	---	56.00	19.24	L1	10.4
7.502000	46.63	---	60.00	13.37	L1	10.5
15.058000	36.43	---	60.00	23.57	L1	10.7

Remark : “*” Correct factor=cable loss + LISN factor

Conducted Emission

Product Type : Digital Automatic Blood Pressure Monitor
 M/N : MD41W0
 Operating Condition : TX
 Test Specification : Neutral
 Comment : AC 120V/60Hz

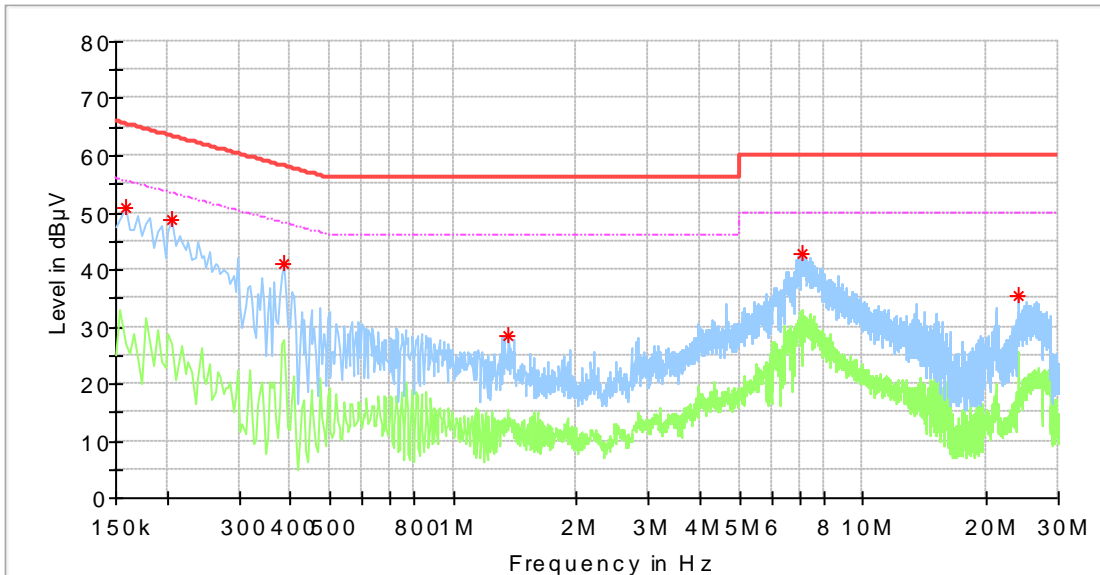

Critical Freqs

Frequency (MHz)	MaxPeak (dBµV)	Average (dBµV)	Limit (dBµV)	Margin (dB)	Line	Corr. * (dB)
0.158000	50.98	---	65.57	14.59	N	10.3
0.206000	48.69	---	63.37	14.68	N	10.3
0.386000	41.01	---	58.15	17.14	N	10.3
1.366000	28.42	---	56.00	27.58	N	10.4
7.094000	42.66	---	60.00	17.34	N	10.7
23.866000	35.42	---	60.00	24.58	N	11.8

Remark : “*” Correct factor=cable loss + LISN factor

9.2 Conducted Average output power

Test Method

1. Setting the highest output power level of the EUT:
2. Connect to gated RF average power meter.

Test Setup

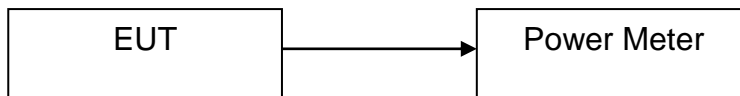

Limits

According to §15.247 (b) (3), conducted Average output power limit as below:

Frequency Range MHz	Limit W	Limit dBm
2400-2483.5	≤1	≤30

Test result as below table

802.11b

Frequency MHz	Conducted Average Output Power dBm	Result
Top channel 2412MHz	5.4	Pass
Middle channel 2437MHz	7.0	Pass
Bottom channel 2462MHz	7.3	Pass

802.11g

Frequency MHz	Conducted Average Output Power dBm	Result
Top channel 2412MHz	5.6	Pass
Middle channel 2437MHz	7.6	Pass
Bottom channel 2462MHz	6.3	Pass

802.11nHT20

Frequency MHz	Conducted Average Output Power dBm	Result
Top channel 2412MHz	4.6	Pass
Middle channel 2437MHz	6.6	Pass
Bottom channel 2462MHz	6.2	Pass

9.3 6dB bandwidth

Test Method

1. Use the following spectrum analyzer settings:
RBW=100K, VBW \geq 3RBW, Sweep = auto, Detector function = peak, Trace = max hold
2. Use the automatic bandwidth measurement capability of an instrument, may be employed using the X dB bandwidth mode with X set to 6 dB, care shall be taken so that the bandwidth measurement is not influenced by any intermediate power nulls in the fundamental emission that might be \geq 6 dB.
3. Allow the trace to stabilize, record the X dB Bandwidth value.

Limit

Limit [kHz]

\geq 500

Test result

802.11b

Frequency MHz	6dB bandwidth MHz	Result
Bottom channel 2412MHz	10.03	Pass
Middle channel 2437MHz	10.07	Pass
Top channel 2462MHz	10.03	Pass

802.11g

Frequency MHz	6dB bandwidth MHz	Result
Bottom channel 2412MHz	15.11	Pass
Middle channel 2437MHz	15.02	Pass
Top channel 2462MHz	15.11	Pass

802.11nHT20

Frequency MHz	6dB bandwidth MHz	Result
Bottom channel 2412MHz	15.07	Pass
Middle channel 2437MHz	15.07	Pass
Top channel 2462MHz	15.07	Pass

802.11b

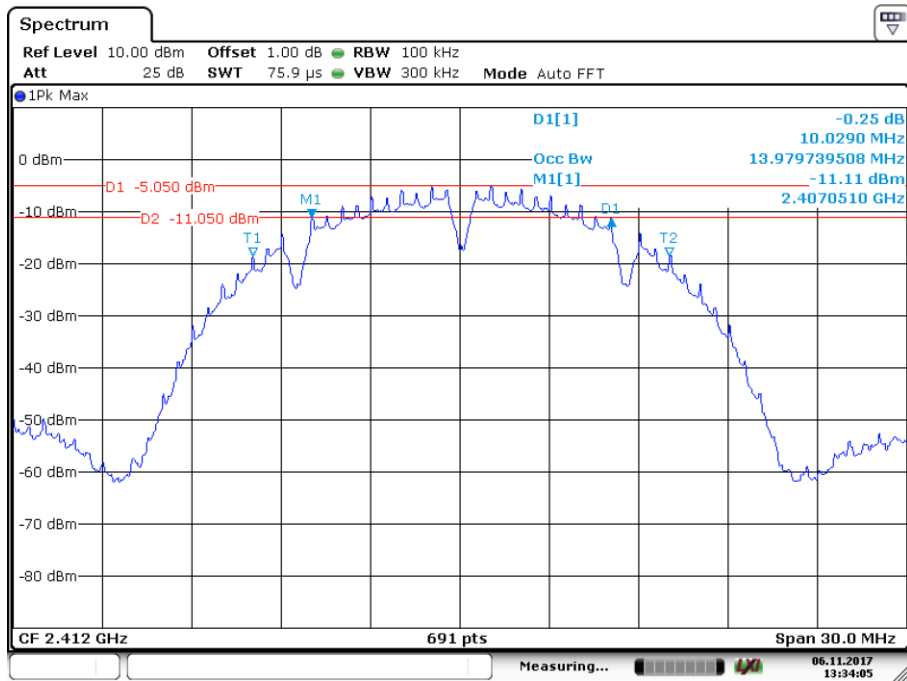

Date: 6.NOV.2017 13:34:06

2412MHz

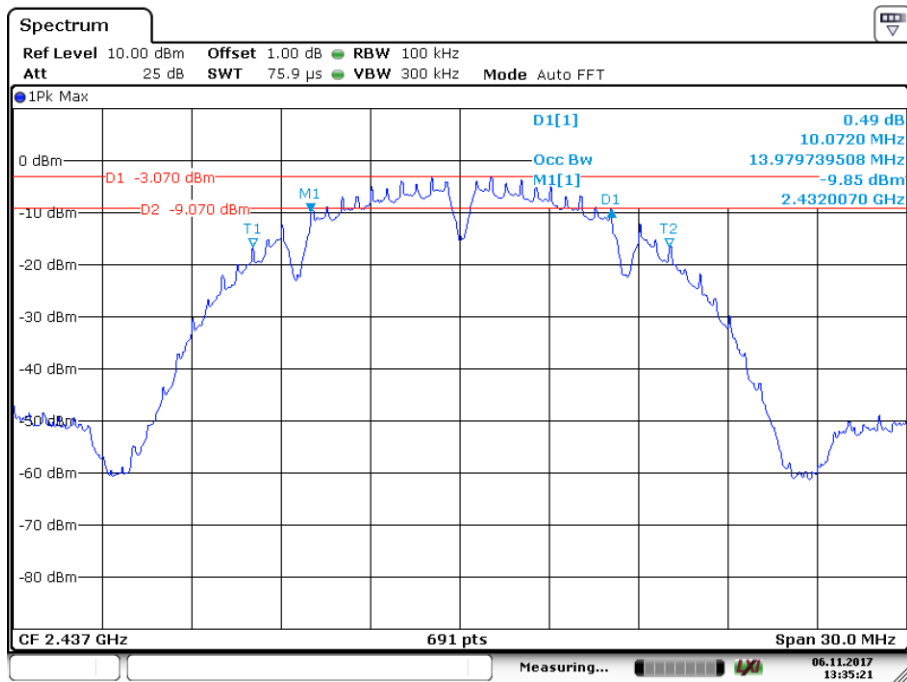

Date: 6.NOV.2017 13:35:21

2437MHz

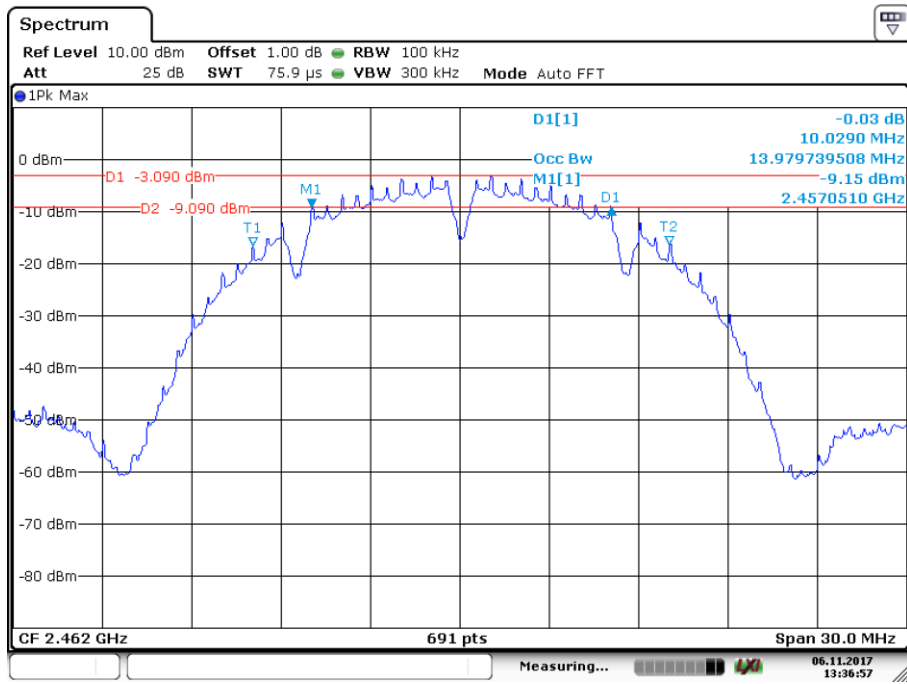

Date: 6.NOV.2017 13:36:57

2462MHz

802.11g

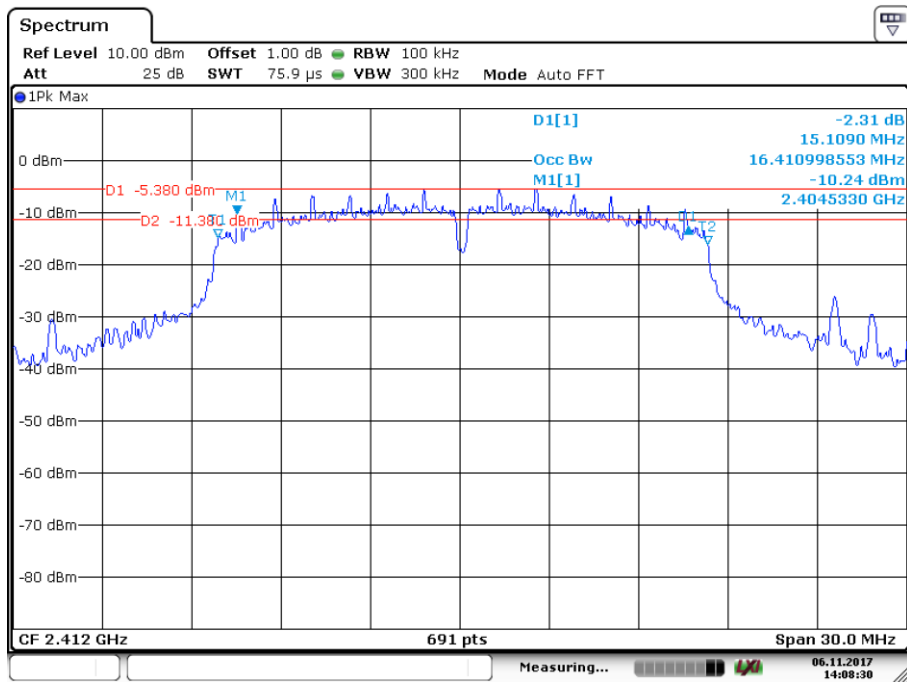

Date: 6.NOV.2017 14:08:29

2412MHz

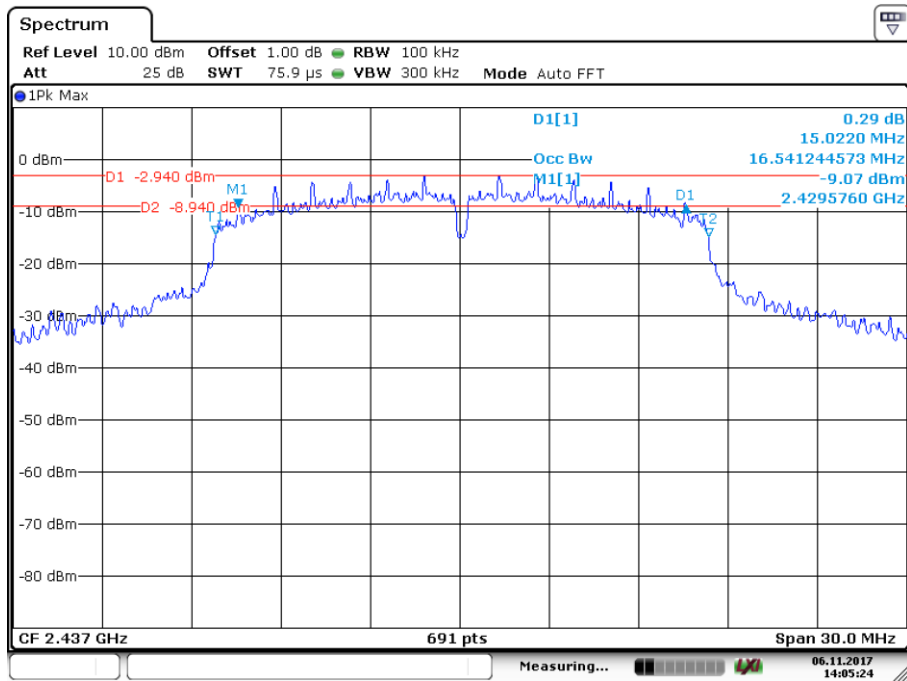

Date: 6. NOV. 2017 14:05:24

2437MHz

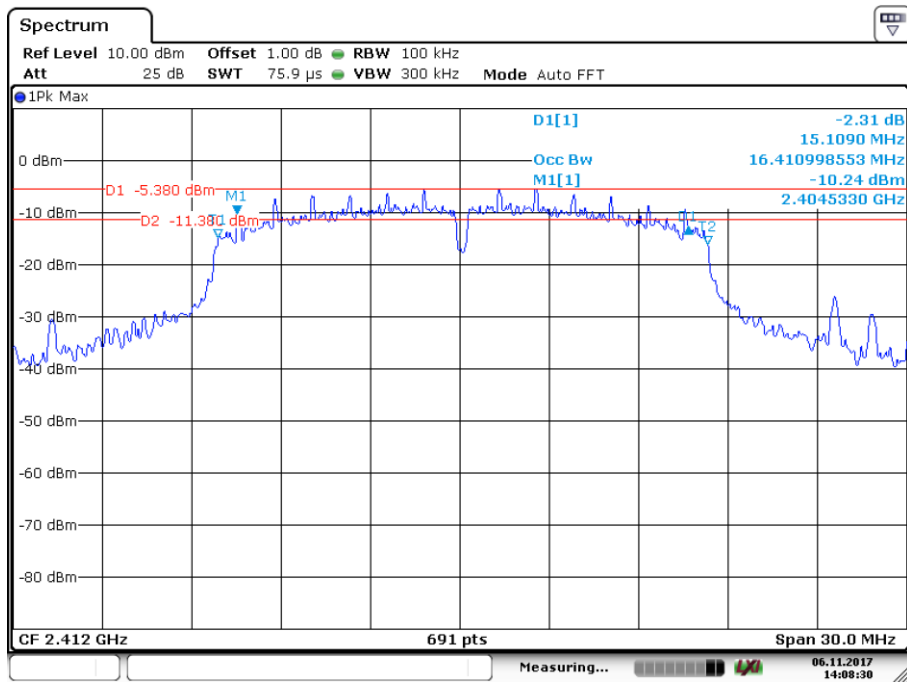

Date: 6. NOV. 2017 14:08:29

2462MHz

802.11nHT20

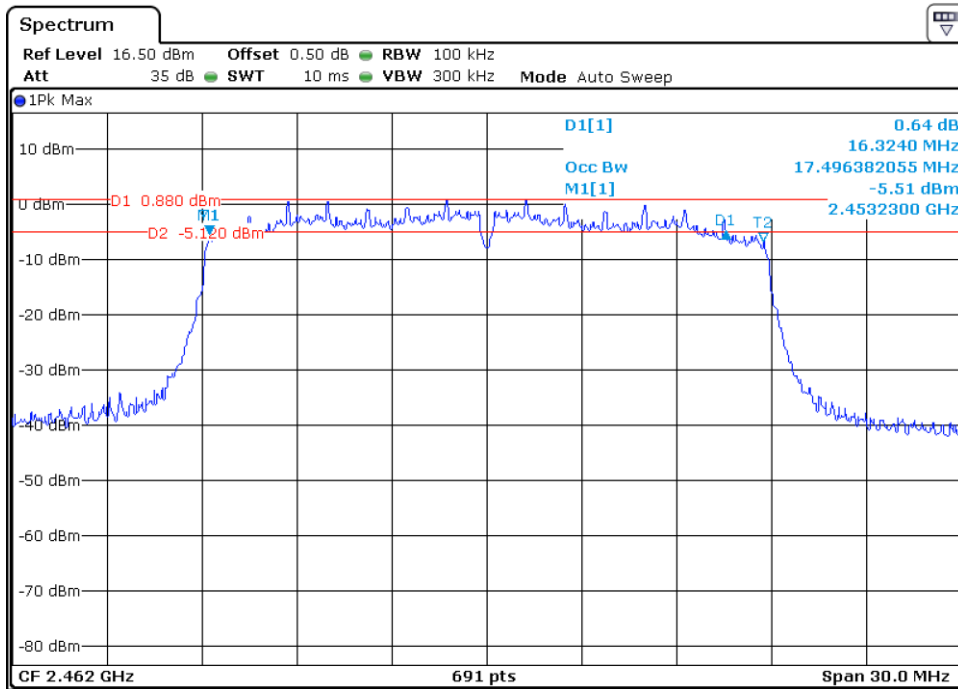

2412MHz

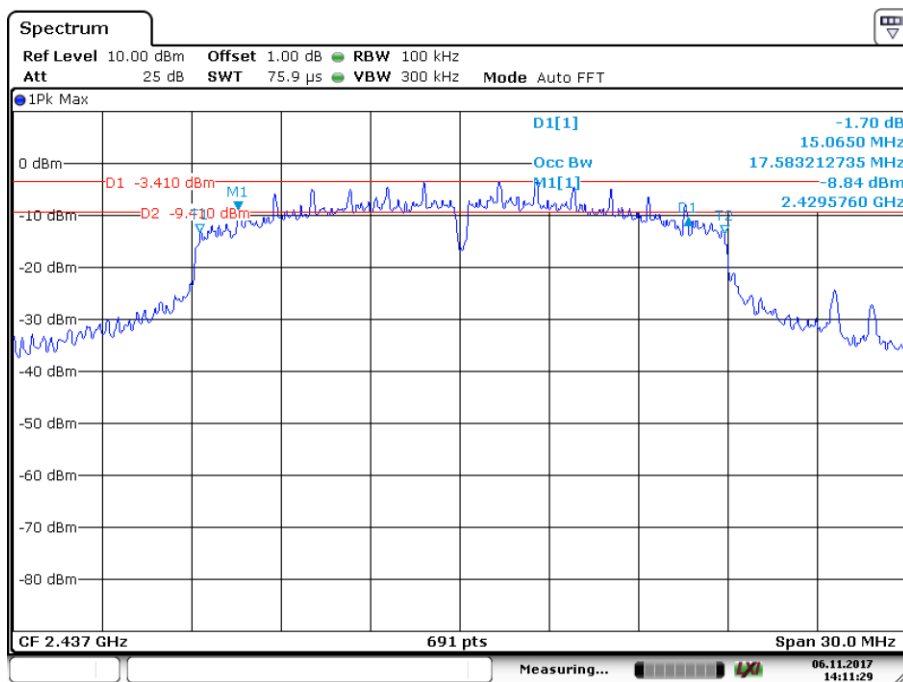

2437MHz

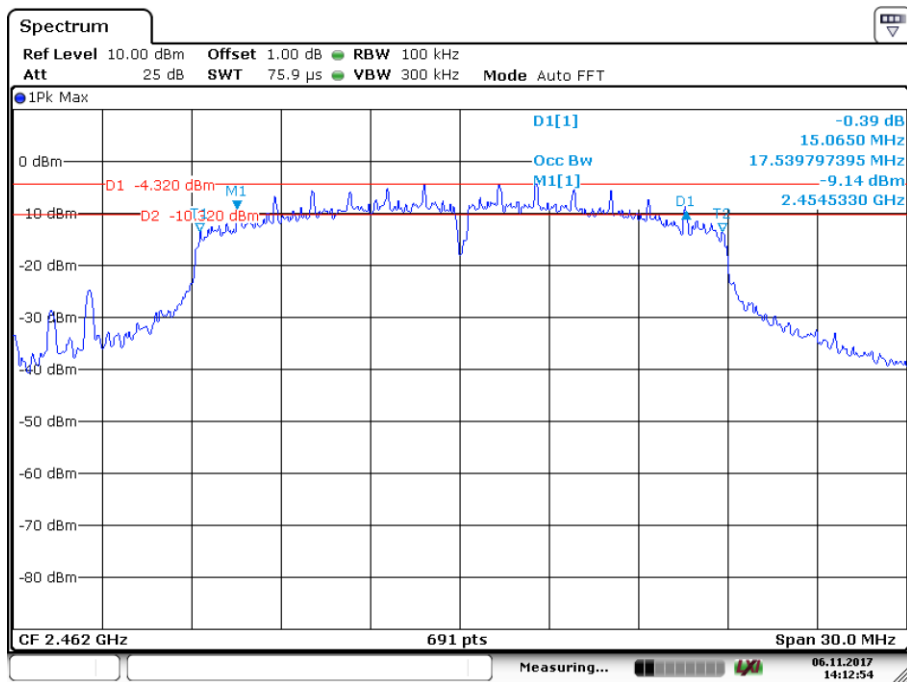

Date: 6.NOV.2017 14:12:55

2462MHz

9.4 Power spectral density

Test Method

This procedure shall be used if maximum peak conducted output power was used to demonstrate compliance:

1. Set analyzer center frequency to DTS channel center frequency. RBW=3kHz, VBW \geq 3RBW, Span=1.5 times DTS bandwidth, Detector=Peak, Sweep=auto, Trace= max hold.
2. Allow trace to fully stabilize, use the peak marker function to determine the maximum amplitude level within the RBW.
3. Repeat above procedures until other frequencies measured were completed.

Limit

Limit [dBm]

≤ 8

Test result

802.11b

Frequency MHz	Power spectral density dBm	Result
Top channel 2412MHz	-20.39	Pass
Middle channel 2437MHz	-18.60	Pass
Bottom channel 2462MHz	-18.39	Pass

802.11g

Frequency MHz	Power spectral density dBm	Result
Top channel 2412MHz	-20.85	Pass
Middle channel 2437MHz	-18.34	Pass
Bottom channel 2462MHz	-19.42	Pass

802.11nHT20

Frequency MHz	Power spectral density dBm	Result
Top channel 2412MHz	-20.11	Pass
Middle channel 2437MHz	-18.31	Pass
Bottom channel 2462MHz	-18.48	Pass

802.11b

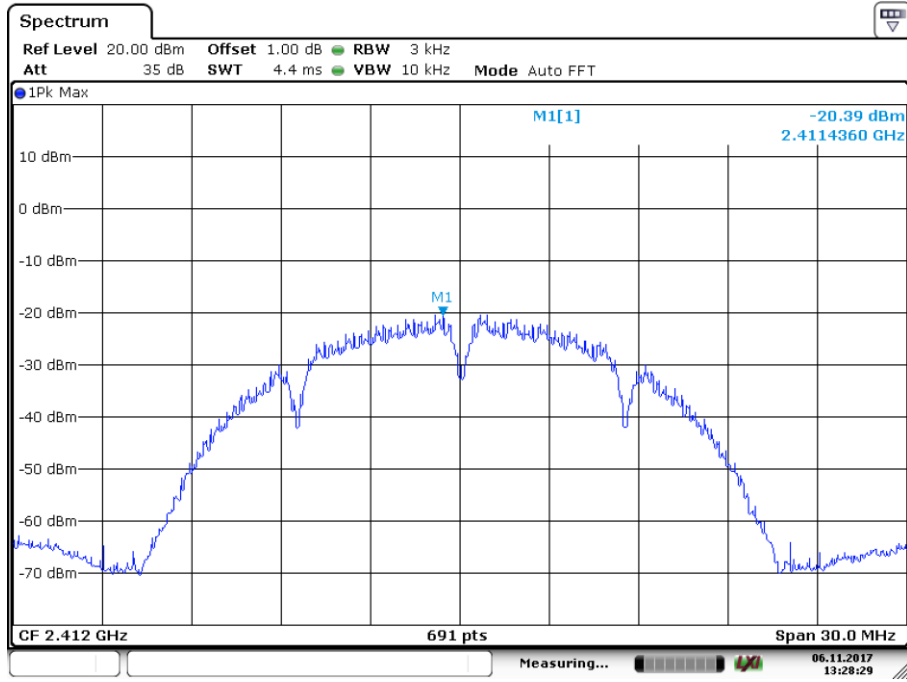

Date: 6 NOV. 2017 13:28:28

2412MHz

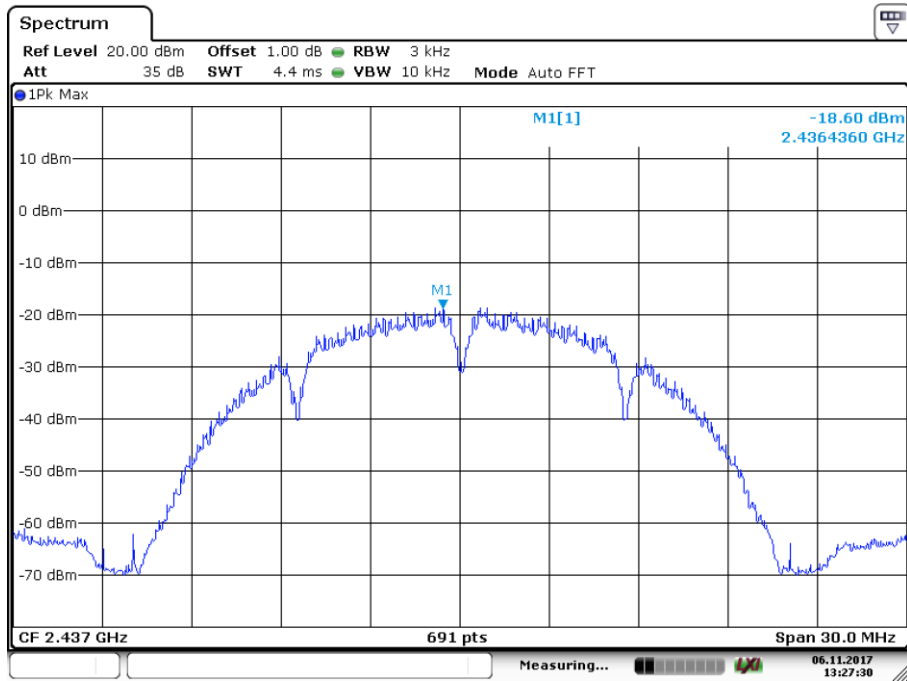

Date: 6 NOV. 2017 13:27:30

2437MHz

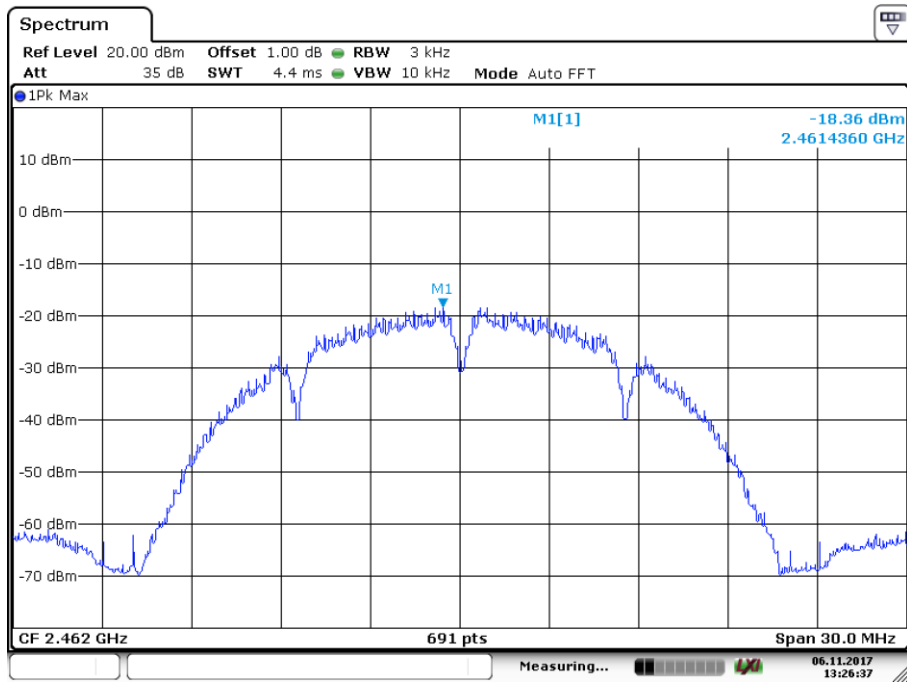

Date: 6. NOV. 2017 13:26:37

2462MHz

802.11g

2412MHz

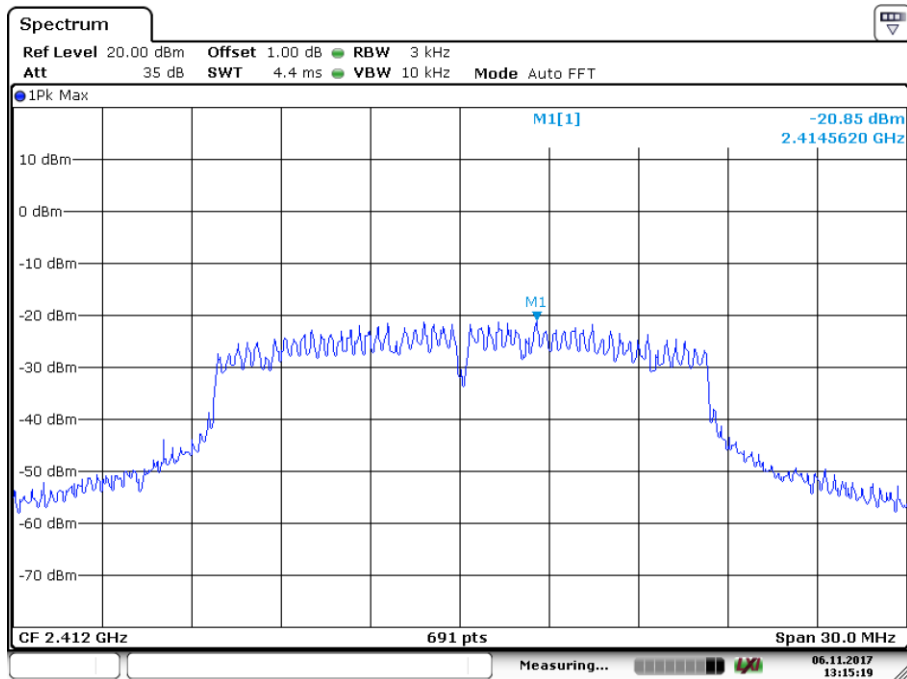

Date: 6. NOV. 2017 13:15:19

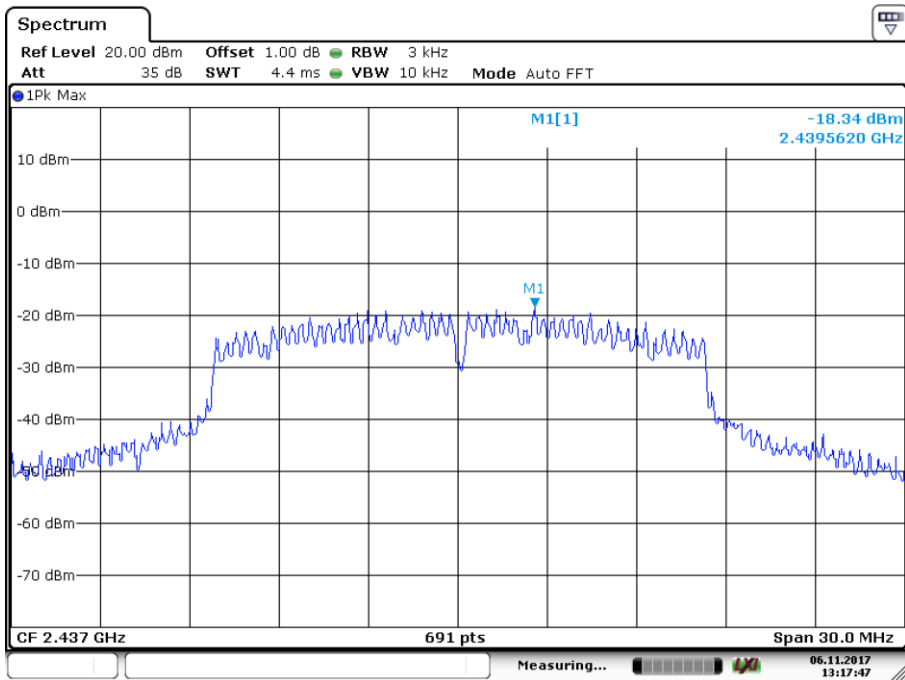

Date: 6.NOV.2017 13:17:47

2437MHz

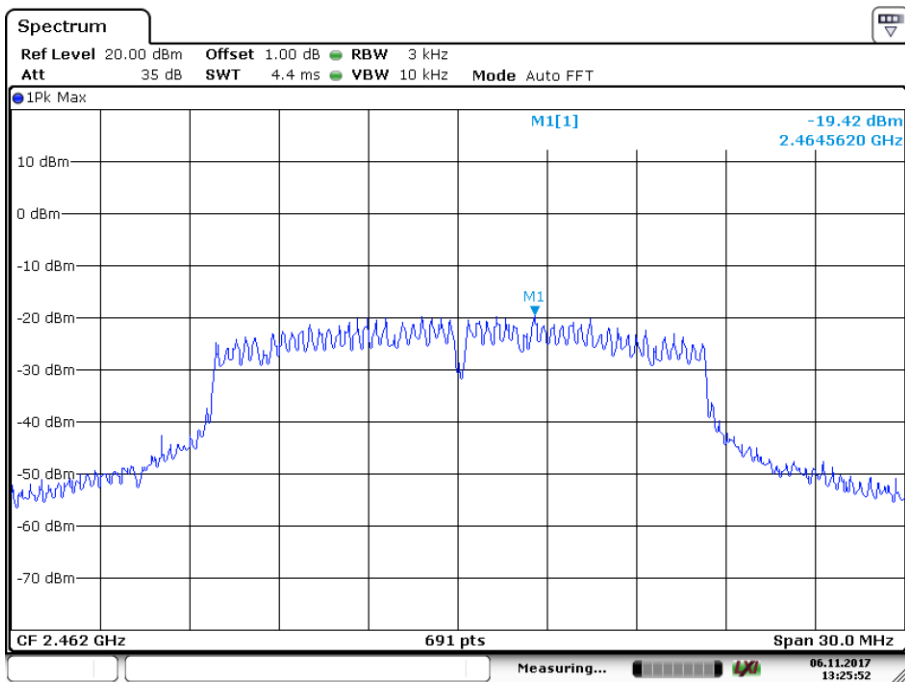

Date: 6.NOV.2017 13:25:53

2462MHz

802.11nHT20

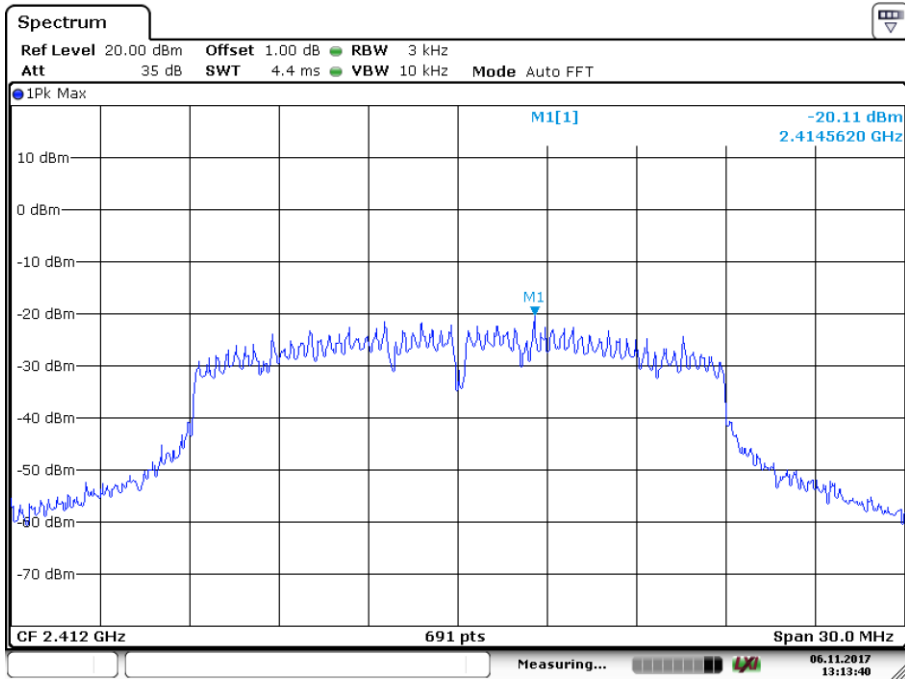

Date: 6.NOV.2017 13:13:40

2412MHz

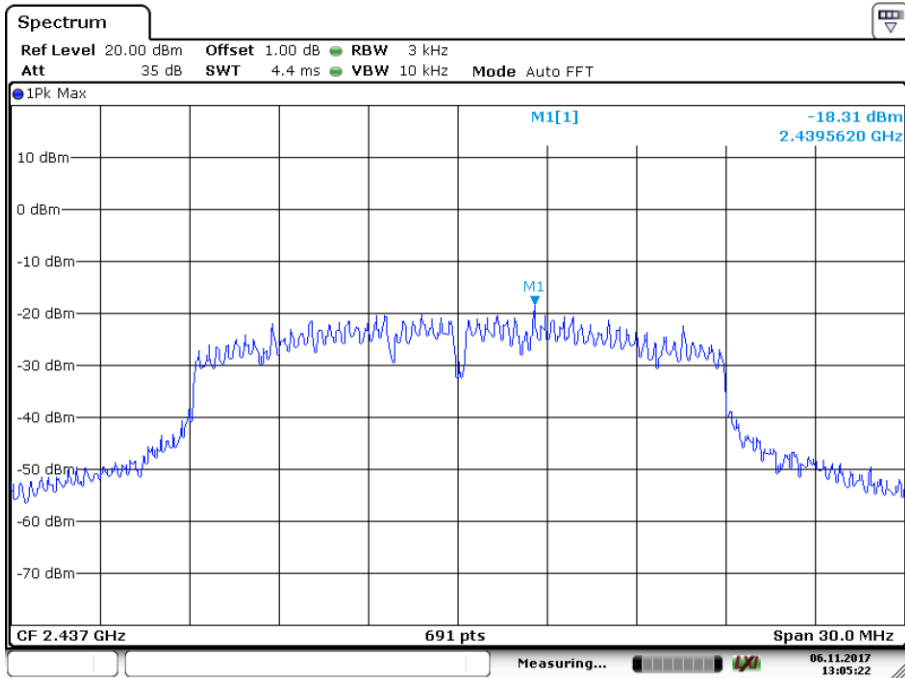

Date: 6.NOV.2017 13:05:22

2437MHz

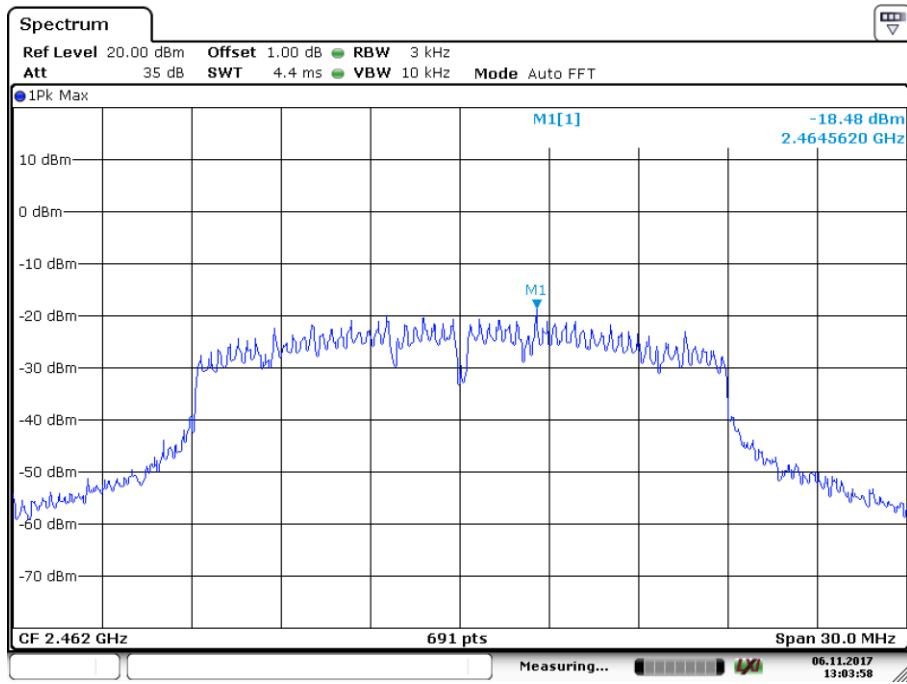

Date: 6. NOV. 2017 13:03:59

2462MHz

9.5 Spurious RF conducted emissions

Test Method

1. Establish a reference level by using the following procedure:
 - a. Set RBW=100 kHz. VBW \geq 3RBW. Detector =peak, Sweep time = auto couple, Trace mode = max hold.
 - b. Allow trace to fully stabilize, use the peak marker function to determine the maximum PSD level.
2. Use the maximum PSD level to establish the reference level.
 - a. Set the center frequency and span to encompass frequency range to be measured.
 - b. Use the peak marker function to determine the maximum amplitude level. Ensure that the amplitude of all unwanted emissions outside of the authorized frequency band (excluding restricted frequency bands) are attenuated by at least the minimum requirements, report the three highest emissions relative to the limit.
3. Repeat above procedures until other frequencies measured were completed.

Limit

Frequency Range MHz	Limit (dBc)
30-25000	-20

Spurious RF conducted emissions

802.11b

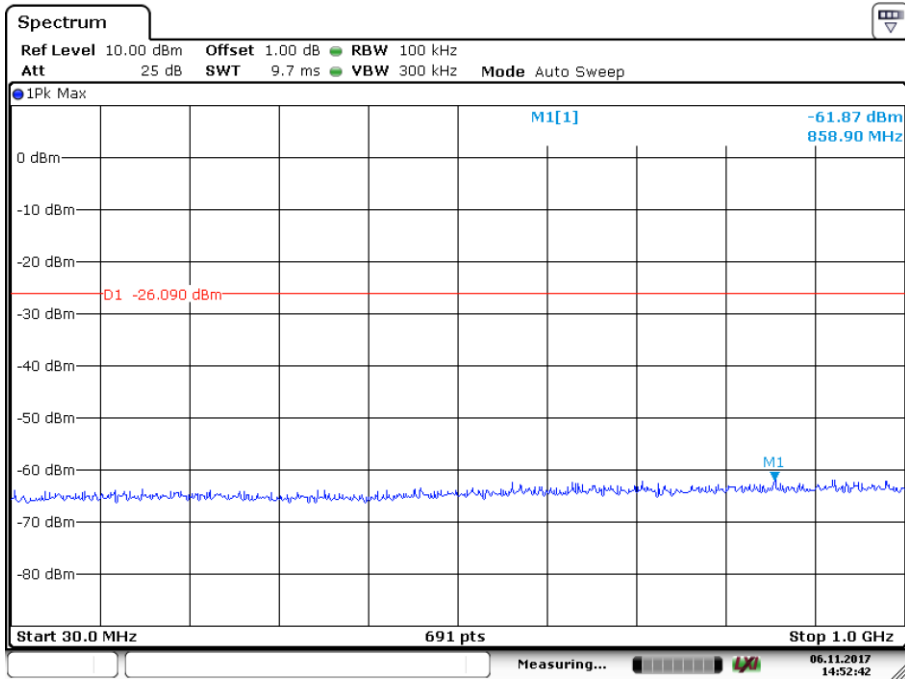

Date: 6.NOV.2017 14:52:43

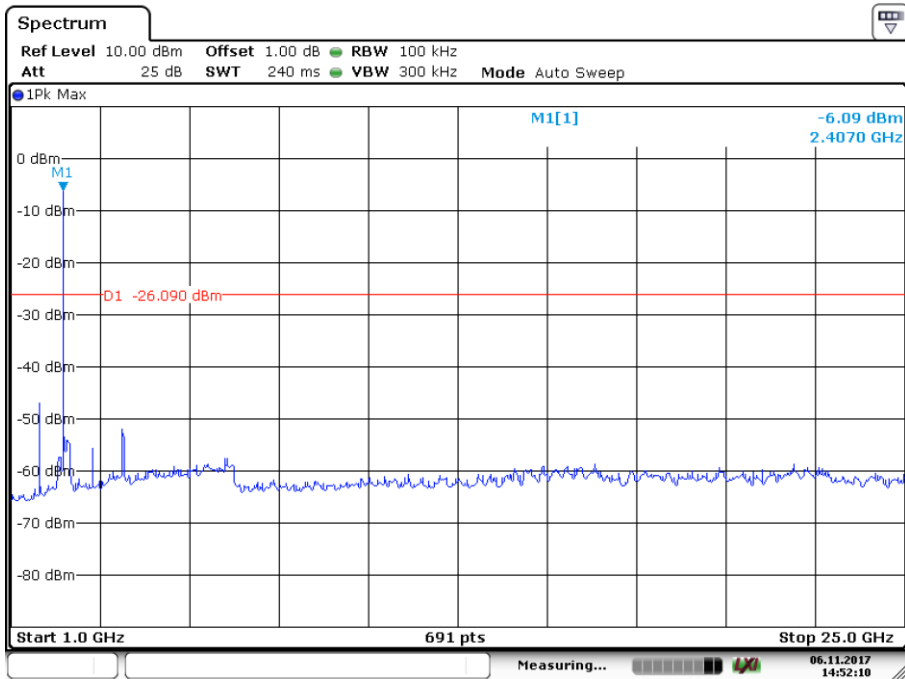

Date: 6.NOV.2017 14:52:10

2412MHz

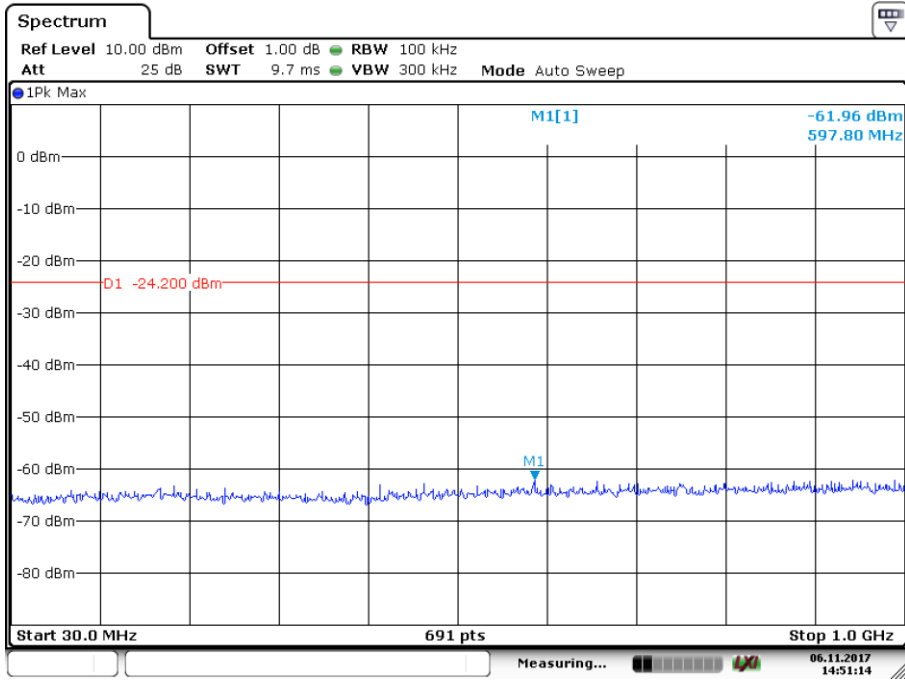

Date: 6.NOV.2017 14:51:15

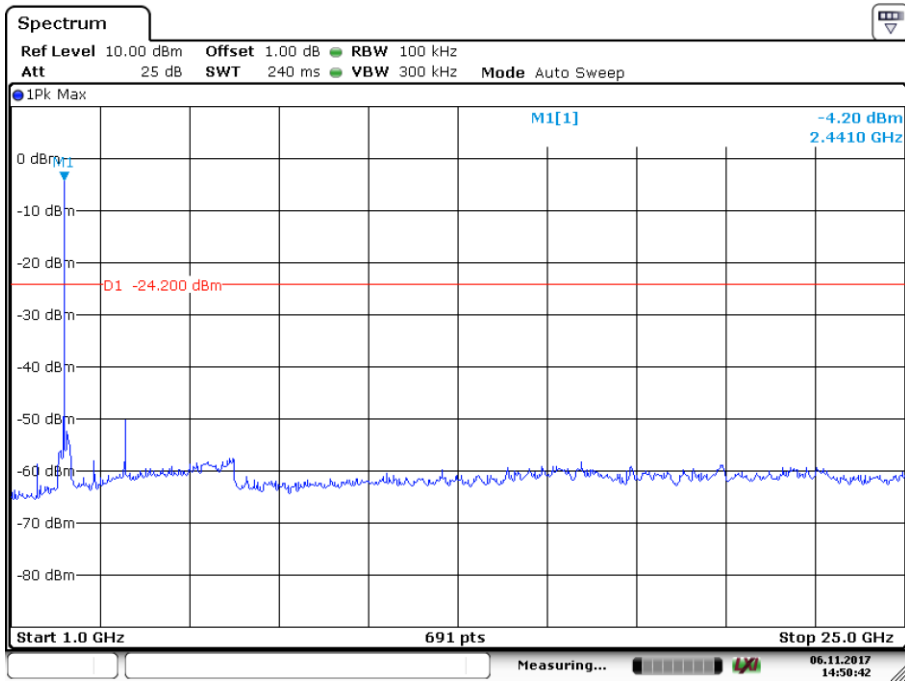

Date: 6.NOV.2017 14:50:42

2437MHz

Spurious RF conducted emissions

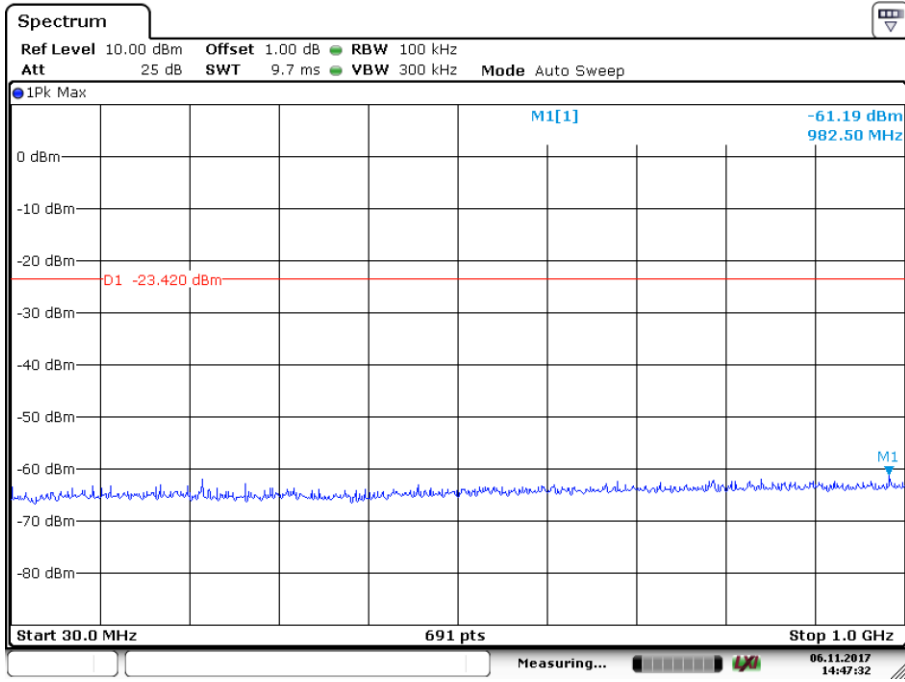

Date: 6 NOV. 2017 14:47:32

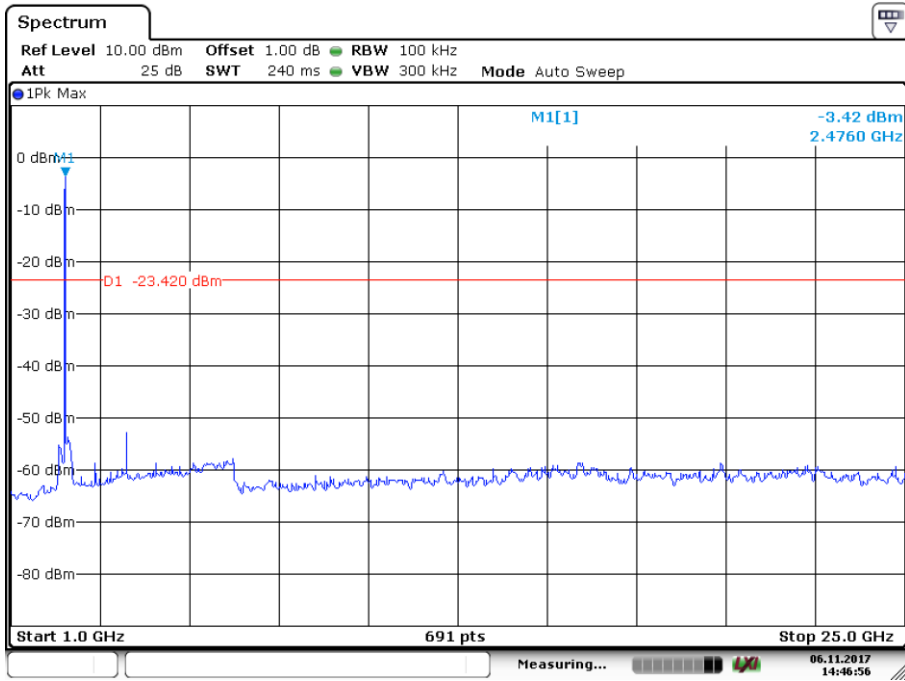

Date: 6 NOV. 2017 14:46:56

2462MHz

802.11g

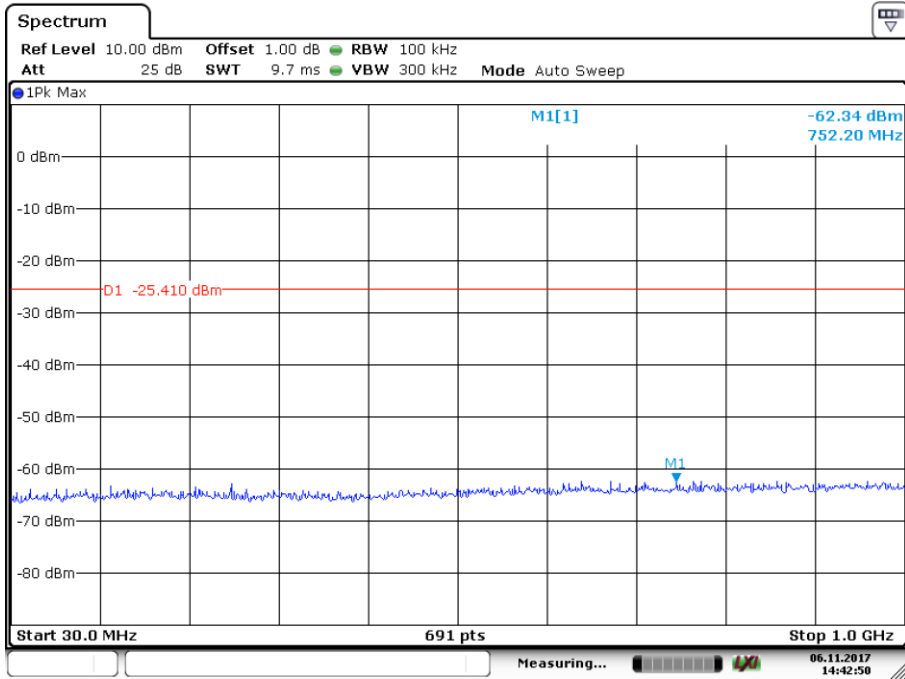

Date: 6 NOV. 2017 14:42:50

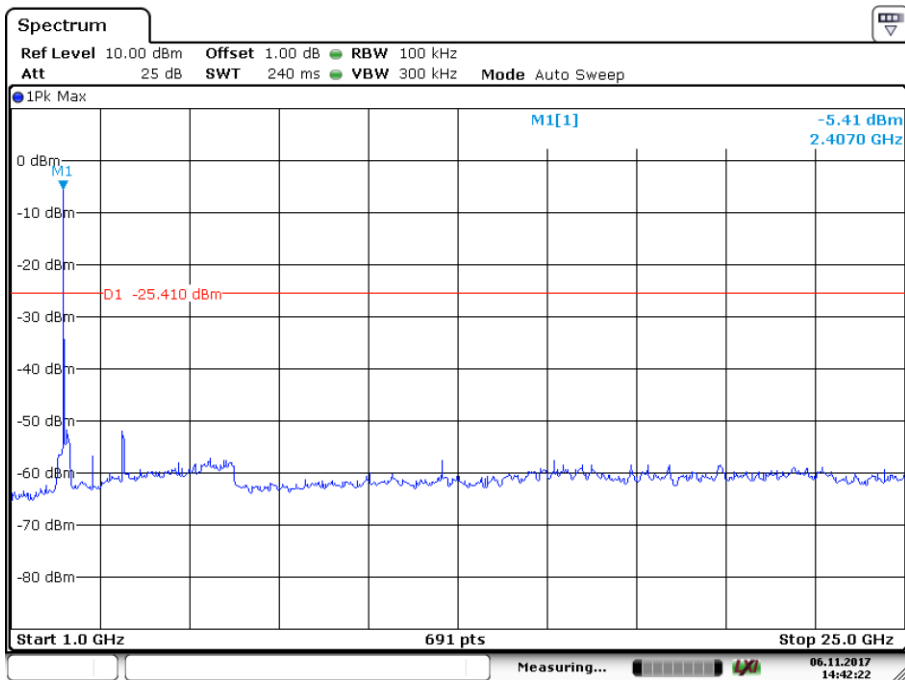

Date: 6 NOV. 2017 14:42:21

2412MHz

Spurious RF conducted emissions

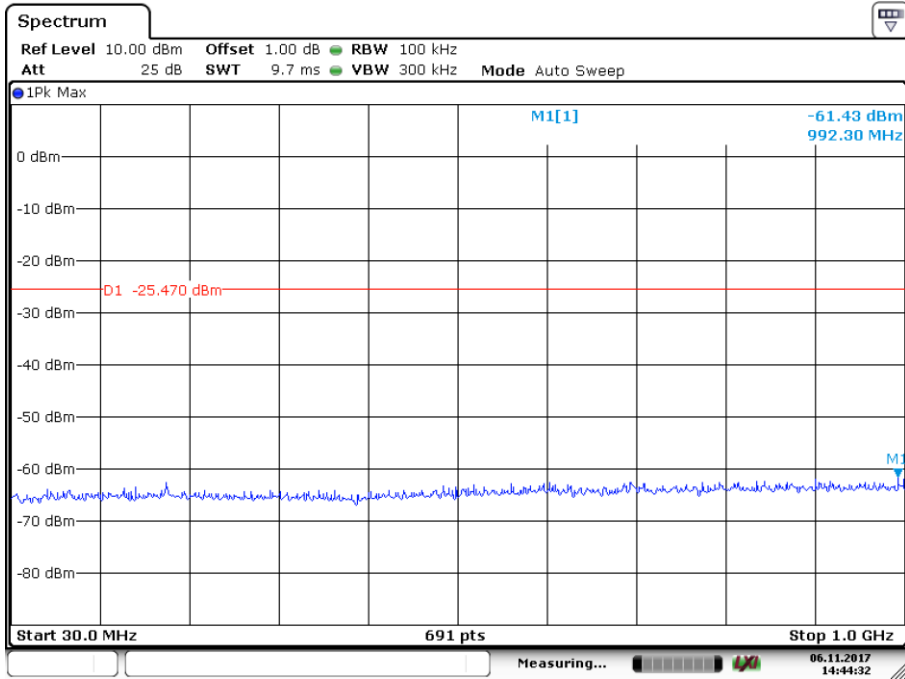

Date: 6 NOV.2017 14:44:32

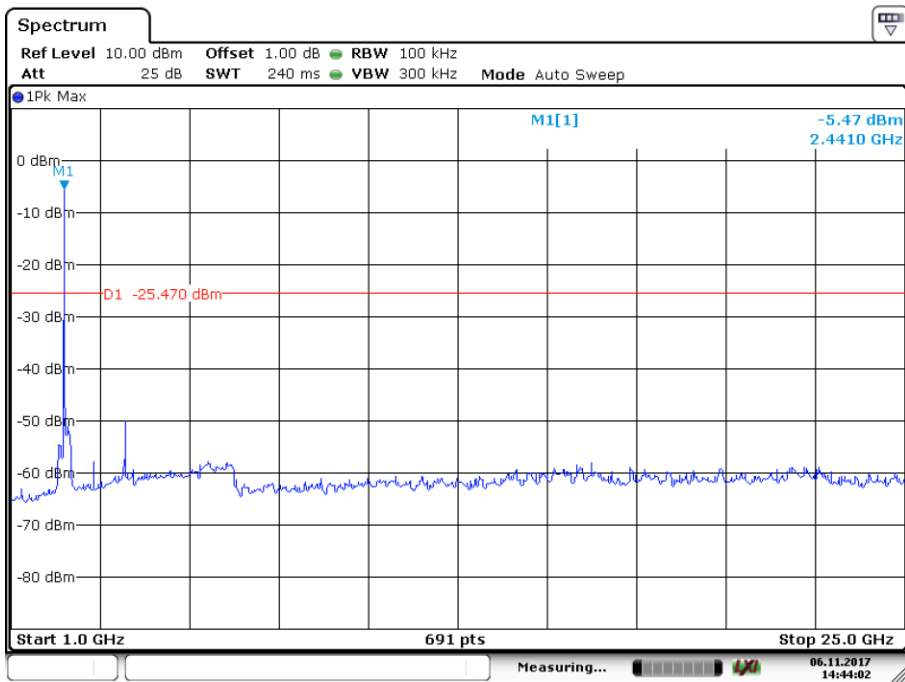

Date: 6 NOV.2017 14:44:03

2437MHz

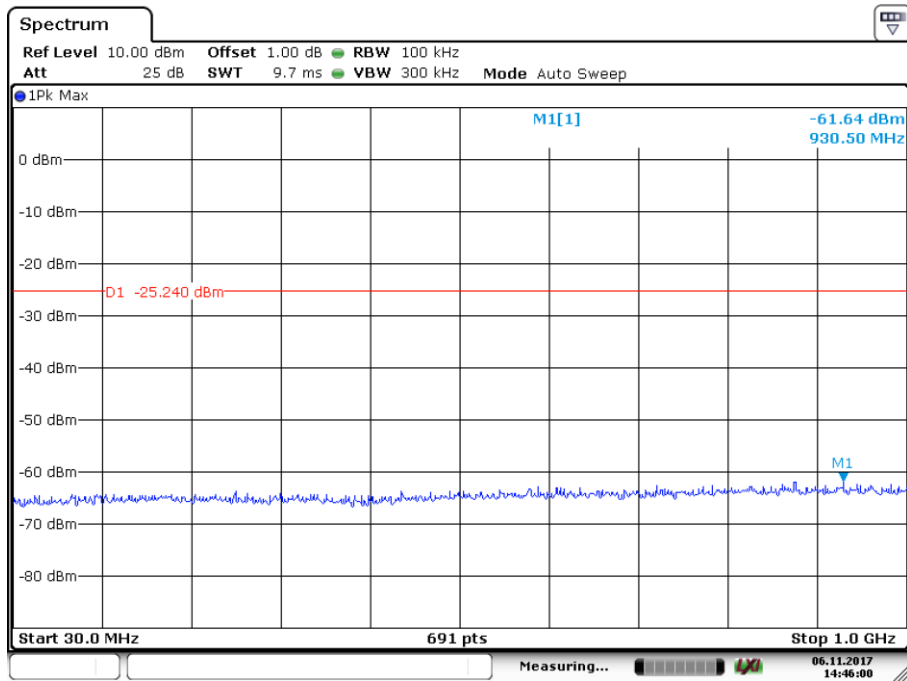

Date: 6. NOV. 2017 14:46:00

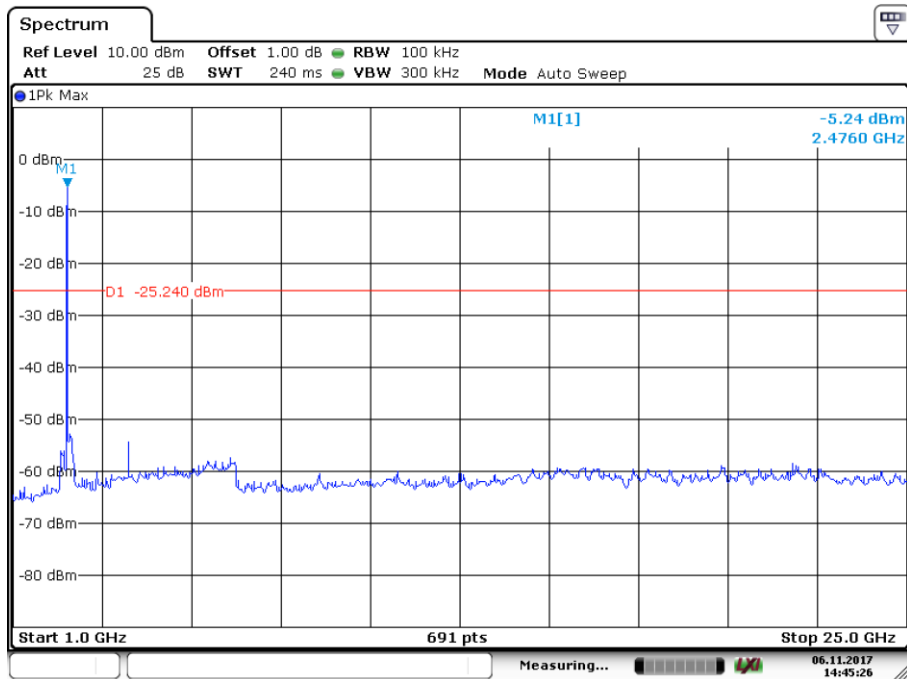

Date: 6. NOV. 2017 14:45:26

2462MHz

Spurious RF conducted emissions

802.11nHT20

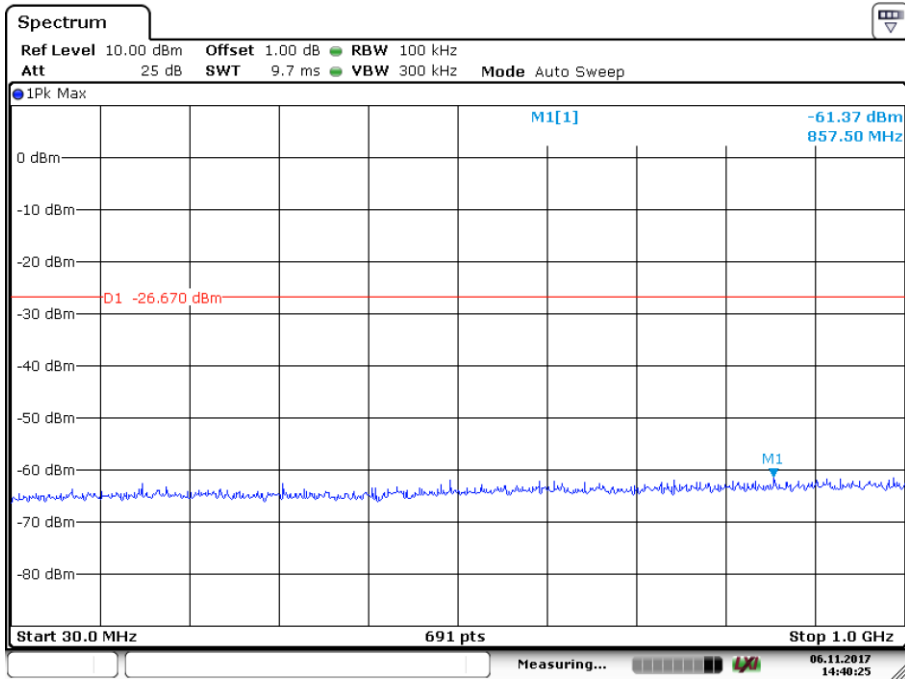

Date: 6.NOV.2017 14:40:25

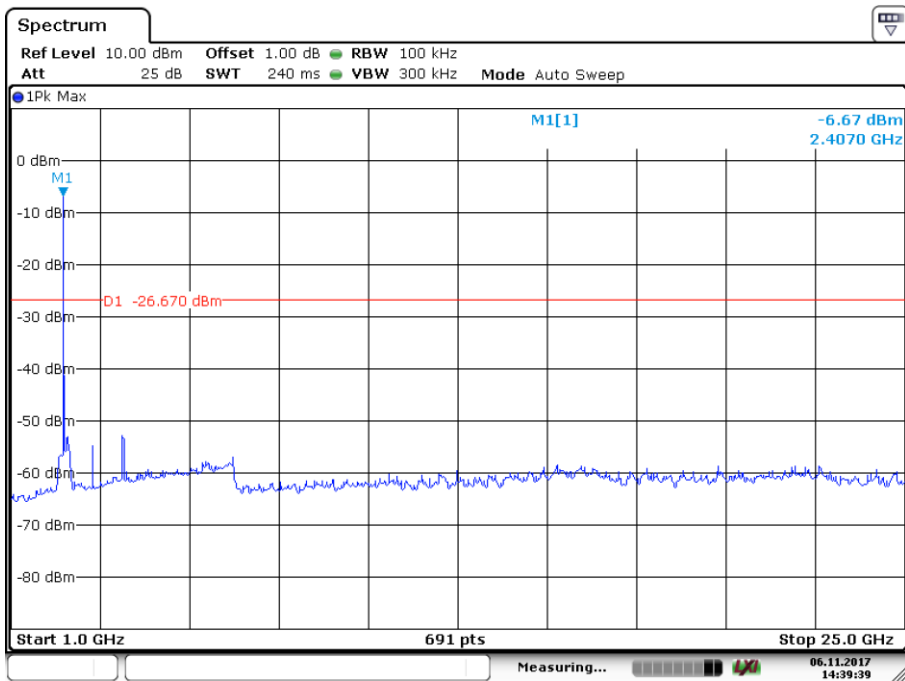

Date: 6.NOV.2017 14:39:39

2412MHz

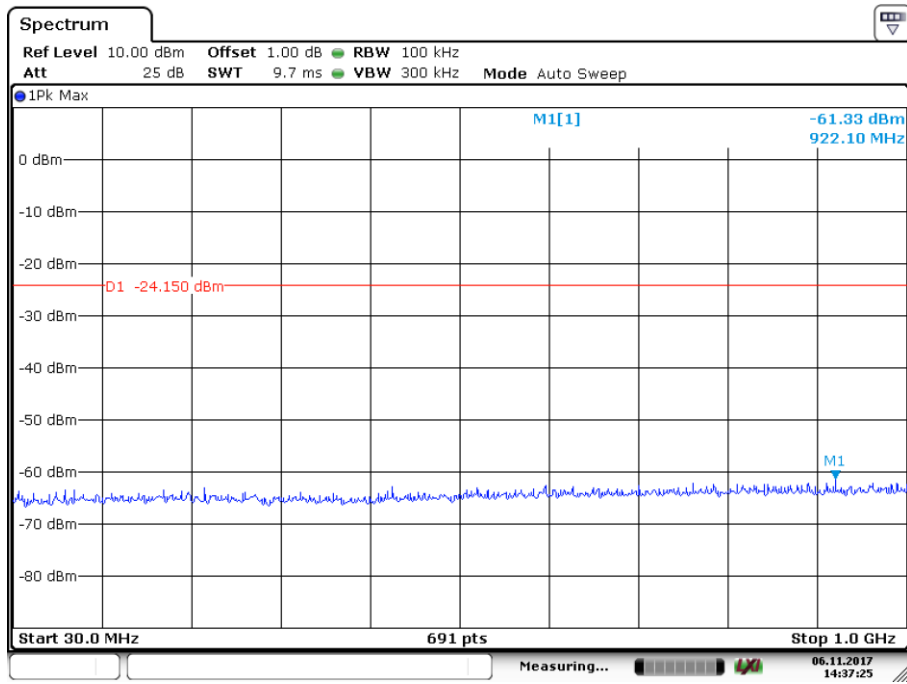

Date: 6.NOV.2017 14:37:25

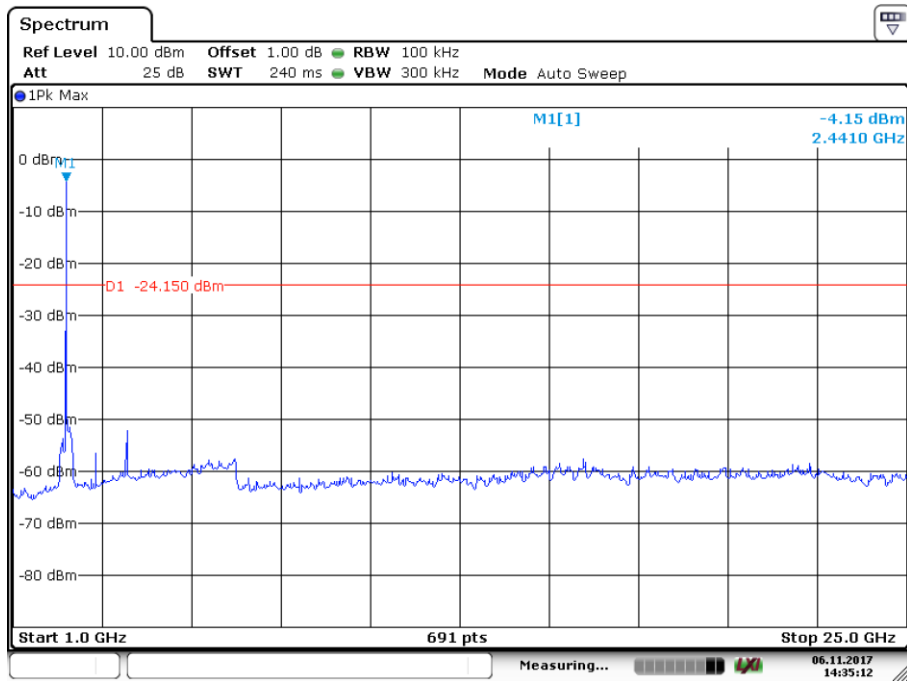

Date: 6.NOV.2017 14:35:12

2437MHz

Spurious RF conducted emissions

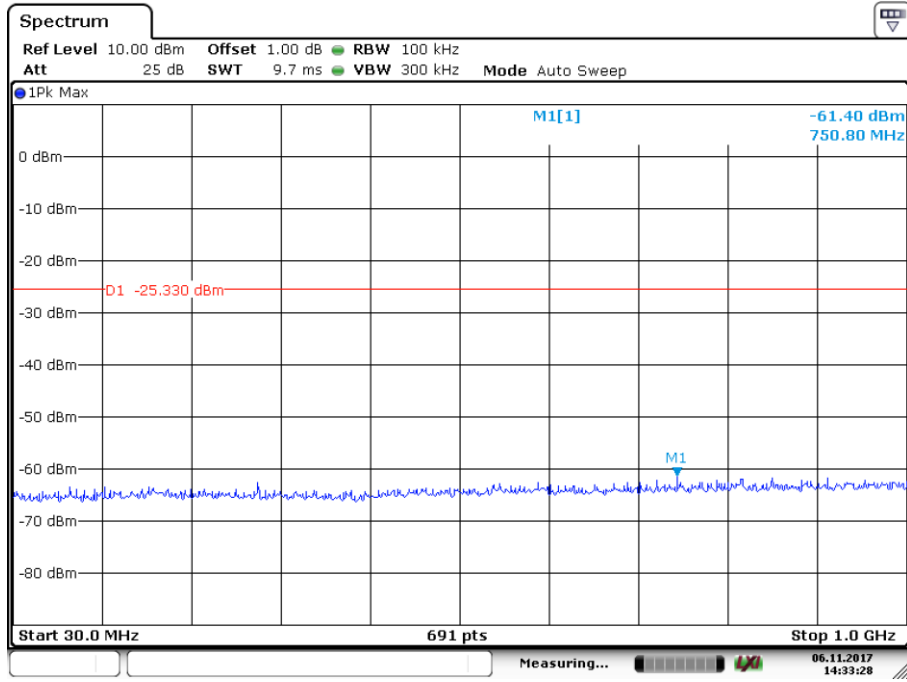

Date: 6 NOV. 2017 14:33:29

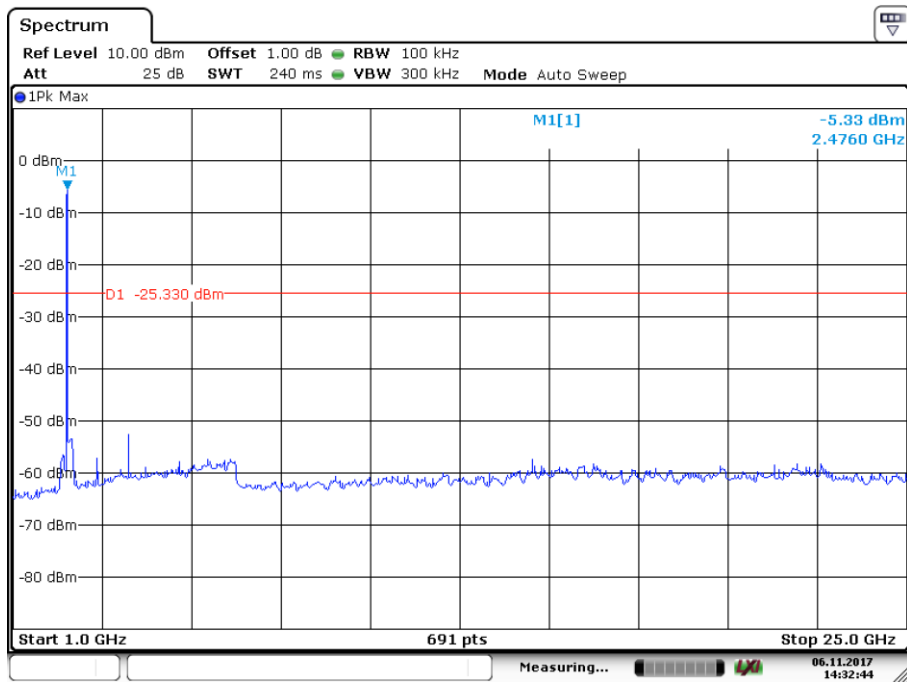

Date: 6 NOV. 2017 14:32:44

2462MHz

9.6 Band edge

Test Method

- 1 Use the following spectrum analyzer settings:
Span = wide enough to capture the peak level of the in-band emission and all spurious
RBW = 100 kHz, VBW \geq RBW, Sweep = auto, Detector function = peak, Trace = max hold.
- 2 Allow the trace to stabilize, use the peak and delta measurement to record the result.
- 3 The level displayed must comply with the limit specified in this Section.

Limit

Frequency Range MHz	Limit (dBc)
30-25000	-20

Test result

802.11b

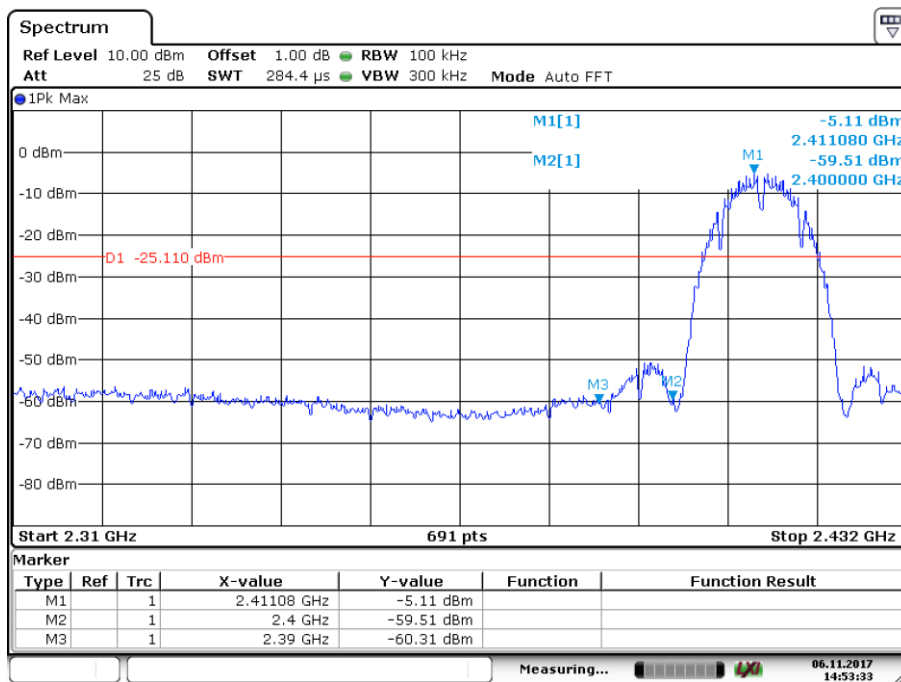

Date: 6.NOV.2017 14:53:33

2412MHz

Band edge

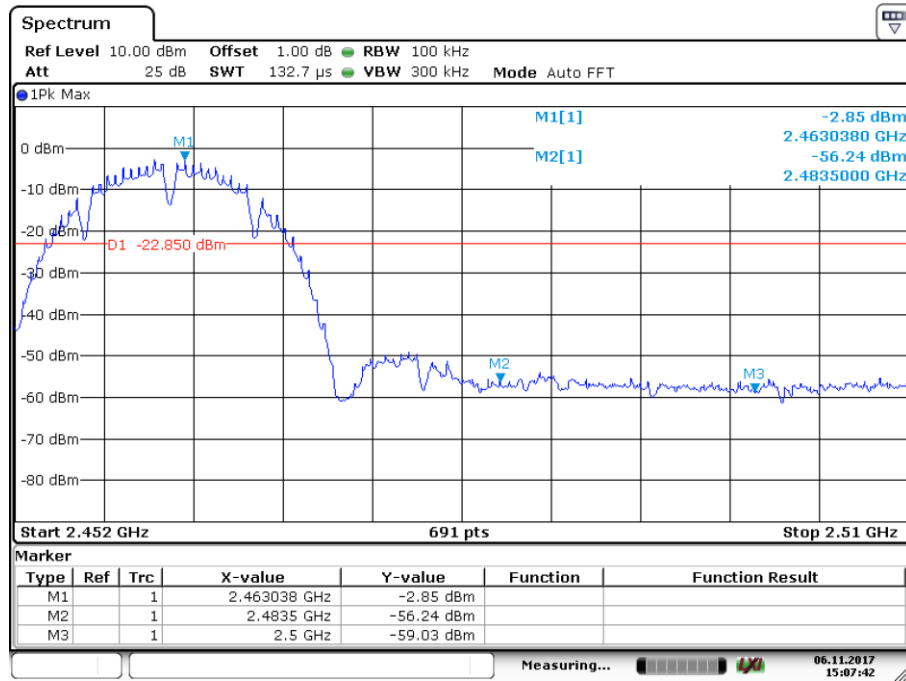

Date: 6.NOV.2017 15:07:42

2462MHz

802.11g

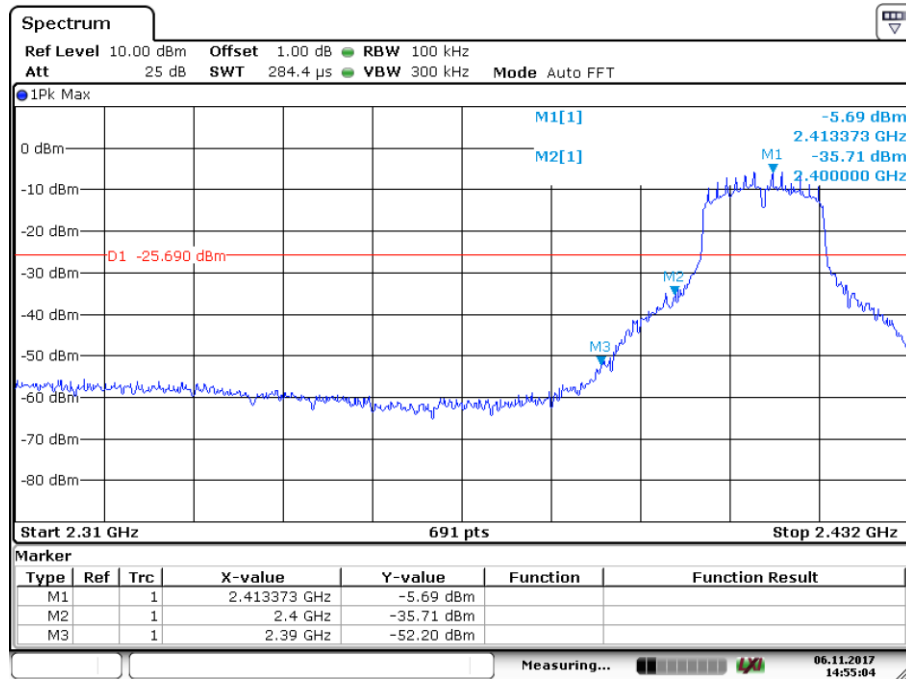

Date: 6.NOV.2017 14:55:05

2412MHz

Band edge

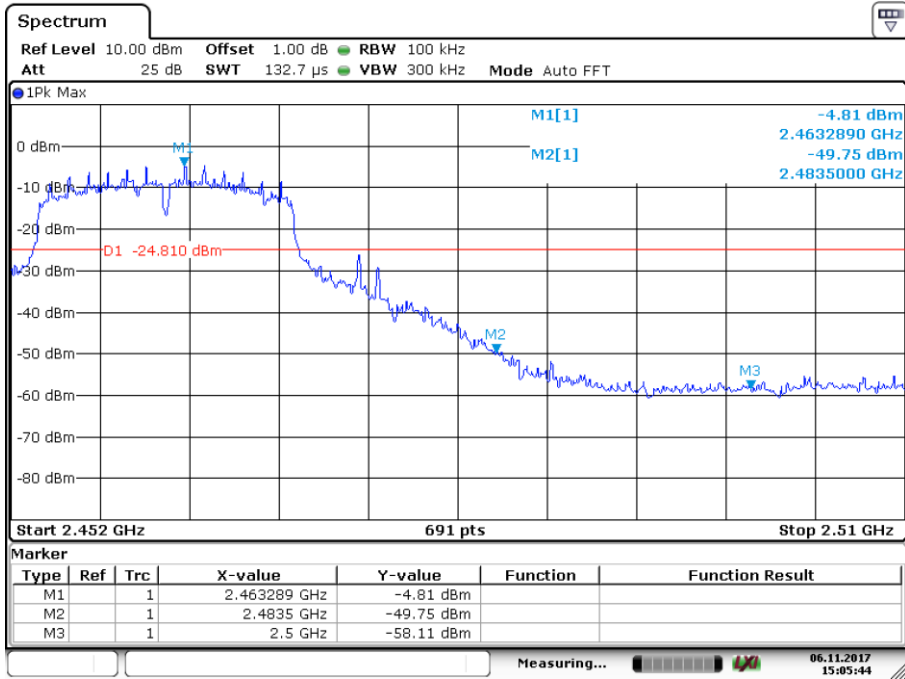

Date: 6 NOV. 2017 15:05:44

2462MHz

802.11nHT20

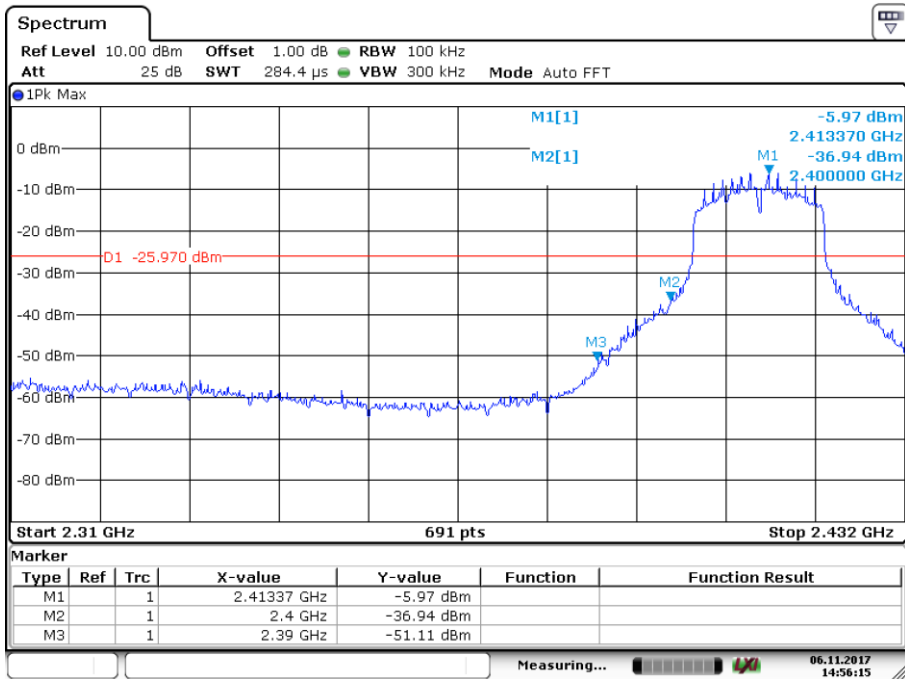

Date: 6 NOV. 2017 14:56:15

2412MHz

Band edge

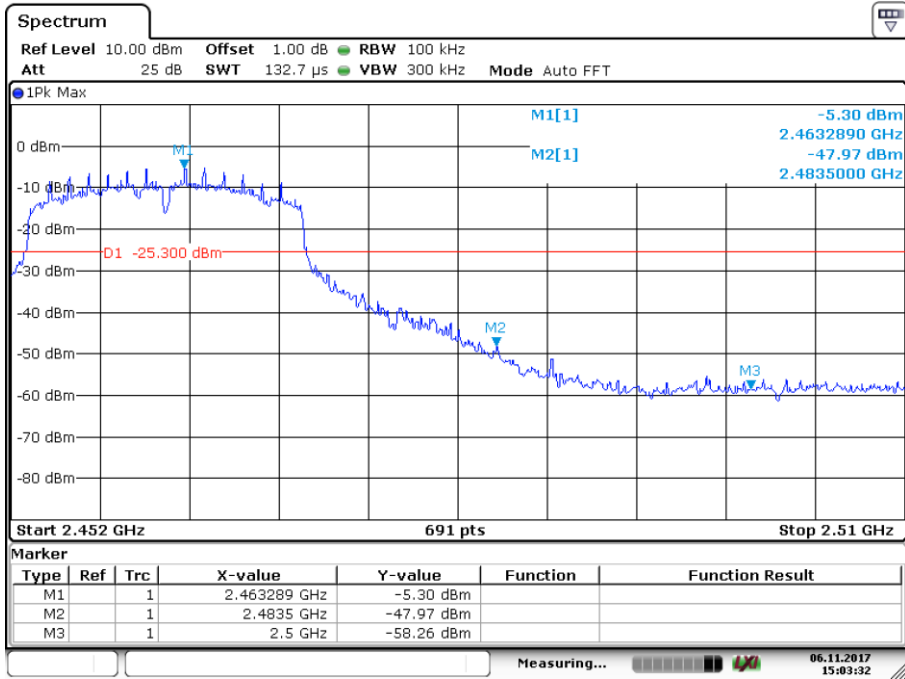

Date: 6 NOV.2017 15:03:32

2462MHz

9.7 Spurious radiated emissions for transmitter

Test Method

- 1: The EUT was placed on a turn table which is 1.5m above ground plane for above 1GHz and 0.8m above ground for below 1GHz at 3meter chamber room for test. The table was rotated 360 degrees to determine the position of the highest radiation.
- 2: The EUT was set 3 meters away from the interference – receiving antenna, which was mounted on the top of a variable – height antenna tower.
- 3: The height of antenna is varied from one meter to four meters above the ground to determine the maximum value of the field strength. Both horizontal and vertical polarizations of the antenna are set to make the measurement.
- 4: For each suspected emission, the EUT was arranged to its worst case and then the antenna was tuned to heights from 1 meter to 4 meters and the rotatable table was turned from 0 degrees to 360 degrees to find the maximum reading.
- 5: Use the following spectrum analyzer settings According to C63.10:
For Above 1GHz
Span = wide enough to capture the peak level of the in-band emission and all spurious
RBW = 1MHz, VBW \geq RBW for peak measurement and VBW = 10Hz for average measurement, Sweep = auto, Detector function = peak, Trace = max hold.

For Below 1GHz

Use the following spectrum analyzer settings:

Span = wide enough to capture the peak level of the in-band emission and all spurious
RBW = 100 KHz, VBW \geq RBW for peak measurement, Sweep = auto, Detector function = peak, Trace = max hold.

Note:

- 1: The resolution bandwidth and video bandwidth of test receiver/spectrum analyzer is 120 KHz for Quasi-peak detection (QP) at frequency below 1GHz.
- 2: The resolution bandwidth of test receiver/spectrum analyzer is 1MHz and the video bandwidth is 3MHz for peak detection (PK) at frequency above 1GHz.
- 3: The resolution bandwidth of test receiver/spectrum analyzer is 1MHz and the video bandwidth is 3MHz for RMS Average ((duty cycle < 98%) for Average detection (AV) at frequency above 1GHz, then the measurement results was added to a correction factor ($20\log(1/\text{duty cycle})$).
- 4: The resolution bandwidth of test receiver/spectrum analyzer is 1MHz and the video bandwidth is 10Hz (duty cycle > 98%) for Average detection (AV) at frequency above 1GHz.

Limit

The radio emission outside the operating frequency band shall be at least 20 dB below that in the 100 kHz bandwidth within the band that contains the highest level of the desired power. Radiated emissions which fall in the restricted bands, as defined in section 15.205, must comply with the radiated emission limits specified in section 15.209.

Frequency MHz	Field Strength uV/m	Field Strength dB μ V/m	Detector
30-88	100	40	QP
88-216	150	43.5	QP
216-960	200	46	QP
960-1000	500	54	QP
Above 1000	500	54	AV
Above 1000	5000	74	PK

Spurious radiated emissions for transmitter

According to C63.10, if the peak (or quasi-peak) measured value complies with the average limit, it is unnecessary to perform an average measurement, so AV emission value did not show in below table if the peak value complies with average limit.

Transmitting spurious emission test result as below:

802.11b

2412MHz (30MHz – 1GHz)

Frequency MHz	Emission Level dBuV/m	Polarization	Limit dBμV/m	Detector	Corr. dB/m	Result
31.45	22.00	Horizontal	40.00	QP	-26.2	Pass
32.10	32.77	Vertical	40.00	QP	-25.4	Pass

2412MHz (Above 1GHz)

Frequency MHz	Emission Level dBuV/m	Polarization	Limit dBμV/m	Detector	Corr. dB/m	Result
4018.12 *	43.63	Horizontal	74.00	PK	0.2	Pass
4018.59 *	48.34	Vertical	74.00	PK	0.4	Pass

Remark:

- (1) Data of measurement within this frequency range shown “-” in the table above means the reading of emissions are attenuated more than 20db below the permissible limits or the field strength is too small to be measured.
- (2) “*” means the emission(s) appear within the restrict bands shall follow the requirement of section 15.205.

2437MHz (30MHz – 1GHz)

Frequency	Emission Level	Polarization	Limit	Detector	Corr.	Result
MHz	dBuV/m		dBµV/m		dB/m	
--	--	Horizontal	--	QP	--	Pass
--	--	Vertical	--	QP	--	Pass

2437MHz (Above 1GHz)

Frequency	Emission Level	Polarization	Limit	Detector	Corr.	Result
MHz	dBuV/m		dBµV/m		dB/m	
4059.84 *	43.12	Horizontal	74.00	PK	0.1	Pass
4058.90 *	45.86	Vertical	74.00	PK	7.0	Pass

Remark:

- (1) Data of measurement within this frequency range shown “-” in the table above means the reading of emissions are attenuated more than 20db below the permissible limits or the field strength is too small to be measured.
- (2) “*” means the emission(s) appear within the restrict bands shall follow the requirement of section 15.205.

2462MHz (30MHz – 1GHz)

Frequency	Emission Level	Polarization	Limit	Detector	Corr.	Result
MHz	dBuV/m		dBµV/m		dB/m	
--	--	Horizontal	--	QP	--	Pass
--	--	Vertical	--	QP	--	Pass

2462MHz (Above 1GHz)

Frequency	Emission Level	Polarization	Limit	Detector	Corr.	Result
MHz	dBuV/m		dBµV/m		dB/m	
1584046 *	48.98	Horizontal	74.00	PK	19.4	Pass
4104.84 *	46.52	Vertical	74.00	PK	14.4	Pass

Remark:

- (1) Data of measurement within this frequency range shown “-” in the table above means the reading of emissions are attenuated more than 20db below the permissible limits or the field strength is too small to be measured.
- (2) “*” means the emission(s) appear within the restrict bands shall follow the requirement of section 15.205.

802.11g

2412MHz (30MHz – 1GHz)

Frequency MHz	Emission Level dBuV/m	Polarization	Limit dBµV/m	Detector	Corr. dB/m	Result
---	---	Horizontal	---	QP	---	Pass
---	---	Vertical	---	QP	---	Pass

2412MHz (Above 1GHz)

Frequency MHz	Emission Level dBuV/m	Polarization	Limit dBµV/m	Detector	Corr. dB/m	Result
14977.03 *	47.34	Horizontal	74.00	PK	18.6	Pass
14978.90 *	47.31	Vertical	74.00	PK	18.6	Pass

Remark:

- (1) Data of measurement within this frequency range shown “-” in the table above means the reading of emissions are attenuated more than 20db below the permissible limits or the field strength is too small to be measured.
- (2) “*” means the emission(s) appear within the restrict bands shall follow the requirement of section 15.205.

2437MHz (30MHz – 1GHz)

Frequency MHz	Emission Level dBuV/m	Polarization	Limit dBµV/m	Detector	Corr. dB/m	Result
--	--	Horizontal	--	QP	---	Pass
--	--	Vertical	--	QP	---	Pass

2437MHz (Above 1GHz)

Frequency MHz	Emission Level dBuV/m	Polarization	Limit dBµV/m	Detector	Corr. dB/m	Result
9099.37 *	41.09	Horizontal	74.00	PK	8.1	Pass
11807.34	43.63	Vertical	74.00	PK	12.1	Pass

Remark:

- (1) Data of measurement within this frequency range shown “-” in the table above means the reading of emissions are attenuated more than 20db below the permissible limits or the field strength is too small to be measured.
- (2) “*” means the emission(s) appear within the restrict bands shall follow the requirement of section 15.205.

2462MHz (30MHz – 1GHz)

Frequency MHz	Emission Level dBuV/m	Polarization	Limit dBμV/m	Detector	Corr. dB/m	Result
--	--	Horizontal	--	QP	---	Pass
--	--	Vertical	--	QP	---	Pass

2462MHz (Above 1GHz)

Frequency MHz	Emission Level dBuV/m	Polarization	Limit dBμV/m	Detector	Corr. dB/m	Result
15030.93 *	48.91	Horizontal	74.00	PK	18.7	Pass
10143.75 *	41.99	Vertical	74.00	PK	9.7	Pass

Remark:

- (1) Data of measurement within this frequency range shown “-” in the table above means the reading of emissions are attenuated more than 20db below the permissible limits or the field strength is too small to be measured.
- (2) “*” means the emission(s) appear within the restrict bands shall follow the requirement of section 15.205.

802.11nHT20

2412MHz (30MHz – 1GHz)

Frequency MHz	Emission Level dBuV/m	Polarization	Limit dBμV/m	Detector	Corr. dB/m	Result
--	--	Horizontal	--	QP	---	Pass
--	--	Vertical	--	QP	---	Pass

2412MHz (Above 1GHz)

Frequency MHz	Emission Level dBuV/m	Polarization	Limit dBμV/m	Detector	Corr. dB/m	Result
11746.40 *	43.89	Horizontal	74.00	PK	11.6	Pass
10685.15 *	42.10	Vertical	74.00	PK	10.1	Pass

Remark:

- (1) Data of measurement within this frequency range shown “-” in the table above means the reading of emissions are attenuated more than 20db below the permissible limits or the field strength is too small to be measured.
- (2) “*” means the emission(s) appear within the restrict bands shall follow the requirement of section 15.205.

2437MHz (30MHz – 1GHz)

Frequency	Emission Level	Polarization	Limit	Detector	Corr.	Result
MHz	dBuV/m		dB μ V/m		dB/m	
--	--	Horizontal	--	QP	---	Pass
--	--	Vertical	--	QP	---	Pass

2437MHz (Above 1GHz)

Frequency	Emission Level	Polarization	Limit	Detector	Corr.	Result
MHz	dBuV/m		dB μ V/m		dB/m	
12426.56 *	44.25	Horizontal	74.00	PK	12.8	Pass
16342.03 *	49.42	Vertical	74.00	PK	19.9	Pass

Remark:

- (1) Data of measurement within this frequency range shown "--" in the table above means the reading of emissions are attenuated more than 20db below the permissible limits or the field strength is too small to be measured.
- (2) "*" means the emission(s) appear within the restrict bands shall follow the requirement of section 15.205.

2462MHz (30MHz – 1GHz)

Frequency	Emission Level	Polarization	Limit	Detector	Corr.	Result
MHz	dBuV/m		dB μ V/m		dB/m	
--	--	Horizontal	--	QP	---	Pass
--	--	Vertical	--	QP	---	Pass

2462MHz (Above 1GHz)

Frequency	Emission Level	Polarization	Limit	Detector	Corr.	Result
MHz	dBuV/m		dB μ V/m		dB/m	
12814.21 *	42.32	Horizontal	74.00	PK	12.9	Pass
12038.43 *	42.44	Vertical	74.00	PK	11.8	Pass

Remark:

- (1) Data of measurement within this frequency range shown "--" in the table above means the reading of emissions are attenuated more than 20db below the permissible limits or the field strength is too small to be measured.
- (2) "*" means the emission(s) appear within the restrict bands shall follow the requirement of section 15.205.

10 Test Equipment List

List of Test Instruments

DESCRIPTION	MANUFACTURER	MODEL NO.	SERIAL NO.	CAL. DUE DATE
Signal Analyzer	Rohde & Schwarz	FSV40	101030	2018-7-14
EMI Test Receiver	Rohde & Schwarz	ESR 26	101269	2018-7-14
Trilog Super Broadband Test Antenna	Schwarzbeck	VULB 9163	707	2018-8-2
Horn Antenna	Rohde & Schwarz	HF907	102294	2018-7-14
Pre-amplifier	Rohde & Schwarz	SCU 18	102230	2018-7-14
3m Semi-anechoic chamber	TDK	9X6X6	----	2019-5-29
EMI Test Receiver	Rohde & Schwarz	ESR 26	101269	2018-7-14
Trilog Super Broadband Test Antenna	Schwarzbeck	VULB 9163	707	2018-8-2
Horn Antenna	Rohde & Schwarz	HF907	102294	2018-7-14
EMI Test Receiver	Rohde & Schwarz	ESR 3	101782	2018-7-14
LISN	Rohde & Schwarz	ENV4200	100249	2018-7-14
LISN	Rohde & Schwarz	ENV216	100326	2018-7-14
ISN	Rohde & Schwarz	ENY81	100177	2018-7-14
ISN	Rohde & Schwarz	ENY81-CA6	101664	2018-7-14
High Voltage Probe	Rohde & Schwarz	TK9420(VT94 20)	9420-58	2018-7-14
RF Current Probe	Rohde & Schwarz	EZ-17	100816	2018-7-14

Conducted RF tests

- Conducted peak output power
- 6dB bandwidth
- Power spectral density*
- Spurious RF conducted emissions
- Band edge

11 System Measurement Uncertainty

For a 95% confidence level, the measurement expanded uncertainties for defined systems, in accordance with the recommendations of ISO 17025 were:

System Measurement Uncertainty	
Test Items	Extended Uncertainty
Uncertainty for Radiated Spurious Emission 25MHz-3000MHz	Horizontal: 4.98dB; Vertical: 5.06dB;
Uncertainty for Radiated Spurious Emission 3000MHz-18000MHz	Horizontal: 4.95dB; Vertical: 4.94dB;
Uncertainty for Radiated Spurious Emission 18000MHz-40000MHz	Horizontal: 5.14dB; Vertical: 5.12dB;
Uncertainty for Conducted RF test with TS 8997	Power level test involved: 2.06dB Frequency test involved: 1.16×10^{-7}