

# SAR Test Report

Product Name : Mobile Phone  
Model No. : F1010  
FCC ID : 2AAZ8-F1010

Applicant : NEG TECHNOLOGY CO., LIMITED  
Address : Rm 1406, Block B, Jinsejari, Jingtian south road, Futian district, Shenzhen, China

Date of Receipt : Sep. 09, 2014  
Date of Test : Sep. 09, 2014  
Issued Date : Sep. 17, 2014  
Report No. : 1490255R-HP-US-P03V01  
Report Version : V1.0



The test results relate only to the samples tested.

The test report shall not be reproduced except in full without the written approval of QuieTek Corporation.

# Test Report Certification

Issued Date: Sep. 17, 2014

Report No.: 1490255R-HP-US-P03V01



Product Name : Mobile Phone  
 Applicant : NEG TECHNOLOGY CO., LIMITED  
 Address : Rm 1406, Block B, Jinsejiari, Jingtian south road, Futian district,  
 Shenzhen, China  
 Manufacturer : XINYUANTONG  
 Address : Rm 201, Yuetong B Building, Minzhi Road, Baoan District,  
 Shenzhen City  
 Model No. : F1010  
 EUT Voltage : DC 3.7V  
 Brand Name : OWN  
 FCC ID : 2AAZ8-F1010  
 Applicable Standard : IEEE Std. 1528-2013, 47CFR § 2.1093  
 FCC KDB Publication 447498 D01v05r02  
 FCC KDB Publication 648474 D04v01r02  
 FCC KDB Publication 865664 D01v01r03  
 FCC KDB Publication 941225 D01~D06  
 Test Result : Max. SAR Measurement (1g)  
 Head: 1.41 W/kg; Body-worn: 0.595 W/kg  
 Simultaneous Transmission: 1.577 W/kg  
 Performed Location : Suzhou EMC Laboratory  
 No.99 Hongye Rd., Suzhou Industrial Park Loufeng Hi-Tech  
 Development Zone., Suzhou, China  
 TEL: +86-512-6251-5088 / FAX: +86-512-6251-5098  
 FCC Registration Number: 800392

Documented By : Alice Ni  
 Reviewed By : Dream Cao  
 Approved By : Jeff Chen

## Laboratory Information

We, **QuieTek Corporation**, are an independent EMC and safety consultancy that was established the whole facility in our laboratories. The test facility has been accredited/accepted(audited or listed) by the following related bodies in compliance with ISO 17025, EN 45001 and specified testing scope:

<b>Taiwan R.O.C.</b>	<b>:</b>	<b>BSMI, NCC, TAF</b>
<b>Germany</b>	<b>:</b>	<b>TUV Rheinland</b>
<b>Norway</b>	<b>:</b>	<b>Nemko, DNV</b>
<b>USA</b>	<b>:</b>	<b>FCC</b>
<b>Japan</b>	<b>:</b>	<b>VCCI</b>
<b>China</b>	<b>:</b>	<b>CNAS</b>

The related certificate for our laboratories about the test site and management system can be downloaded from QuieTek Corporation's Web Site :<http://www.quietek.com/tw/ctg/cts/accreditations.htm>

The address and introduction of QuieTek Corporation's laboratories can be founded in our Web site :  
<http://www.quietek.com/>

If you have any comments, Please don't hesitate to contact us. Our contact information is as below:

### **HsinChu Testing Laboratory :**

No.75-2, 3rd Lin, Wangye Keng, Yonghxing Tsuen, Qionglin Shiang, Hsinchu County 307, Taiwan, R.O.C.  
TEL:+886-3-592-8858 / FAX:+886-3-592-8859                      E-Mail : [service@quietek.com](mailto:service@quietek.com)

### **LinKou Testing Laboratory :**

No.5-22, Ruishukeng, Linkou Dist., New Taipei City 24451, Taiwan, R.O.C.  
TEL : 886-2-8601-3788 / FAX : 886-2-8601-3789                      E-Mail : [service@quietek.com](mailto:service@quietek.com)

### **Suzhou Testing Laboratory :**

No.99 Hongye Rd., Suzhou Industrial Park Loufeng Hi-Tech Development Zone., SuZhou, China  
TEL : +86-512-6251-5088 / FAX : 86-512-6251-5098                      E-Mail : [service@quietek.com](mailto:service@quietek.com)

## TABLE OF CONTENTS

Description	Page
<b>1. General Information .....</b>	<b>7</b>
1.1. EUT Description .....	7
1.2. Test Environment.....	8
1.3. Simultaneous Transmission Configurations.....	9
1.4. SAR Test Exclusions Applied.....	10
1.5. Power Reduction for SAR.....	10
1.6. Guidance Documents .....	10
<b>2. SAR Measurement System .....</b>	<b>11</b>
2.1. DASY5 System Description.....	11
2.1.1. Applications .....	12
2.1.2. Area Scans .....	12
2.1.3. Zoom Scan (Cube Scan Averaging) .....	12
2.1.4. Uncertainty of Inter-/Extrapolation and Averaging .....	12
2.2. DASY5 E-Field Probe.....	13
2.2.1. Isotropic E-Field Probe Specification .....	13
2.3. Boundary Detection Unit and Probe Mounting Device .....	14
2.4. DATA Acquisition Electronics (DAE) and Measurement Server .....	14
2.5. Robot.....	15
2.6. Light Beam Unit.....	15
2.7. Device Holder.....	16
2.8. SAM Twin Phantom.....	16
<b>3. Tissue Simulating Liquid .....</b>	<b>17</b>
3.1. The composition of the tissue simulating liquid .....	17
3.2. Tissue Calibration Result.....	18
3.3. Tissue Dielectric Parameters for Head and Body Phantoms .....	19
<b>4. SAR Measurement Procedure .....</b>	<b>20</b>
4.1. SAR System Validation.....	20
4.1.1. Validation Dipoles .....	20
4.1.2. Validation Result .....	21
4.2. SAR Measurement Procedure.....	22
4.3. Body-Worn Accessory Configurations .....	23
<b>5. SAR Exposure Limits .....</b>	<b>24</b>

<b>6. Test Equipment List.....</b>	<b>25</b>
<b>7. Measurement Uncertainty.....</b>	<b>26</b>
<b>8. Conducted Power Measurement.....</b>	<b>27</b>
<b>9. Test Results.....</b>	<b>30</b>
9.1. SAR Test Results Summary .....	30
9.2. SAR Test Notes .....	34
<b>Appendix A. SAR System Validation Data .....</b>	<b>37</b>
<b>Appendix B. SAR measurement Data .....</b>	<b>41</b>
<b>Appendix C. Test Setup Photographs &amp; EUT Photographs.....</b>	<b>62</b>
<b>Appendix D. Probe Calibration Data .....</b>	<b>69</b>
<b>Appendix E. Dipole Calibration Data.....</b>	<b>80</b>
<b>Appendix F. DAE Calibration Data.....</b>	<b>104</b>

**History of This Test Report**

REPORT NO.	VERSION	DESCRIPTION	ISSUED DATE
1490255R-HP-US-P03V01	V1.0	Initial Issued Report	Sep. 17, 2014

## 1. General Information

### 1.1. EUT Description

Product Name	Mobile Phone
Model No.	F1010
IMEI	135790246811220
Device Category	Portable
RF Exposure Environment	Uncontrolled
Antenna Type	Internal
<b>2G</b>	
Support Band	GSM850/PCS1900
GPRS Class	Class 12
Uplink	GSM 850: 824~849MHz PCS 1900: 1850~1910MHz
Downlink	GSM 850: 869~894MHz PCS 1900: 1930~1990MHz
Release Version	R99
Type of modulation	GMSK for GSM/GPRS
Antenna Gain	GSM 850: 1.0dBi PCS1900: 1.0dBi
<b>Bluetooth</b>	
Bluetooth Frequency	2402~2480MHz
Bluetooth Version	V2.1
Type of modulation	GFSK
Data Rate	1Mbps(GFSK)
Antenna Gain	1.0dBi

**1.2. Test Environment**

Ambient conditions in the laboratory:

<b>Items</b>	<b>Required</b>	<b>Actual</b>
Temperature (°C)	18-25	21.5± 2
Humidity (%RH)	30-70	52



**1.3. Simultaneous Transmission Configurations**

According to FCC KDB Publication 447498 D01v05r02, transmitters are considered to be transmitting simultaneously when there is overlapping transmission, with the exception of transmissions during network hand-offs with maximum hand-off duration less than 30 seconds. This device contains multiple transmitters that may operate simultaneously, and therefore requires a simultaneously transmission analysis according to FCC KDB Publication 447498 D01v05r02 3) procedures.

Table 1-1  
Simultaneous Transmission Scenarios

Ref.	Simultaneous Transmit Configurations	Head	Body-Worn Accessory	Hotspot	Note
		IEEE1528 Supp C	FCC KDB447498 D01v05r02	FCC KDB941225 D06v01r01	
1	GSM850 Voice + BT	Yes	Yes	No	
2	PCS1900 Voice + BT	Yes	Yes	No	
3	GPRS850 Data+ BT	No	Yes	No	
4	GPRS1900 Data+ BT	No	Yes	No	

#### 1.4. SAR Test Exclusions Applied

(A) Bluetooth

Per FCC KDB 447498 D01v05R02, the SAR exclusion threshold for distances < 50mm is defined by the following equation:

$$\frac{\text{Max Power of Channel (mW)}}{\text{Test Separation Dist (mm)}} * \sqrt{\text{Frequency(GHz)}} \leq 3.0$$

Based on the maximum output power of Bluetooth and the antenna to use separation distance, Bluetooth SAR was not required;

[(3.98mW/5)\* √2.480]=1.25<3.0 for Head; [(3.98mW/10)\* √2.480]=0.626<3.0 for Body.

(B) Licensed Transmitter(s)

GSM/GPRS DTM is not supported for US bands. Therefore, the GSM Voice modes in this report do not transmit simultaneously with GPRS Data.

This device is only capable of QPSK HSPA in the uplink. Therefore, no additional SAR tests are required beyond that described for devices with HSPA in KDB 941225 D01v02.

#### 1.5. Power Reduction for SAR

There is no power reduction used for any band/mode implemented in this device for SAR purposes.

#### 1.6. Guidance Documents

- 1) FCC KDB Publication 941225 D01-D06 (2G, 3G and Hotspot)
- 2) FCC KDB Publication 447498 D01v05r02 (General SAR Guidance)
- 3) FCC KDB Publication 865664 D01v01r03 (SAR measurement 100 MHz to 6 GHz)
- 4) FCC KDB Publication 648474 D04v01r02 (SAR Evaluation Considerations for Wireless Handsets)

## 2. SAR Measurement System

### 2.1. DASY5 System Description

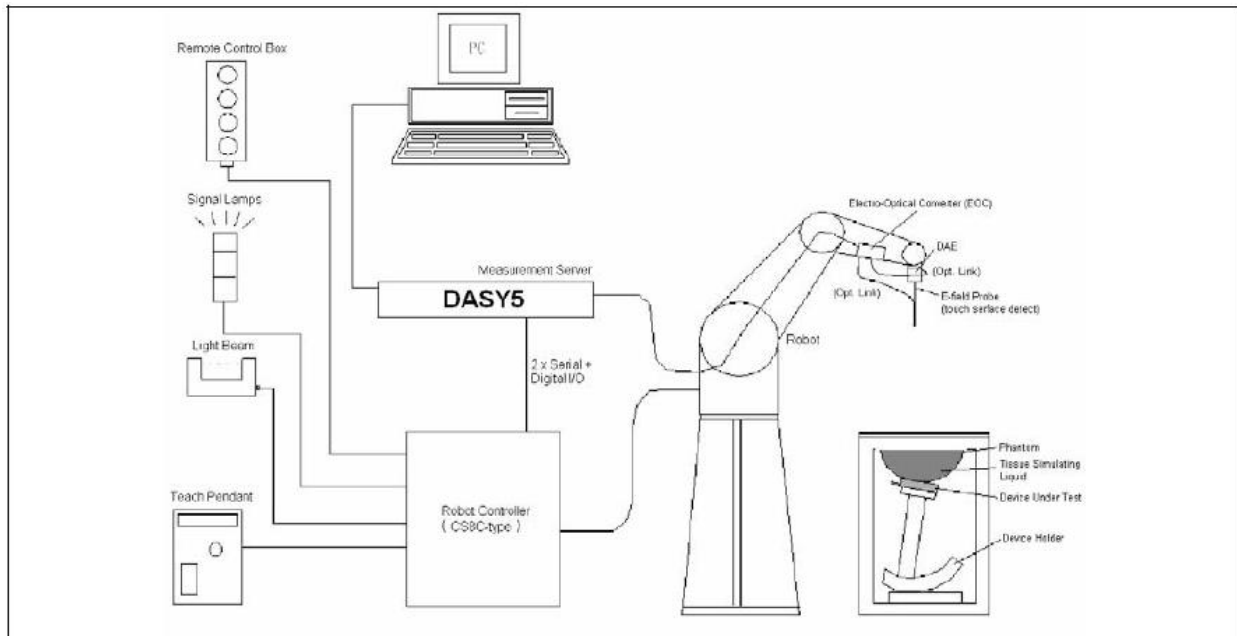

The DASY5 system for performing compliance tests consists of the following items:

- A standard high precision 6-axis robot with controller, teach pendant and software. An arm extension for accommodating the data acquisition electronics (DAE).
- A data acquisition electronics (DAE) which performs the signal amplification, signal multiplexing, AD-conversion, offset measurements, mechanical surface detection, collision detection, etc. The unit is battery powered with standard or rechargeable batteries. The signal is optically transmitted to the EOC.
- The Electro-optical converter (EOC) performs the conversion from optical to electrical signals for the digital communication to the DAE. To use optical surface detection, a special version of the EOC is required. The EOC signal is transmitted to the measurement server.
- The Light Beam used is for probe alignment. This improves the (absolute) accuracy of the probe positioning.
- A computer running WinXP and the DASY5 software.
- Remote control and teach pendant as well as additional circuitry for robot safety such as warning lamps, etc.
- The phantom, the device holder and other accessories according to the targeted measurement.

### **2.1.1. Applications**

Predefined procedures and evaluations for automated compliance testing with all worldwide standards, e.g., IEEE 1528, IEC 62209-1, IEC 62209-2, EN 50360, EN 50383 and others.

### **2.1.2. Area Scans**

Area scans are defined prior to the measurement process being executed with a user defined variable spacing between each measurement point (integral) allowing low uncertainty measurements to be conducted. Scans defined for FCC applications utilize a 10mm<sup>2</sup> step integral, with 1mm interpolation used to locate the peak SAR area used for zoom scan assessments.

When an Area Scan has measured all reachable points, it computes the field maxima found in the scanned area, within a range of the global maximum. The range (in dB) is specified in the standards for compliance testing. For example, a 2 dB range is required in IEEE 1528-2013 and IEC 62209 standards, whereby 3 dB is a requirement when compliance is assessed in accordance with the ARIB standard (Japan).

### **2.1.3. Zoom Scan (Cube Scan Averaging)**

Zoom Scans are used to assess the peak spatial SAR values within a cubic averaging volume containing 1 g and 10 g of simulated tissue. A density of 1000 kg/m<sup>3</sup> is used to represent the head and body tissue density and not the phantom liquid density, in order to be consistent with the definition of the liquid dielectric properties, i.e. the side length of the 1 g cube is 10mm, with the side length of the 10 g cube 21,5mm.

The zoom scan integer steps can be user defined so as to reduce uncertainty, but normal practice for typical test applications utilize a physical step of 7x7x7 (5mmx5mmx5mm) providing a volume of 30mm in the X & Y axis, and 30mm in the Z axis.

### **2.1.4. Uncertainty of Inter-/Extrapolation and Averaging**

In order to evaluate the uncertainty of the interpolation, extrapolation and averaged SAR calculation algorithms of the Postprocessor, DASY5 allows the generation of measurement grids which are artificially predefined by analytically based test functions. Therefore, the grids of area scans and zoom scans can be filled with uncertainty test data, according to the SAR benchmark functions of IEEE 1528. The three analytical functions shown in equations as below are used to describe the possible range of the expected SAR distributions for the tested handsets. The field gradients are covered by the spatially flat distribution f1, the spatially steep distribution f3 and f2 accounts for H-field cancellation on the phantom/tissue surface.

$$f_1(x, y, z) = Ae^{-\frac{z}{2a}} \cos^2 \left( \frac{\pi \sqrt{x'^2 + y'^2}}{2 \cdot 5a} \right)$$

$$f_2(x, y, z) = Ae^{-\frac{z}{a}} \frac{a^2}{a^2 + x'^2} \left( 3 - e^{-\frac{2z}{a}} \right) \cos^2 \left( \frac{\pi y'}{2 \cdot 3a} \right)$$

$$f_3(x, y, z) = A \frac{a^2}{\frac{a^2}{4} + x'^2 + y'^2} \left( e^{-\frac{2z}{a}} + \frac{a^2}{2(a + 2z)^2} \right)$$

**2.2. DASY5 E-Field Probe**

The SAR measurement is conducted with the dosimetric probe manufactured by SPEAG. The probe is specially designed and calibrated for use in liquid with high permittivity. The dosimetric probe has special calibration in liquid at different frequency. SPEAG conducts the probe calibration in compliance with international and national standards (e.g. IEEE 1528, EN 62209-1, IEC 62209, etc.) under ISO 17025. The calibration data are in Appendix D.

**2.2.1. Isotropic E-Field Probe Specification**

<b>Model</b>	EX3DV4	
<b>Construction</b>	Symmetrical design with triangular core Built-in shielding against static charges PEEK enclosure material (resistant to organic solvents, e.g., DGBE)	
<b>Frequency</b>	10 MHz to 6 GHz Linearity: ± 0.2 dB (30 MHz to 6 GHz)	
<b>Directivity</b>	± 0.3 dB in HSL (rotation around probe axis) ± 0.5 dB in tissue material (rotation normal to probe axis)	
<b>Dynamic Range</b>	10 µW/g to 100 mW/g Linearity: ± 0.2 dB (noise: typically < 1 µW/g)	
<b>Dimensions</b>	Overall length: 330 mm (Tip: 20 mm) Tip diameter: 2.5 mm (Body: 12 mm) Typical distance from probe tip to dipole centers: 1 mm	
<b>Application</b>	High precision dosimetric measurements in any exposure scenario (e.g., very strong gradient fields). Only probe which enables compliance testing for frequencies up to 6 GHz with precision of better 30%.	

**2.3. Boundary Detection Unit and Probe Mounting Device**

The DASY5 probes use a precise connector and an additional holder for the probe, consisting of a plastic tube and a flexible silicon ring to center the probe. The connector at the DAE is flexibly mounted and held in the default position with magnets and springs. Two switching systems in the connector mount detect frontal and lateral probe collisions and trigger the necessary software response.



**2.4. DATA Acquisition Electronics (DAE) and Measurement Server**

The data acquisition electronics (DAE) consists of a highly sensitive electrometer-grade preamplifier with auto-zeroing, a channel and gain-switching multiplexer, a fast 16 bit AD-converter and a command decoder and control logic unit.

Transmission to the measurement server is accomplished through an optical downlink for data and status information as well as an optical uplink for commands and the clock.

The input impedance of the DAE4 is 200M Ohm; the inputs are symmetrical and floating. Common mode rejection is above 80dB.



The DASY5 measurement server is based on a PC/104 CPU board with a 400MHz intel ULV Celeron, 128MB chipdisk and 128MB RAM. The necessary circuits for communication with the DAE electronics box, as well as the 16 bit AD converter system for optical detection and digital I/O interface are contained on the DASY5 I/O board, which is directly connected to the PC/104 bus of the CPU board.



**2.5. Robot**

The DASY5 system uses the high precision robots TX90 XL type out of the newer series from Stäubli SA (France). For the 6-axis controller DASY5 system, the CS8C robot controller version from Stäubli is used.

The XL robot series have many features that are important for our application:

- High precision (repeatability 0.02 mm)
- High reliability (industrial design)
- Jerk-free straight movements
- Low ELF interference (the closed metallic construction shields against motor control fields)
- 6-axis controller



**2.6. Light Beam Unit**

The light beam switch allows automatic "tooling" of the probe. During the process, the actual position of the probe tip with respect to the robot arm is measured, as well as the probe length and the horizontal probe offset. The software then corrects all movements, such that the robot coordinates are valid for the probe tip.

The repeatability of this process is better than 0.1 mm. If a position has been taught with an aligned probe, the same position will be reached with another aligned probe within 0.1 mm, even if the other probe has different dimensions. During probe rotations, the probe tip will keep its actual position.



## 2.7. Device Holder

The DASY5 device holder is designed to cope with different positions given in the standard. It has two scales for the device rotation (with respect to the body axis) and the device inclination (with respect to the line between the ear reference points). The rotation center for both scales is the ear reference point (EPR).

Thus the device needs no repositioning when changing the angles.

The DASY5 device holder has been made out of low-loss POM material having the following dielectric parameters: relative permittivity  $\epsilon_r = 3$  and loss tangent  $\delta = 0.02$ . The amount of dielectric material has been reduced in the closest vicinity of the device, since measurements have suggested that the influence of the clamp on the test results could thus be lowered.



## 2.8. SAM Twin Phantom

The SAM twin phantom is a fiberglass shell phantom with 2mm shell thickness (except the ear region where shell thickness increases to 6mm). It has three measurement areas:

- Left head
- Right head
- Flat phantom



The bottom plate contains three pair of bolts for locking the device holder. The device holder positions are adjusted to the standard measurement positions in the three sections. A white cover is provided to tap the phantom during off-periods to prevent water evaporation and changes in the liquid parameters. On the phantom top, three reference markers are provided to identify the phantom position with respect to the robot.



### 3. Tissue Simulating Liquid

#### 3.1. The composition of the tissue simulating liquid

INGREDIENT (% Weight)	835MHz Head	835MHz Body	1900MHz Head	1900MHz Body
<b>Water</b>	40.45	52.4	54.90	40.5
<b>Salt</b>	1.45	1.40	0.18	0.50
<b>Sugar</b>	57.6	45.0	0.00	58.0
<b>HEC</b>	0.40	1.00	0.00	0.50
<b>Preventol</b>	0.10	0.20	0.00	0.50
<b>DGBE</b>	0.00	0.00	44.92	0.00

**3.2. Tissue Calibration Result**

The dielectric parameters of the liquids were verified prior to the SAR evaluation using DASY5 Dielectric Probe Kit and Agilent Vector Network Analyzer E5071C

<b>Head Tissue Simulant Measurement</b>				
Frequency [MHz]	Description	Dielectric Parameters		Tissue Temp. [°C]
		$\epsilon_r$	$\sigma$ [s/m]	
835 MHz	Reference result ± 5% window	41.50 39.43 to 43.58	0.90 0.86 to 0.95	N/A
	09-09-2014	41.26	0.89	21.0
1900 MHz	Reference result ± 5% window	40.00 38.00 to 42.00	1.40 1.33 to 1.47	N/A
	09-09-2014	38.72	1.44	21.0

<b>Body Tissue Simulant Measurement</b>				
Frequency [MHz]	Description	Dielectric Parameters		Tissue Temp. [°C]
		$\epsilon_r$	$\sigma$ [s/m]	
835 MHz	Reference result ± 5% window	55.2 52.44 to 57.96	0.97 0.92 to 1.02	N/A
	09-09-2014	53.84	0.98	21.0
1900 MHz	Reference result ± 5% window	53.3 50.64 to 55.97	1.52 1.44 to 1.60	N/A
	09-09-2014	52.02	1.50	21.0

**3.3. Tissue Dielectric Parameters for Head and Body Phantoms**

The head tissue dielectric parameters recommended by the IEEE SCC-34/SC-2 in P1528 have been incorporated in the following table. These head parameters are derived from planar layer models simulating the highest expected SAR for the dielectric properties and tissue thickness variations in a human head. Other head and body tissue parameters that have not been specified in P1528 are derived from the tissue dielectric parameters computed from the 4-Cole-Cole equations described in Reference [12] and extrapolated according to the head parameters specified in P1528.

Target Frequency (MHz)	Head		Body	
	$\epsilon_r$	$\sigma$ (S/m)	$\epsilon_r$	$\sigma$ (S/m)
150	52.3	0.76	61.9	0.80
300	45.3	0.87	58.2	0.92
450	43.5	0.87	56.7	0.94
<b>835</b>	<b>41.5</b>	<b>0.90</b>	<b>55.2</b>	<b>0.97</b>
900	41.5	0.97	55.0	1.05
915	41.5	0.98	55.0	1.06
1450	40.5	1.20	54.0	1.30
1610	40.3	1.29	53.8	1.40
<b>1800 – 2000</b>	<b>40.0</b>	<b>1.40</b>	<b>53.3</b>	<b>1.52</b>
2450	39.2	1.80	52.7	1.95
3000	38.5	2.40	52.0	2.73
5800	35.3	5.27	48.2	6.00

( $\epsilon_r$  = relative permittivity,  $\sigma$  = conductivity and  $\rho = 1000 \text{ kg/m}^3$ )

## 4. SAR Measurement Procedure

### 4.1. SAR System Validation

#### 4.1.1. Validation Dipoles

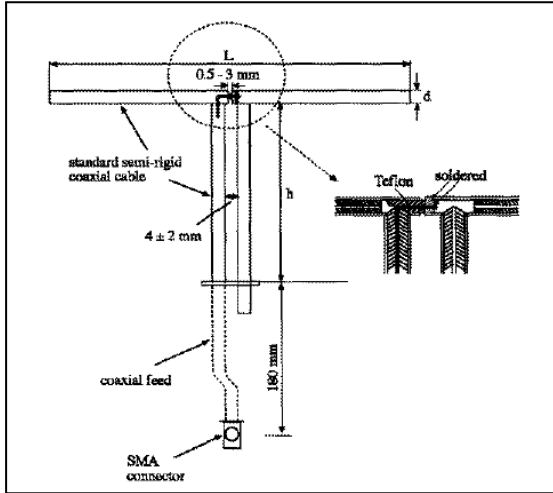

The dipoles used is based on the IEEE-1528 standard, and is complied with mechanical and electrical specifications in line with the requirements of both IEEE and FCC Supplement C. the table below provides details for the mechanical and electrical specifications for the dipoles.

Frequency	L (mm)	h (mm)	d (mm)
835MHz	161.0	89.8	3.6
1900MHz	68.0	39.5	3.6

**4.1.2. Validation Result**

<b>System Performance Check at 835MHz, 1900MHz for Head</b>				
<b>Validation Kit: D835V2-SN 4d094</b>				
Frequency [MHz]	Description	SAR [w/kg] 1g	SAR [w/kg] 10g	Tissue Temp. [°C]
835 MHz	Reference result ± 10% window	9.59 8.63 to 10.55	6.21 5.59 to 6.83	N/A
	09-09-2014	10.00	6.44	21.0
<b>Validation Kit: D1900V2-SN 5d121</b>				
Frequency [MHz]	Description	SAR [w/kg] 1g	SAR [w/kg] 10g	Tissue Temp. [°C]
1900 MHz	Reference result ± 10% window	41.1 36.99 to 45.21	21.3 19.17 to 23.43	N/A
	09-09-2014	39.04	19.88	21.0
Note: All SAR values are normalized to 1W forward power.				
<b>System Performance Check at 835MHz, 1900MHz for Body</b>				
<b>Validation Kit: D835V2-SN 4d094</b>				
Frequency [MHz]	Description	SAR [w/kg] 1g	SAR [w/kg] 10g	Tissue Temp. [°C]
835 MHz	Reference result ± 10% window	9.42 8.48 to 10.36	6.15 5.54 to 6.77	N/A
	09-09-2014	10.00	6.52	21.0
<b>Validation Kit: D1900V2-SN 5d121</b>				
Frequency [MHz]	Description	SAR [w/kg] 1g	SAR [w/kg] 10g	Tissue Temp. [°C]
1900 MHz	Reference result ± 10% window	39.7 35.73 to 43.67	20.9 18.81 to 22.99	N/A
	09-09-2014	41.60	21.48	21.0
Note: All SAR values are normalized to 1W forward power.				

#### 4.2. SAR Measurement Procedure

The DASYS calculates SAR using the following equation,

$$SAR = \frac{\sigma |E|^2}{\rho}$$

$\sigma$ : represents the simulated tissue conductivity

$\rho$ : represents the tissue density

The EUT is set to transmit at the required power in line with product specification, at each frequency relating to the LOW, MID, and HIGH channel settings.

Pre-scans are made on the device to establish the location for the transmitting antenna, using a large area scan in either air or tissue simulation fluid.

The EUT is placed against the Universal Phantom where the maximum area scan dimensions are larger than the physical size of the resonating antenna. When the scan size is not large enough to cover the peak SAR distribution, it is modified by either extending the area scan size in both the X and Y directions, or the device is shifted within the predefined area.

The area scan is then run to establish the peak SAR location (interpolated resolution set at 1mm<sup>2</sup> ) which is then used to orient the center of the zoom scan. The zoom scan is then executed and the 1g and 10g averages are derived from the zoom scan volume (interpolated resolution set at 1mm<sup>3</sup> ).

### 4.3. Body-Worn Accessory Configurations

Body-worn operating configurations are tested with the belt-clips and holsters attached to the device and positioned against a flat phantom in a normal use configuration. Per FCC KDB Publication 648474 D04 v01r02, Body-worn accessory exposure is typically related to voice mode operations when handsets are carried in body-worn accessories. The body-worn accessory procedures in FCC KDB Publication 447498 D01 v05r02 should be used to test for body-worn accessory SAR compliance, without a headset connected to it. This enables the test results for such configuration to be compatible with that required for hotspot mode when the body-worn accessory test separation distance is greater than or equal to that required for hotspot mode, when applicable. When the reported SAR for a body-worn accessory, measured without a headset connected to the handset, is  $> 1.2$  W/kg, the highest reported SAR configuration for that wireless mode and frequency band should be repeated for that body-worn accessory with a headset attached to the handset.

Accessories for Body-worn operation configurations are divided into two categories: those that do not contain metallic components and those that do contain metallic components. When multiple accessories that do not contain metallic components are supplied with the device, the device is tested with only the accessory that dictates the closest spacing to the body. Then multiple accessories that contain metallic components are tested with the device with each accessory. If multiple accessories share an identical metallic component (i.e. the same metallic belt-clip used with different holsters with no other metallic components) only the accessory that dictates the closest spacing to the body is tested.

Body-worn accessories may not always be supplied or available as options for some devices intended to be authorized for body-worn use. In this case, a test configuration with a separation distance between the back of the device and the flat phantom is used. Test position spacing was documented. Transmitters that are designed to operate in front of a person's face, as in push-to-talk configurations, are tested for SAR compliance with the front of the device positioned to face the flat phantom in head fluid. For devices that are carried next to the body such as a shoulder, waist or chest-worn transmitters, SAR compliance is tested with the accessories, including headsets and microphones, attached to the device and positioned against a flat phantom in a normal use configuration.

## 5. SAR Exposure Limits

SAR assessments have been made in line with the requirements of IEEE-1528, FCC Supplement C, and comply with ANSI/IEEE C95.1-1992 “Uncontrolled Environments” limits. These limits apply to a location which is deemed as “Uncontrolled Environment” which can be described as a situation where the general public may be exposed to an RF source with no prior knowledge or control over their exposure.

### Limits for General Population/Uncontrolled Exposure (W/kg)

Type Exposure	Uncontrolled Environment Limit
Spatial Peak SAR (1g cube tissue for brain or body)	1.60 W/kg
Spatial Average SAR (whole body)	0.08 W/kg
Spatial Peak SAR (10g for hands, feet, ankles and wrist)	4.00 W/kg



## 6. Test Equipment List

Instrument	Manufacturer	Model No.	Serial No.	Cali. Due Date
Stäubli Robot TX60L	Stäubli	TX60L	F10/5C90A1/A/01	N/A
Controller	Stäubli	SP1	S-0034	N/A
Dipole Validation Kits	Speag	D835V2	4d094	2016.02.26
Dipole Validation Kits	Speag	D1900V2	5d121	2016.02.26
SAM Twin Phantom	Speag	SAM	TP-1561/1562	N/A
Device Holder	Speag	SD 000 H01 HA	N/A	N/A
Data Acquisition Electronic	Speag	DAE4	1220	2015.01.21
E-Field Probe	Speag	EX3DV4	3710	2015.03.03
SAR Software	Speag	DASY5	V5.2 Build 162	N/A
Power Amplifier	Mini-Circuit	ZVA-183-S+	N657400950	N/A
Directional Coupler	Agilent	778D	20160	N/A
Universal Radio Communication Tester	R&S	CMU 200	117088	2015.03.28
Vector Network	Agilent	E5071C	MY48367267	2015.03.28
Signal Generator	Agilent	E4438C	MY49070163	2015.03.28
Power Meter	Anritsu	ML2495A	0905006	2014.11.01
Wide Bandwidth Sensor	Anritsu	MA2411B	0846014	2014.11.01

7. Measurement Uncertainty

DASY5 Uncertainty								
Measurement uncertainty for 300 MHz to 3 GHz averaged over 1 gram / 10 gram.								
Error Description	Uncert. value	Prob. Dist.	Div.	(ci) 1g	(ci) 10g	Std.Unc. (1g)	Std. nc. (10g)	(vi) $V_{eff}$
<b>Measurement System</b>								
Probe Calibration	±6.0%	N	1	1	1	±6.0%	±6.0%	∞
Axial Isotropy	±4.7%	R	$\sqrt{3}$	0.7	0.7	±1.9%	±1.9%	∞
Hemispherical Isotropy	±9.6%	R	$\sqrt{3}$	0.7	0.7	±3.9%	±3.9%	∞
Boundary Effects	±1.0%	R	$\sqrt{3}$	1	1	±0.6%	±0.6%	∞
Linearity	±4.7%	R	$\sqrt{3}$	1	1	±2.7%	±2.7%	∞
System Detection Limits	±1.0%	R	$\sqrt{3}$	1	1	±0.6%	±0.6%	∞
Readout Electronics	±0.3%	N	1	1	1	±0.3%	±0.3%	∞
Response Time	±0.8%	R	$\sqrt{3}$	1	1	±0.5%	±0.5%	∞
Integration Time	±2.6%	R	$\sqrt{3}$	1	1	±1.5%	±1.5%	∞
RF Ambient Noise	±3.0%	R	$\sqrt{3}$	1	1	±1.7%	±1.7%	∞
RF Ambient Reflections	±3.0%	R	$\sqrt{3}$	1	1	±1.7%	±1.7%	∞
Probe Positioner	±0.4%	R	$\sqrt{3}$	1	1	±0.2%	±0.2%	∞
Probe Positioning	±2.9%	R	$\sqrt{3}$	1	1	±1.7%	±1.7%	∞
Max. SAR Eval.	±1.0%	R	$\sqrt{3}$	1	1	±0.6%	±0.6%	∞
<b>Test Sample Related</b>								
Device Positioning	±2.9%	N	1	1	1	±2.9%	±2.9%	145
Device Holder	±3.6%	N	1	1	1	±3.6%	±3.6%	5
Power Drift	±5.0%	R	$\sqrt{3}$	1	1	±2.9%	±2.9%	∞
<b>Phantom and Setup</b>								
Phantom Uncertainty	±4.0%	R	$\sqrt{3}$	1	1	±2.3%	±2.3%	∞
Liquid Conductivity (target)	±5.0%	R	$\sqrt{3}$	0.64	0.43	±1.8%	±1.2%	∞
Liquid Conductivity (meas.)	±2.5%	N	1	0.64	0.43	±1.6%	±1.1%	∞
Liquid Permittivity (target)	±5.0%	R	$\sqrt{3}$	0.6	0.49	±1.7%	±1.4%	∞
Liquid Permittivity (meas.)	±2.5%	N	1	0.6	0.49	±1.5%	±1.2%	∞
<b>Combined Std. Uncertainty</b>						±11.0%	±10.8%	387
<b>Expanded STD Uncertainty</b>						±22.0%	±21.5%	

## 8. Conducted Power Measurement

Mode	Frequency (MHz)	Avg. Burst Power (dBm)	Duty Cycle Factor (dB)	Frame Power (dBm)	Max. Power (dBm)	Scaling Factor
Max. Power						
GSM850	824.2	32.43	-9	23.43	33.0	1.140
	836.4	32.58	-9	23.58	33.0	1.102
	848.8	32.74	-9	23.74	33.0	1.062
GPRS850-1slot	824.2	32.35	-9	23.35	33.0	1.161
	836.4	32.52	-9	23.52	33.0	1.117
	848.8	32.67	-9	23.67	33.0	1.079
GPRS850-2slot	824.2	31.22	-6	25.22	32.0	1.197
	836.4	31.46	-6	25.46	32.0	1.132
	848.8	31.72	-6	25.72	32.0	1.067
GPRS850-3slot	824.2	29.22	-4.25	24.97	30.0	1.197
	836.4	29.43	-4.25	25.18	30.0	1.140
	848.8	29.67	-4.25	25.42	30.0	1.079
GPRS850-4slot	824.2	28.20	-3	25.20	29.0	1.202
	836.4	28.49	-3	25.49	29.0	1.125
	848.8	28.77	-3	25.77	29.0	1.054
PCS1900	1850.2	26.99	-9	17.99	27.0	1.002
	1880.0	26.56	-9	17.56	27.0	1.107
	1909.8	26.31	-9	17.31	27.0	1.172
GPRS1900-1slot	1850.2	26.95	-9	17.95	27.0	1.012
	1880.0	26.33	-9	17.33	27.0	1.167
	1909.8	25.87	-9	16.87	27.0	1.297
GPRS1900-2slot	1850.2	25.62	-6	19.62	26.0	1.091
	1880.0	25.03	-6	19.03	26.0	1.250
	1909.8	24.63	-6	18.63	26.0	1.371
GPRS1900-3slot	1850.2	23.16	-4.25	18.91	23.5	1.081
	1880.0	22.49	-4.25	18.24	23.5	1.262
	1909.8	22.06	-4.25	17.81	23.5	1.393
GPRS1900-4slot	1850.2	22.03	-3	19.03	22.5	1.114
	1880.0	21.39	-3	18.39	22.5	1.291
	1909.8	21.05	-3	18.05	22.5	1.396

Note 1: Scaling Factor = Max. Power(mW) / Avg. Burst Power(mW)

2: This device operates using the following maximum and nominal output power specifications. SAR values were scaled to the maximum allowed power to determine compliance per KDB Publication

447498 D01v05r02.

3: Both burst-averaged and calculated frame-averaged powers are included. Frame-averaged powers were calculated from the measured burst-averaged power by converting the slot powers into linear units and calculating the energy over 8 timeslots.

4: The bolded GPRS modes were selected for SAR testing according to the highest frame-averaged output power table per KDB 941225 D03v01.

5: GPRS(GMSK) output powers were measured with coding scheme setting of 1 (CS1) on the base station simulator. CS1 was configured to measure GPRS output power measurements and SAR to ensure GMSK modulation in the signal. Our Investigation has shown that CS1 - CS4 settings do not have any impact on the output levels or modulation in the GPRS modes.

**BT output power**

Test Mode	Channel No.	Frequency (MHz)	Average Power (dBm)	Max. Power (dBm)
DH5	01	2402	5.11	6.0
	40	2441	5.57	6.0
	79	2480	5.84	6.0

## 9. Test Results

### 9.1. SAR Test Results Summary

SAR MEASUREMENT									
Ambient Temperature (°C) : 21.5 ± 2					Relative Humidity (%) : 52				
Liquid Temperature (°C) : 21.0 ± 2					Depth of Liquid (cm):>15				
Product: Mobile Phone									
Test Mode: GSM850									
Test Position Head	Antenna Position	Frequency		Frame Power (dBm)	Power Drift (<±0.2)	SAR 1g (W/kg)	Scaling Factor	Scaled SAR 1g (W/kg)	Limit (W/kg)
		Channel	MHz						
Left-Cheek	Fixed	128	824.2	23.43	--	--	1.140	--	1.6
Left-Cheek	Fixed	189	836.4	23.58	-0.05	0.537	1.102	0.592	1.6
Left-Cheek	Fixed	251	848.8	23.74	--	--	1.062	--	1.6
Left-Tilted	Fixed	189	836.4	23.58	-0.05	0.310	1.102	0.342	1.6
Right-Cheek	Fixed	128	824.2	23.43	--	--	1.140	--	1.6
Right-Cheek	Fixed	189	836.4	23.58	0.01	0.361	1.102	0.398	1.6
Right-Cheek	Fixed	251	848.8	23.74	--	--	1.062	--	1.6
Right-Tilted	Fixed	189	836.4	23.58	0.09	0.161	1.102	0.177	1.6

Note: when the 1-g SAR is ≤ 0.8 W/kg, testing for low and high channel is optional, refer to KDB 447498 D01 v05r02.

<b>SAR MEASUREMENT</b>									
Ambient Temperature (°C) : 21.5 ± 2					Relative Humidity (%): 52				
Liquid Temperature (°C) : 21.0 ± 2					Depth of Liquid (cm):>15				
Product: Mobile Phone									
<b>Body-worn Accessory SAR Configurations</b>									
Test Mode: GSM850									
Test Position Body (15mm gap)	Antenna Position	Frequency		Frame Power (dBm)	Power Drift (<±0.2)	SAR 1g (W/kg)	Scaling Factor	Scaled SAR 1g (W/kg)	Limit (W/kg)
		Channel	MHz						
Body-worn	Fixed	128	824.2	23.43	--	--	1.140	--	1.6
Body-worn	Fixed	189	836.4	23.58	-0.04	0.349	1.102	0.385	1.6
Body-worn	Fixed	251	848.8	23.74	--	--	1.062	--	1.6
Test Mode: GPRS850-4slot									
Body-worn	Fixed	128	824.2	25.20	--	--	1.202	--	1.6
Body-worn	Fixed	189	836.4	25.49	-0.20	0.529	1.125	0.595	1.6
Body-worn	Fixed	251	848.8	25.77	--	--	1.054	--	1.6
Front	Fixed	189	836.4	25.49	-0.07	0.306	1.125	0.344	1.6
Note: when the 1-g SAR is ≤ 0.8 W/kg, testing for low and high channel is optional, refer to KDB 447498 D01 v05r02.									

SAR MEASUREMENT									
Ambient Temperature (°C) : 21.5 ± 2					Relative Humidity (%): 52				
Liquid Temperature (°C) : 21.0 ± 2					Depth of Liquid (cm):>15				
Product: Mobile Phone									
Test Mode: PCS1900									
Test Position Head	Antenna Position	Frequency		Frame Power (dBm)	Power Drift (<±0.2)	SAR 1g (W/kg)	Scaling Factor	Scaled SAR 1g (W/kg)	Limit (W/kg)
		Channel	MHz						
Left-Cheek	Fixed	512	1850.2	17.99	0.01	0.899	1.002	0.901	1.6
Left-Cheek	Fixed	661	1880	17.56	0.05	1.1	1.107	1.22	1.6
Left-Cheek	Fixed	810	1909.8	17.31	0.09	1.2	1.172	1.41	1.6
Left-Cheek*	Fixed	810	1909.8	17.31	-0.03	1.01	1.172	1.18	1.6
Left-Tilted	Fixed	512	1850.2	17.99	0.02	0.663	1.002	0.664	1.6
Left-Tilted	Fixed	661	1880	17.56	0.11	0.789	1.107	0.873	1.6
Left-Tilted	Fixed	810	1909.8	17.31	0.09	0.870	1.172	1.02	1.6
Right-Cheek	Fixed	512	1850.2	17.99	--	--	1.002	--	1.6
Right-Cheek	Fixed	661	1880	17.56	0.04	0.714	1.107	0.790	1.6
Right-Cheek	Fixed	810	1909.8	17.31	--	--	1.172	--	1.6
Right-Tilted	Fixed	661	1880.0	17.56	-0.11	0.421	1.107	0.466	1.6

Note1: when the 1-g SAR is ≤ 0.8 W/kg, testing for low and high channel is optional, refer to KDB 447498 D01 v05r02.

2: Highest SAR was repeated if the 1-g SAR is >0.8 W/kg according to KDB 865664 D01v01r03.



SAR MEASUREMENT									
Ambient Temperature (°C) : 21.5 ± 2					Relative Humidity (%): 52				
Liquid Temperature (°C) : 21.0 ± 2					Depth of Liquid (cm):>15				
Product: Mobile Phone									
Body-worn Accessory SAR Configurations									
Test Mode: PCS1900									
Test Position Body (15mm gap)	Antenna Position	Frequency		Frame Power (dBm)	Power Drift (<±0.2)	SAR 1g (W/kg)	Scaling Factor	Scaled SAR 1g (W/kg)	Limit (W/kg )
		Channel	MHz						
Body-worn	Fixed	512	1850.2	17.99	--	--	1.002	--	1.6
Body-worn	Fixed	661	1880	17.56	0.03	0.259	1.107	0.287	1.6
Body-worn	Fixed	810	1909.8	17.31	--	--	1.172	--	1.6
Test Mode: GPRS1900-2slot									
Body-worn	Fixed	512	1850.2	19.62	--	--	1.091	--	1.6
Body-worn	Fixed	661	1880	19.03	-0.14	0.369	1.250	0.461	1.6
Body-worn	Fixed	810	1909.8	18.63	--	--	1.371	--	1.6
Front	Fixed	661	1880	19.03	0.00	0.184	1.250	0.230	1.6
Note: when the 1-g SAR is ≤ 0.8 W/kg, testing for low and high channel is optional, refer to KDB 447498 D01 v05r02.									

**9.2. SAR Test Notes**

**9.2.1. Test position and configuration**

Head SAR was performed with the device configured in the positions according to IEEE1528. Device was tested using a fixed spacing for body-worn accessory testing. A separation distance of 15 mm was considered because the manufacturer has determined that there will be body-worn accessories available in the marketplace for users to support this separation distance.

**9.2.2. Body SAR with Headset**

Per FCC KDB Publication 648474 D04v01r02, SAR was evaluated without a headset connected to the device. Since the standalone reported SAR was ≤ 1.2 W/kg, no additional SAR evaluations using a headset cable were required.

**9.2.3. Simultaneous Transmission Procedures**

This device contains transmitters that may operate simultaneously. Therefore simultaneous transmission analysis is required. Per FCC KDB 447498 D01v05r02 IV.C.1.iii, simultaneous transmission SAR test exclusion may be applied when the sum of the 1-g SAR for all the simultaneous transmitting antennas in a specific a physical test configuration is ≤ 1.6W/kg. When standalone SAR is not required to be measured, per FCC KDB 447498 D01v05r02 4.3.2 2, the following equation must be used to estimate the standalone 1g SAR for simultaneous transmission assessment involving that transmitter.

$$\text{Estimated SAR} = \frac{\sqrt{f(\text{GHz})}}{7.5} * \frac{(\text{Max Power of channel, mW})}{\text{Min. Separation Distance, mm}}$$

**Estimated SAR for Bluetooth**

Mode	Frequency	Maximum Allowed Power	Separation Distance (Head)	Estimated SAR (Held-to-Ear)	Separation Distance (Body)	Estimated SAR (Body)
	[MHz]	[dBm]	[mm]	[W/kg]	[mm]	[W/kg]
Bluetooth	2480	6	5	0.167	15	0.056

**9.2.4. Simultaneous Transmission Analysis**

Simultaneous Transmission Scenario with Bluetooth

Configuration	Mode	Max. Scaled SAR (W/kg)	Bluetooth SAR (W/kg)	$\Sigma$ SAR (W/kg)
Head	GSM850	0.591	0.167	0.758
Head	PCS1900	1.41	0.167	1.577
Body-Worn	GSM850	0.595	0.056	0.651
Body-Worn	PCS1900	0.461	0.056	0.517

Note 1: Bluetooth SAR was not required to be measured per FCC KDB 447498. Estimated SAR results were used in the above table to determine simultaneous transmission SAR test exclusion.

2: Body worn at 15mm.

### **9.2.5. Simultaneous Transmission Conclusion**

The above numerical summed SAR results for all the worst-case simultaneous transmission conditions were below the SAR limit. Therefore, the above analysis is sufficient to determine that simultaneous transmission cases will not exceed the SAR limit and therefore no measured volumetric simultaneous SAR summation is required per FCC KDB Publication 447498 D01v05r02.

## Appendix A. SAR System Validation Data

Date/Time: 09-09-2014

Test Laboratory: QuieTek Lab

System Check Head 835MHz

**DUT: Dipole 835 MHz D835V2; Type: D835V2**

Communication System: UID 0, CW; Communication System Band: D835(835.0MHz); Duty Cycle: 1:1;

Frequency: 835 MHz; Medium parameters used:  $f = 835 \text{ MHz}$ ;  $\sigma = 0.89 \text{ S/m}$ ;  $\epsilon_r = 41.26$ ;  $\rho = 1000 \text{ kg/m}^3$  ;

Phantom section: Flat Section ; Input Power=250mW

Ambient temperature ( $^{\circ}\text{C}$ ): 21.5, Liquid temperature ( $^{\circ}\text{C}$ ): 21.0

DASY5 Configuration:

- Probe: EX3DV4 - SN3710; ConvF(9.56, 9.56, 9.56); Calibrated: 04/03/2014;
- Sensor-Surface: 4mm (Mechanical Surface Detection)
- Electronics: DAE4 Sn1220; Calibrated: 22/01/2014
- Phantom: SAM2; Type: SAM; Serial: TP1562
- Measurement SW: DASY52, Version 52.8 (7); SEMCAD X Version 14.6.10 (7164)

**Configuration/System Check Head 835MHz/Area Scan (6x19x1):** Measurement grid: dx=10mm, dy=10mm, Maximum value of SAR (measured) = 2.52 W/kg

**Configuration/System Check Head 835MHz/Zoom Scan (7x7x7)/Cube 0:** Measurement grid: dx=5mm, dy=5mm, dz=5mm, Reference Value = 54.175 V/m; Power Drift = 0.12 dB

Peak SAR (extrapolated) = 3.68 W/kg

**SAR(1 g) = 2.45 W/kg; SAR(10 g) = 1.61 W/kg** Maximum value of SAR (measured) = 2.64 W/kg

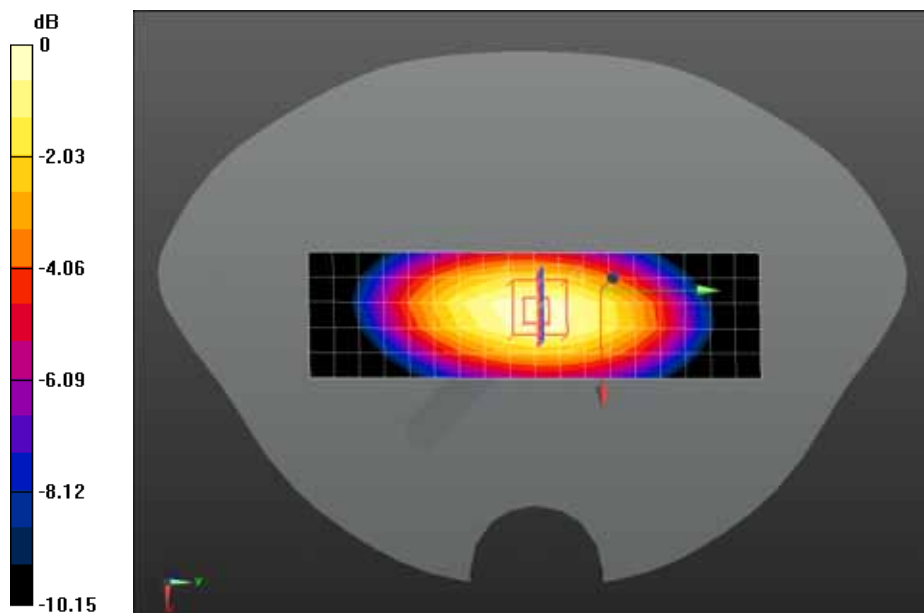

0 dB = 2.64 W/kg = 4.22 dBW/kg

Date/Time: 09-09-2014

Test Laboratory: QuieTek Lab

System Check Head 1900MHz

**DUT: Dipole 1900 MHz D1900V2; Type: D1900V2**

Communication System: UID 10000, CW; Communication System Band: D1900 (1900.0 MHz); Duty Cycle: 1:1; Frequency: 1900 MHz; Medium parameters used:  $f = 1900$  MHz;  $\sigma = 1.44$  S/m;  $\epsilon_r = 38.72$ ;  $\rho = 1000$  kg/m<sup>3</sup> ; Phantom section: Flat Section ; Input Power=250mW

Ambient temperature (°C): 21.5, Liquid temperature (°C): 21.0

DASY5 Configuration:

- Probe: EX3DV4 - SN3710; ConvF(7.72, 7.72, 7.72); Calibrated: 04/03/2014;
- Sensor-Surface: 4mm (Mechanical Surface Detection)
- Electronics: DAE4 Sn1220; Calibrated: 22/01/2014
- Phantom: SAM2; Type: SAM; Serial: TP1562
- Measurement SW: DASY52, Version 52.8 (7); SEMCAD X Version 14.6.10 (7164)

**Configuration/System Check Head 1900MHz/Area Scan (6x11x1):** Measurement grid: dx=10mm, dy=10mm

Maximum value of SAR (measured) = 9.63 W/kg

**Configuration/System Check Head 1900MHz/Zoom Scan (7x7x7)/Cube 0:** Measurement grid: dx=5mm, dy=5mm, dz=5mm, Reference Value = 85.802 V/m; Power Drift = 0.05 dB

Peak SAR (extrapolated) = 18.6 W/kg

**SAR(1 g) = 9.76 W/kg; SAR(10 g) = 4.97 W/kg** Maximum value of SAR (measured) = 11.0 W/kg

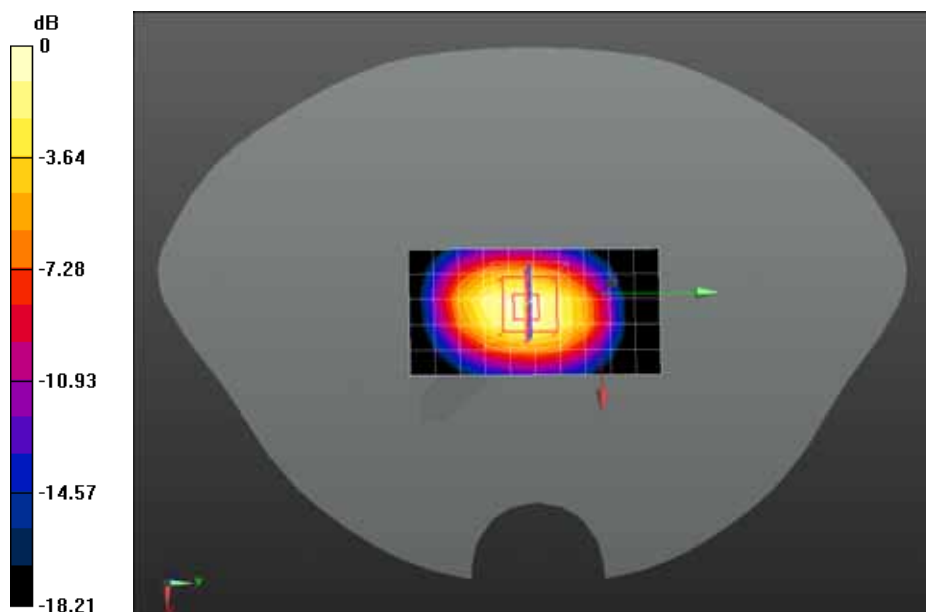

0 dB = 11.0 W/kg = 10.41 dBW/kg

Date/Time: 09-09-2014

Test Laboratory: QuieTek Lab

System Check Body 835MHz

**DUT: Dipole 835 MHz D835V2; Type: D835V2**

Communication System: UID 10000, CW; Communication System Band: D835 (835.0 MHz); Duty Cycle: 1:1; Frequency: 835 MHz; Medium parameters used:  $f = 835$  MHz;  $\sigma = 0.98$  S/m;  $\epsilon_r = 53.84$ ;  $\rho = 1000$  kg/m<sup>3</sup> ; Phantom section: Flat Section ; Input Power=250mW

Ambient temperature (°C): 21.5, Liquid temperature (°C): 21.0

DASY5 Configuration:

- Probe: EX3DV4 - SN3710; ConvF(9.22, 9.22, 9.22); Calibrated: 04/03/2014;
- Sensor-Surface: 4mm (Mechanical Surface Detection)
- Electronics: DAE4 Sn1220; Calibrated: 22/01/2014
- Phantom: SAM2; Type: SAM; Serial: TP1562
- Measurement SW: DASY52, Version 52.8 (7); SEMCAD X Version 14.6.10 (7164)

**Configuration/System Check Body 835MHz/Area Scan (8x17x1):** Measurement grid: dx=10mm, dy=10mm

Maximum value of SAR (measured) = 2.51 W/kg

**Configuration/System Check Body 835MHz/Zoom Scan (7x7x7)/Cube 0:** Measurement grid: dx=5mm, dy=5mm, dz=5mm, Reference Value = 52.328 V/m; Power Drift = 0.03 dB

Peak SAR (extrapolated) = 3.78 W/kg

**SAR(1 g) = 2.5 W/kg; SAR(10 g) = 1.63 W/kg** Maximum value of SAR (measured) = 2.70 W/kg

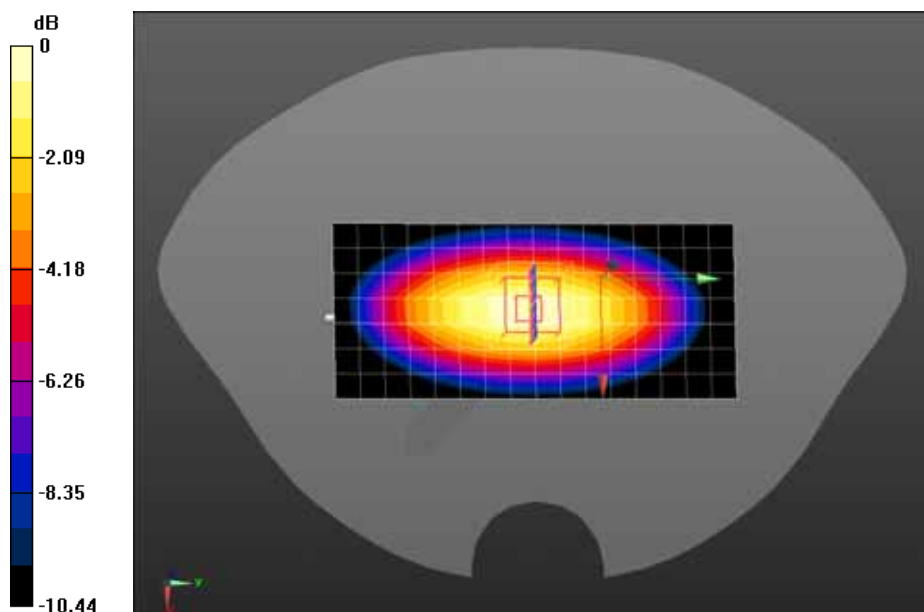

0 dB = 2.70 W/kg = 4.31 dBW/kg

Date/Time: 09-09-2014

Test Laboratory: QuieTek Lab

System Check Body 1900MHz

**DUT: Dipole 1900 MHz D1900V2; Type: D1900V2**

Communication System: UID 0, CW; Communication System Band: D1900(1900MHz); Duty Cycle: 1:1;

Frequency: 1900 MHz; Medium parameters used:  $f = 1900$  MHz;  $\sigma = 1.5$  S/m;  $\epsilon_r = 52.02$ ;  $\rho = 1000$  kg/m<sup>3</sup> ;

Phantom section: Flat Section ; Input Power=250mW

Ambient temperature (°C): 21.5, Liquid temperature (°C): 21.0

DASY5 Configuration:

- Probe: EX3DV4 - SN3710; ConvF(7.25, 7.25, 7.25); Calibrated: 04/03/2014;
- Sensor-Surface: 4mm (Mechanical Surface Detection)
- Electronics: DAE4 Sn1220; Calibrated: 22/01/2014
- Phantom: SAM1; Type: SAM; Serial: TP1561
- Measurement SW: DASY52, Version 52.8 (7); SEMCAD X Version 14.6.10 (7164)

**Configuration/System Check Body 1900MHz/Area Scan (7x11x1):** Measurement grid: dx=10mm, dy=10mm

Maximum value of SAR (measured) = 11.5 W/kg

**Configuration/System Check Body 1900MHz/Zoom Scan (7x7x7)/Cube 0:** Measurement grid: dx=5mm, dy=5mm, dz=5mm, Reference Value = 87.706 V/m; Power Drift = 0.03 dB

Peak SAR (extrapolated) = 19.3 W/kg

**SAR(1 g) = 10.4 W/kg; SAR(10 g) = 5.37 W/kg** Maximum value of SAR (measured) = 11.7 W/kg

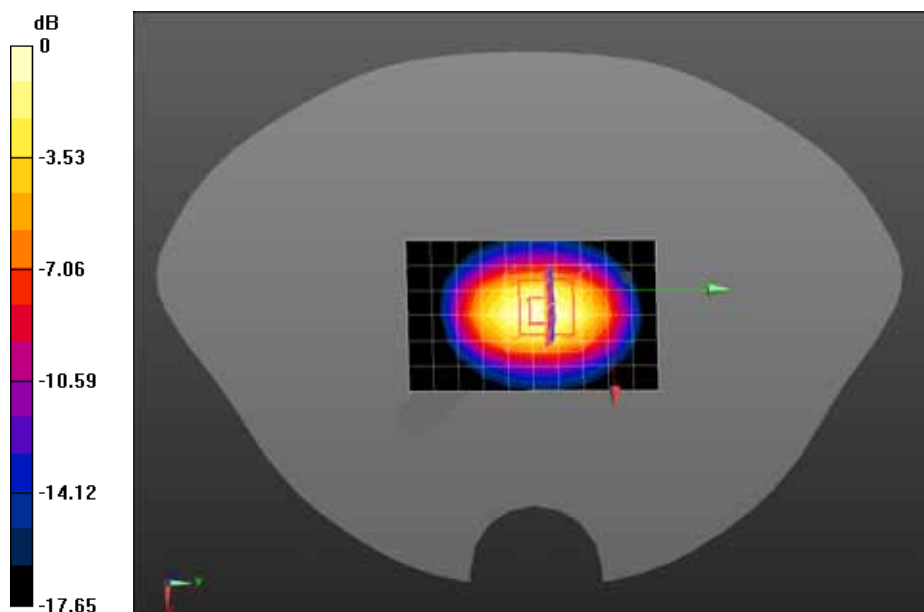

0 dB = 11.7 W/kg = 10.68 dBW/kg



**Appendix B. SAR measurement Data**

**Date/Time: 09-09-2014**

Test Laboratory: QuieTek Lab

GSM850 Mid Touch-Left

**DUT: Mobile Phone; Type: F1010**

Communication System: UID 0, Generic GSM; Communication System Band: GSM850; Duty Cycle: 1:8.3;

Frequency: 836.4 MHz; Medium parameters used:  $f = 836.4$  MHz;  $\sigma = 0.89$  S/m;  $\epsilon_r = 41.24$ ;  $\rho = 1000$  kg/m<sup>3</sup> ;

Phantom section: Left Section

Ambient temperature (°C): 21.5, Liquid temperature (°C): 21.0

DASY5 Configuration:

- Probe: EX3DV4 - SN3710; ConvF(9.56, 9.56, 9.56); Calibrated: 04/03/2014;
- Sensor-Surface: 4mm (Mechanical Surface Detection)
- Electronics: DAE4 Sn1220; Calibrated: 22/01/2014
- Phantom: SAM2; Type: SAM; Serial: TP1562
- Measurement SW: DASY52, Version 52.8 (7); SEMCAD X Version 14.6.10 (7164)

**Configuration/GSM850 Mid Touch-Left/Area Scan (6x10x1):** Measurement grid: dx=15mm, dy=15mm

Maximum value of SAR (measured) = 0.573 W/kg

**Configuration/GSM850 Mid Touch-Left/Zoom Scan (5x5x7)/Cube 0:** Measurement grid: dx=8mm,

dy=8mm, dz=5mm, Reference Value = 17.172 V/m; Power Drift = -0.05 dB

Peak SAR (extrapolated) = 0.803 W/kg

**SAR(1 g) = 0.537 W/kg; SAR(10 g) = 0.371 W/kg** Maximum value of SAR (measured) = 0.564 W/kg

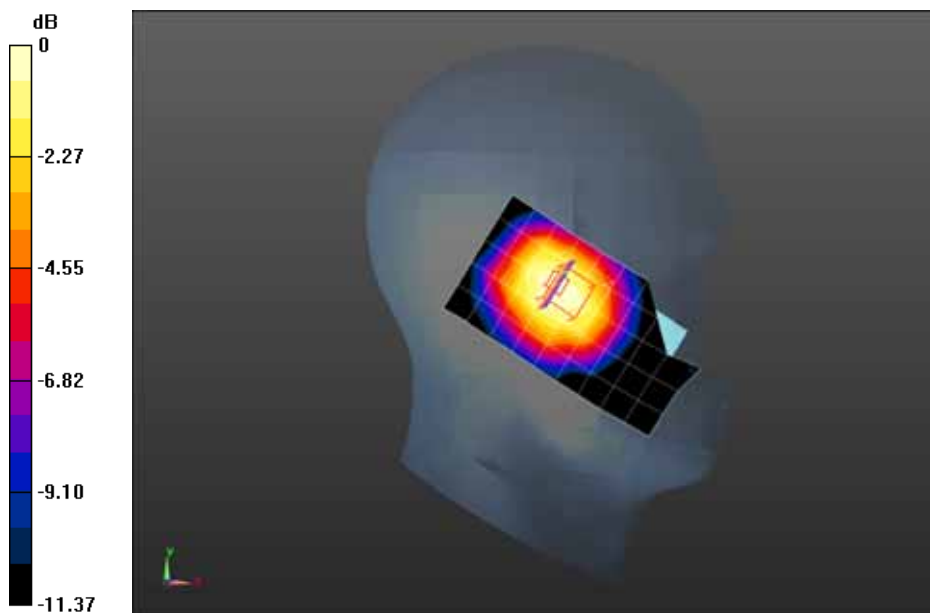

0 dB = 0.564 W/kg = -2.49 dBW/kg

Date/Time: 09-09-2014

Test Laboratory: QuieTek Lab

GSM850 Mid Tilt-Left

**DUT: Mobile Phone; Type: F1010**

Communication System: UID 0, Generic GSM; Communication System Band: GSM850; Duty Cycle: 1:8.3; Frequency: 836.4 MHz; Medium parameters used:  $f = 836.4$  MHz;  $\sigma = 0.89$  S/m;  $\epsilon_r = 41.24$ ;  $\rho = 1000$  kg/m<sup>3</sup> ; Phantom section: Left Section

Ambient temperature (°C): 21.5, Liquid temperature (°C): 21.0

DASY5 Configuration:

- Probe: EX3DV4 - SN3710; ConvF(9.56, 9.56, 9.56); Calibrated: 04/03/2014;
- Sensor-Surface: 4mm (Mechanical Surface Detection)
- Electronics: DAE4 Sn1220; Calibrated: 22/01/2014
- Phantom: SAM2; Type: SAM; Serial: TP1562
- Measurement SW: DASY52, Version 52.8 (7); SEMCAD X Version 14.6.10 (7164)

**Configuration/GSM850 Mid Tilt-Left/Area Scan (6x10x1):** Measurement grid: dx=15mm, dy=15mm

Maximum value of SAR (measured) = 0.327 W/kg

**Configuration/GSM850 Mid Tilt-Left/Zoom Scan (5x5x7)/Cube 0:** Measurement grid: dx=8mm, dy=8mm, dz=5mm, Reference Value = 13.450 V/m; Power Drift = -0.05 dB

Peak SAR (extrapolated) = 0.471 W/kg

**SAR(1 g) = 0.310 W/kg; SAR(10 g) = 0.209 W/kg** Maximum value of SAR (measured) = 0.325 W/kg

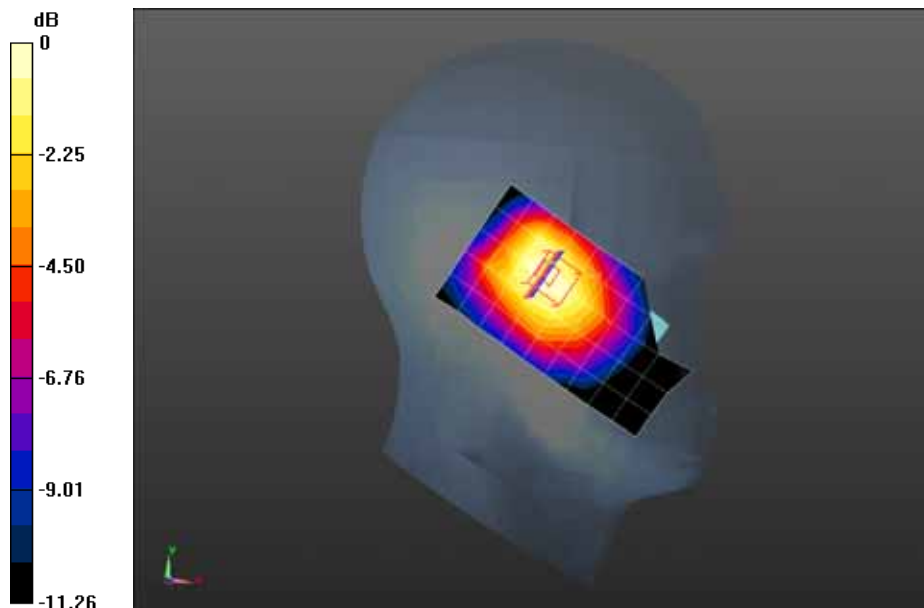

0 dB = 0.325 W/kg = -4.88 dBW/kg

Date/Time: 09-09-2014

Test Laboratory: QuieTek Lab

GSM850 Mid Touch-Right

**DUT: Mobile Phone; Type: F1010**

Communication System: UID 0, Generic GSM; Communication System Band: GSM850; Duty Cycle: 1:8.3; Frequency: 836.4 MHz; Medium parameters used:  $f = 836.4$  MHz;  $\sigma = 0.89$  S/m;  $\epsilon_r = 41.24$ ;  $\rho = 1000$  kg/m<sup>3</sup> ; Phantom section: Right Section

Ambient temperature (°C): 21.5, Liquid temperature (°C): 21.0

DASY5 Configuration:

- Probe: EX3DV4 - SN3710; ConvF(9.56, 9.56, 9.56); Calibrated: 04/03/2014;
- Sensor-Surface: 4mm (Mechanical Surface Detection)
- Electronics: DAE4 Sn1220; Calibrated: 22/01/2014
- Phantom: SAM2; Type: SAM; Serial: TP1562
- Measurement SW: DASY52, Version 52.8 (7); SEMCAD X Version 14.6.10 (7164)

**Configuration/GSM850 Mid Touch-Right/Area Scan (6x10x1):** Measurement grid: dx=15mm, dy=15mm

Maximum value of SAR (measured) = 0.338 W/kg

**Configuration/GSM850 Mid Touch-Right/Zoom Scan (5x5x7)/Cube 0:** Measurement grid: dx=8mm, dy=8mm, dz=5mm, Reference Value = 15.964 V/m; Power Drift = 0.01 dB

Peak SAR (extrapolated) = 0.485 W/kg

**SAR(1 g) = 0.361 W/kg; SAR(10 g) = 0.248 W/kg** Maximum value of SAR (measured) = 0.395 W/kg

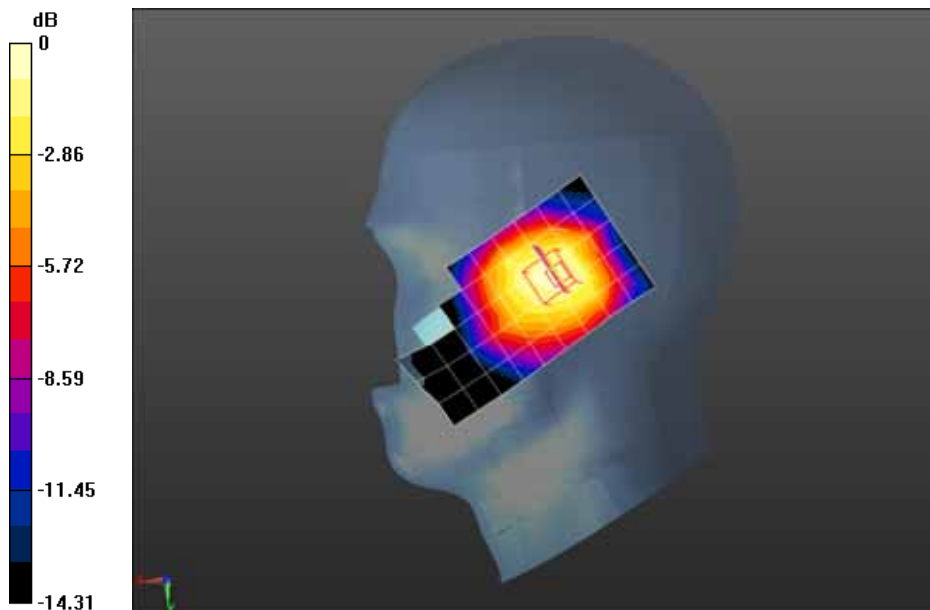

0 dB = 0.395 W/kg = -4.03 dBW/kg

Date/Time: 09-09-2014

Test Laboratory: QuieTek Lab

GSM850 Mid Tilt-Right

**DUT: Mobile Phone; Type: F1010**

Communication System: UID 0, Generic GSM; Communication System Band: GSM850; Duty Cycle: 1:8.3; Frequency: 836.4 MHz; Medium parameters used:  $f = 836.4$  MHz;  $\sigma = 0.89$  S/m;  $\epsilon_r = 41.24$ ;  $\rho = 1000$  kg/m<sup>3</sup> ; Phantom section: Right Section

Ambient temperature (°C): 21.5, Liquid temperature (°C): 21.0

DASY5 Configuration:

- Probe: EX3DV4 - SN3710; ConvF(9.56, 9.56, 9.56); Calibrated: 04/03/2014;
- Sensor-Surface: 4mm (Mechanical Surface Detection)
- Electronics: DAE4 Sn1220; Calibrated: 22/01/2014
- Phantom: SAM2; Type: SAM; Serial: TP1562
- Measurement SW: DASY52, Version 52.8 (7); SEMCAD X Version 14.6.10 (7164)

**Configuration/GSM850 Mid Tilt-Right/Area Scan (6x10x1):** Measurement grid: dx=15mm, dy=15mm

Maximum value of SAR (measured) = 0.159 W/kg

**Configuration/GSM850 Mid Tilt-Right/Zoom Scan (5x5x7)/Cube 0:** Measurement grid: dx=8mm, dy=8mm, dz=5mm, Reference Value = 11.683 V/m; Power Drift = 0.09 dB

Peak SAR (extrapolated) = 0.208 W/kg

**SAR(1 g) = 0.161 W/kg; SAR(10 g) = 0.110 W/kg** Maximum value of SAR (measured) = 0.176 W/kg

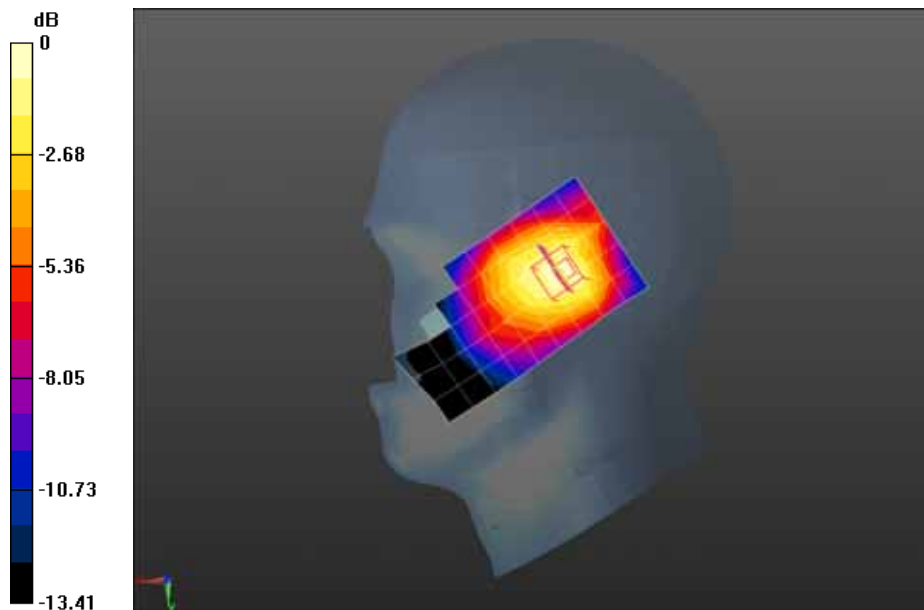

0 dB = 0.176 W/kg = -7.54 dBW/kg

Date/Time: 09-09-2014

Test Laboratory: QuieTek Lab

GSM850 Mid Body-Back

**DUT: Mobile Phone; Type: F1010**

Communication System: UID 0, Generic GSM; Communication System Band: GSM850; Duty Cycle: 1:8.3; Frequency: 836.4 MHz; Medium parameters used:  $f = 836.4$  MHz;  $\sigma = 0.98$  S/m;  $\epsilon_r = 53.83$ ;  $\rho = 1000$  kg/m<sup>3</sup> ; Phantom section: Flat Section

Ambient temperature (°C): 21.5, Liquid temperature (°C): 21.0

DASY5 Configuration:

- Probe: EX3DV4 - SN3710; ConvF(9.22, 9.22, 9.22); Calibrated: 04/03/2014;
- Sensor-Surface: 4mm (Mechanical Surface Detection)
- Electronics: DAE4 Sn1220; Calibrated: 22/01/2014
- Phantom: SAM2; Type: SAM; Serial: TP1562
- Measurement SW: DASY52, Version 52.8 (7); SEMCAD X Version 14.6.10 (7164)

**Configuration/GSM850 Mid Body-Back/Area Scan (6x10x1):** Measurement grid: dx=15mm, dy=15mm

Maximum value of SAR (measured) = 0.371 W/kg

**Configuration/GSM850 Mid Body-Back/Zoom Scan (5x5x7)/Cube 0:** Measurement grid: dx=8mm, dy=8mm, dz=5mm, Reference Value = 18.970 V/m; Power Drift = -0.04 dB

Peak SAR (extrapolated) = 0.476 W/kg

**SAR(1 g) = 0.349 W/kg; SAR(10 g) = 0.245 W/kg** Maximum value of SAR (measured) = 0.373 W/kg

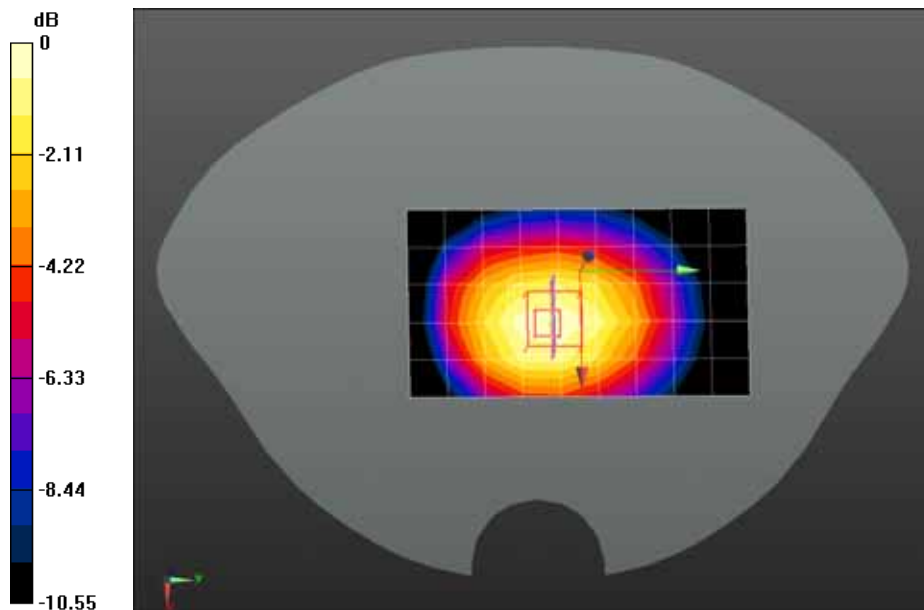

0 dB = 0.373 W/kg = -4.28 dBW/kg

Date/Time: 09-09-2014

Test Laboratory: QuieTek Lab

GPRS850 Mid Body-Back(4up)

**DUT: Mobile Phone; Type: F1010**

Communication System: UID 0, GPRS/EGPRS-4 Slot (0); Communication System Band: GSM 850; Duty Cycle: 1:2.1 ; Frequency: 836.4 MHz; Medium parameters used:  $f = 836.4$  MHz;  $\sigma = 0.98$  S/m;  $\epsilon_r = 53.83$ ;  $\rho = 1000$  kg/m<sup>3</sup> ; Phantom section: Flat Section

Ambient temperature (°C): 21.5, Liquid temperature (°C): 21.0

DASY5 Configuration:

- Probe: EX3DV4 - SN3710; ConvF(9.22, 9.22, 9.22); Calibrated: 04/03/2014;
- Sensor-Surface: 4mm (Mechanical Surface Detection)
- Electronics: DAE4 Sn1220; Calibrated: 22/01/2014
- Phantom: SAM2; Type: SAM; Serial: TP1562
- Measurement SW: DASY52, Version 52.8 (7); SEMCAD X Version 14.6.10 (7164)

**Configuration/GPRS850 Mid Body-Back/Area Scan (6x10x1):** Measurement grid: dx=15mm, dy=15mm

Maximum value of SAR (measured) = 0.570 W/kg

**Configuration/GPRS850 Mid Body-Back/Zoom Scan (5x5x7)/Cube 0:** Measurement grid: dx=8mm, dy=8mm, dz=5mm, Reference Value = 23.743 V/m; Power Drift = -0.20 dB

Peak SAR (extrapolated) = 0.723 W/kg

**SAR(1 g) = 0.529 W/kg; SAR(10 g) = 0.373 W/kg** Maximum value of SAR (measured) = 0.558 W/kg

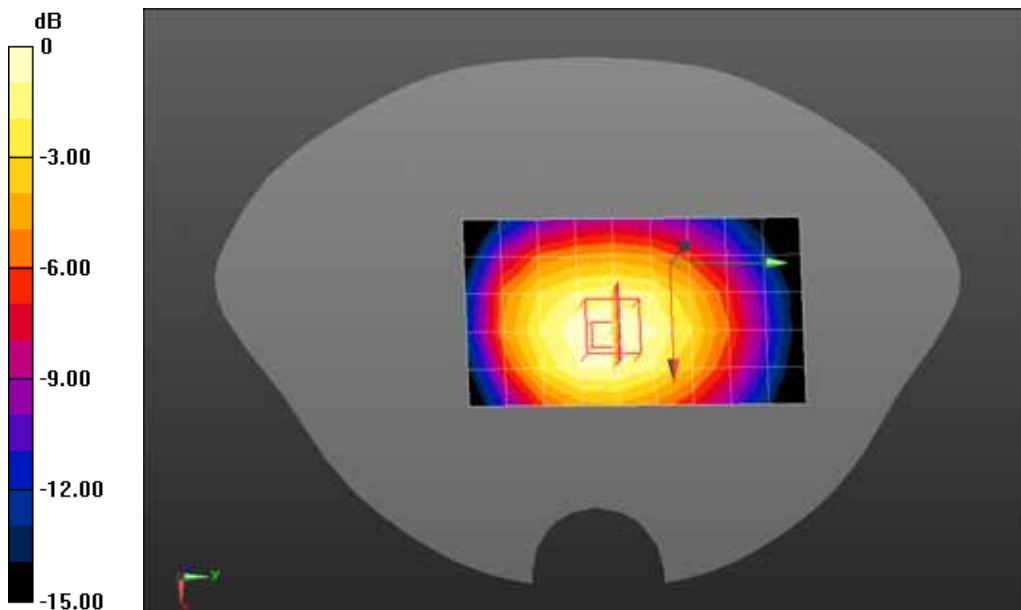

0 dB = 0.558 W/kg = -2.53 dBW/kg

Z-Axis Plot

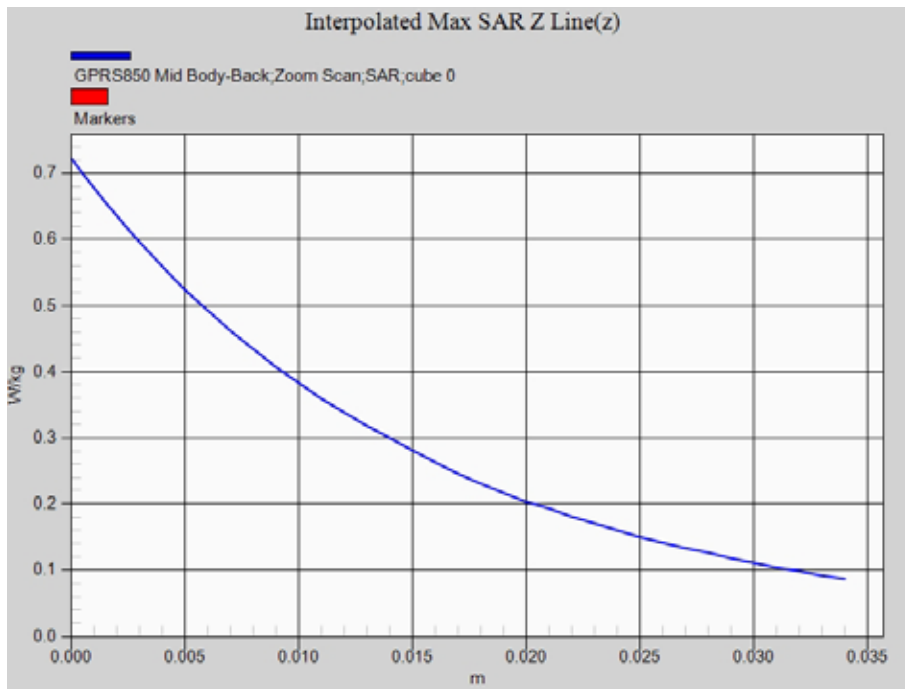

Date/Time: 09-09-2014

Test Laboratory: QuieTek Lab

GPRS850 Mid Body-Front(4up)

**DUT: Mobile Phone; Type: F1010**

Communication System: UID 0, GPRS/EGPRS-4 Slot (0); Communication System Band: GSM 850; Duty Cycle: 1:2.1 ; Frequency: 836.4 MHz; Medium parameters used:  $f = 836.4$  MHz;  $\sigma = 0.98$  S/m;  $\epsilon_r = 53.83$ ;  $\rho = 1000$  kg/m<sup>3</sup> ; Phantom section: Flat Section

Ambient temperature (°C): 21.5, Liquid temperature (°C): 21.0

DASY5 Configuration:

- Probe: EX3DV4 - SN3710; ConvF(9.22, 9.22, 9.22); Calibrated: 04/03/2014;
- Sensor-Surface: 4mm (Mechanical Surface Detection)
- Electronics: DAE4 Sn1220; Calibrated: 22/01/2014
- Phantom: SAM2; Type: SAM; Serial: TP1562
- Measurement SW: DASY52, Version 52.8 (7); SEMCAD X Version 14.6.10 (7164)

**Configuration/GPRS850 Mid Body-Front/Area Scan (6x10x1):** Measurement grid: dx=15mm, dy=15mm

Maximum value of SAR (measured) = 0.323 W/kg

**Configuration/GPRS850 Mid Body-Front/Zoom Scan (5x5x7)/Cube 0:** Measurement grid: dx=8mm, dy=8mm, dz=5mm, Reference Value = 17.521 V/m; Power Drift = -0.07 dB

Peak SAR (extrapolated) = 0.412 W/kg

**SAR(1 g) = 0.306 W/kg; SAR(10 g) = 0.218 W/kg** Maximum value of SAR (measured) = 0.325 W/kg

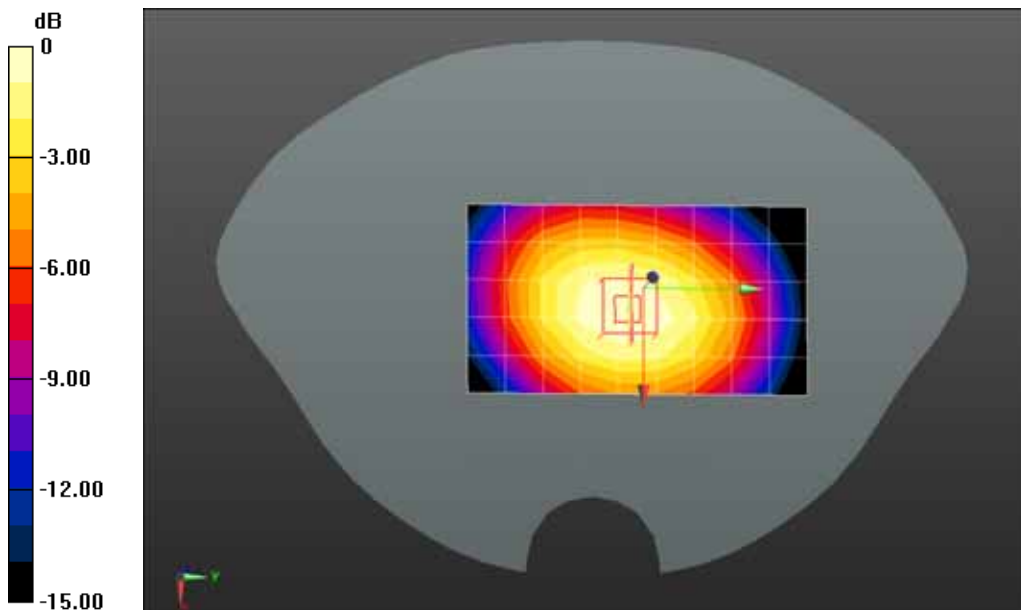

0 dB = 0.325 W/kg = -4.88 dBW/kg



Date/Time: 09-09-2014

Test Laboratory: QuieTek Lab

PCS1900 Low Touch-Left

**DUT: Mobile Phone; Type: F1010**

Communication System: UID 0, Generic GSM (0); Communication System Band: PCS1900; Duty Cycle: 1:8.3; Frequency: 1850.2 MHz; Medium parameters used:  $f = 1850.2$  MHz;  $\sigma = 1.41$  S/m;  $\epsilon_r = 38.94$ ;  $\rho = 1000$  kg/m<sup>3</sup> ; Phantom section: Left Section

Ambient temperature (°C): 21.5, Liquid temperature (°C): 21.0

DASY5 Configuration:

- Probe: EX3DV4 - SN3710; ConvF(7.72, 7.72, 7.72); Calibrated: 04/03/2014;
- Sensor-Surface: 4mm (Mechanical Surface Detection)
- Electronics: DAE4 Sn1220; Calibrated: 22/01/2014
- Phantom: SAM1; Type: SAM; Serial: TP1561
- Measurement SW: DASY52, Version 52.8 (7); SEMCAD X Version 14.6.10 (7164)

**Configuration/PCS1900 Low Touch-Left/Area Scan (6x10x1):** Measurement grid: dx=15mm, dy=15mm

Maximum value of SAR (measured) = 0.910 W/kg

**Configuration/PCS1900 Low Touch-Left/Zoom Scan (5x5x7)/Cube 0:** Measurement grid: dx=8mm, dy=8mm, dz=5mm, Reference Value = 14.145 V/m; Power Drift = 0.01 dB

Peak SAR (extrapolated) = 1.88 W/kg

**SAR(1 g) = 0.899 W/kg; SAR(10 g) = 0.435 W/kg** Maximum value of SAR (measured) = 1.01 W/kg

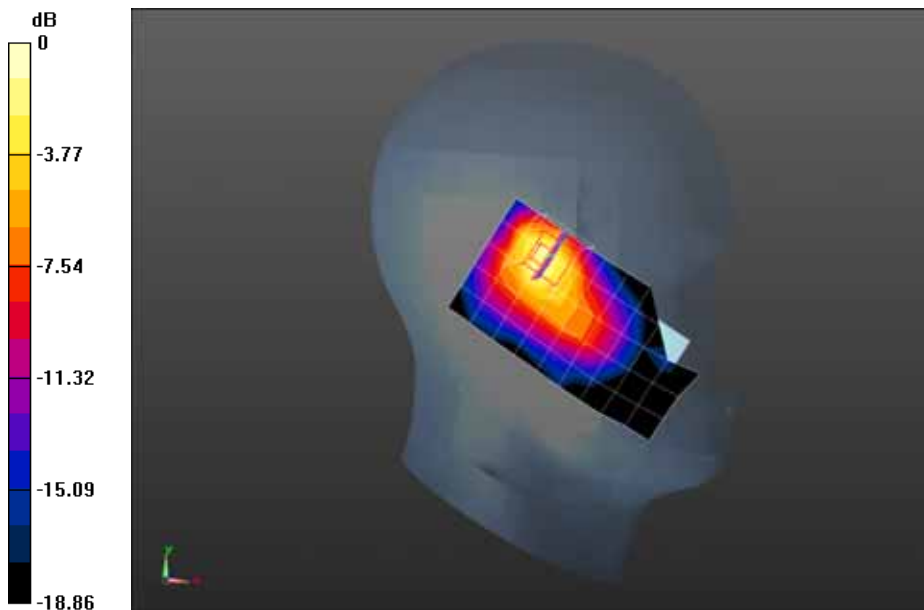

0 dB = 1.01 W/kg = 0.04 dBW/kg

Date/Time: 09-09-2014

Test Laboratory: QuieTek Lab

PCS1900 Mid Touch-Left

**DUT: Mobile Phone; Type: F1010**

Communication System: UID 0, Generic GSM; Communication System Band: PCS1900; Duty Cycle: 1:8.3; Frequency: 1880 MHz; Medium parameters used:  $f = 1880$  MHz;  $\sigma = 1.42$  S/m;  $\epsilon_r = 38.85$ ;  $\rho = 1000$  kg/m<sup>3</sup>; Phantom section: Left Section

Ambient temperature (°C): 21.5, Liquid temperature (°C): 21.0

DASY5 Configuration:

- Probe: EX3DV4 - SN3710; ConvF(7.72, 7.72, 7.72); Calibrated: 04/03/2014;
- Sensor-Surface: 4mm (Mechanical Surface Detection)
- Electronics: DAE4 Sn1220; Calibrated: 22/01/2014
- Phantom: SAM1; Type: SAM; Serial: TP1561
- Measurement SW: DASY52, Version 52.8 (7); SEMCAD X Version 14.6.10 (7164)

**Configuration/PCS1900 Mid Touch-Left/Area Scan (6x10x1):** Measurement grid: dx=15mm, dy=15mm

Maximum value of SAR (measured) = 1.12 W/kg

**Configuration/PCS1900 Mid Touch-Left/Zoom Scan (5x5x7)/Cube 0:** Measurement grid: dx=8mm, dy=8mm, dz=5mm, Reference Value = 14.941 V/m; Power Drift = 0.25 dB

Peak SAR (extrapolated) = 2.31 W/kg

**SAR(1 g) = 1.1 W/kg; SAR(10 g) = 0.529 W/kg** Maximum value of SAR (measured) = 1.22 W/kg

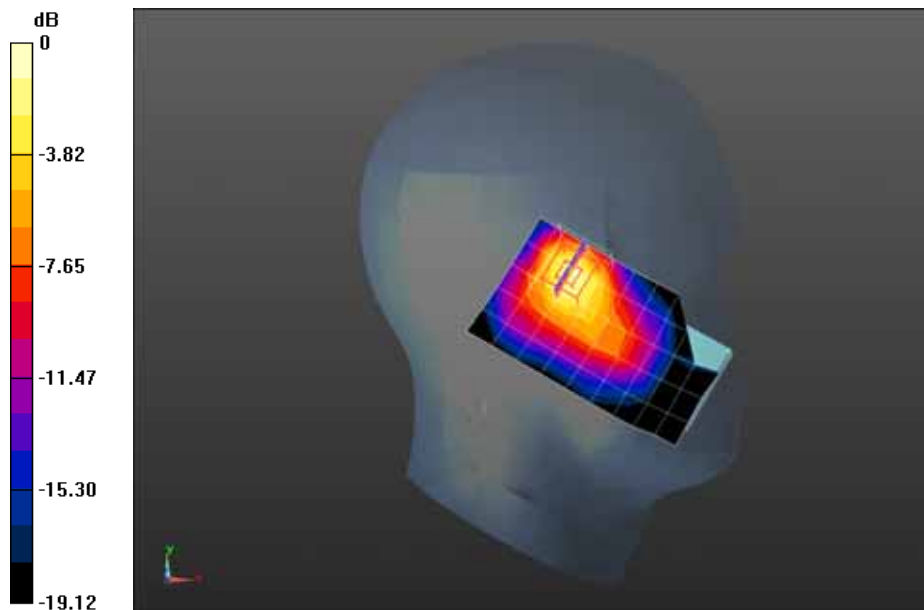

0 dB = 1.22 W/kg = 0.86 dBW/kg

Date/Time: 09-09-2014

Test Laboratory: QuieTek Lab

PCS1900 High Touch-Left

**DUT: Mobile Phone; Type: F1010**

Communication System: UID 0, Generic GSM (0); Communication System Band: PCS1900; Duty Cycle: 1:8.3; Frequency: 1909.8 MHz; Medium parameters used:  $f = 1909.8$  MHz;  $\sigma = 1.45$  S/m;  $\epsilon_r = 38.7$ ;  $\rho = 1000$  kg/m<sup>3</sup> ; Phantom section: Left Section

Ambient temperature (°C): 21.5, Liquid temperature (°C): 21.0

DASY5 Configuration:

- Probe: EX3DV4 - SN3710; ConvF(7.72, 7.72, 7.72); Calibrated: 04/03/2014;
- Sensor-Surface: 4mm (Mechanical Surface Detection)
- Electronics: DAE4 Sn1220; Calibrated: 22/01/2014
- Phantom: SAM1; Type: SAM; Serial: TP1561
- Measurement SW: DASY52, Version 52.8 (7); SEMCAD X Version 14.6.10 (7164)

**Configuration/PCS1900 High Touch-Left/Area Scan (6x10x1):** Measurement grid: dx=15mm, dy=15mm

Maximum value of SAR (measured) = 1.22 W/kg

**Configuration/PCS1900 High Touch-Left/Zoom Scan (5x5x7)/Cube 0:** Measurement grid: dx=8mm, dy=8mm, dz=5mm, Reference Value = 14.856 V/m; Power Drift = 0.09 dB

Peak SAR (extrapolated) = 2.54 W/kg

**SAR(1 g) = 1.2 W/kg; SAR(10 g) = 0.571 W/kg** Maximum value of SAR (measured) = 1.34 W/kg

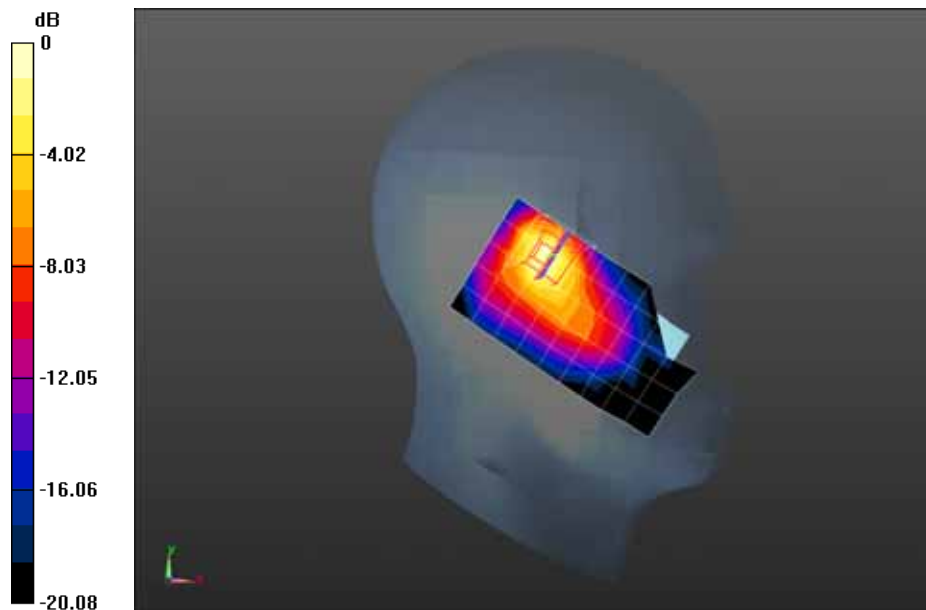

0 dB = 1.34 W/kg = 1.27 dBW/kg

Z-Axis Plot

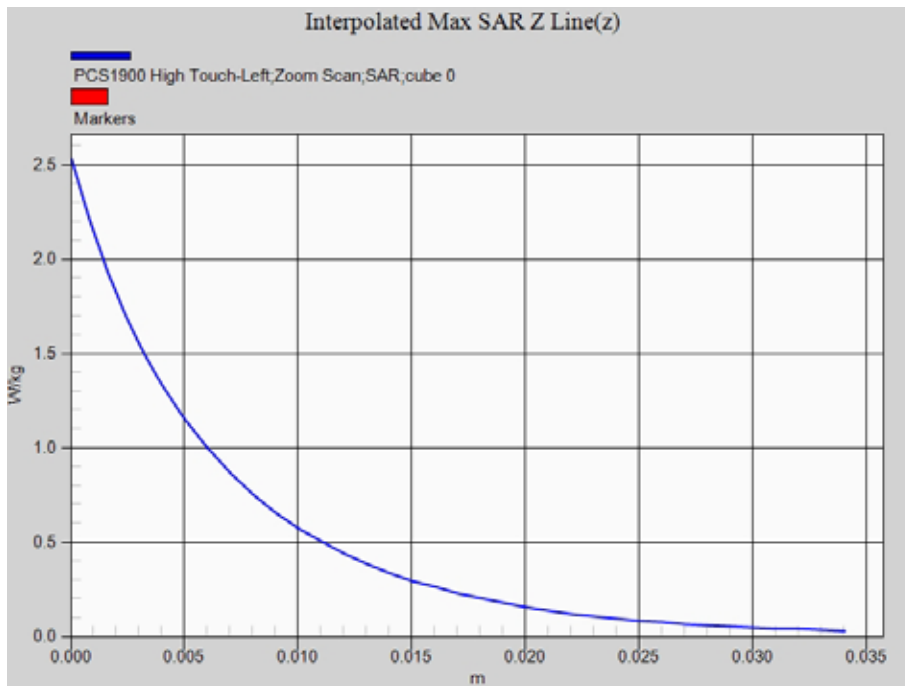

Date/Time: 09-09-2014

Test Laboratory: QuieTek Lab

PCS1900 High Touch-Left\*

**DUT: Mobile Phone; Type: F1010**

Communication System: UID 0, Generic GSM (0); Communication System Band: PCS1900; Duty Cycle: 1:8.3; Frequency: 1909.8 MHz; Medium parameters used:  $f = 1909.8$  MHz;  $\sigma = 1.45$  S/m;  $\epsilon_r = 38.7$ ;  $\rho = 1000$  kg/m<sup>3</sup> ; Phantom section: Left Section

Ambient temperature (°C): 21.5, Liquid temperature (°C): 21.0

DASY5 Configuration:

- Probe: EX3DV4 - SN3710; ConvF(7.72, 7.72, 7.72); Calibrated: 04/03/2014;
- Sensor-Surface: 4mm (Mechanical Surface Detection)
- Electronics: DAE4 Sn1220; Calibrated: 22/01/2014
- Phantom: SAM1; Type: SAM; Serial: TP1561
- Measurement SW: DASY52, Version 52.8 (7); SEMCAD X Version 14.6.10 (7164)

**Configuration/PCS1900 High Touch-Left/Area Scan (6x10x1):** Measurement grid: dx=15mm, dy=15mm

Maximum value of SAR (measured) = 1.10 W/kg

**Configuration/PCS1900 High Touch-Left/Zoom Scan (5x5x7)/Cube 0:** Measurement grid: dx=8mm, dy=8mm, dz=5mm, Reference Value = 12.819 V/m; Power Drift = -0.03 dB

Peak SAR (extrapolated) = 2.07 W/kg

**SAR(1 g) = 1.01 W/kg; SAR(10 g) = 0.499 W/kg** Maximum value of SAR (measured) = 1.12 W/kg

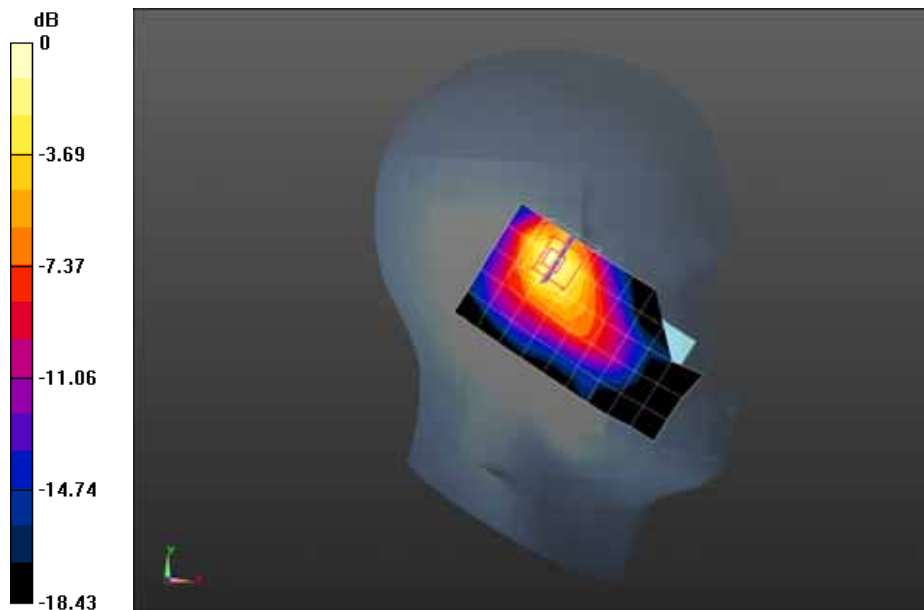

0 dB = 1.12 W/kg = 0.49 dBW/kg

Date/Time: 09-09-2014

Test Laboratory: QuieTek Lab

PCS1900 Low Tilt-Left

**DUT: Mobile Phone; Type: F1010**

Communication System: UID 0, Generic GSM (0); Communication System Band: PCS1900; Duty Cycle: 1:8.3; Frequency: 1850.2 MHz; Medium parameters used:  $f = 1850.2$  MHz;  $\sigma = 1.41$  S/m;  $\epsilon_r = 38.94$ ;  $\rho = 1000$  kg/m<sup>3</sup> ; Phantom section: Left Section

Ambient temperature (°C): 21.5, Liquid temperature (°C): 21.0

DASY5 Configuration:

- Probe: EX3DV4 - SN3710; ConvF(7.72, 7.72, 7.72); Calibrated: 04/03/2014;
- Sensor-Surface: 4mm (Mechanical Surface Detection)
- Electronics: DAE4 Sn1220; Calibrated: 22/01/2014
- Phantom: SAM1; Type: SAM; Serial: TP1561
- Measurement SW: DASY52, Version 52.8 (7); SEMCAD X Version 14.6.10 (7164)

**Configuration/PCS1900 Low Tilt-Left/Area Scan (6x10x1):** Measurement grid: dx=15mm, dy=15mm

Maximum value of SAR (measured) = 0.606 W/kg

**Configuration/PCS1900 Low Tilt-Left/Zoom Scan (5x5x7)/Cube 0:** Measurement grid: dx=8mm, dy=8mm, dz=5mm, Reference Value = 15.093 V/m; Power Drift = 0.02 dB

Peak SAR (extrapolated) = 1.25 W/kg

**SAR(1 g) = 0.663 W/kg; SAR(10 g) = 0.337 W/kg** Maximum value of SAR (measured) = 0.739 W/kg

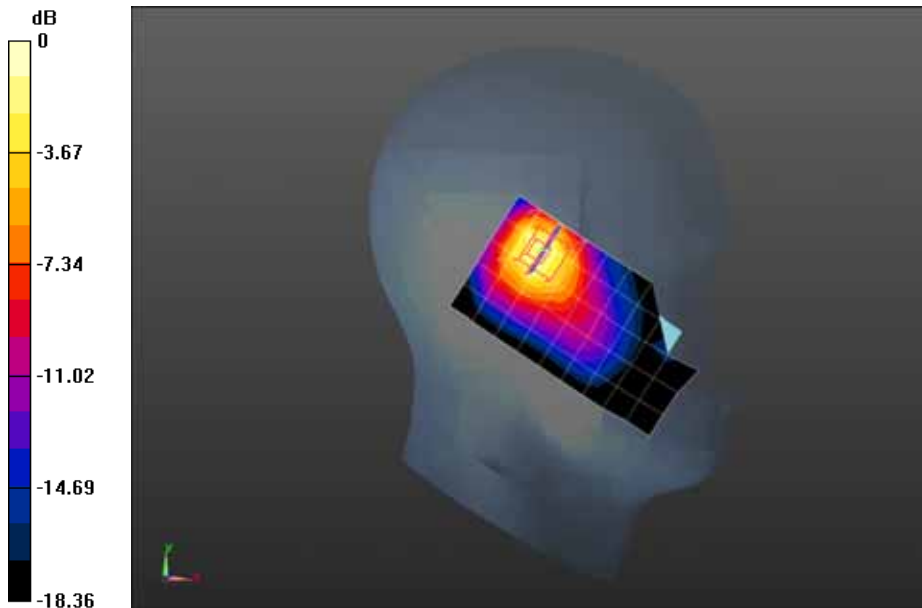

0 dB = 0.739 W/kg = -1.31 dBW/kg

Date/Time: 09-09-2014

Test Laboratory: QuieTek Lab

PCS1900 Mid Tilt-Left

**DUT: Mobile Phone; Type: F1010**

Communication System: UID 0, Generic GSM; Communication System Band: PCS1900; Duty Cycle: 1:8.3; Frequency: 1880 MHz; Medium parameters used:  $f = 1880$  MHz;  $\sigma = 1.42$  S/m;  $\epsilon_r = 38.85$ ;  $\rho = 1000$  kg/m<sup>3</sup>; Phantom section: Left Section

Ambient temperature (°C): 21.5, Liquid temperature (°C): 21.0

DASY5 Configuration:

- Probe: EX3DV4 - SN3710; ConvF(7.72, 7.72, 7.72); Calibrated: 04/03/2014;
- Sensor-Surface: 4mm (Mechanical Surface Detection)
- Electronics: DAE4 Sn1220; Calibrated: 22/01/2014
- Phantom: SAM1; Type: SAM; Serial: TP1561
- Measurement SW: DASY52, Version 52.8 (7); SEMCAD X Version 14.6.10 (7164)

**Configuration/PCS1900 Mid Tilt-Left/Area Scan (6x10x1):** Measurement grid: dx=15mm, dy=15mm

Maximum value of SAR (measured) = 0.722 W/kg

**Configuration/PCS1900 Mid Tilt-Left/Zoom Scan (5x5x7)/Cube 0:** Measurement grid: dx=8mm, dy=8mm, dz=5mm, Reference Value = 15.962 V/m; Power Drift = 0.11 dB

Peak SAR (extrapolated) = 1.54 W/kg

**SAR(1 g) = 0.789 W/kg; SAR(10 g) = 0.396 W/kg** Maximum value of SAR (measured) = 0.885 W/kg

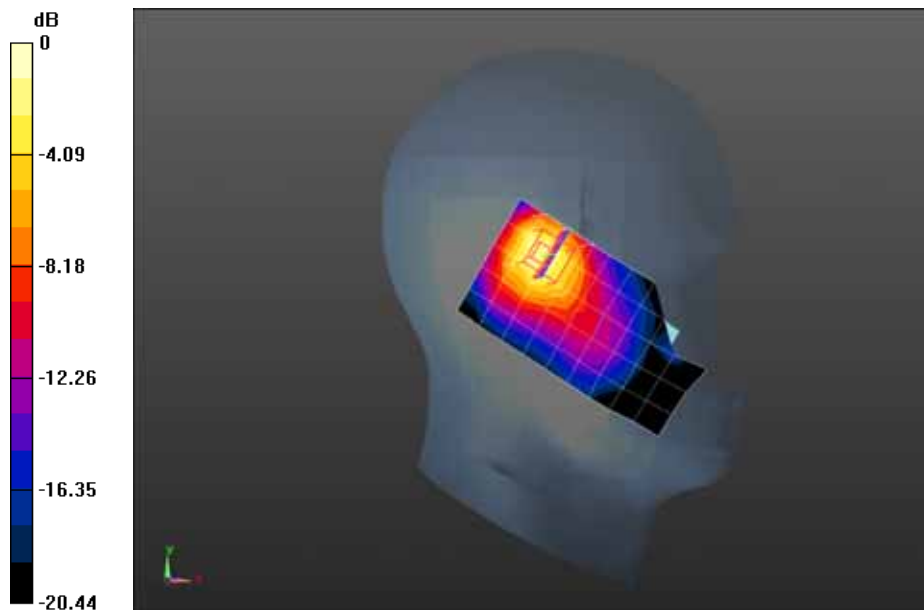

0 dB = 0.885 W/kg = -0.53 dBW/kg

Date/Time: 09-09-2014

Test Laboratory: QuieTek Lab

PCS1900 High Tilt-Left

**DUT: Mobile Phone; Type: F1010**

Communication System: UID 0, Generic GSM (0); Communication System Band: PCS1900; Duty Cycle: 1:8.3; Frequency: 1909.8 MHz; Medium parameters used:  $f = 1909.8$  MHz;  $\sigma = 1.45$  S/m;  $\epsilon_r = 38.7$ ;  $\rho = 1000$  kg/m<sup>3</sup> ; Phantom section: Left Section

Ambient temperature (°C): 21.5, Liquid temperature (°C): 21.0

DASY5 Configuration:

- Probe: EX3DV4 - SN3710; ConvF(7.72, 7.72, 7.72); Calibrated: 04/03/2014;
- Sensor-Surface: 4mm (Mechanical Surface Detection)
- Electronics: DAE4 Sn1220; Calibrated: 22/01/2014
- Phantom: SAM1; Type: SAM; Serial: TP1561
- Measurement SW: DASY52, Version 52.8 (7); SEMCAD X Version 14.6.10 (7164)

**Configuration/PCS1900 High Tilt-Left/Area Scan (6x10x1):** Measurement grid: dx=15mm, dy=15mm

Maximum value of SAR (measured) = 0.801 W/kg

**Configuration/PCS1900 High Tilt-Left/Zoom Scan (5x5x7)/Cube 0:** Measurement grid: dx=8mm, dy=8mm, dz=5mm, Reference Value = 16.263 V/m; Power Drift = 0.09 dB

Peak SAR (extrapolated) = 1.68 W/kg

**SAR(1 g) = 0.870 W/kg; SAR(10 g) = 0.436 W/kg** Maximum value of SAR (measured) = 0.982 W/kg

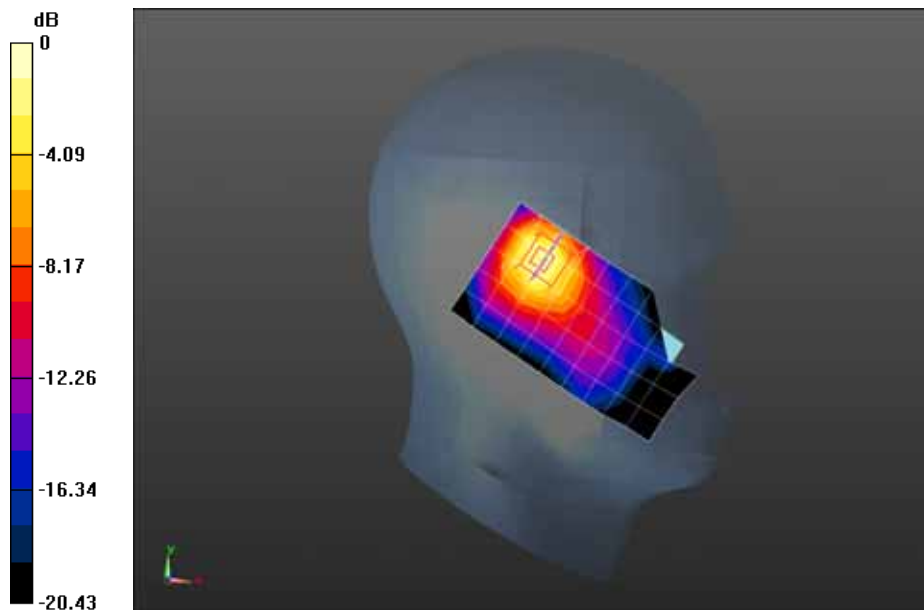

0 dB = 0.982 W/kg = -0.08 dBW/kg



Date/Time: 09-09-2014

Test Laboratory: QuieTek Lab

PCS1900 Mid Touch-Right

**DUT: Mobile Phone; Type: F1010**

Communication System: UID 0, Generic GSM (0); Communication System Band: PCS1900; Duty Cycle: 1:8.3; Frequency: 1880 MHz; Medium parameters used:  $f = 1880$  MHz;  $\sigma = 1.42$  S/m;  $\epsilon_r = 38.85$ ;  $\rho = 1000$  kg/m<sup>3</sup> ; Phantom section: Right Section

Ambient temperature (°C): 21.5, Liquid temperature (°C): 21.0

DASY5 Configuration:

- Probe: EX3DV4 - SN3710; ConvF(7.72, 7.72, 7.72); Calibrated: 04/03/2014;
- Sensor-Surface: 4mm (Mechanical Surface Detection)
- Electronics: DAE4 Sn1220; Calibrated: 22/01/2014
- Phantom: SAM1; Type: SAM; Serial: TP1561
- Measurement SW: DASY52, Version 52.8 (7); SEMCAD X Version 14.6.10 (7164)

**Configuration/PCS1900 Mid Touch-Right/Area Scan (6x10x1):** Measurement grid: dx=15mm, dy=15mm

Maximum value of SAR (measured) = 0.709 W/kg

**Configuration/PCS1900 Mid Touch-Right/Zoom Scan (5x5x7)/Cube 0:** Measurement grid: dx=8mm, dy=8mm, dz=5mm, Reference Value = 17.493 V/m; Power Drift = 0.04 dB

Peak SAR (extrapolated) = 1.21 W/kg

**SAR(1 g) = 0.714 W/kg; SAR(10 g) = 0.400 W/kg** Maximum value of SAR (measured) = 0.791 W/kg

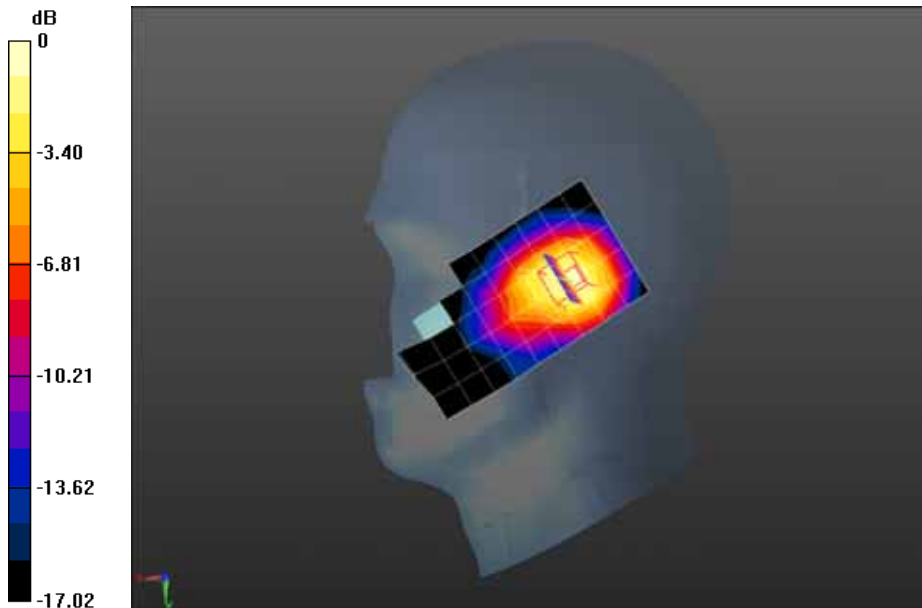

0 dB = 0.791 W/kg = -1.02 dBW/kg

Date/Time: 09-09-2014

Test Laboratory: QuieTek Lab

PCS1900 Mid Tilt-Right

**DUT: Mobile Phone; Type: F1010**

Communication System: UID 0, Generic GSM (0); Communication System Band: PCS1900; Duty Cycle: 1:8.3; Frequency: 1880 MHz; Medium parameters used:  $f = 1880$  MHz;  $\sigma = 1.42$  S/m;  $\epsilon_r = 38.85$ ;  $\rho = 1000$  kg/m<sup>3</sup> ; Phantom section: Right Section

Ambient temperature (°C): 21.5, Liquid temperature (°C): 21.0

DASY5 Configuration:

- Probe: EX3DV4 - SN3710; ConvF(7.72, 7.72, 7.72); Calibrated: 04/03/2014;
- Sensor-Surface: 4mm (Mechanical Surface Detection)
- Electronics: DAE4 Sn1220; Calibrated: 22/01/2014
- Phantom: SAM1; Type: SAM; Serial: TP1561
- Measurement SW: DASY52, Version 52.8 (7); SEMCAD X Version 14.6.10 (7164)

**Configuration/PCS1900 Mid Tilt-Right/Area Scan (6x10x1):** Measurement grid: dx=15mm, dy=15mm

Maximum value of SAR (measured) = 0.457 W/kg

**Configuration/PCS1900 Mid Tilt-Right/Zoom Scan (5x5x7)/Cube 0:** Measurement grid: dx=8mm, dy=8mm, dz=5mm, Reference Value = 15.825 V/m; Power Drift = -0.01 dB

Peak SAR (extrapolated) = 0.772 W/kg

**SAR(1 g) = 0.421 W/kg; SAR(10 g) = 0.228 W/kg** Maximum value of SAR (measured) = 0.464 W/kg

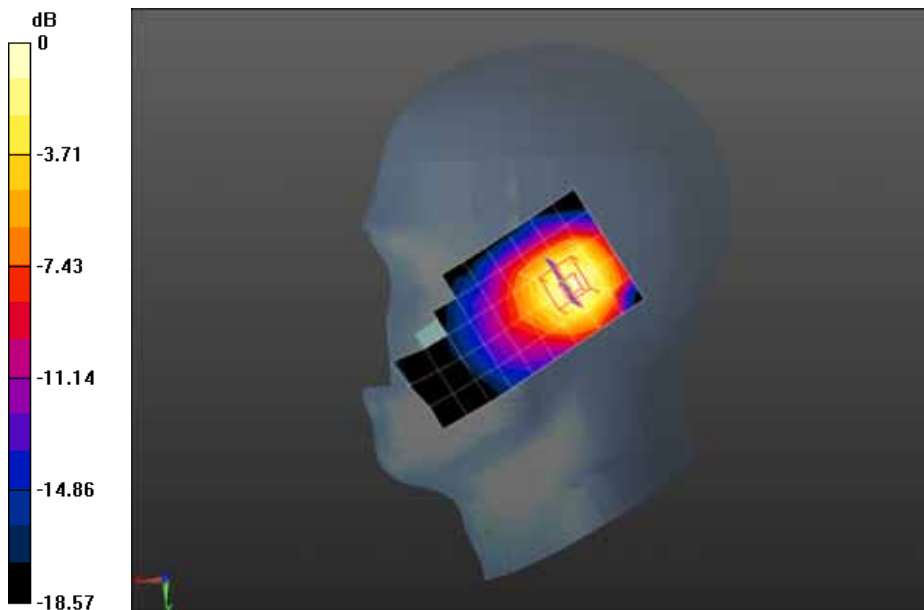

0 dB = 0.464 W/kg = -3.33 dBW/kg

Date/Time: 09-09-2014

Test Laboratory: QuieTek Lab

PCS1900 Mid Body-Back

**DUT: Mobile Phone; Type: F1010**

Communication System: UID 0, Generic GSM; Communication System Band: PCS1900; Duty Cycle: 1:8.3; Frequency: 1880 MHz; Medium parameters used:  $f = 1880 \text{ MHz}$ ;  $\sigma = 1.48 \text{ S/m}$ ;  $\epsilon_r = 52.1$ ;  $\rho = 1000 \text{ kg/m}^3$  ; Phantom section: Flat Section

Ambient temperature (°C): 21.5, Liquid temperature (°C): 21.0

DASY5 Configuration:

- Probe: EX3DV4 - SN3710; ConvF(7.25, 7.25, 7.25); Calibrated: 04/03/2014;
- Sensor-Surface: 4mm (Mechanical Surface Detection)
- Electronics: DAE4 Sn1220; Calibrated: 22/01/2014
- Phantom: SAM1; Type: SAM; Serial: TP1561
- Measurement SW: DASY52, Version 52.8 (7); SEMCAD X Version 14.6.10 (7164)

**Configuration/PCS1900 Mid Body-Back/Area Scan (6x10x1):** Measurement grid: dx=15mm, dy=15mm

Maximum value of SAR (measured) = 0.261 W/kg

**Configuration/PCS1900 Mid Body-Back/Zoom Scan (5x5x7)/Cube 0:** Measurement grid: dx=8mm, dy=8mm, dz=5mm, Reference Value = 11.923 V/m; Power Drift = 0.03 dB

Peak SAR (extrapolated) = 0.463 W/kg

**SAR(1 g) = 0.259 W/kg; SAR(10 g) = 0.142 W/kg** Maximum value of SAR (measured) = 0.281 W/kg

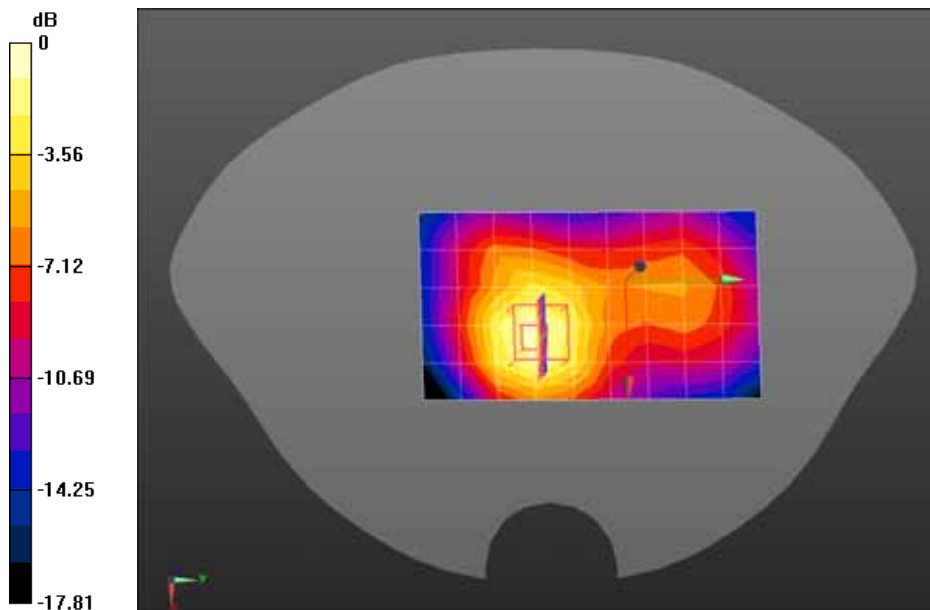

0 dB = 0.281 W/kg = -5.51 dBW/kg

Date/Time: 09-09-2014

Test Laboratory: QuieTek Lab

GPRS1900 Mid Body-Back(2up)

**DUT: Mobile Phone; Type: F1010**

Communication System: UID 0, GPRS/EGPRS-2 Slot (0); Communication System Band: PCS1900; Duty Cycle: 1:4.2 ; Frequency: 1880 MHz; Medium parameters used:  $f = 1880$  MHz;  $\sigma = 1.48$  S/m;  $\epsilon_r = 52.1$ ;  $\rho = 1000$  kg/m<sup>3</sup> ; Phantom section: Flat Section

Ambient temperature (°C): 21.5, Liquid temperature (°C): 21.0

DASY5 Configuration:

- Probe: EX3DV4 - SN3710; ConvF(7.25, 7.25, 7.25); Calibrated: 04/03/2014;
- Sensor-Surface: 4mm (Mechanical Surface Detection)
- Electronics: DAE4 Sn1220; Calibrated: 22/01/2014
- Phantom: SAM1; Type: SAM; Serial: TP1561
- Measurement SW: DASY52, Version 52.8 (7); SEMCAD X Version 14.6.10 (7164)

**Configuration/GPRS1900 Mid Body-Back/Area Scan (6x10x1):** Measurement grid: dx=15mm, dy=15mm

Maximum value of SAR (measured) = 0.380 W/kg

**Configuration/GPRS1900 Mid Body-Back/Zoom Scan (5x5x7)/Cube 0:** Measurement grid: dx=8mm, dy=8mm, dz=5mm, Reference Value = 14.477 V/m; Power Drift = -0.14 dB

Peak SAR (extrapolated) = 0.674 W/kg

**SAR(1 g) = 0.369 W/kg; SAR(10 g) = 0.201 W/kg** Maximum value of SAR (measured) = 0.402 W/kg

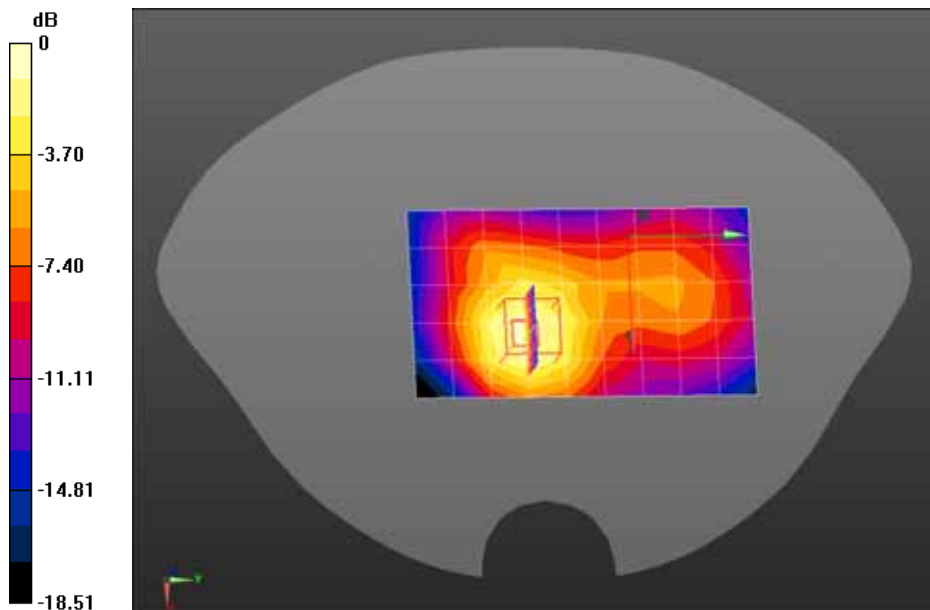

0 dB = 0.402 W/kg = -3.96 dBW/kg

Date/Time: 09-09-2014

Test Laboratory: QuieTek Lab

GPRS1900 Mid Body-Front(2up)

**DUT: Mobile Phone; Type: F1010**

Communication System: UID 0, GPRS/EGPRS-2 Slot (0); Communication System Band: PCS1900; Duty Cycle: 1:4.2 ; Frequency: 1880 MHz; Medium parameters used:  $f = 1880$  MHz;  $\sigma = 1.48$  S/m;  $\epsilon_r = 52.1$ ;  $\rho = 1000$  kg/m<sup>3</sup> ; Phantom section: Flat Section

Ambient temperature (°C): 21.5, Liquid temperature (°C): 21.0

DASY5 Configuration:

- Probe: EX3DV4 - SN3710; ConvF(7.25, 7.25, 7.25); Calibrated: 04/03/2014;
- Sensor-Surface: 4mm (Mechanical Surface Detection)
- Electronics: DAE4 Sn1220; Calibrated: 22/01/2014
- Phantom: SAM1; Type: SAM; Serial: TP1561
- Measurement SW: DASY52, Version 52.8 (7); SEMCAD X Version 14.6.10 (7164)

**Configuration/GPRS1900 Mid Body-Front/Area Scan (6x10x1):** Measurement grid: dx=15mm, dy=15mm

Maximum value of SAR (measured) = 0.193 W/kg

**Configuration/GPRS1900 Mid Body-Front/Zoom Scan (5x5x7)/Cube 0:** Measurement grid: dx=8mm, dy=8mm, dz=5mm, Reference Value = 11.391 V/m; Power Drift = 0.00 dB

Peak SAR (extrapolated) = 0.317 W/kg

**SAR(1 g) = 0.184 W/kg; SAR(10 g) = 0.109 W/kg** Maximum value of SAR (measured) = 0.198 W/kg

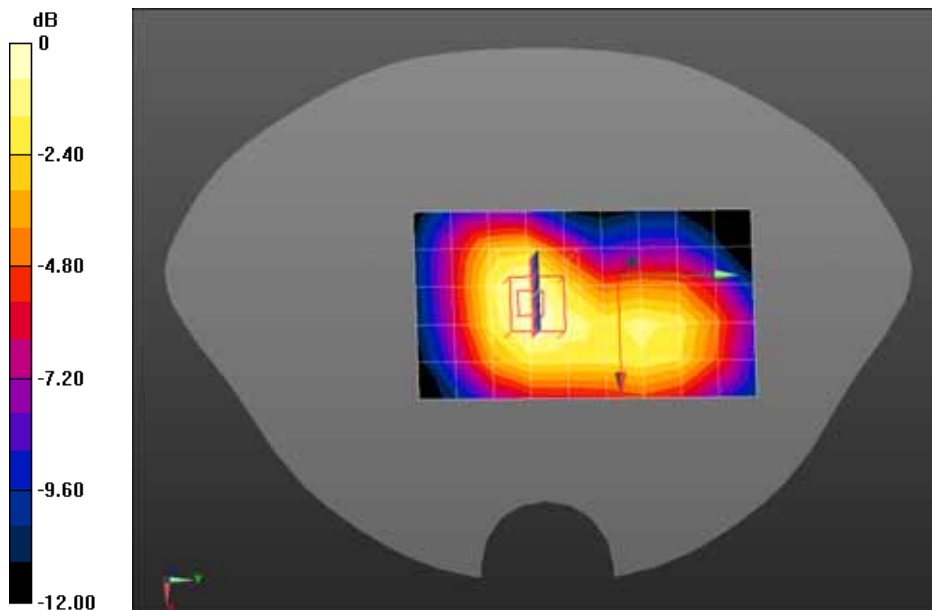

0 dB = 0.198 W/kg = -7.03 dBW/kg

**Appendix C. Test Setup Photographs & EUT Photographs**

**Test Setup Photographs**

Left Head (EUT Cheek)

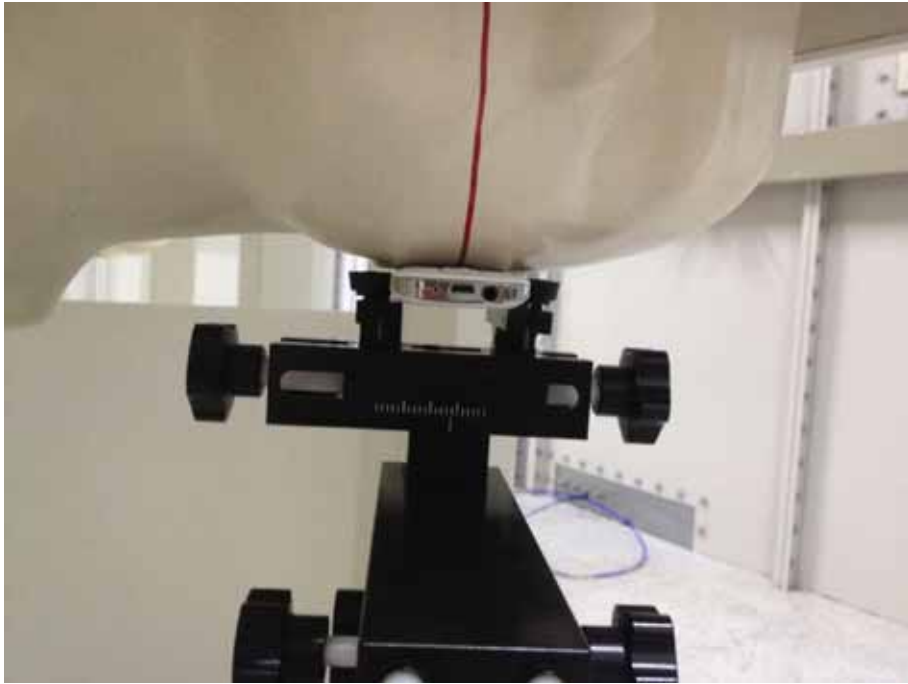

Left Head (EUT Tilted)

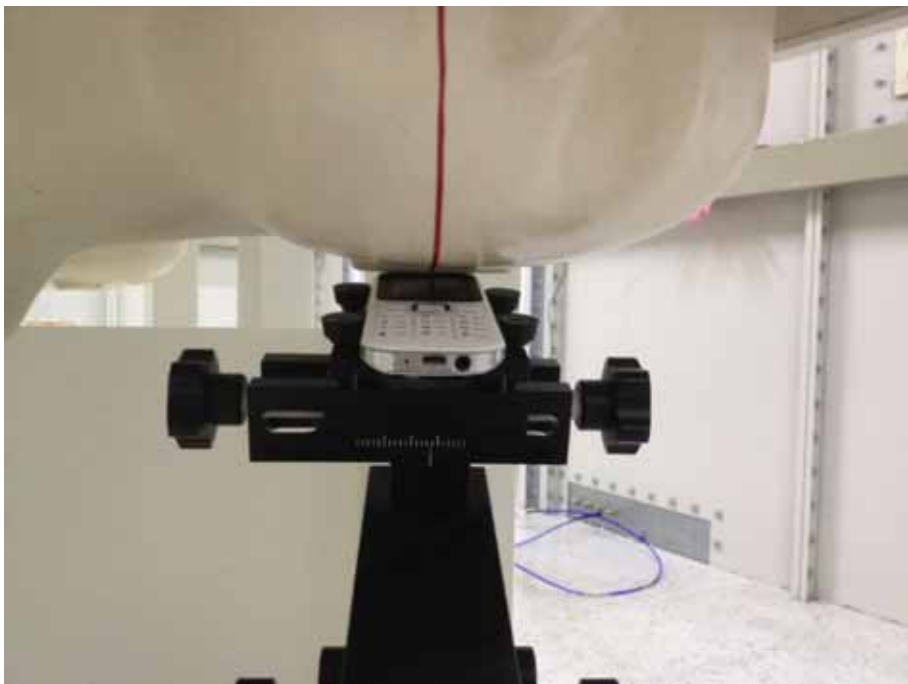

Right Head (EUT Cheek)

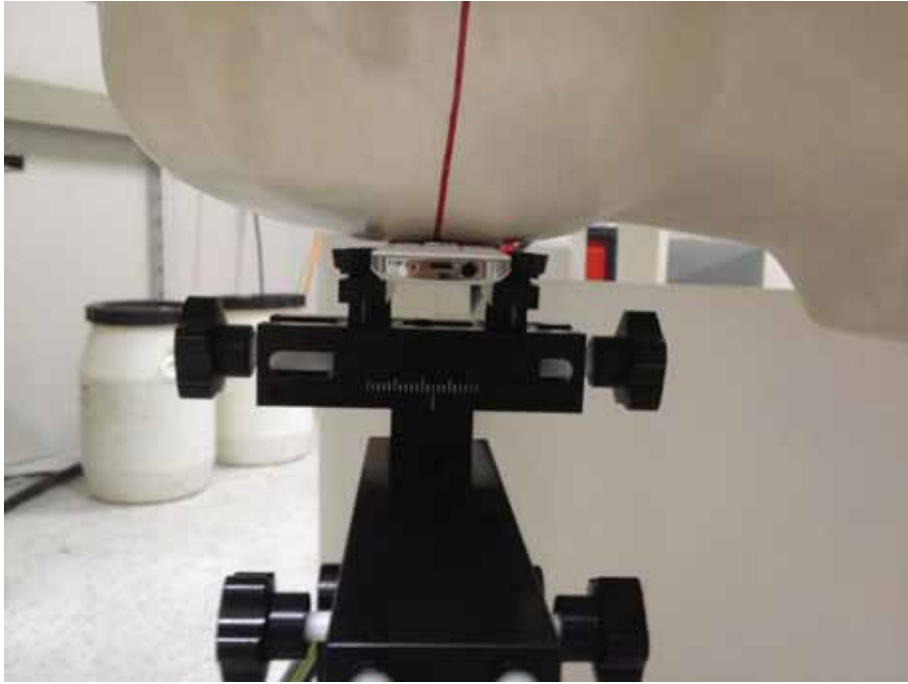

Right Head (EUT Tilted)





Body SAR Back 15mm



Body SAR Front 15mm



**Depth of the liquid in the phantom – Zoom in**

Note: The position used in the measurements were according to IEEE 1528 - 2003

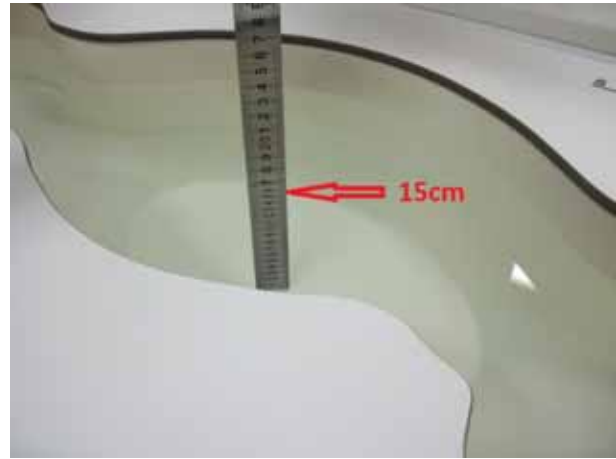
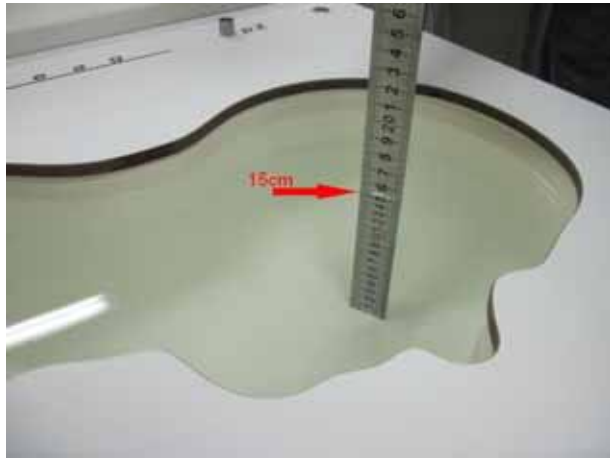

EUT Photographs

(1) EUT Photo



(2) EUT Photo



(3) EUT Photo

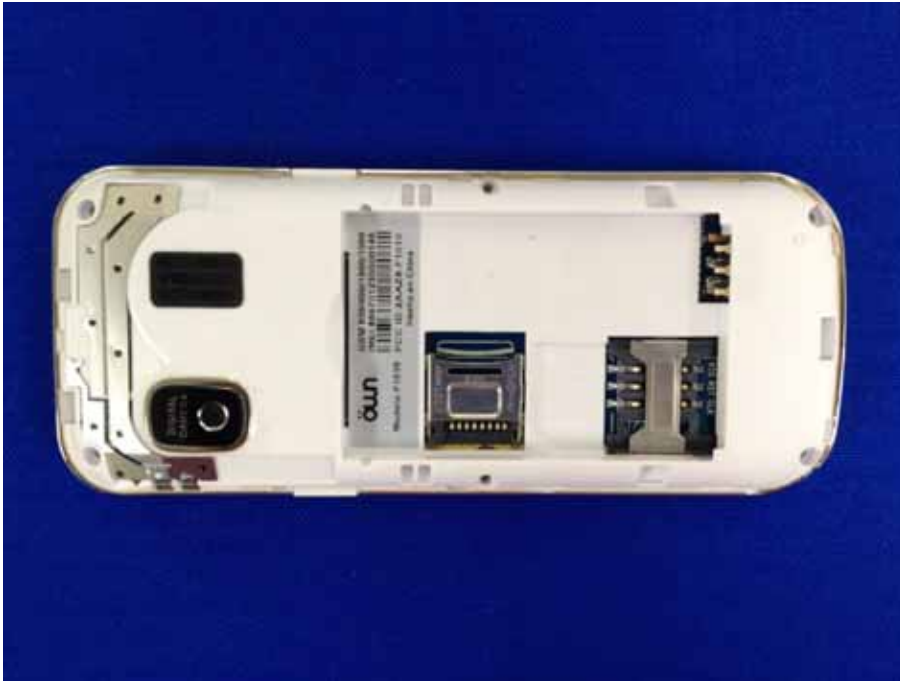

(4) EUT Photo



(5) EUT Photo

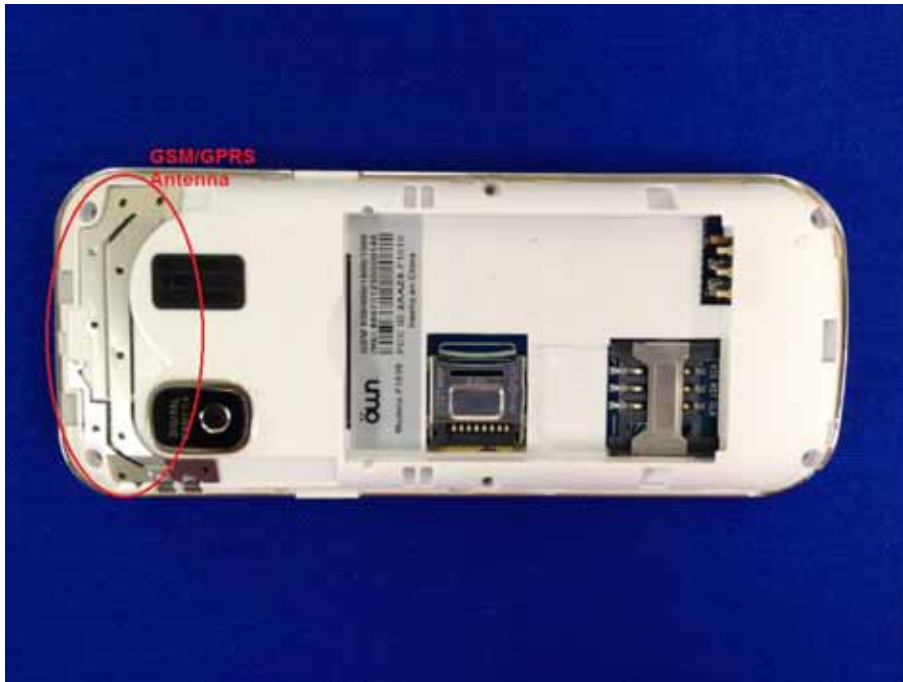

(6) EUT Photo



## Appendix D. Probe Calibration Data

**Calibration Laboratory of  
Schmid & Partner  
Engineering AG**  
Zeughausstrasse 43, 8004 Zurich, Switzerland



**S** Schweizerischer Kalibrierdienst  
**C** Service suisse d'étalonnage  
**S** Servizio svizzero di taratura  
Swiss Calibration Service

Accredited by the Swiss Accreditation Service (SAS)  
The Swiss Accreditation Service is one of the signatories to the EA  
Multilateral Agreement for the recognition of calibration certificates

Accreditation No.: **SCS 108**

Client **Quietek (Auden)**

Certificate No: **EX3-3710\_Mar14**

### CALIBRATION CERTIFICATE

Object	EX3DV4 - SN:3710
Calibration procedure(s)	QA CAL-01.v9, QA CAL-12.v9, QA CAL-14.v4, QA CAL-23.v5, QA CAL-25.v6 Calibration procedure for dosimetric E-field probes
Calibration date:	March 4, 2014
<p>This calibration certificate documents the traceability to national standards, which realize the physical units of measurements (SI). The measurements and the uncertainties with confidence probability are given on the following pages and are part of the certificate.</p> <p>All calibrations have been conducted in the closed laboratory facility: environment temperature (22 ± 3)°C and humidity &lt; 70%.</p> <p>Calibration Equipment used (M&amp;TE critical for calibration)</p>	

Primary Standards	ID	Cal Date (Certificate No.)	Scheduled Calibration
Power meter E4419B	GB41293874	04-Apr-13 (No. 217-01733)	Apr-14
Power sensor E4412A	MY41498087	04-Apr-13 (No. 217-01733)	Apr-14
Reference 3 dB Attenuator	SN: S5054 (3c)	04-Apr-13 (No. 217-01737)	Apr-14
Reference 20 dB Attenuator	SN: S5277 (20x)	04-Apr-13 (No. 217-01735)	Apr-14
Reference 30 dB Attenuator	SN: S5129 (30b)	04-Apr-13 (No. 217-01738)	Apr-14
Reference Probe ES3DV2	SN: 3013	30-Dec-13 (No. ES3-3013_Dec13)	Dec-14
DAE4	SN: 660	13-Dec-13 (No. DAE4-660_Dec13)	Dec-14
Secondary Standards	ID	Check Date (in house)	Scheduled Check
RF generator HP 8648C	US3642U01700	4-Aug-99 (in house check Apr-13)	In house check: Apr-16
Network Analyzer HP 8753E	US37390585	18-Oct-01 (in house check Oct-13)	In house check: Oct-14

Calibrated by:	Name Jeton Kastrati	Function Laboratory Technician	Signature 
Approved by:	Name Katja Pokovic	Function Technical Manager	Signature 
			Issued: March 4, 2014
This calibration certificate shall not be reproduced except in full without written approval of the laboratory.			

**Calibration Laboratory of  
Schmid & Partner  
Engineering AG**  
Zeughausstrasse 43, 8004 Zurich, Switzerland



**S** Schweizerischer Kalibrierdienst  
**S** Service suisse d'étalonnage  
**S** Servizio svizzero di taratura  
**S** Swiss Calibration Service

Accredited by the Swiss Accreditation Service (SAS)  
The Swiss Accreditation Service is one of the signatories to the EA  
Multilateral Agreement for the recognition of calibration certificates

Accreditation No.: **SCS 108**

**Glossary:**

TSL	tissue simulating liquid
NORM <sub>x,y,z</sub>	sensitivity in free space
ConvF	sensitivity in TSL / NORM <sub>x,y,z</sub>
DCP	diode compression point
CF	crest factor (1/duty_cycle) of the RF signal
A, B, C, D	modulation dependent linearization parameters
Polarization $\varphi$	$\varphi$ rotation around probe axis
Polarization $\vartheta$	$\vartheta$ rotation around an axis that is in the plane normal to probe axis (at measurement center), i.e., $\vartheta = 0$ is normal to probe axis
Connector Angle	information used in DASY system to align probe sensor X to the robot coordinate system

**Calibration is Performed According to the Following Standards:**

- a) IEEE Std 1528-2013, "IEEE Recommended Practice for Determining the Peak Spatial-Averaged Specific Absorption Rate (SAR) in the Human Head from Wireless Communications Devices: Measurement Techniques", June 2013
- b) IEC 62209-1, "Procedure to measure the Specific Absorption Rate (SAR) for hand-held devices used in close proximity to the ear (frequency range of 300 MHz to 3 GHz)", February 2005

**Methods Applied and Interpretation of Parameters:**

- **NORM<sub>x,y,z</sub>:** Assessed for E-field polarization  $\vartheta = 0$  ( $f \leq 900$  MHz in TEM-cell;  $f > 1800$  MHz: R22 waveguide). NORM<sub>x,y,z</sub> are only intermediate values, i.e., the uncertainties of NORM<sub>x,y,z</sub> does not affect the E<sup>2</sup>-field uncertainty inside TSL (see below ConvF).
- **NORM(f)<sub>x,y,z</sub> = NORM<sub>x,y,z</sub> \* frequency\_response** (see Frequency Response Chart). This linearization is implemented in DASY4 software versions later than 4.2. The uncertainty of the frequency response is included in the stated uncertainty of ConvF.
- **DCP<sub>x,y,z</sub>:** DCP are numerical linearization parameters assessed based on the data of power sweep with CW signal (no uncertainty required). DCP does not depend on frequency nor media.
- **PAR:** PAR is the Peak to Average Ratio that is not calibrated but determined based on the signal characteristics
- **A<sub>x,y,z</sub>; B<sub>x,y,z</sub>; C<sub>x,y,z</sub>; D<sub>x,y,z</sub>; VR<sub>x,y,z</sub>:** A, B, C, D are numerical linearization parameters assessed based on the data of power sweep for specific modulation signal. The parameters do not depend on frequency nor media. VR is the maximum calibration range expressed in RMS voltage across the diode.
- **ConvF and Boundary Effect Parameters:** Assessed in flat phantom using E-field (or Temperature Transfer Standard for  $f \leq 800$  MHz) and inside waveguide using analytical field distributions based on power measurements for  $f > 800$  MHz. The same setups are used for assessment of the parameters applied for boundary compensation (alpha, depth) of which typical uncertainty values are given. These parameters are used in DASY4 software to improve probe accuracy close to the boundary. The sensitivity in TSL corresponds to NORM<sub>x,y,z</sub> \* ConvF whereby the uncertainty corresponds to that given for ConvF. A frequency dependent ConvF is used in DASY version 4.4 and higher which allows extending the validity from  $\pm 50$  MHz to  $\pm 100$  MHz.
- **Spherical isotropy (3D deviation from isotropy):** in a field of low gradients realized using a flat phantom exposed by a patch antenna.
- **Sensor Offset:** The sensor offset corresponds to the offset of virtual measurement center from the probe tip (on probe axis). No tolerance required.
- **Connector Angle:** The angle is assessed using the information gained by determining the NORM<sub>x</sub> (no uncertainty required).

EX3DV4 – SN:3710

March 4, 2014

# Probe EX3DV4

## SN:3710

Manufactured: July 21, 2009  
Calibrated: March 4, 2014

Calibrated for DASY/EASY Systems  
(Note: non-compatible with DASY2 system!)

EX3DV4- SN:3710

March 4, 2014

## DASY/EASY - Parameters of Probe: EX3DV4 - SN:3710

### Basic Calibration Parameters

	Sensor X	Sensor Y	Sensor Z	Unc (k=2)
Norm ( $\mu\text{V}/(\text{V}/\text{m})^2$ ) <sup>A</sup>	0.51	0.56	0.44	± 10.1 %
DCP (mV) <sup>B</sup>	100.3	97.6	101.3	

### Modulation Calibration Parameters

UID	Communication System Name		A dB	B dB $\sqrt{\mu\text{V}}$	C	D dB	VR mV	Unc <sup>E</sup> (k=2)
0	CW	X	0.0	0.0	1.0	0.00	137.9	±3.5 %
		Y	0.0	0.0	1.0		136.7	
		Z	0.0	0.0	1.0		139.8	

The reported uncertainty of measurement is stated as the standard uncertainty of measurement multiplied by the coverage factor k=2, which for a normal distribution corresponds to a coverage probability of approximately 95%.

<sup>A</sup> The uncertainties of NormX,Y,Z do not affect the E<sup>2</sup>-field uncertainty inside TSL (see Pages 5 and 6).

<sup>B</sup> Numerical linearization parameter: uncertainty not required.

<sup>E</sup> Uncertainty is determined using the max. deviation from linear response applying rectangular distribution and is expressed for the square of the field value.



EX3DV4- SN:3710

March 4, 2014

**DASY/EASY - Parameters of Probe: EX3DV4 - SN:3710**

**Calibration Parameter Determined in Head Tissue Simulating Media**

f (MHz) <sup>C</sup>	Relative Permittivity <sup>F</sup>	Conductivity (S/m) <sup>F</sup>	ConvF X	ConvF Y	ConvF Z	Alpha <sup>G</sup>	Depth <sup>G</sup> (mm)	Unct. (k=2)
450	43.5	0.87	10.42	10.42	10.42	0.17	2.22	± 13.3 %
750	41.9	0.89	9.76	9.76	9.76	0.62	0.69	± 12.0 %
835	41.5	0.90	9.56	9.56	9.56	0.57	0.69	± 12.0 %
900	41.5	0.97	9.42	9.42	9.42	0.53	0.72	± 12.0 %
1810	40.0	1.40	7.74	7.74	7.74	0.41	0.94	± 12.0 %
1900	40.0	1.40	7.72	7.72	7.72	0.49	0.85	± 12.0 %
2450	39.2	1.80	7.04	7.04	7.04	0.39	1.03	± 12.0 %
2600	39.0	1.96	6.87	6.87	6.87	0.60	0.80	± 12.0 %
3500	37.9	2.91	6.82	6.82	6.82	0.55	0.88	± 13.1 %
5200	36.0	4.66	4.91	4.91	4.91	0.40	1.80	± 13.1 %
5500	35.6	4.96	4.63	4.63	4.63	0.40	1.80	± 13.1 %
5800	35.3	5.27	4.43	4.43	4.43	0.40	1.80	± 13.1 %

<sup>C</sup> Frequency validity of ± 100 MHz only applies for DASY v4.4 and higher (see Page 2), else it is restricted to ± 50 MHz. The uncertainty is the RSS of the ConvF uncertainty at calibration frequency and the uncertainty for the indicated frequency band.

<sup>F</sup> At frequencies below 3 GHz, the validity of tissue parameters ( $\epsilon$  and  $\sigma$ ) can be relaxed to ± 10% if liquid compensation formula is applied to measured SAR values. At frequencies above 3 GHz, the validity of tissue parameters ( $\epsilon$  and  $\sigma$ ) is restricted to ± 5%. The uncertainty is the RSS of the ConvF uncertainty for indicated target tissue parameters.

<sup>G</sup> Alpha/Depth are determined during calibration. SPEAG warrants that the remaining deviation due to the boundary effect after compensation is always less than ± 1% for frequencies below 3 GHz and below ± 2% for frequencies between 3-6 GHz at any distance larger than half the probe tip diameter from the boundary.

EX3DV4- SN:3710

March 4, 2014

## DASY/EASY - Parameters of Probe: EX3DV4 - SN:3710

### Calibration Parameter Determined in Body Tissue Simulating Media

f (MHz) <sup>C</sup>	Relative Permittivity <sup>F</sup>	Conductivity (S/m) <sup>F</sup>	ConvF X	ConvF Y	ConvF Z	Alpha <sup>G</sup>	Depth (mm) <sup>G</sup>	Unct. (k=2)
450	56.7	0.94	10.53	10.53	10.53	0.10	1.00	± 13.3 %
750	55.5	0.96	9.28	9.28	9.28	0.39	0.93	± 12.0 %
835	55.2	0.97	9.22	9.22	9.22	0.65	0.72	± 12.0 %
900	55.0	1.05	9.04	9.04	9.04	0.75	0.67	± 12.0 %
1810	53.3	1.52	7.36	7.36	7.36	0.80	0.62	± 12.0 %
1900	53.3	1.52	7.25	7.25	7.25	0.55	0.76	± 12.0 %
2450	52.7	1.95	6.88	6.88	6.88	0.80	0.58	± 12.0 %
2600	52.5	2.16	6.67	6.67	6.67	0.80	0.50	± 12.0 %
3500	51.3	3.31	6.29	6.29	6.29	0.44	1.02	± 13.1 %
5200	49.0	5.30	4.22	4.22	4.22	0.50	1.90	± 13.1 %
5500	48.6	5.65	3.91	3.91	3.91	0.50	1.90	± 13.1 %
5800	48.2	6.00	4.00	4.00	4.00	0.50	1.90	± 13.1 %

<sup>C</sup> Frequency validity of ± 100 MHz only applies for DASY v4.4 and higher (see Page 2), else it is restricted to ± 50 MHz. The uncertainty is the RSS of the ConvF uncertainty at calibration frequency and the uncertainty for the indicated frequency band.

<sup>F</sup> At frequencies below 3 GHz, the validity of tissue parameters ( $\epsilon$  and  $\sigma$ ) can be relaxed to ± 10% if liquid compensation formula is applied to measured SAR values. At frequencies above 3 GHz, the validity of tissue parameters ( $\epsilon$  and  $\sigma$ ) is restricted to ± 5%. The uncertainty is the RSS of the ConvF uncertainty for indicated target tissue parameters.

<sup>G</sup> Alpha/Depth are determined during calibration. SPEAG warrants that the remaining deviation due to the boundary effect after compensation is always less than ± 1% for frequencies below 3 GHz and below ± 2% for frequencies between 3-6 GHz at any distance larger than half the probe tip diameter from the boundary.

EX3DV4-SN:3710

March 4, 2014

### Frequency Response of E-Field (TEM-Cell: ifi1110 EXX, Waveguide: R22)

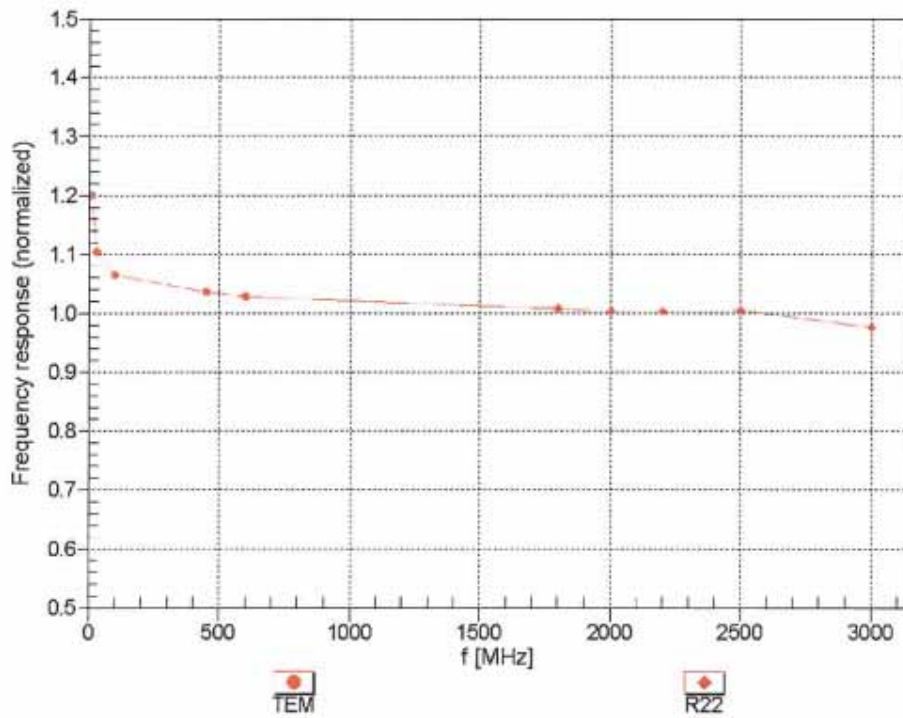

Uncertainty of Frequency Response of E-field:  $\pm 6.3\%$  (k=2)

EX3DV4- SN:3710

March 4, 2014

Receiving Pattern ( $\phi$ ),  $\theta = 0^\circ$

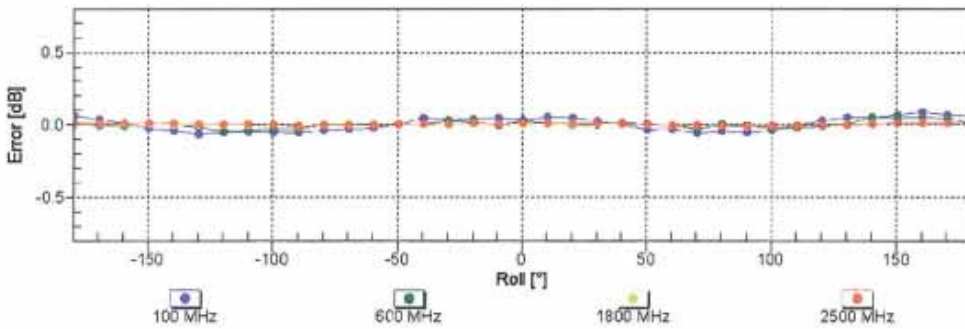
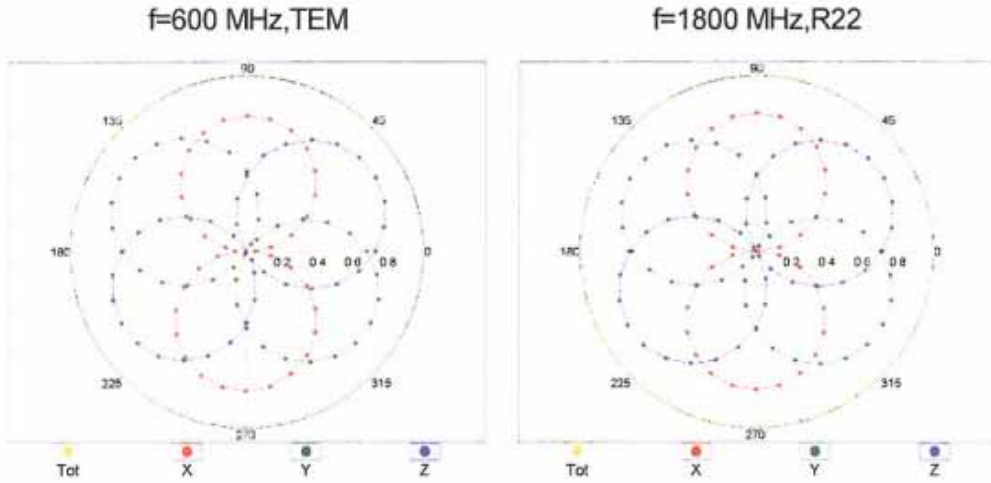

Uncertainty of Axial Isotropy Assessment:  $\pm 0.5\%$  ( $k=2$ )

EX3DV4- SN:3710

March 4, 2014

**Dynamic Range  $f(SAR_{head})$**   
 (TEM cell ,  $f_{eval}=1900$  MHz)

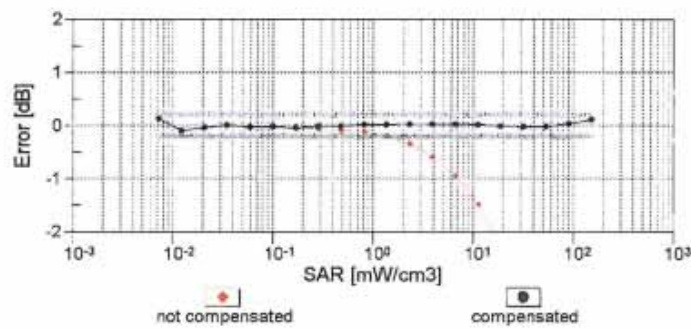
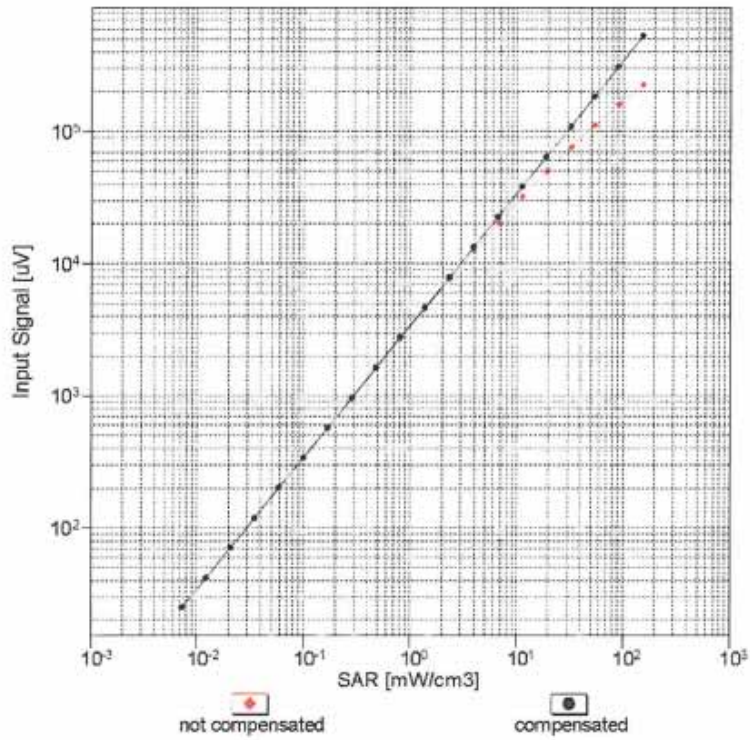

Uncertainty of Linearity Assessment:  $\pm 0.6\%$  ( $k=2$ )

EX3DV4- SN:3710

March 4, 2014

### Conversion Factor Assessment

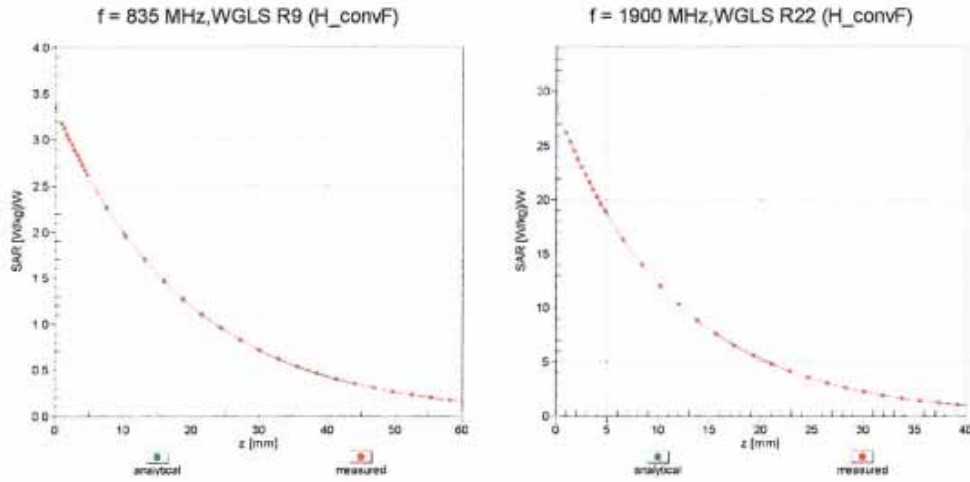

### Deviation from Isotropy in Liquid

Error ( $\phi, \theta$ ),  $f = 900$  MHz

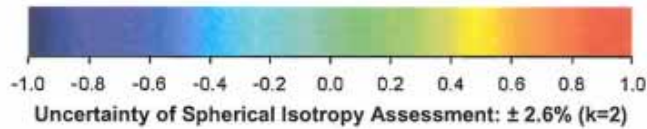
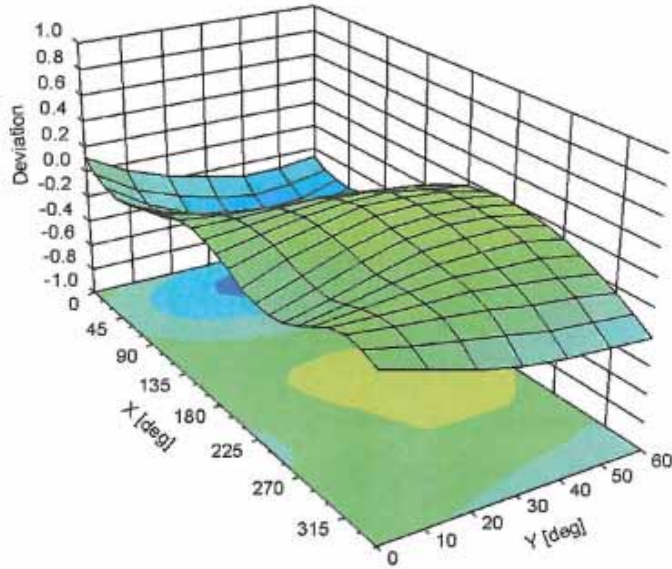

EX3DV4- SN:3710

March 4, 2014

## DASY/EASY - Parameters of Probe: EX3DV4 - SN:3710

### Other Probe Parameters

Sensor Arrangement	Triangular
Connector Angle (°)	-19.6
Mechanical Surface Detection Mode	enabled
Optical Surface Detection Mode	disabled
Probe Overall Length	337 mm
Probe Body Diameter	10 mm
Tip Length	9 mm
Tip Diameter	2.5 mm
Probe Tip to Sensor X Calibration Point	1 mm
Probe Tip to Sensor Y Calibration Point	1 mm
Probe Tip to Sensor Z Calibration Point	1 mm
Recommended Measurement Distance from Surface	2 mm

**Appendix E. Dipole Calibration Data**

**Calibration Laboratory of  
Schmid & Partner  
Engineering AG**  
Zeughausstrasse 43, 8004 Zurich, Switzerland



**S** Schweizerischer Kalibrierdienst  
**C** Service suisse d'étalonnage  
**S** Servizio svizzero di taratura  
**S** Swiss Calibration Service

Accredited by the Swiss Accreditation Service (SAS)  
The Swiss Accreditation Service is one of the signatories to the EA  
Multilateral Agreement for the recognition of calibration certificates

Accreditation No.: **SCS 108**

Client **Quietek-CN (Auden)**

Certificate No: **D835V2-4d094\_Feb14**

**CALIBRATION CERTIFICATE**

Object **D835V2 - SN: 4d094**

Calibration procedure(s) **QA CAL-05.v9  
Calibration procedure for dipole validation kits above 700 MHz**

Calibration date: **February 27, 2014**

This calibration certificate documents the traceability to national standards, which realize the physical units of measurements (SI).  
The measurements and the uncertainties with confidence probability are given on the following pages and are part of the certificate.

All calibrations have been conducted in the closed laboratory facility: environment temperature (22 ± 3)°C and humidity < 70%.

Calibration Equipment used (M&TE critical for calibration)

Primary Standards	ID #	Cal Date (Certificate No.)	Scheduled Calibration
Power meter EPM-442A	GB37480704	09-Oct-13 (No. 217-01827)	Oct-14
Power sensor HP 8481A	US37292783	09-Oct-13 (No. 217-01827)	Oct-14
Power sensor HP 8481A	MY41092317	09-Oct-13 (No. 217-01828)	Oct-14
Reference 20 dB Attenuator	SN: 5058 (20k)	04-Apr-13 (No. 217-01736)	Apr-14
Type-N mismatch combination	SN: 5047.3 / 06327	04-Apr-13 (No. 217-01739)	Apr-14
Reference Probe ES3DV3	SN: 3205	30-Dec-13 (No. ES3-3205_Dec13)	Dec-14
DAE4	SN: 601	25-Apr-13 (No. DAE4-601_Apr13)	Apr-14
Secondary Standards	ID #	Check Date (in house)	Scheduled Check
RF generator R&S SMT-06	100005	04-Aug-99 (in house check Oct-13)	In house check: Oct-16
Network Analyzer HP 8753E	US37390585 S4206	18-Oct-01 (in house check Oct-13)	In house check: Oct-14

	<b>Name</b>	<b>Function</b>	<b>Signature</b>
Calibrated by:	Jeton Kastrati	Laboratory Technician	
Approved by:	Katja Pokovic	Technical Manager	

Issued: February 28, 2014

This calibration certificate shall not be reproduced except in full without written approval of the laboratory.



**Calibration Laboratory of  
Schmid & Partner  
Engineering AG**  
Zeughausstrasse 43, 8004 Zurich, Switzerland



**S** Schweizerischer Kalibrierdienst  
**C** Service suisse d'étalonnage  
**S** Servizio svizzero di taratura  
**S** Swiss Calibration Service

Accredited by the Swiss Accreditation Service (SAS)  
The Swiss Accreditation Service is one of the signatories to the EA  
Multilateral Agreement for the recognition of calibration certificates

Accreditation No.: **SCS 108**

**Glossary:**

TSL	tissue simulating liquid
ConvF	sensitivity in TSL / NORM x,y,z
N/A	not applicable or not measured

**Calibration is Performed According to the Following Standards:**

- a) IEEE Std 1528-2013, "IEEE Recommended Practice for Determining the Peak Spatial-Averaged Specific Absorption Rate (SAR) in the Human Head from Wireless Communications Devices: Measurement Techniques", June 2013
- b) IEC 62209-1, "Procedure to measure the Specific Absorption Rate (SAR) for hand-held devices used in close proximity to the ear (frequency range of 300 MHz to 3 GHz)", February 2005
- c) KDB 865664, "SAR Measurement Requirements for 100 MHz to 6 GHz"

**Additional Documentation:**

- d) DASy4/5 System Handbook

**Methods Applied and Interpretation of Parameters:**

- *Measurement Conditions:* Further details are available from the Validation Report at the end of the certificate. All figures stated in the certificate are valid at the frequency indicated.
- *Antenna Parameters with TSL:* The dipole is mounted with the spacer to position its feed point exactly below the center marking of the flat phantom section, with the arms oriented parallel to the body axis.
- *Feed Point Impedance and Return Loss:* These parameters are measured with the dipole positioned under the liquid filled phantom. The impedance stated is transformed from the measurement at the SMA connector to the feed point. The Return Loss ensures low reflected power. No uncertainty required.
- *Electrical Delay:* One-way delay between the SMA connector and the antenna feed point. No uncertainty required.
- *SAR measured:* SAR measured at the stated antenna input power.
- *SAR normalized:* SAR as measured, normalized to an input power of 1 W at the antenna connector.
- *SAR for nominal TSL parameters:* The measured TSL parameters are used to calculate the nominal SAR result.

The reported uncertainty of measurement is stated as the standard uncertainty of measurement multiplied by the coverage factor  $k=2$ , which for a normal distribution corresponds to a coverage probability of approximately 95%.

**Measurement Conditions**

DASY system configuration, as far as not given on page 1.

DASY Version	DASY5	V52.8.7
Extrapolation	Advanced Extrapolation	
Phantom	Modular Flat Phantom	
Distance Dipole Center - TSL	15 mm	with Spacer
Zoom Scan Resolution	dx, dy, dz = 5 mm	
Frequency	835 MHz ± 1 MHz	

**Head TSL parameters**

The following parameters and calculations were applied.

	Temperature	Permittivity	Conductivity
Nominal Head TSL parameters	22.0 °C	41.5	0.90 mho/m
Measured Head TSL parameters	(22.0 ± 0.2) °C	40.5 ± 6 %	0.93 mho/m ± 6 %
Head TSL temperature change during test	< 0.5 °C	----	----

**SAR result with Head TSL**

SAR averaged over 1 cm <sup>3</sup> (1 g) of Head TSL	Condition	
SAR measured	250 mW input power	2.47 W/kg
SAR for nominal Head TSL parameters	normalized to 1W	<b>9.59 W/kg ± 17.0 % (k=2)</b>

SAR averaged over 10 cm <sup>3</sup> (10 g) of Head TSL	condition	
SAR measured	250 mW input power	1.59 W/kg
SAR for nominal Head TSL parameters	normalized to 1W	<b>6.21 W/kg ± 16.5 % (k=2)</b>

**Body TSL parameters**

The following parameters and calculations were applied.

	Temperature	Permittivity	Conductivity
Nominal Body TSL parameters	22.0 °C	55.2	0.97 mho/m
Measured Body TSL parameters	(22.0 ± 0.2) °C	54.0 ± 6 %	1.00 mho/m ± 6 %
Body TSL temperature change during test	< 0.5 °C	----	----

**SAR result with Body TSL**

SAR averaged over 1 cm <sup>3</sup> (1 g) of Body TSL	Condition	
SAR measured	250 mW input power	2.42 W/kg
SAR for nominal Body TSL parameters	normalized to 1W	<b>9.42 W/kg ± 17.0 % (k=2)</b>

SAR averaged over 10 cm <sup>3</sup> (10 g) of Body TSL	condition	
SAR measured	250 mW input power	1.57 W/kg
SAR for nominal Body TSL parameters	normalized to 1W	<b>6.15 W/kg ± 16.5 % (k=2)</b>

**Appendix**

**Antenna Parameters with Head TSL**

Impedance, transformed to feed point	51.4 $\Omega$ - 2.8 j $\Omega$
Return Loss	- 30.2 dB

**Antenna Parameters with Body TSL**

Impedance, transformed to feed point	46.9 $\Omega$ - 5.0 j $\Omega$
Return Loss	- 24.3 dB

**General Antenna Parameters and Design**

Electrical Delay (one direction)	1.386 ns
----------------------------------	----------

After long term use with 100W radiated power, only a slight warming of the dipole near the feedpoint can be measured.

The dipole is made of standard semirigid coaxial cable. The center conductor of the feeding line is directly connected to the second arm of the dipole. The antenna is therefore short-circuited for DC-signals. On some of the dipoles, small end caps are added to the dipole arms in order to improve matching when loaded according to the position as explained in the "Measurement Conditions" paragraph. The SAR data are not affected by this change. The overall dipole length is still according to the Standard.

No excessive force must be applied to the dipole arms, because they might bend or the soldered connections near the feedpoint may be damaged.

**Additional EUT Data**

Manufactured by	SPEAG
Manufactured on	September 15, 2009

## DASY5 Validation Report for Head TSL

Date: 27.02.2014

Test Laboratory: SPEAG, Zurich, Switzerland

**DUT: Dipole 835 MHz; Type: D835V2; Serial: D835V2 - SN: 4d094**

Communication System: UID 0 - CW; Frequency: 835 MHz

Medium parameters used:  $f = 835$  MHz;  $\sigma = 0.93$  S/m;  $\epsilon_r = 40.5$ ;  $\rho = 1000$  kg/m<sup>3</sup>

Phantom section: Flat Section

Measurement Standard: DASY5 (IEEE/IEC/ANSI C63.19-2007)

DASY52 Configuration:

- Probe: ES3DV3 - SN3205; ConvF(6.22, 6.22, 6.22); Calibrated: 30.12.2013;
- Sensor-Surface: 3mm (Mechanical Surface Detection)
- Electronics: DAE4 Sn601; Calibrated: 25.04.2013
- Phantom: Flat Phantom 4.9L; Type: QD000P49AA; Serial: 1001
- DASY52 52.8.7(1137); SEMCAD X 14.6.10(7164)

### Dipole Calibration for Head Tissue/Pin=250 mW, d=15mm/Zoom Scan (7x7x7)/Cube 0:

Measurement grid: dx=5mm, dy=5mm, dz=5mm

Reference Value = 59.179 V/m; Power Drift = -0.01 dB

Peak SAR (extrapolated) = 3.80 W/kg

**SAR(1 g) = 2.47 W/kg; SAR(10 g) = 1.59 W/kg**

Maximum value of SAR (measured) = 2.91 W/kg

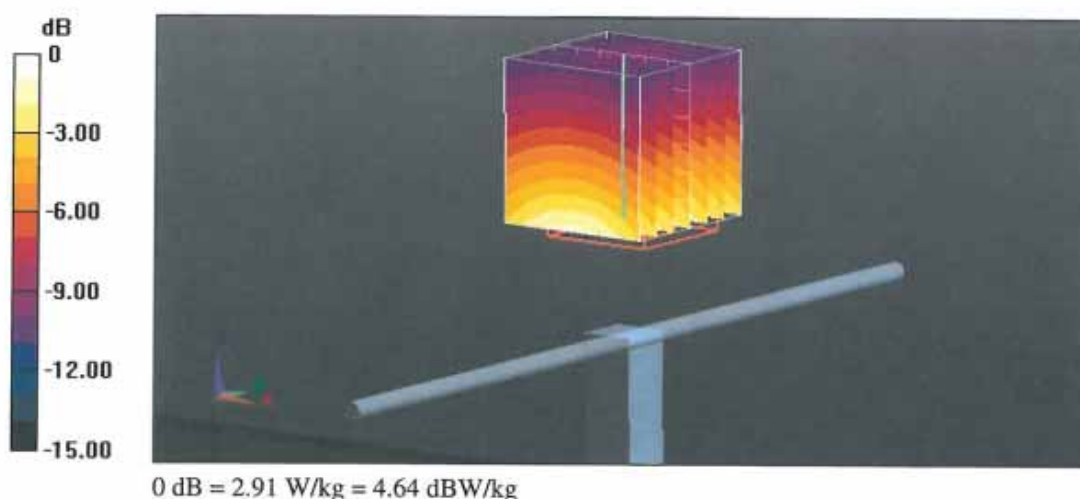

Impedance Measurement Plot for Head TSL

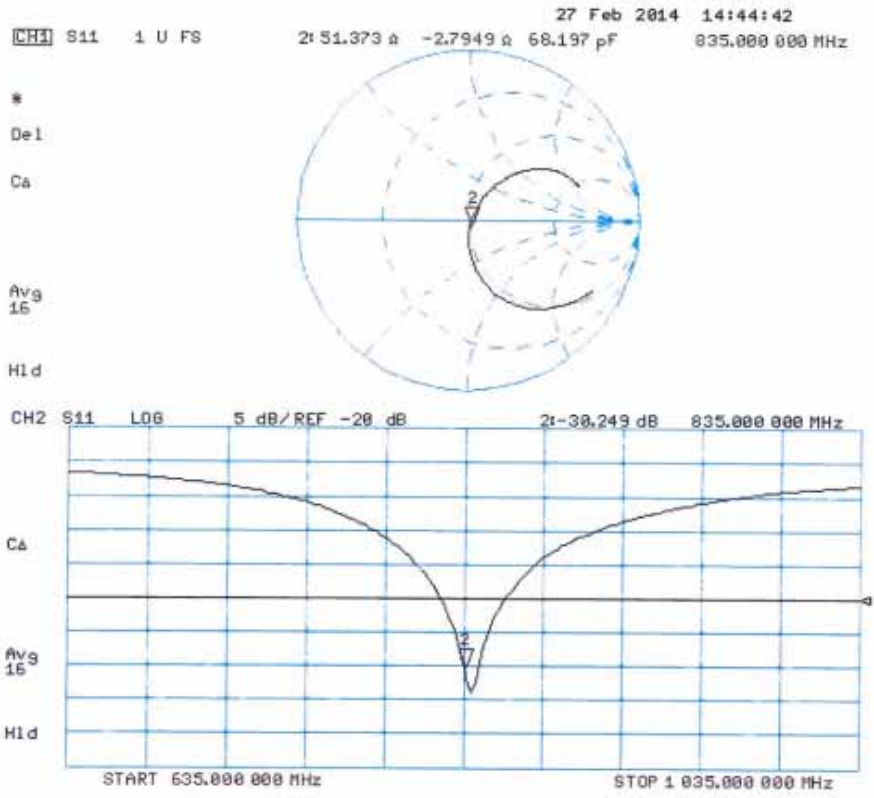

## DASY5 Validation Report for Body TSL

Date: 27.02.2014

Test Laboratory: SPEAG, Zurich, Switzerland

**DUT: Dipole 835 MHz; Type: D835V2; Serial: D835V2 - SN: 4d094**

Communication System: UID 0 - CW; Frequency: 835 MHz

Medium parameters used:  $f = 835$  MHz;  $\sigma = 1$  S/m;  $\epsilon_r = 54$ ;  $\rho = 1000$  kg/m<sup>3</sup>

Phantom section: Flat Section

Measurement Standard: DASY5 (IEEE/IEC/ANSI C63.19-2007)

DASY52 Configuration:

- Probe: ES3DV3 - SN3205; ConvF(6.09, 6.09, 6.09); Calibrated: 30.12.2013;
- Sensor-Surface: 3mm (Mechanical Surface Detection)
- Electronics: DAE4 Sn601; Calibrated: 25.04.2013
- Phantom: Flat Phantom 4.9L; Type: QD000P49AA; Serial: 1001
- DASY52 52.8.7(1137); SEMCAD X 14.6.10(7164)

### Dipole Calibration for Body Tissue/Pin=250 mW, d=15mm/Zoom Scan (7x7x7)/Cube 0:

Measurement grid: dx=5mm, dy=5mm, dz=5mm

Reference Value = 55.012 V/m; Power Drift = 0.01 dB

Peak SAR (extrapolated) = 3.62 W/kg

**SAR(1 g) = 2.42 W/kg; SAR(10 g) = 1.57 W/kg**

Maximum value of SAR (measured) = 2.82 W/kg

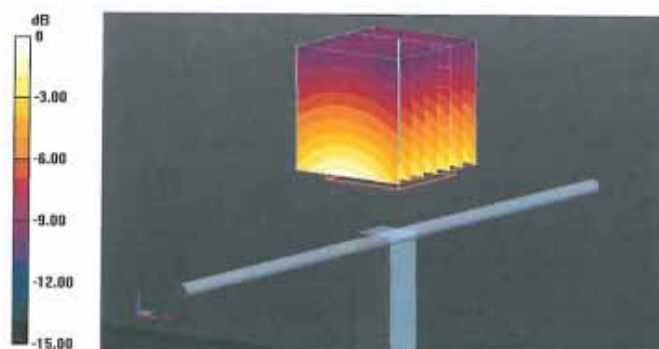

0 dB = 2.82 W/kg = 4.50 dBW/kg

Impedance Measurement Plot for Body TSL

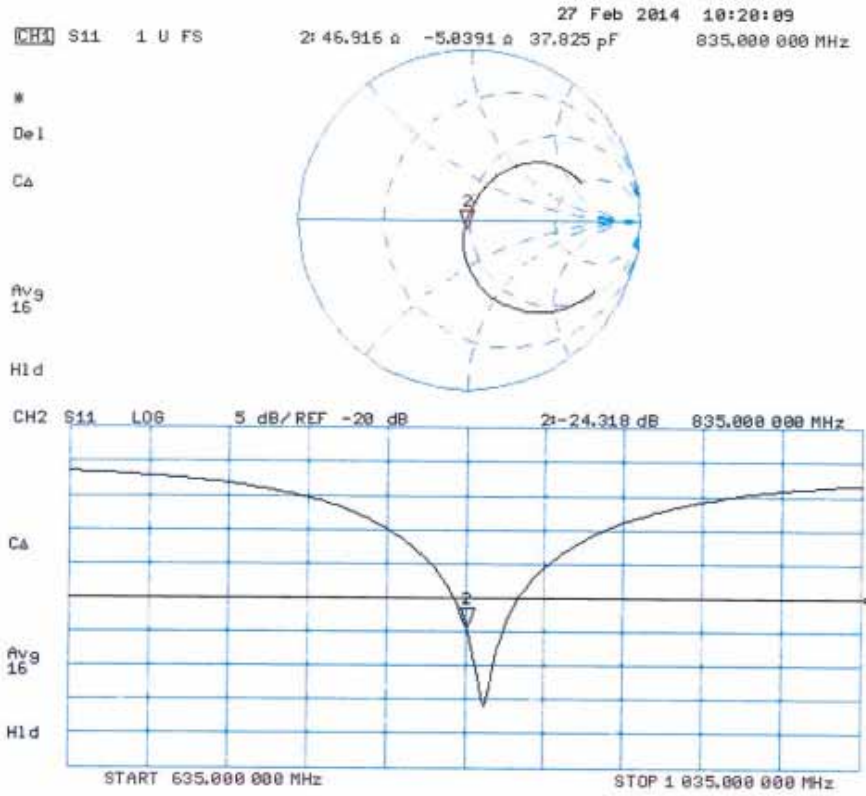

**Calibration Laboratory of  
Schmid & Partner  
Engineering AG**  
Zeughausstrasse 43, 8004 Zurich, Switzerland



**S** Schweizerischer Kalibrierdienst  
**C** Service suisse d'étalonnage  
**S** Servizio svizzero di taratura  
**S** Swiss Calibration Service

Accredited by the Swiss Accreditation Service (SAS)  
The Swiss Accreditation Service is one of the signatories to the EA  
Multilateral Agreement for the recognition of calibration certificates

Accreditation No.: **SCS 108**

Client **Quietek-CN (Auden)**

Certificate No: **D1900V2-5d121\_Feb14**

## CALIBRATION CERTIFICATE

Object: **D1900V2 - SN: 5d121**

Calibration procedure(s): **QA CAL-05.v9  
Calibration procedure for dipole validation kits above 700 MHz**

Calibration date: **February 27, 2014**

This calibration certificate documents the traceability to national standards, which realize the physical units of measurements (SI).  
The measurements and the uncertainties with confidence probability are given on the following pages and are part of the certificate.

All calibrations have been conducted in the closed laboratory facility: environment temperature (22 ± 3)°C and humidity < 70%.

Calibration Equipment used (M&TE critical for calibration)

Primary Standards	ID #	Cal Date (Certificate No.)	Scheduled Calibration
Power meter EPM-442A	GB37480704	09-Oct-13 (No. 217-01827)	Oct-14
Power sensor HP 8481A	US37292783	09-Oct-13 (No. 217-01827)	Oct-14
Power sensor HP 8481A	MY41092317	09-Oct-13 (No. 217-01828)	Oct-14
Reference 20 dB Attenuator	SN: 5058 (20k)	04-Apr-13 (No. 217-01736)	Apr-14
Type-N mismatch combination	SN: 5047.3 / 06327	04-Apr-13 (No. 217-01739)	Apr-14
Reference Probe ES3DV3	SN: 3205	30-Dec-13 (No. ES3-3205_Dec13)	Dec-14
DAE4	SN: 601	25-Apr-13 (No. DAE4-601_Apr13)	Apr-14
Secondary Standards	ID #	Check Date (in house)	Scheduled Check
RF generator R&S SMT-06	100005	04-Aug-99 (in house check Oct-13)	In house check: Oct-16
Network Analyzer HP 8753E	US37390585 S4206	18-Oct-01 (in house check Oct-13)	In house check: Oct-14

	<b>Name</b>	<b>Function</b>	<b>Signature</b>
Calibrated by:	Jeton Kastrati	Laboratory Technician	
Approved by:	Katja Pokovic	Technical Manager	

Issued: February 28, 2014

This calibration certificate shall not be reproduced except in full without written approval of the laboratory.



**Calibration Laboratory of  
Schmid & Partner  
Engineering AG**  
Zeughausstrasse 43, 8004 Zurich, Switzerland



**S** Schweizerischer Kalibrierdienst  
**C** Service suisse d'étalonnage  
**S** Servizio svizzero di taratura  
**S** Swiss Calibration Service

Accredited by the Swiss Accreditation Service (SAS)  
The Swiss Accreditation Service is one of the signatories to the EA  
Multilateral Agreement for the recognition of calibration certificates

Accreditation No.: **SCS 108**

**Glossary:**

TSL	tissue simulating liquid
ConvF	sensitivity in TSL / NORM x,y,z
N/A	not applicable or not measured

**Calibration is Performed According to the Following Standards:**

- a) IEEE Std 1528-2013, "IEEE Recommended Practice for Determining the Peak Spatial-Averaged Specific Absorption Rate (SAR) in the Human Head from Wireless Communications Devices: Measurement Techniques", June 2013
- b) IEC 62209-1, "Procedure to measure the Specific Absorption Rate (SAR) for hand-held devices used in close proximity to the ear (frequency range of 300 MHz to 3 GHz)", February 2005
- c) KDB 865664, "SAR Measurement Requirements for 100 MHz to 6 GHz"

**Additional Documentation:**

- d) DASY4/5 System Handbook

**Methods Applied and Interpretation of Parameters:**

- *Measurement Conditions:* Further details are available from the Validation Report at the end of the certificate. All figures stated in the certificate are valid at the frequency indicated.
- *Antenna Parameters with TSL:* The dipole is mounted with the spacer to position its feed point exactly below the center marking of the flat phantom section, with the arms oriented parallel to the body axis.
- *Feed Point Impedance and Return Loss:* These parameters are measured with the dipole positioned under the liquid filled phantom. The impedance stated is transformed from the measurement at the SMA connector to the feed point. The Return Loss ensures low reflected power. No uncertainty required.
- *Electrical Delay:* One-way delay between the SMA connector and the antenna feed point. No uncertainty required.
- *SAR measured:* SAR measured at the stated antenna input power.
- *SAR normalized:* SAR as measured, normalized to an input power of 1 W at the antenna connector.
- *SAR for nominal TSL parameters:* The measured TSL parameters are used to calculate the nominal SAR result.

The reported uncertainty of measurement is stated as the standard uncertainty of measurement multiplied by the coverage factor  $k=2$ , which for a normal distribution corresponds to a coverage probability of approximately 95%.

## Measurement Conditions

DASY system configuration, as far as not given on page 1.

DASY Version	DASY5	V52.8.7
Extrapolation	Advanced Extrapolation	
Phantom	Modular Flat Phantom	
Distance Dipole Center - TSL	10 mm	with Spacer
Zoom Scan Resolution	dx, dy, dz = 5 mm	
Frequency	1900 MHz ± 1 MHz	

## Head TSL parameters

The following parameters and calculations were applied.

	Temperature	Permittivity	Conductivity
Nominal Head TSL parameters	22.0 °C	40.0	1.40 mho/m
Measured Head TSL parameters	(22.0 ± 0.2) °C	38.9 ± 6 %	1.39 mho/m ± 6 %
Head TSL temperature change during test	< 0.5 °C	----	----

## SAR result with Head TSL

SAR averaged over 1 cm <sup>3</sup> (1 g) of Head TSL	Condition	
SAR measured	250 mW input power	10.3 W/kg
SAR for nominal Head TSL parameters	normalized to 1W	<b>41.1 W/kg ± 17.0 % (k=2)</b>

SAR averaged over 10 cm <sup>3</sup> (10 g) of Head TSL	condition	
SAR measured	250 mW input power	5.34 W/kg
SAR for nominal Head TSL parameters	normalized to 1W	<b>21.3 W/kg ± 16.5 % (k=2)</b>

## Body TSL parameters

The following parameters and calculations were applied.

	Temperature	Permittivity	Conductivity
Nominal Body TSL parameters	22.0 °C	53.3	1.52 mho/m
Measured Body TSL parameters	(22.0 ± 0.2) °C	52.8 ± 6 %	1.49 mho/m ± 6 %
Body TSL temperature change during test	< 0.5 °C	----	----

## SAR result with Body TSL

SAR averaged over 1 cm <sup>3</sup> (1 g) of Body TSL	Condition	
SAR measured	250 mW input power	9.83 W/kg
SAR for nominal Body TSL parameters	normalized to 1W	<b>39.7 W/kg ± 17.0 % (k=2)</b>

SAR averaged over 10 cm <sup>3</sup> (10 g) of Body TSL	condition	
SAR measured	250 mW input power	5.20 W/kg
SAR for nominal Body TSL parameters	normalized to 1W	<b>20.9 W/kg ± 16.5 % (k=2)</b>

**Appendix**

**Antenna Parameters with Head TSL**

Impedance, transformed to feed point	50.8 $\Omega$ + 6.6 j $\Omega$
Return Loss	- 23.6 dB

**Antenna Parameters with Body TSL**

Impedance, transformed to feed point	46.3 $\Omega$ + 7.2 j $\Omega$
Return Loss	- 21.6 dB

**General Antenna Parameters and Design**

Electrical Delay (one direction)	1.202 ns
----------------------------------	----------

After long term use with 100W radiated power, only a slight warming of the dipole near the feedpoint can be measured.

The dipole is made of standard semirigid coaxial cable. The center conductor of the feeding line is directly connected to the second arm of the dipole. The antenna is therefore short-circuited for DC-signals. On some of the dipoles, small end caps are added to the dipole arms in order to improve matching when loaded according to the position as explained in the "Measurement Conditions" paragraph. The SAR data are not affected by this change. The overall dipole length is still according to the Standard.

No excessive force must be applied to the dipole arms, because they might bend or the soldered connections near the feedpoint may be damaged.

**Additional EUT Data**

Manufactured by	SPEAG
Manufactured on	August 25, 2009

## DASY5 Validation Report for Head TSL

Date: 27.02.2014

Test Laboratory: SPEAG, Zurich, Switzerland

**DUT: Dipole 1900 MHz; Type: D1900V2; Serial: D1900V2 - SN: 5d121**

Communication System: UID 0 - CW; Frequency: 1900 MHz

Medium parameters used:  $f = 1900$  MHz;  $\sigma = 1.39$  S/m;  $\epsilon_r = 38.9$ ;  $\rho = 1000$  kg/m<sup>3</sup>

Phantom section: Flat Section

Measurement Standard: DASY5 (IEEE/IEC/ANSI C63.19-2007)

DASY52 Configuration:

- Probe: ES3DV3 - SN3205; ConvF(5.06, 5.06, 5.06); Calibrated: 30.12.2013;
- Sensor-Surface: 3mm (Mechanical Surface Detection)
- Electronics: DAE4 Sn601; Calibrated: 25.04.2013
- Phantom: Flat Phantom 5.0 (front); Type: QD000P50AA; Serial: 1001
- DASY52 52.8.7(1137); SEMCAD X 14.6.10(7164)

### Dipole Calibration for Head Tissue/Pin=250 mW, d=10mm/Zoom Scan (7x7x7)/Cube 0:

Measurement grid: dx=5mm, dy=5mm, dz=5mm

Reference Value = 98.487 V/m; Power Drift = 0.04 dB

Peak SAR (extrapolated) = 19.0 W/kg

**SAR(1 g) = 10.3 W/kg; SAR(10 g) = 5.34 W/kg**

Maximum value of SAR (measured) = 12.8 W/kg

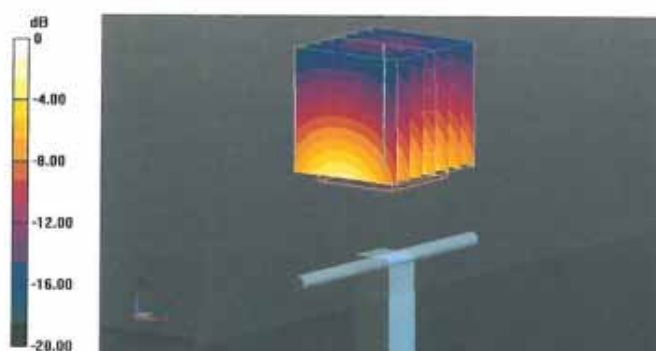

0 dB = 12.8 W/kg = 11.07 dBW/kg

Impedance Measurement Plot for Head TSL

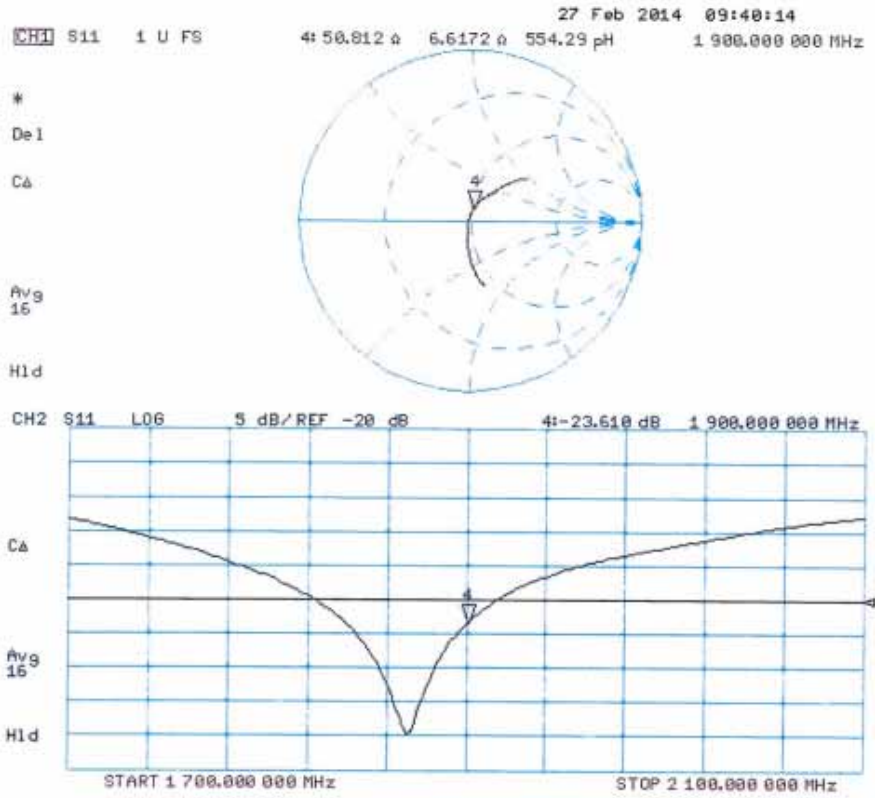

## DASY5 Validation Report for Body TSL

Date: 27.02.2014

Test Laboratory: SPEAG, Zurich, Switzerland

**DUT: Dipole 1900 MHz; Type: D1900V2; Serial: D1900V2 - SN: 5d121**

Communication System: UID 0 - CW; Frequency: 1900 MHz

Medium parameters used:  $f = 1900$  MHz;  $\sigma = 1.49$  S/m;  $\epsilon_r = 52.8$ ;  $\rho = 1000$  kg/m<sup>3</sup>

Phantom section: Flat Section

Measurement Standard: DASY5 (IEEE/IEC/ANSI C63.19-2007)

DASY52 Configuration:

- Probe: ES3DV3 - SN3205; ConvF(4.76, 4.76, 4.76); Calibrated: 30.12.2013;
- Sensor-Surface: 3mm (Mechanical Surface Detection)
- Electronics: DAE4 Sn601; Calibrated: 25.04.2013
- Phantom: Flat Phantom 5.0 (back); Type: QD000P50AA; Serial: 1002
- DASY52 52.8.7(1137); SEMCAD X 14.6.10(7164)

### Dipole Calibration for Body Tissue/Pin=250 mW, d=10mm/Zoom Scan (7x7x7)/Cube 0:

Measurement grid: dx=5mm, dy=5mm, dz=5mm

Reference Value = 95.066 V/m; Power Drift = -0.01 dB

Peak SAR (extrapolated) = 17.1 W/kg

**SAR(1 g) = 9.83 W/kg; SAR(10 g) = 5.2 W/kg**

Maximum value of SAR (measured) = 12.4 W/kg

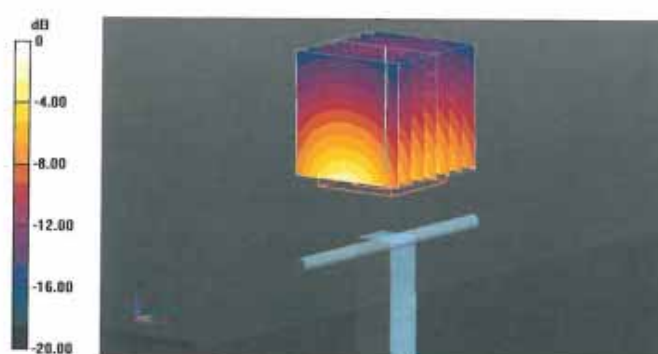

0 dB = 12.4 W/kg = 10.93 dBW/kg

Impedance Measurement Plot for Body TSL

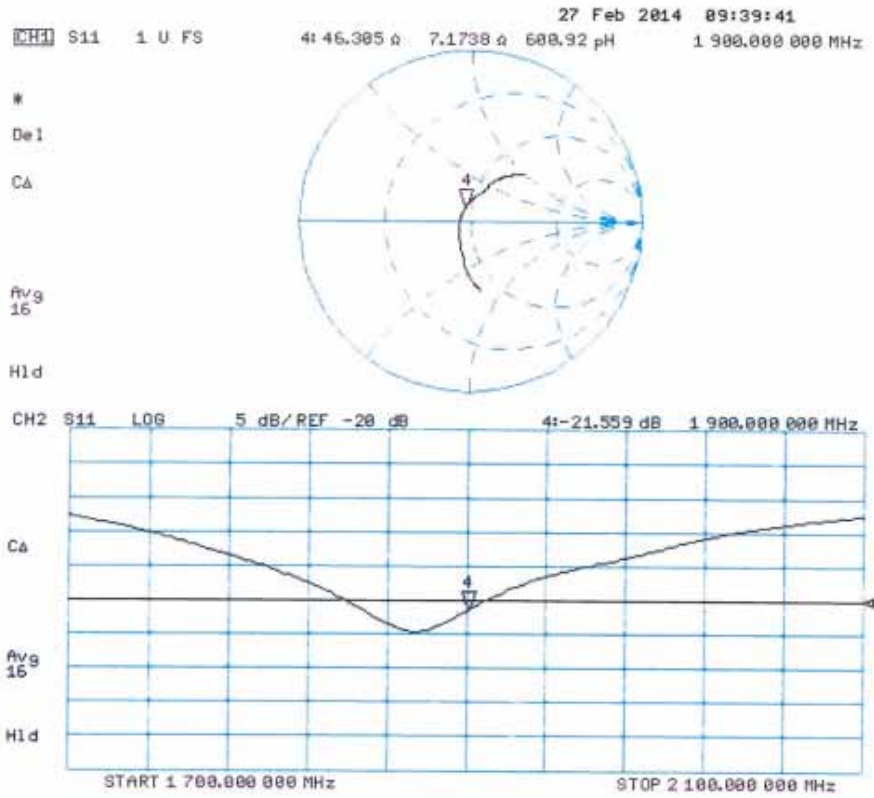

**Calibration Laboratory of  
Schmid & Partner  
Engineering AG**  
Zeughausstrasse 43, 8004 Zurich, Switzerland



**S** Schweizerischer Kalibrierdienst  
**C** Service suisse d'étalonnage  
**S** Servizio svizzero di taratura  
**S** Swiss Calibration Service

Accredited by the Swiss Accreditation Service (SAS)  
The Swiss Accreditation Service is one of the signatories to the EA  
Multilateral Agreement for the recognition of calibration certificates

Accreditation No.: **SCS 108**

Client **Quietek-CN (Auden)**

Certificate No: **D2450V2-839\_Feb14**

## CALIBRATION CERTIFICATE

Object: **D2450V2 - SN: 839**

Calibration procedure(s): **QA CAL-05.v9  
Calibration procedure for dipole validation kits above 700 MHz**

Calibration date: **February 24, 2014**

This calibration certificate documents the traceability to national standards, which realize the physical units of measurements (SI).  
The measurements and the uncertainties with confidence probability are given on the following pages and are part of the certificate.

All calibrations have been conducted in the closed laboratory facility: environment temperature (22 ± 3)°C and humidity < 70%.

Calibration Equipment used (M&TE critical for calibration)

Primary Standards	ID #	Cal Date (Certificate No.)	Scheduled Calibration
Power meter EPM-442A	GB37480704	09-Oct-13 (No. 217-01827)	Oct-14
Power sensor HP 8481A	US37292783	09-Oct-13 (No. 217-01827)	Oct-14
Power sensor HP 8481A	MY41092317	09-Oct-13 (No. 217-01828)	Oct-14
Reference 20 dB Attenuator	SN: 5058 (20k)	04-Apr-13 (No. 217-01736)	Apr-14
Type-N mismatch combination	SN: 5047.3 / 06327	04-Apr-13 (No. 217-01739)	Apr-14
Reference Probe ES3DV3	SN: 3205	30-Dec-13 (No. ES3-3205_Dec13)	Dec-14
DAE4	SN: 601	25-Apr-13 (No. DAE4-601_Apr13)	Apr-14
Secondary Standards	ID #	Check Date (in house)	Scheduled Check
RF generator R&S SMT-06	100005	04-Aug-99 (in house check Oct-13)	In house check: Oct-16
Network Analyzer HP 8753E	US37390585 S4206	18-Oct-01 (in house check Oct-13)	In house check: Oct-14

Calibrated by:	Name <b>Israe El-Naouq</b>	Function <b>Laboratory Technician</b>	Signature 
Approved by:	Name <b>Katja Pokovic</b>	Function <b>Technical Manager</b>	Signature 

Issued: February 24, 2014

This calibration certificate shall not be reproduced except in full without written approval of the laboratory.



**Calibration Laboratory of**  
 Schmid & Partner  
 Engineering AG  
 Zeughausstrasse 43, 8004 Zurich, Switzerland



**S** Schweizerischer Kalibrierdienst  
**C** Service suisse d'étalonnage  
**S** Servizio svizzero di taratura  
**S** Swiss Calibration Service

Accredited by the Swiss Accreditation Service (SAS)  
 The Swiss Accreditation Service is one of the signatories to the EA  
 Multilateral Agreement for the recognition of calibration certificates

Accreditation No.: **SCS 108**

**Glossary:**

TSL	tissue simulating liquid
ConvF	sensitivity in TSL / NORM x,y,z
N/A	not applicable or not measured

**Calibration is Performed According to the Following Standards:**

- a) IEEE Std 1528-2013, "IEEE Recommended Practice for Determining the Peak Spatial-Averaged Specific Absorption Rate (SAR) in the Human Head from Wireless Communications Devices: Measurement Techniques", June 2013
- b) IEC 62209-1, "Procedure to measure the Specific Absorption Rate (SAR) for hand-held devices used in close proximity to the ear (frequency range of 300 MHz to 3 GHz)", February 2005
- c) KDB 865664, "SAR Measurement Requirements for 100 MHz to 6 GHz"

**Additional Documentation:**

- d) DASY4/5 System Handbook

**Methods Applied and Interpretation of Parameters:**

- *Measurement Conditions:* Further details are available from the Validation Report at the end of the certificate. All figures stated in the certificate are valid at the frequency indicated.
- *Antenna Parameters with TSL:* The dipole is mounted with the spacer to position its feed point exactly below the center marking of the flat phantom section, with the arms oriented parallel to the body axis.
- *Feed Point Impedance and Return Loss:* These parameters are measured with the dipole positioned under the liquid filled phantom. The impedance stated is transformed from the measurement at the SMA connector to the feed point. The Return Loss ensures low reflected power. No uncertainty required.
- *Electrical Delay:* One-way delay between the SMA connector and the antenna feed point. No uncertainty required.
- *SAR measured:* SAR measured at the stated antenna input power.
- *SAR normalized:* SAR as measured, normalized to an input power of 1 W at the antenna connector.
- *SAR for nominal TSL parameters:* The measured TSL parameters are used to calculate the nominal SAR result.

The reported uncertainty of measurement is stated as the standard uncertainty of measurement multiplied by the coverage factor k=2, which for a normal distribution corresponds to a coverage probability of approximately 95%.

**Measurement Conditions**

DASY system configuration, as far as not given on page 1.

DASY Version	DASY5	V52.8.7
Extrapolation	Advanced Extrapolation	
Phantom	Modular Flat Phantom	
Distance Dipole Center - TSL	10 mm	with Spacer
Zoom Scan Resolution	dx, dy, dz = 5 mm	
Frequency	2450 MHz ± 1 MHz	

**Head TSL parameters**

The following parameters and calculations were applied.

	Temperature	Permittivity	Conductivity
Nominal Head TSL parameters	22.0 °C	39.2	1.80 mho/m
Measured Head TSL parameters	(22.0 ± 0.2) °C	38.1 ± 6 %	1.86 mho/m ± 6 %
Head TSL temperature change during test	< 0.5 °C	----	----

**SAR result with Head TSL**

SAR averaged over 1 cm <sup>3</sup> (1 g) of Head TSL	Condition	
SAR measured	250 mW input power	13.3 W/kg
SAR for nominal Head TSL parameters	normalized to 1W	<b>52.0 W/kg ± 17.0 % (k=2)</b>

SAR averaged over 10 cm <sup>3</sup> (10 g) of Head TSL	condition	
SAR measured	250 mW input power	6.15 W/kg
SAR for nominal Head TSL parameters	normalized to 1W	<b>24.3 W/kg ± 16.5 % (k=2)</b>

**Body TSL parameters**

The following parameters and calculations were applied.

	Temperature	Permittivity	Conductivity
Nominal Body TSL parameters	22.0 °C	52.7	1.95 mho/m
Measured Body TSL parameters	(22.0 ± 0.2) °C	50.7 ± 6 %	2.02 mho/m ± 6 %
Body TSL temperature change during test	< 0.5 °C	----	----

**SAR result with Body TSL**

SAR averaged over 1 cm <sup>3</sup> (1 g) of Body TSL	Condition	
SAR measured	250 mW input power	12.8 W/kg
SAR for nominal Body TSL parameters	normalized to 1W	<b>49.9 W/kg ± 17.0 % (k=2)</b>

SAR averaged over 10 cm <sup>3</sup> (10 g) of Body TSL	condition	
SAR measured	250 mW input power	5.86 W/kg
SAR for nominal Body TSL parameters	normalized to 1W	<b>23.1 W/kg ± 16.5 % (k=2)</b>

**Appendix**

**Antenna Parameters with Head TSL**

Impedance, transformed to feed point	54.5 $\Omega$ + 2.4 j $\Omega$
Return Loss	- 26.2 dB

**Antenna Parameters with Body TSL**

Impedance, transformed to feed point	50.6 $\Omega$ + 4.3 j $\Omega$
Return Loss	- 27.4 dB

**General Antenna Parameters and Design**

Electrical Delay (one direction)	1.159 ns
----------------------------------	----------

After long term use with 100W radiated power, only a slight warming of the dipole near the feedpoint can be measured.

The dipole is made of standard semirigid coaxial cable. The center conductor of the feeding line is directly connected to the second arm of the dipole. The antenna is therefore short-circuited for DC-signals. On some of the dipoles, small end caps are added to the dipole arms in order to improve matching when loaded according to the position as explained in the "Measurement Conditions" paragraph. The SAR data are not affected by this change. The overall dipole length is still according to the Standard.

No excessive force must be applied to the dipole arms, because they might bend or the soldered connections near the feedpoint may be damaged.

**Additional EUT Data**

Manufactured by	SPEAG
Manufactured on	July 20, 2009

## DASY5 Validation Report for Head TSL

Date: 24.02.2014

Test Laboratory: SPEAG, Zurich, Switzerland

**DUT: Dipole 2450 MHz; Type: D2450V2; Serial: D2450V2 - SN: 839**

Communication System: UID 0 - CW; Frequency: 2450 MHz

Medium parameters used:  $f = 2450$  MHz;  $\sigma = 1.86$  S/m;  $\epsilon_r = 38.1$ ;  $\rho = 1000$  kg/m<sup>3</sup>

Phantom section: Flat Section

Measurement Standard: DASY5 (IEEE/IEC/ANSI C63.19-2007)

DASY52 Configuration:

- Probe: ES3DV3 - SN3205; ConvF(4.53, 4.53, 4.53); Calibrated: 30.12.2013;
- Sensor-Surface: 3mm (Mechanical Surface Detection)
- Electronics: DAE4 Sn601; Calibrated: 25.04.2013
- Phantom: Flat Phantom 5.0 (front); Type: QD000P50AA; Serial: 1001
- DASY52 52.8.7(1137); SEMCAD X 14.6.10(7164)

### Dipole Calibration for Head Tissue/Pin=250 mW, d=10mm/Zoom Scan (7x7x7)/Cube 0:

Measurement grid: dx=5mm, dy=5mm, dz=5mm

Reference Value = 99.591 V/m; Power Drift = 0.05 dB

Peak SAR (extrapolated) = 27.9 W/kg

**SAR(1 g) = 13.3 W/kg; SAR(10 g) = 6.15 W/kg**

Maximum value of SAR (measured) = 17.0 W/kg

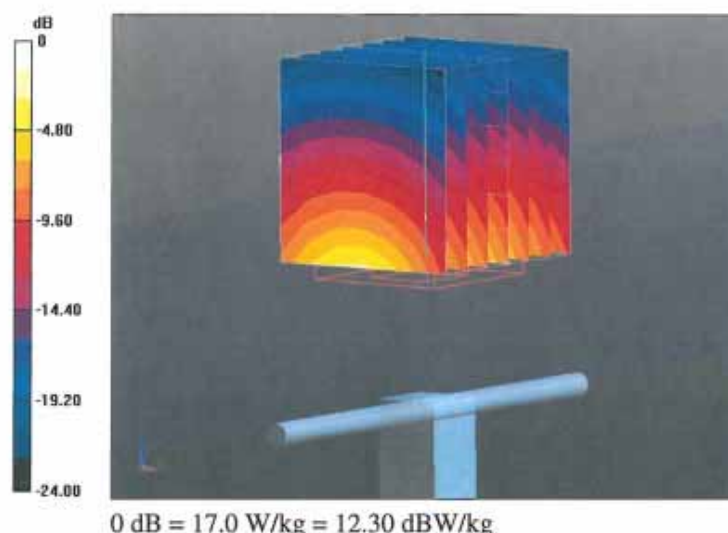

Impedance Measurement Plot for Head TSL

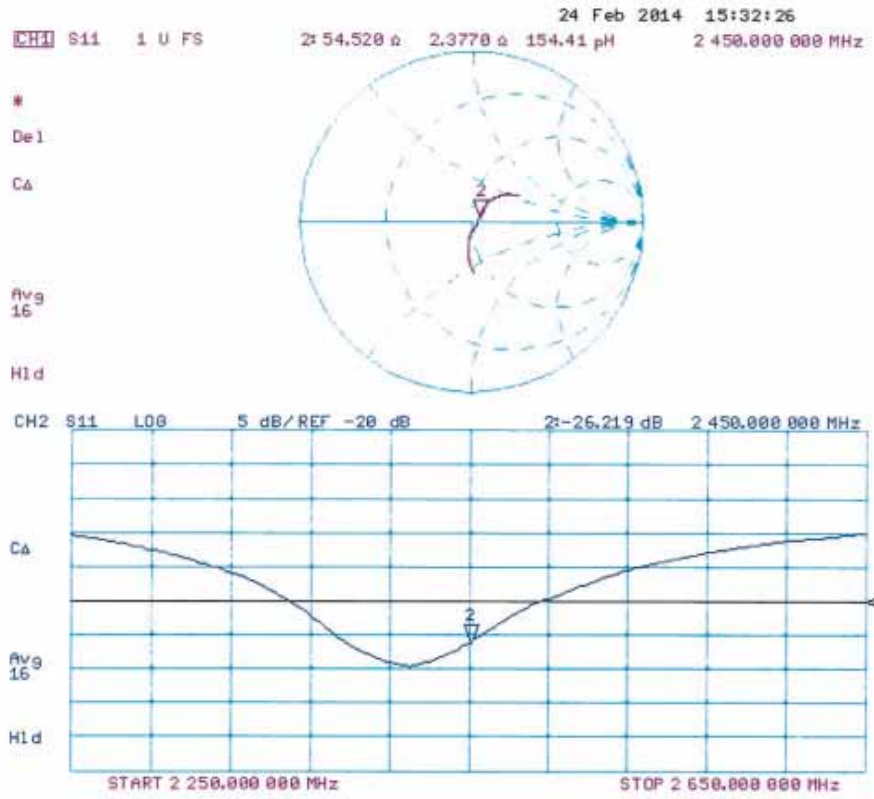

## DASY5 Validation Report for Body TSL

Date: 24.02.2014

Test Laboratory: SPEAG, Zurich, Switzerland

**DUT: Dipole 2450 MHz; Type: D2450V2; Serial: D2450V2 - SN: 839**

Communication System: UID 0 - CW; Frequency: 2450 MHz

Medium parameters used:  $f = 2450$  MHz;  $\sigma = 2.02$  S/m;  $\epsilon_r = 50.7$ ;  $\rho = 1000$  kg/m<sup>3</sup>

Phantom section: Flat Section

Measurement Standard: DASY5 (IEEE/IEC/ANSI C63.19-2007)

DASY52 Configuration:

- Probe: ES3DV3 - SN3205; ConvF(4.35, 4.35, 4.35); Calibrated: 30.12.2013;
- Sensor-Surface: 3mm (Mechanical Surface Detection)
- Electronics: DAE4 Sn601; Calibrated: 25.04.2013
- Phantom: Flat Phantom 5.0 (back); Type: QD000P50AA; Serial: 1002
- DASY52 52.8.7(1137); SEMCAD X 14.6.10(7164)

### Dipole Calibration for Body Tissue/Pin=250 mW, d=10mm/Zoom Scan (7x7x7)/Cube 0:

Measurement grid: dx=5mm, dy=5mm, dz=5mm

Reference Value = 94.267 V/m; Power Drift = -0.01 dB

Peak SAR (extrapolated) = 27.1 W/kg

**SAR(1 g) = 12.8 W/kg; SAR(10 g) = 5.86 W/kg**

Maximum value of SAR (measured) = 17.0 W/kg

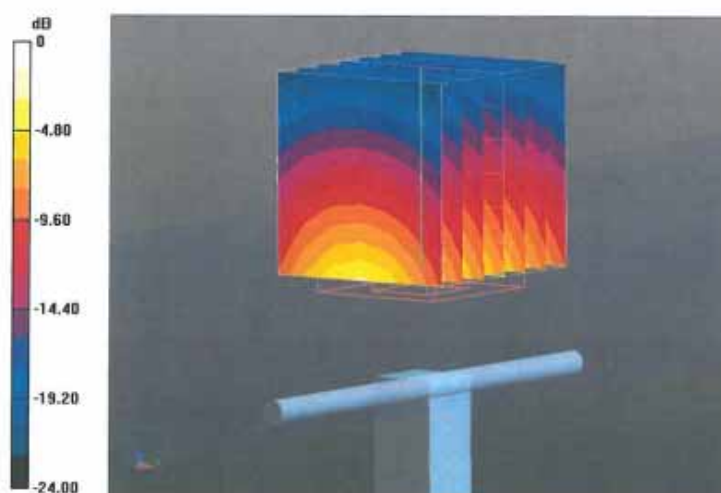

0 dB = 17.0 W/kg = 12.30 dBW/kg

Impedance Measurement Plot for Body TSL

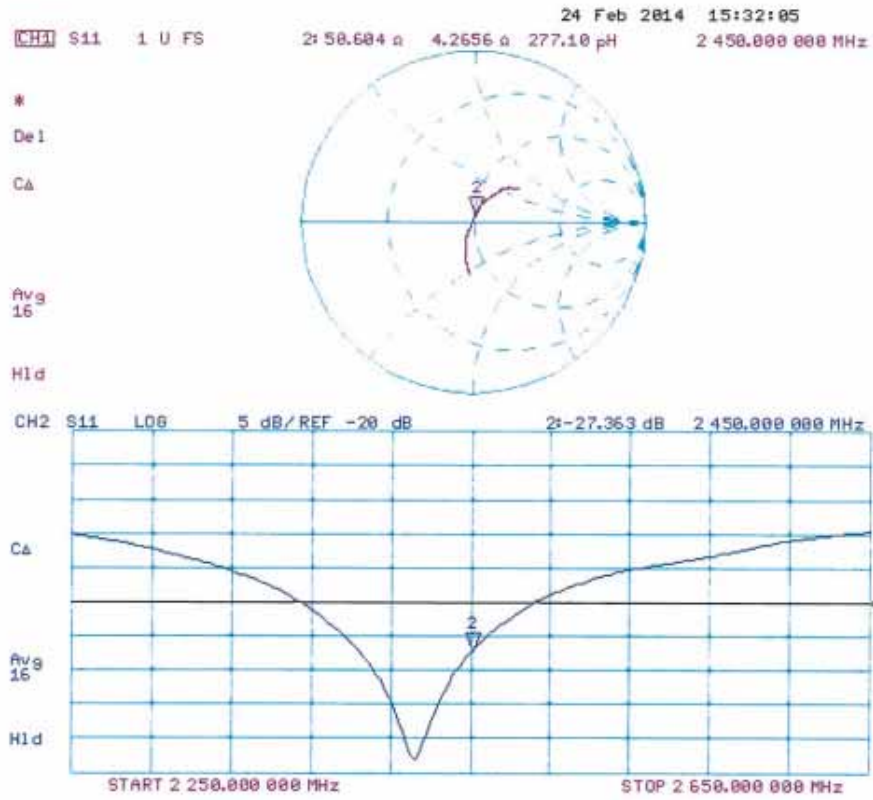

**Appendix F. DAE Calibration Data**

**Calibration Laboratory of  
Schmid & Partner  
Engineering AG**  
Zeughausstrasse 43, 8004 Zurich, Switzerland



**S** Schweizerischer Kalibrierdienst  
**C** Service suisse d'étalonnage  
**S** Servizio svizzero di taratura  
**S** Swiss Calibration Service

Accredited by the Swiss Accreditation Service (SAS)  
The Swiss Accreditation Service is one of the signatories to the EA  
Multilateral Agreement for the recognition of calibration certificates

Accreditation No.: **SCS 108**

Client **Quietek-CN (Auden)**

Certificate No: **DAE4-1220\_Jan14**

**CALIBRATION CERTIFICATE**

Object **DAE4 - SD 000 D04 BM - SN: 1220**

Calibration procedure(s) **QA CAL-06.v26  
Calibration procedure for the data acquisition electronics (DAE)**

Calibration date: **January 22, 2014**

This calibration certificate documents the traceability to national standards, which realize the physical units of measurements (SI).  
The measurements and the uncertainties with confidence probability are given on the following pages and are part of the certificate.

All calibrations have been conducted in the closed laboratory facility: environment temperature (22 ± 3)°C and humidity < 70%.

Calibration Equipment used (M&TE critical for calibration)

Primary Standards	ID #	Cal Date (Certificate No.)	Scheduled Calibration
Keithley Multimeter Type 2001	SN: 0810278	01-Oct-13 (No:13976)	Oct-14
Secondary Standards	ID #	Check Date (in house)	Scheduled Check
Auto DAE Calibration Unit	SE UWS 053 AA 1001	07-Jan-14 (in house check)	In house check: Jan-15
Calibrator Box V2.1	SE UMS 006 AA 1002	07-Jan-14 (in house check)	In house check: Jan-15

	Name	Function	Signature
Calibrated by:	R.Mayoraz	Technician	<i>R. Mayoraz</i>
Approved by:	Fin Bomholt	Deputy Technical Manager	<i>F. Bomholt</i>

Issued: January 22, 2014

This calibration certificate shall not be reproduced except in full without written approval of the laboratory.



**Calibration Laboratory of  
Schmid & Partner  
Engineering AG**  
Zeughausstrasse 43, 8004 Zurich, Switzerland



**S** Schweizerischer Kalibrierdienst  
**C** Service suisse d'étalonnage  
**S** Servizio svizzero di taratura  
**S** Swiss Calibration Service

Accredited by the Swiss Accreditation Service (SAS)  
The Swiss Accreditation Service is one of the signatories to the EA  
Multilateral Agreement for the recognition of calibration certificates

Accreditation No.: **SCS 108**

## Glossary

**DAE** data acquisition electronics  
**Connector angle** information used in DASY system to align probe sensor X to the robot coordinate system.

## Methods Applied and Interpretation of Parameters

- *DC Voltage Measurement*: Calibration Factor assessed for use in DASY system by comparison with a calibrated instrument traceable to national standards. The figure given corresponds to the full scale range of the voltmeter in the respective range.
- *Connector angle*: The angle of the connector is assessed measuring the angle mechanically by a tool inserted. Uncertainty is not required.
- The following parameters as documented in the Appendix contain technical information as a result from the performance test and require no uncertainty.
  - *DC Voltage Measurement Linearity*: Verification of the Linearity at +10% and -10% of the nominal calibration voltage. Influence of offset voltage is included in this measurement.
  - *Common mode sensitivity*: Influence of a positive or negative common mode voltage on the differential measurement.
  - *Channel separation*: Influence of a voltage on the neighbor channels not subject to an input voltage.
  - *AD Converter Values with inputs shorted*: Values on the internal AD converter corresponding to zero input voltage
  - *Input Offset Measurement*: Output voltage and statistical results over a large number of zero voltage measurements.
  - *Input Offset Current*: Typical value for information; Maximum channel input offset current, not considering the input resistance.
  - *Input resistance*: Typical value for information: DAE input resistance at the connector, during internal auto-zeroing and during measurement.
  - *Low Battery Alarm Voltage*: Typical value for information. Below this voltage, a battery alarm signal is generated.
  - *Power consumption*: Typical value for information. Supply currents in various operating modes.

**DC Voltage Measurement**

A/D - Converter Resolution nominal

High Range: 1LSB = 6.1 $\mu$ V, full range = -100...+300 mV

Low Range: 1LSB = 61nV, full range = -1.....+3mV

DASY measurement parameters: Auto Zero Time: 3 sec; Measuring time: 3 sec

Calibration Factors	X	Y	Z
High Range	405.217 $\pm$ 0.02% (k=2)	404.944 $\pm$ 0.02% (k=2)	404.170 $\pm$ 0.02% (k=2)
Low Range	3.97747 $\pm$ 1.50% (k=2)	3.99640 $\pm$ 1.50% (k=2)	3.98639 $\pm$ 1.50% (k=2)

**Connector Angle**

Connector Angle to be used in DASY system	176.5 $\pm$ 1 $^{\circ}$
---	--------------------------

Appendix

1. DC Voltage Linearity

High Range	Reading ( $\mu$ V)	Difference ( $\mu$ V)	Error (%)
Channel X + Input	199996.00	0.76	0.00
Channel X + Input	20002.66	1.98	0.01
Channel X - Input	-19998.07	2.88	-0.01
Channel Y + Input	199996.91	1.60	0.00
Channel Y + Input	20001.20	0.56	0.00
Channel Y - Input	-20001.74	-0.74	0.00
Channel Z + Input	199994.91	-0.44	-0.00
Channel Z + Input	20000.27	-0.23	-0.00
Channel Z - Input	-20001.65	-0.63	0.00

Low Range	Reading ( $\mu$ V)	Difference ( $\mu$ V)	Error (%)
Channel X + Input	2001.09	0.27	0.01
Channel X + Input	202.00	0.81	0.40
Channel X - Input	-197.89	0.69	-0.35
Channel Y + Input	2000.99	0.22	0.01
Channel Y + Input	200.07	-1.02	-0.50
Channel Y - Input	-201.19	-2.34	1.18
Channel Z + Input	2000.92	0.16	0.01
Channel Z + Input	200.20	-0.82	-0.41
Channel Z - Input	-199.32	-0.45	0.23

2. Common mode sensitivity

DASY measurement parameters: Auto Zero Time: 3 sec; Measuring time: 3 sec

	Common mode Input Voltage (mV)	High Range Average Reading ( $\mu$ V)	Low Range Average Reading ( $\mu$ V)
Channel X	200	10.55	8.63
	- 200	-6.76	-8.77
Channel Y	200	-9.89	-10.34
	- 200	7.59	7.71
Channel Z	200	12.72	12.38
	- 200	-13.94	-14.25

3. Channel separation

DASY measurement parameters: Auto Zero Time: 3 sec; Measuring time: 3 sec

	Input Voltage (mV)	Channel X ( $\mu$ V)	Channel Y ( $\mu$ V)	Channel Z ( $\mu$ V)
Channel X	200	-	1.02	-3.16
Channel Y	200	8.35	-	2.35
Channel Z	200	10.56	5.06	-

**4. AD-Converter Values with inputs shorted**

DASY measurement parameters: Auto Zero Time: 3 sec; Measuring time: 3 sec

	High Range (LSB)	Low Range (LSB)
Channel X	15888	15493
Channel Y	16012	15900
Channel Z	15706	16099

**5. Input Offset Measurement**

DASY measurement parameters: Auto Zero Time: 3 sec; Measuring time: 3 sec

Input 10M $\Omega$

	Average ( $\mu$ V)	min. Offset ( $\mu$ V)	max. Offset ( $\mu$ V)	Std. Deviation ( $\mu$ V)
Channel X	1.13	-0.62	2.79	0.50
Channel Y	-0.89	-2.63	0.76	0.48
Channel Z	-0.60	-2.36	0.94	0.50

**6. Input Offset Current**

Nominal Input circuitry offset current on all channels: <25fA

**7. Input Resistance** (Typical values for information)

	Zeroing (kOhm)	Measuring (MOhm)
Channel X	200	200
Channel Y	200	200
Channel Z	200	200

**8. Low Battery Alarm Voltage** (Typical values for information)

Typical values	Alarm Level (VDC)
Supply (+ Vcc)	+7.9
Supply (- Vcc)	-7.6

**9. Power Consumption** (Typical values for information)

Typical values	Switched off (mA)	Stand by (mA)	Transmitting (mA)
Supply (+ Vcc)	+0.01	+6	+14
Supply (- Vcc)	-0.01	-8	-9