



FCC&IC TEST REPORT

FCC ID: 2AATL-N240A-SRL

IC: 12425AN240A-SRL

On Behalf of

FN-LINK TECHNOLOGY LIMITED

Wi-Fi/BT module

Model No.: N240A-SRL

Prepared for : FN-LINK TECHNOLOGY LIMITED
Address : No.8, Litong Road, Liuyang Economic & Technical Development
Zone, Changsha, Hunan, China

Prepared By : Shenzhen Alpha Product Testing Co., Ltd.
Address : Building i, No.2, Lixin Road, Fuyong Street, Bao'an District, 518103,
Shenzhen, Guangdong, China

Report Number : A2408219-C01-R08
Date of Receipt : September 6, 2024
Date of Test : September 6, 2024 – October 29, 2024
Date of Report : November 12, 2024
Version Number : V0
Result : Pass

TABLE OF CONTENTS

<u>Description</u>	<u>Page</u>
1. Summary of Standards And Results-----	6
1.1. Description of Standards and Results -----	6
2. General Information -----	7
2.1. Description of Device (EUT) -----	7
2.2. Accessories of Device (EUT) -----	8
2.3. Tested Supporting System Details-----	8
2.4. Block Diagram of connection between EUT and simulators-----	8
2.5. Test Mode Description -----	8
2.6. Test Conditions -----	8
2.7. Test Facility -----	9
2.8. Measurement Uncertainty -----	9
2.9. Test Equipment List-----	10
3. Spurious Emission-----	11
3.1. Test Limits-----	11
3.2. Test Procedure-----	13
3.3. Test Setup-----	14
3.4. Test Results-----	16
4. Power Line Conducted Emission-----	27
4.1. Test Limits-----	27
4.2. Test Procedure-----	27
4.3. Test Setup-----	27
4.4. Test Results-----	27
5. Conducted Maximum Output Power-----	30
5.1. Test limits-----	30
5.2. Test Procedure-----	30
5.3. Test Setup-----	30
5.4. Test Results-----	30
6. Peak Power Spectral Density -----	31
6.1. Test limits-----	31
6.2. Test Procedure-----	31
6.3. Test Setup-----	31
6.4. Test Results-----	31
7. Bandwidth-----	36
7.1. Test limits-----	36
7.2. Test Procedure-----	36
7.3. Test Setup-----	36
7.4. Test Results-----	36
8. Band Edge Check -----	44
8.1. Test limits-----	44
8.2. Test Procedure-----	44
8.3. Test Setup-----	44
8.4. Test Results-----	44
9. Frequency stability -----	51
9.1. Test limit -----	51
9.2. Test Procedure-----	51

9.3. Test Setup-----	51
9.4. Test Results-----	51
10. Antenna Requirement -----	53
10.1. Standard Requirement-----	53
10.2. Antenna Connected Construction -----	53
10.3. Results-----	53
11. Test Setup Photo -----	54
11.1. Photos of Radiated emission -----	54
11.2. Photos of Conducted Emission test-----	55

TEST REPORT DECLARATION

Applicant : FN-LINK TECHNOLOGY LIMITED

Address : No.8, Litong Road, Liuyang Economic & Technical Development Zone,
Changsha, Hunan, China

Manufacturer : FN-LINK TECHNOLOGY LIMITED

Address : No.8, Litong Road, Liuyang Economic & Technical Development Zone,
Changsha, Hunan, China

EUT Description : Wi-Fi/BT module

(A) Model No. : N240A-SRL

(B) Trademark :  欧智通

Measurement Standard Used:

**FCC Rules and Regulations Part 15 Subpart C Section 15.247,
RSS-247 Issue 3, RSS-Gen Issue 5, ANSI C63.10:2013**

The device described above is tested by Shenzhen Alpha Product Testing Co., Ltd. to determine the maximum emission levels emanating from the device. The maximum emission levels are compared to the FCC Part 15 Subpart C limits both conducted and radiated emissions. The test results are contained in this test report and Shenzhen Alpha Product Testing Co., Ltd. is assumed of full responsibility for the accuracy and completeness of these tests.

After the test, our opinion is that EUT compliance with the requirement of the above standards.

This report applies to above tested sample only. This report shall not be reproduced in parts without written approval of Shenzhen Alpha Product Testing Co., Ltd.

Tested by (name + signature).....: Yannis Wen
Project Engineer



Approved by (name + signature).....: Jack Xu
Project Manager



Date of issue.....: November 12, 2024

Revision History

Revision	Issue Date	Revisions	Revised By
V0	November 12, 2024	Initial released Issue	Yannis Wen

1. SUMMARY OF STANDARDS AND RESULTS

1.1. Description of Standards and Results

The EUT have been tested according to the applicable standards as referenced below:

Test Item	Standards Paragraph	Result
Conducted Emission	FCC Part 15: 15.207 RSS-GEN(8.8), ANSI C63.10 :2013	P
6dB Bandwidth	FCC PART 15:15.247(a)(2) RSS-247(5.2 a), ANSI C63.10 :2013	P
Output Power	FCC Part 15: 15.247(b)(3) RSS-247(5.4 d), ANSI C63.10 :2013	P
Radiated Spurious Emission	FCC Part 15: 15.209, FCC Part 15: 15.247(d) RSS-Gen(8.9), RSS-247(5.5), ANSI C63.10 :2013	P
Conducted Spurious & Band Edge Emission	FCC Part 15: 15.247(d) RSS-Gen(8.9), RSS-247(5.5), ANSI C63.10 :2013	P
Power Spectral Density	FCC PART 15:15.247(e) RSS-247(5.2 b), ANSI C63.10 :2013	P
Radiated Band Edge Emission	FCC Part 15: 15.247(d) RSS-GEN(6.13), ANSI C63.10 :2013	P
Frequency stability	RSS-GEN(6.11)	P
Antenna Requirement	FCC Part 15: 15.203 RSS-GEN(6.8)	P
Note:	1. P is an abbreviation for Pass. 2. F is an abbreviation for Fail. 3. N/A is an abbreviation for Not Applicable.	

1. Pass: The EUT complies with the essential requirements in the standard.
2. Frequency Stability: The manufacturer stated in the user's manual.
3. The conclusion of this test report is judged by actual test data without considering measurement uncertainty.

2. GENERAL INFORMATION

2.1. Description of Device (EUT)

Description/PMN : Wi-Fi/BT module

Model : N240A-SRL
Number/HVIN(s) :
Diff. : N/A

Test Voltage : DC 3.3V from USB adapter board

Radio Technology : Bluetooth BLE

Operation : 2402-2480MHz
frequency

Channel No. : 40 channels

Data rate : 1Mbps/2Mbps

Channel Separation : 2MHz

Modulation : GFSK

Antenna Type : PCB antenna, max gain 4.46dBi
(Antenna information is provided by applicant.)

Software Version : V1.0

Hardware :
version/FVIN : V1.0

Intend use : Residential, commercial and light industrial environment
environment

2.2. Accessories of Device (EUT)

Accessories : /
 Manufacturer : /
 Model : /
 Ratings : /

2.3. Tested Supporting System Details

No.	Description	Manufacturer	Model	Serial Number	Certification or SDOC
1.	Notebook	Thinkpad	E14	N/A	N/A

2.4. Block Diagram of connection between EUT and simulators

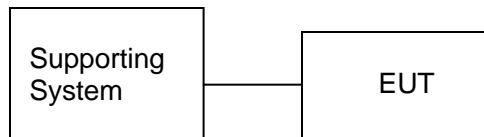

2.5. Test Mode Description

Tested mode, channel, and data rate information		
Mode	Channel	Frequency (MHz)
GFSK(1Mbps/2Mbps)	Low : CH0	2402
	Middle: CH19	2440
	High: CH39	2480

The test software was used to control EUT work in Continuous TX mode, and select test channel, wireless mode.

2.6. Test Conditions

Items	Required	Actual
Temperature range:	15-35°C	27°C
Humidity range:	25-75%	56%
Pressure range:	86-106kPa	98kPa

2.7. Test Facility

Shenzhen Alpha Product Testing Co., Ltd
 Building i, No.2, Lixin Road, Fuyong Street, Bao'an District, 518103,
 Shenzhen, Guangdong, China

June 21, 2018 File on Federal Communication Commission
 Registration Number: 293961
 Designation Number: CN1236

July 15, 2019 Certificated by IC
 Registration Number: 12135A

2.8. Measurement Uncertainty

(95% confidence levels, k=2)

Item	Uncertainty
Uncertainty for Power point Conducted Emissions Test	1.63dB
Uncertainty for Radiation Emission test in 3m chamber (below 30MHz)	3.5dB
Uncertainty for Radiation Emission test in 3m chamber (30MHz to 1GHz)	3.74dB(Polarize: V)
	3.76dB(Polarize: H)
Uncertainty for Radiation Emission test in 3m chamber (1GHz to 25GHz)	3.77dB(Polarize: V)
	3.80dB(Polarize: H)
Uncertainty for radio frequency	5.06×10^{-8} GHz
Uncertainty for conducted RF Power	0.40dB
Uncertainty for temperature	0.2°C
Uncertainty for humidity	1%
Uncertainty for DC and low frequency voltages	0.06%
Uncertainty for Power Spectral Density	0.39dB
Uncertainty for Occupied-Bandwidth	968Hz

2.9. Test Equipment List

Equipment	Manufacture	Model No.	Firmware version	Serial No.	Last cal.	Cal Interval
9*6*6 anechoic chamber	CHENYU	9*6*6	/	N/A	2022.05.18	3Year
Spectrum analyzer	ROHDE&SCHWARZ	FSV40-N	2.3	102137	2024.08.08	1Year
Spectrum analyzer	Agilent	N9020A	A.14.16	MY499100060	2024.08.08	1Year
Receiver	ROHDE&SCHWARZ	ESR	2.28 SP1	1316.3003K03-10 2082-Wa	2024.08.08	1Year
Receiver	R&S	ESCI	4.42 SP1	101165	2024.08.08	1Year
Bilog Antenna	Schwarzbeck	VULB 9168	/	VULB 9168#627	2023.08.28	2Year
Horn Antenna	SCHWARZBECK	BBHA 9120 D	/	2106	2023.08.19	2Year
Loop Antenna	SCHWARZBECK	FMZB 1519B	/	00128	2023.08.19	2Year
RF Cable	Resenberger	Cable 1	/	RE1	2024.08.08	1Year
RF Cable	Resenberger	Cable 2	/	RE2	2024.08.08	1Year
RF Cable	Resenberger	Cable 3	/	CE1	2024.08.08	1Year
Pre-amplifier	HP	HP8347A	/	2834A00455	2024.08.08	1Year
Pre-amplifier	Agilent	8449B	/	3008A02664	2024.08.08	1Year
L.I.S.N.#1	Schwarzbeck	NSLK8126	/	8126-466	2024.08.08	1Year
L.I.S.N.#2	ROHDE&SCHWARZ	ENV216	/	101043	2024.08.08	1Year
Horn Antenna	SCHWARZBECK	BBHA 9170	/	00946	2023.08.19	2Year
Preamplifier	SKET	LNPA_1840 -50	/	SK2018101801	2024.08.08	1 Year
Power Meter	Agilent	E9300A	/	MY41496628	2024.08.08	1 Year
Power Sensor	DARE	RPR3006W	/	15100041SNO91	2024.08.08	1 Year
Electronic Thermo-Hygrometer	S.H.Qixiang	HTC-1	/	N/A	2024.08.11	1 Year
Switching Mode Power Supply	JUNKE	JK12010S	/	20140927-6	2024.08.08	1 Year
Adjustable attenuator	MWRfTest	N/A	/	N/A	N/A	N/A
10dB Attenuator	Mini-Circuits	DC-6G	/	N/A	N/A	N/A

Software Information

Test Item	Software Name	Manufacturer	Version
RE	EZ-EMC	EZ	Alpha-3A1
CE	EZ-EMC	EZ	Alpha-3A1
RF-CE	MTS 8310	MW	V2.0.0.0

3. SPURIOUS EMISSION

3.1. Test Limits

All the emissions appearing within 15.205 restricted frequency bands shall not exceed the limits shown in 15.209, all the other emissions shall be at least 20dB below the fundamental emissions, or comply with 15.209 limits.

15.205 Restricted frequency band

MHz	MHz	MHz	GHz
0.090 - 0.110	16.42 - 16.423	399.9 - 410	4.5 - 5.15
¹ 0.495 - 0.505	16.69475 - 16.69525	608 - 614	5.35 - 5.46
2.1735 - 2.1905	16.80425 - 16.80475	960 - 1240	7.25 - 7.75
4.125 - 4.128	25.5 - 25.67	1300 - 1427	8.025 - 8.5
4.17725 - 4.17775	37.5 - 38.25	1435 - 1626.5	9.0 - 9.2
4.20725 - 4.20775	73 - 74.6	1645.5 - 1646.5	9.3 - 9.5
6.215 - 6.218	74.8 - 75.2	1660 - 1710	10.6 - 12.7
6.26775 - 6.26825	108 - 121.94	1718.8 - 1722.2	13.25 - 13.4
6.31175 - 6.31225	123 - 138	2200 - 2300	14.47 - 14.5
8.291 - 8.294	149.9 - 150.05	2310 - 2390	15.35 - 16.2
8.362 - 8.366	156.52475 - 156.52525	2483.5 - 2500	17.7 - 21.4
8.37625 - 8.38675	156.7 - 156.9	2690 - 2900	22.01 - 23.12
8.41425 - 8.41475	162.0125 - 167.17	3260 - 3267	23.6 - 24.0
12.29 - 12.293	167.72 - 173.2	3332 - 3339	31.2 - 31.8
12.51975 - 12.52025	240 - 285	3345.8 - 3358	36.43 - 36.5
12.57675 - 12.57725	322 - 335.4	3600 - 4400	(²)

RSS-GEN Restricted frequency band

Table 7 – Restricted frequency bands^{Note 1}

MHz	MHz	GHz
0.090 - 0.110	149.9 - 150.05	9.0 - 9.2
0.495 - 0.505	156.52475 - 156.52525	9.3 - 9.5
2.1735 - 2.1905	156.7 - 156.9	10.6 - 12.7
3.020 - 3.026	162.0125 - 167.17	13.25 - 13.4
4.125 - 4.128	167.72 - 173.2	14.47 - 14.5
4.17725 - 4.17775	240 - 285	15.35 - 16.2
4.20725 - 4.20775	322 - 335.4	17.7 - 21.4
5.677 - 5.683	399.9 - 410	22.01 - 23.12
6.215 - 6.218	608 - 614	23.6 - 24.0

6.26775 - 6.26825	960 - 1427	31.2 - 31.8
6.31175 - 6.31225	1435 - 1626.5	36.43 - 36.5
8.291 - 8.294	1645.5 - 1646.5	Above 38.6
8.362 - 8.366	1660 - 1710	
8.37625 - 8.38675	1718.8 - 1722.2	
8.41425 - 8.41475	2200 - 2300	
12.29 - 12.293	2310 - 2390	
12.51975 - 12.52025	2483.5 - 2500	
12.57675 - 12.57725	2655 - 2900	
13.36 - 13.41	3260 – 3267	
16.42 - 16.423	3332 - 3339	
16.69475 - 16.69525	3345.8 - 3358	
16.80425 - 16.80475	3500 - 4400	
25.5 - 25.67	4500 - 5150	
37.5 - 38.25	5350 - 5460	
73 - 74.6	7250 - 7750	
74.8 - 75.2	8025 – 8500	
108 – 138		

Note 1: Certain frequency bands listed in table 7 and in bands above 38.6 GHz are designated for licence-exempt applications. These frequency bands and the requirements that apply to related devices are set out in the 200 and 300 series of RSSs.

15.209 Limit

FREQUENCY MHz	DISTANCE Meters	FIELD STRENGTHS LIMIT	
		$\mu\text{V}/\text{m}$	$\text{dB}(\mu\text{V})/\text{m}$
0.009-0.490	300	$2400/\text{F}(\text{KHz})$	/
0.490-1.705	30	$24000/\text{F}(\text{KHz})$	/
1.705-30	30	30	29.5
30 ~ 88	3	100	40.0
88 ~ 216	3	150	43.5
216 ~ 960	3	200	46.0
960 ~ 1000	3	500	54.0
Above 1000	3	74.0 $\text{dB}(\mu\text{V})/\text{m}$ (Peak) 54.0 $\text{dB}(\mu\text{V})/\text{m}$ (Average)	

Note 1: The peak limit is 20 dB higher than the average limit

Note 2: Peak limit applies (AVG limit + 20 dB) as well as RSS-247 Section 5.5

Harmonic emissions limits comply with below 54 dBuV/m at 3m. Other emissions radiated outside of the specified frequency bands, except for harmonics, shall be attenuated by at least 50 dB below the level of the fundamental or comply with the radiated emissions limits specified in section 15.209(a) limit in the table below has to be followed.

Table 5 – General field strength limits at frequencies above 30 MHz

Frequency (MHz)	Field strength ($\mu\text{V}/\text{m}$ at 3 m)
30 – 88	100
88 – 216	150
216 – 960	200
Above 960	500

Table 6 – General field strength limits at frequencies below 30 MHz

Frequency	Magnetic field strength (H-Field) ($\mu\text{A}/\text{m}$)	Measurement distance (m)
9 - 490 kHz ^{Note 1}	$6.37/\text{F}$ (F in kHz)	300
490 - 1705 kHz	$63.7/\text{F}$ (F in kHz)	30
1.705 - 30 MHz	0.08	30

Note 1: The emission limits for the ranges 9-90 kHz and 110-490 kHz are based on measurements employing a linear average detector.

3.2. Test Procedure

The measuring distance of 3m shall be used for measurements at frequency up to 1GHz and above 1GHz. The EUT was placed on a rotating 0.8 m high above ground for below 1GHz and 1.5m high for above 1GHz testing, The table was rotated 360 degrees to determine the position of the highest radiation. The Test antenna shall vary between 1m and 4m, Both Horizontal and Vertical antenna are set of make measurement.

The initial step in collecting radiated emission data is a spectrum analyzer Peak detector mode pre-scanning the measurement frequency range. Significant Peaks are then marked, and then Quasi Peak Detector mode premeasured.

If Peak value comply with QP limit Below 1GHz, the EUT deemed to comply with QP limit. But the Peak value and average value both need to comply with applicable limit above 1GHz.

For the actual test configuration, please see the test setup photo.

3.3. Test Setup

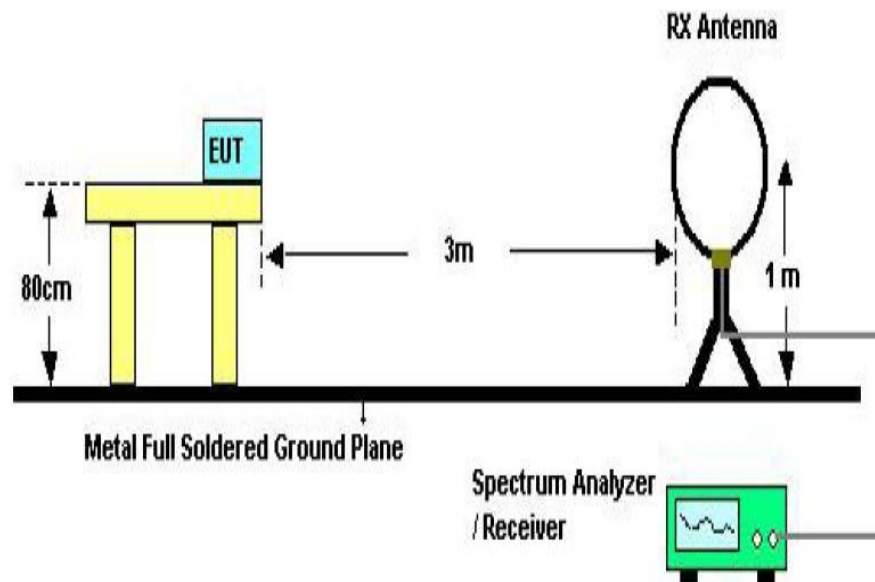

Below 30MHz Test Setup

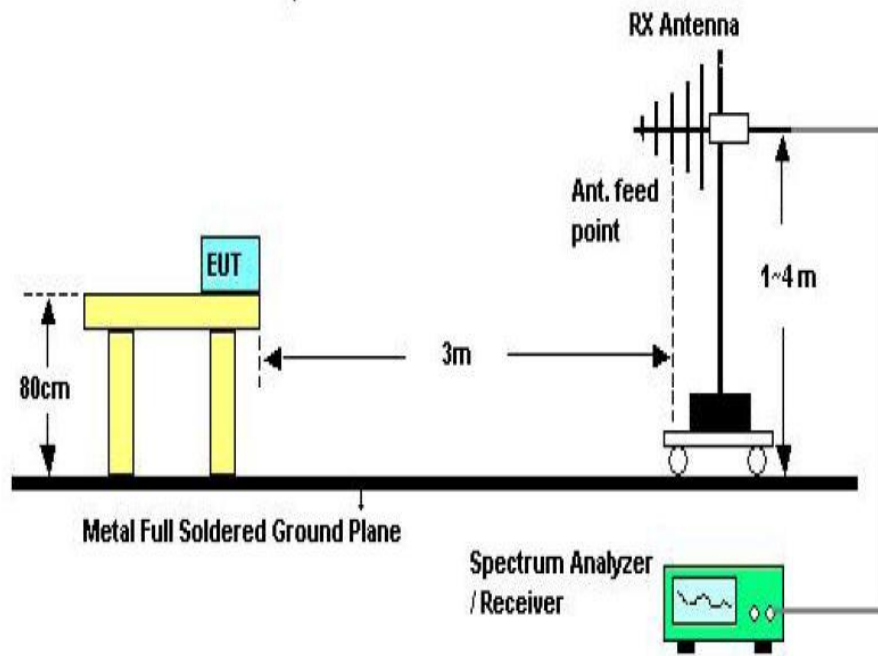

Above 30MHz Test Setup

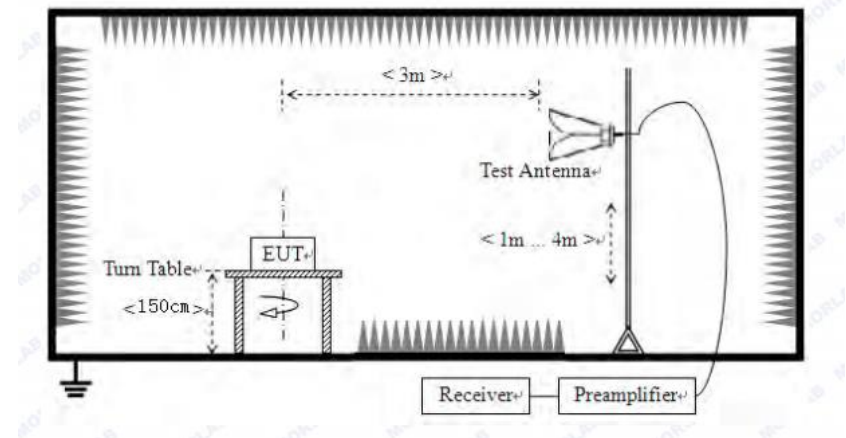

Above 1GHz Test Setup

3.4. Test Results

Test Condition

Continual Transmitting in maximum power.

9KHz~150KHz	RBW200Hz	VBW1KHz
150KHz~30MHz	RBW9KHz	VBW 30KHz
30MHz~1GHz	RBW120KHz	VBW 300KHz
Above1GHz	RBW1MHz	VBW 3MHz

We have scanned from 9 kHz to the 10th harmonic of the EUT.

Detailed information please see the following page.

From 9KHz to 30MHz: Conclusion: Pass

Note: 1.The amplitude of spurious emissions which are attenuated by more than 20dB below the permissible value has no need to be reported.

2. Only show the test data of the worst Channel in this report.

From 30MHz to 1000MHz: Conclusion: Pass

Vertical:

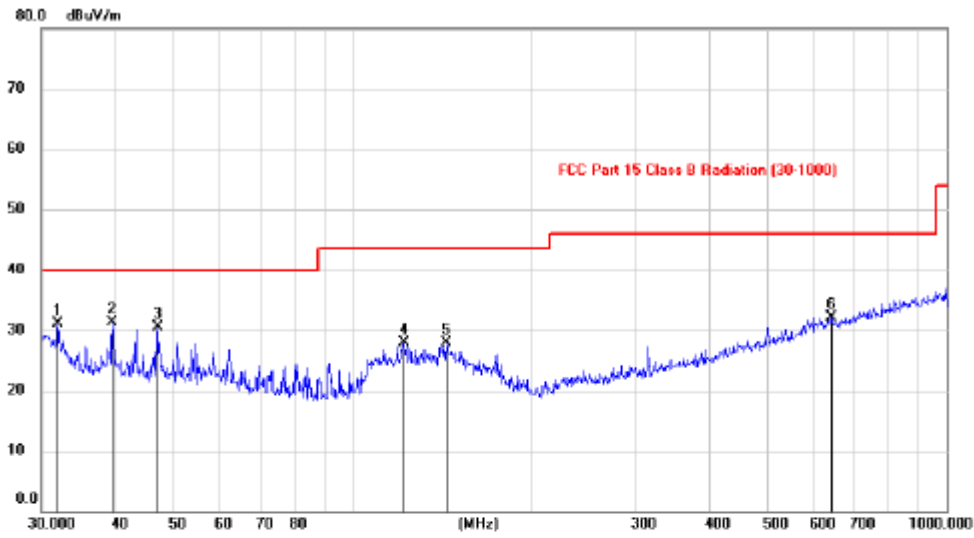

No.	Mk.	Freq.	Reading Level	Correct Factor	Measurement	Limit	Margin	Antenna Height	Table Degree
		MHz	dBuV	dB	dBuV/m	dBuV/m	dB	cm	degree
1		32.0331	17.59	13.60	31.19	40.00	-8.81	peak	
2	*	39.5018	16.91	14.47	31.38	40.00	-8.62	peak	
3		47.0113	16.39	14.07	30.46	40.00	-9.54	peak	
4		122.3754	14.72	13.17	27.89	43.50	-15.61	peak	
5		144.2187	13.33	14.82	27.95	43.50	-15.55	peak	
6		641.1354	11.09	20.98	32.07	46.00	-13.93	peak	

Note: 1. *:Maximum data; x:Over limit; !:over margin.

2.Measurement=Reading Level+Correct Factor; Correct Factor=Antenna Factor+Cable Loss.

Horizontal:

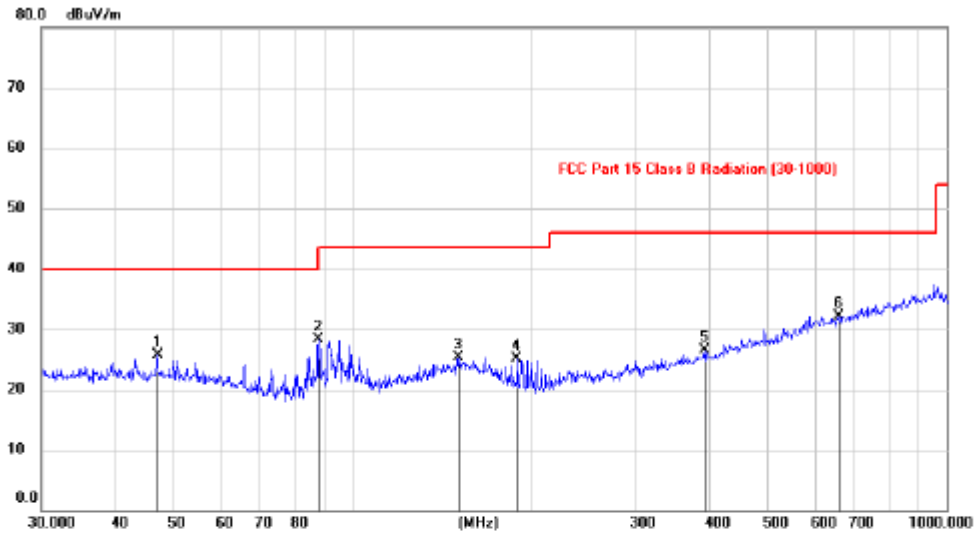

No.	Mk.	Freq.	Reading Level	Correct Factor	Measurement	Limit	Margin	Antenna Height	Table Degree
		MHz	dBuV	dB	dBuV/m	dBuV/m	dB	cm	degree
1		47.0277	11.72	14.07	25.79	40.00	-14.21	peak	
2	*	87.7555	18.34	10.01	28.35	40.00	-11.65	peak	
3		151.3140	10.33	15.06	25.39	43.50	-18.11	peak	
4		189.3619	13.63	11.55	25.18	43.50	-18.32	peak	
5		390.9967	10.47	16.10	26.57	46.00	-19.43	peak	
6		657.8358	10.98	21.18	32.16	46.00	-13.84	peak	

Note: 1. *:Maximum data; x:Over limit; !:over margin.

2.Measurement=Reading Level+Correct Factor; Correct Factor=Antenna Factor+Cable Loss.

Notes: Above is below 1GHz test data. This report only shall the worst case mode for TX 2440MHz.(1Mbps)

From 1G-25GHz(1Mbps):

Test Mode: TX Low									
Freq (MHz)	Read Level (dBuV/m)	Polar (H/V)	Antenna Factor (dB/m)	Cable loss(dB)	Amp Factor (dB)	Result (dBuV/m)	Limit (dBuV/m)	Margin (dB)	Remark
4804	43.09	V	33.95	10.18	34.26	52.96	74	-21.04	PK
4804	38.89	V	33.95	10.18	34.26	48.76	54	-5.24	AV
7206	/	/	/	/	/	/	/	/	/
9608	/	/	/	/	/	/	/	/	/
4804	43.10	H	33.95	10.18	34.26	52.97	74	-21.03	PK
4804	34.99	H	33.95	10.18	34.26	44.86	54	-9.14	AV
7206	/	/	/	/	/	/	/	/	/
9608	/	/	/	/	/	/	/	/	/
Test Mode: TX Mid									
4880	44.91	V	33.93	10.2	34.29	54.75	74	-19.25	PK
4880	36.19	V	33.93	10.2	34.29	46.03	54	-7.97	AV
7320	/	/	/	/	/	/	/	/	/
9760	/	/	/	/	/	/	/	/	/
4880	44.94	H	33.93	10.2	34.29	54.78	74	-19.22	PK
4880	34.24	H	33.93	10.2	34.29	44.08	54	-9.92	AV
7320	/	/	/	/	/	/	/	/	/
9760	/	/	/	/	/	/	/	/	/
Test Mode: TX High									
4960	43.26	V	33.98	10.22	34.25	53.21	74	-20.79	PK
4960	33.17	V	33.98	10.22	34.25	43.12	54	-10.88	AV
7440	/	/	/	/	/	/	/	/	/
9920	/	/	/	/	/	/	/	/	/
4960	43.92	H	33.98	10.22	34.25	53.87	74	-20.13	PK
4960	31.43	H	33.98	10.22	34.25	41.38	54	-12.62	AV
7440	/	/	/	/	/	/	/	/	/
9920	/	/	/	/	/	/	/	/	/
Note:									
1, Result = Read level + Antenna factor + cable loss-Amp factor									
2, All the other emissions not reported were too low to read and deemed to comply with FCC limit.									

From 1G-25GHz(2Mbps):

Test Mode: TX Low									
Freq (MHz)	Read Level (dBuV/m)	Polar (H/V)	Antenna Factor (dB/m)	Cable loss(dB)	Amp Factor (dB)	Result (dBuV/m)	Limit (dBuV/m)	Margin (dB)	Remark
4804	42.98	V	33.95	10.18	34.26	52.85	74	-21.15	PK
4804	36.04	V	33.95	10.18	34.26	45.91	54	-8.09	AV
7206	/	/	/	/	/	/	/	/	/
9608	/	/	/	/	/	/	/	/	/
4804	46.20	H	33.95	10.18	34.26	56.07	74	-17.93	PK
4804	35.35	H	33.95	10.18	34.26	45.22	54	-8.78	AV
7206	/	/	/	/	/	/	/	/	/
9608	/	/	/	/	/	/	/	/	/
Test Mode: TX Mid									
4880	42.09	V	33.93	10.2	34.29	51.93	74	-22.07	PK
4880	33.56	V	33.93	10.2	34.29	43.40	54	-10.60	AV
7320	/	/	/	/	/	/	/	/	/
9760	/	/	/	/	/	/	/	/	/
4880	45.58	H	33.93	10.2	34.29	55.42	74	-18.58	PK
4880	34.97	H	33.93	10.2	34.29	44.81	54	-9.19	AV
7320	/	/	/	/	/	/	/	/	/
9760	/	/	/	/	/	/	/	/	/
Test Mode: TX High									
4960	45.70	V	33.98	10.22	34.25	55.65	74	-18.35	PK
4960	33.03	V	33.98	10.22	34.25	42.98	54	-11.02	AV
7440	/	/	/	/	/	/	/	/	/
9920	/	/	/	/	/	/	/	/	/
4960	41.56	H	33.98	10.22	34.25	51.51	74	-22.49	PK
4960	34.46	H	33.98	10.22	34.25	44.41	54	-9.59	AV
7440	/	/	/	/	/	/	/	/	/
9920	/	/	/	/	/	/	/	/	/
Note: 1, Result = Read level + Antenna factor + cable loss-Amp factor 2, All the other emissions not reported were too low to read and deemed to comply with FCC limit.									

Conducted RF Spurious Emission

Tx. Spurious NVNT BLE 1M 2402MHz Ant1 Ref

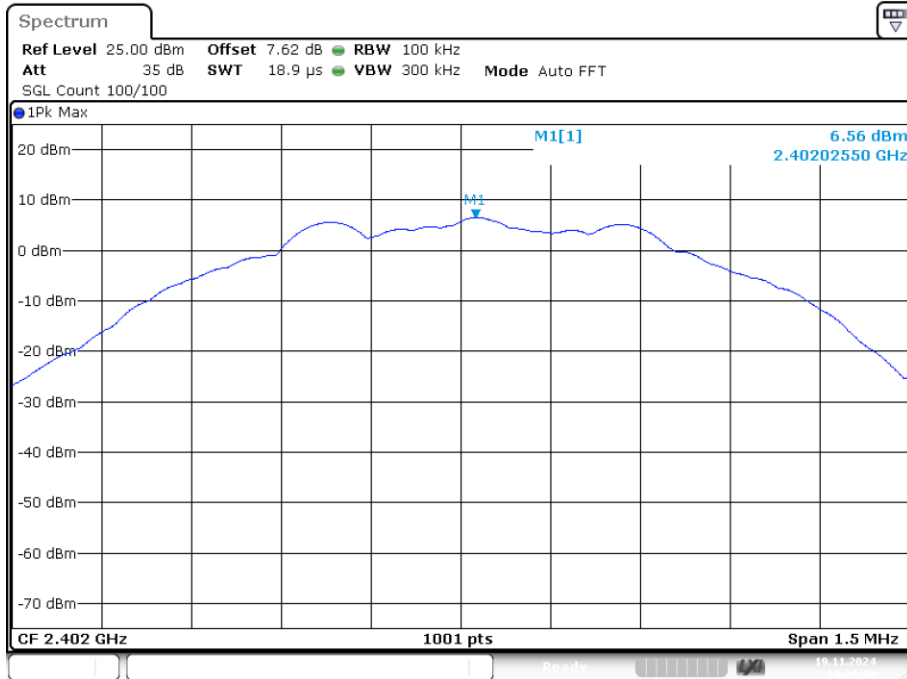

Date: 19.NOV.2024 14:22:20

Tx. Spurious NVNT BLE 1M 2402MHz Ant1 Emission

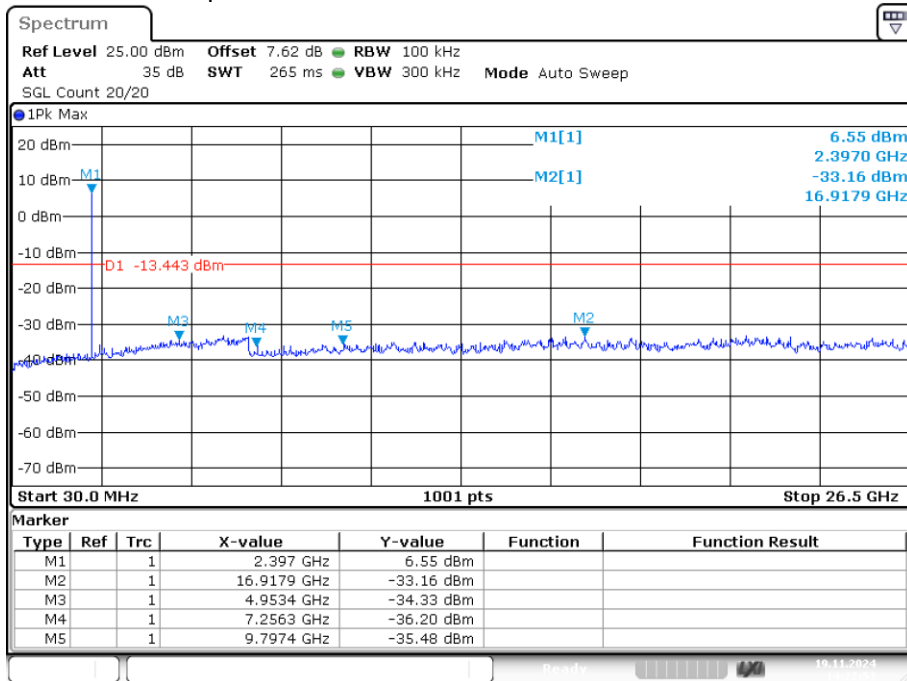

Date: 19.NOV.2024 14:22:53

Tx. Spurious NVNT BLE 1M 2440MHz Ant1 Ref

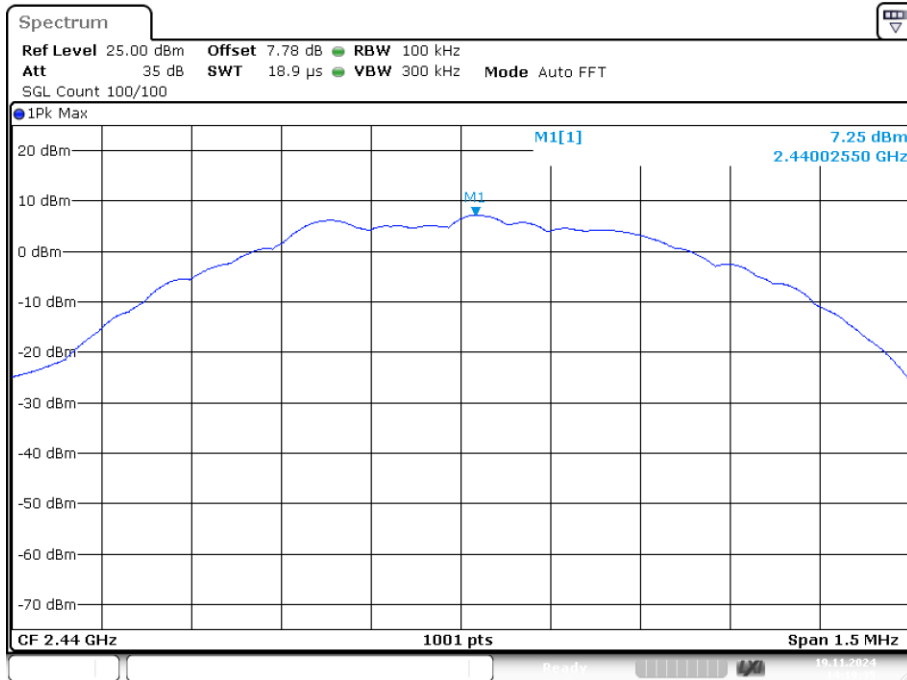

Date: 19.NOV.2024 14:19:35

Tx. Spurious NVNT BLE 1M 2440MHz Ant1 Emission

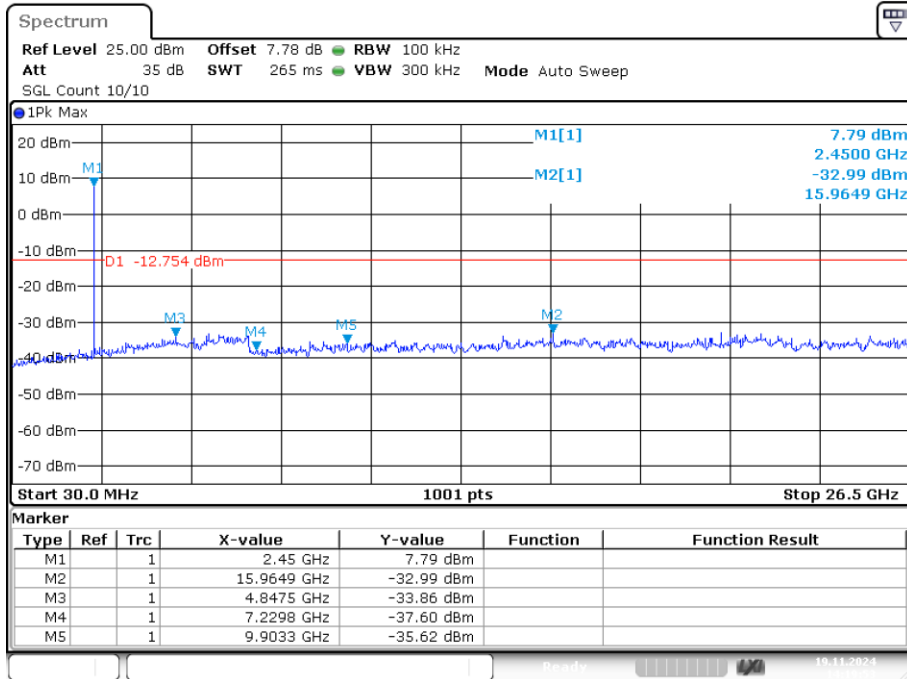

Date: 19.NOV.2024 14:19:53

Tx. Spurious NVNT BLE 1M 2480MHz Ant1 Ref

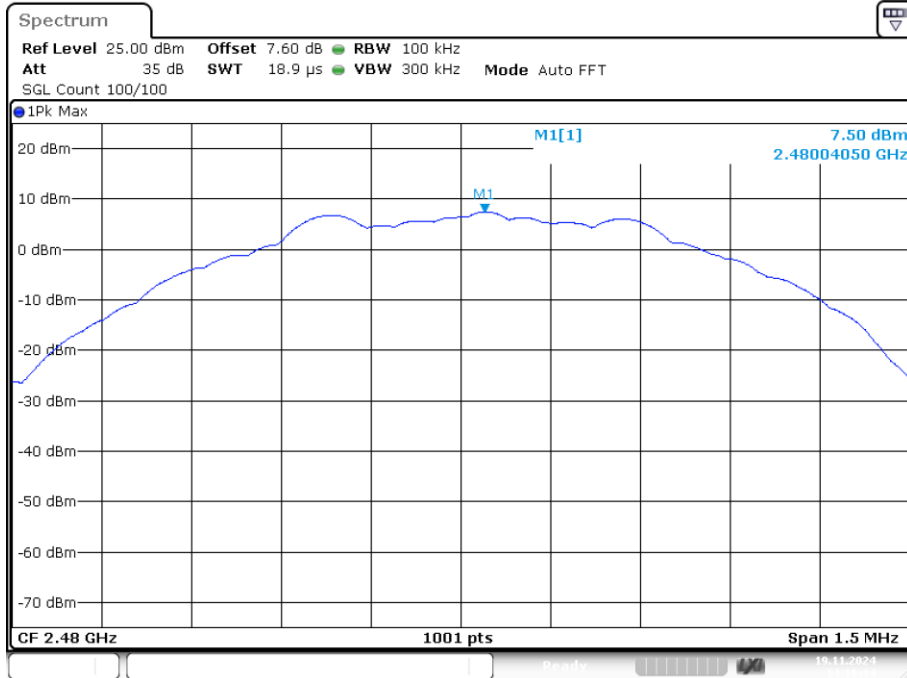

Date: 19.NOV.2024 14:16:14

Tx. Spurious NVNT BLE 1M 2480MHz Ant1 Emission

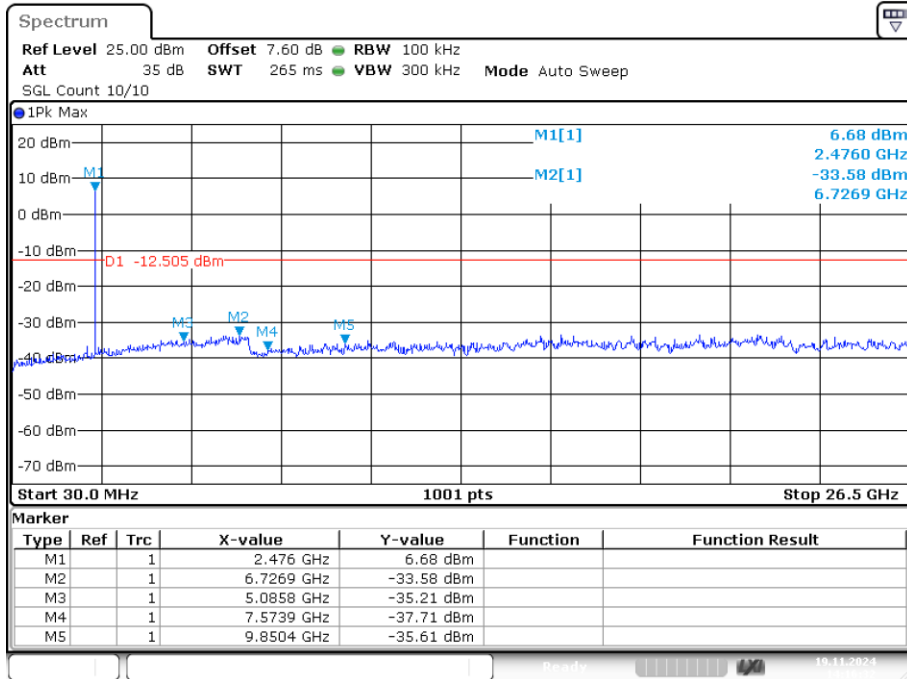

Date: 19.NOV.2024 14:16:32

Tx. Spurious NVNT BLE 2M 2402MHz Ant1 Ref

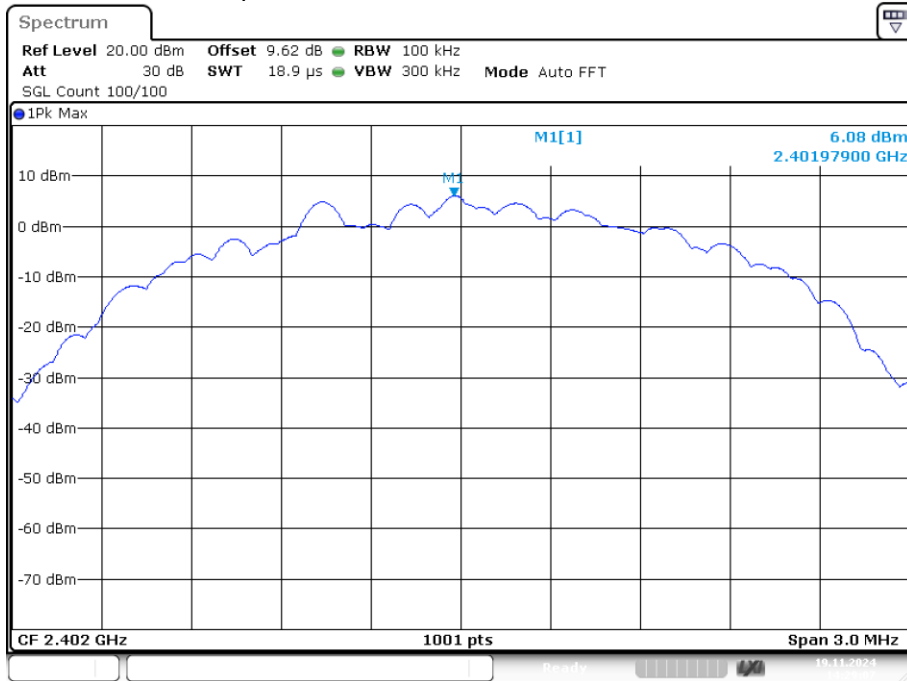

Tx. Spurious NVNT BLE 2M 2402MHz Ant1 Emission

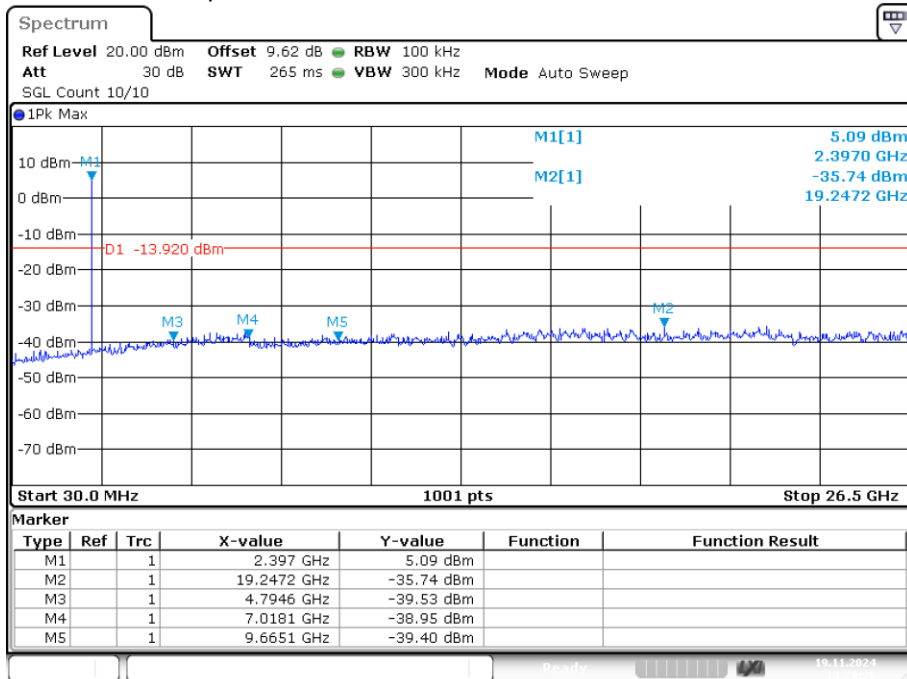

Tx. Spurious NVNT BLE 2M 2440MHz Ant1 Ref

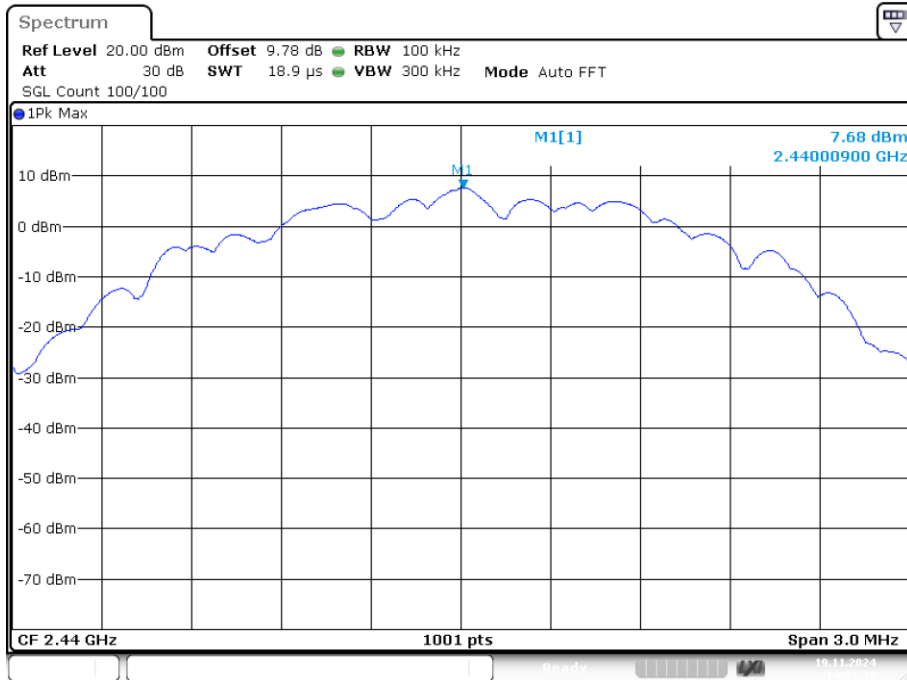

Date: 19.NOV.2024 14:31:30

Tx. Spurious NVNT BLE 2M 2440MHz Ant1 Emission

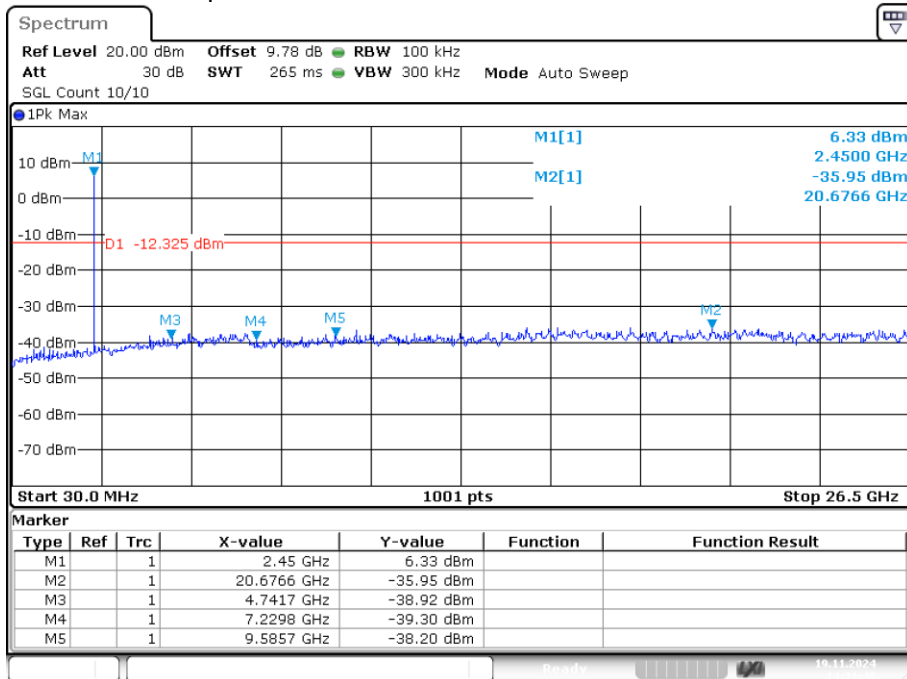

Date: 19.NOV.2024 14:31:48

Tx. Spurious NVNT BLE 2M 2480MHz Ant1 Ref

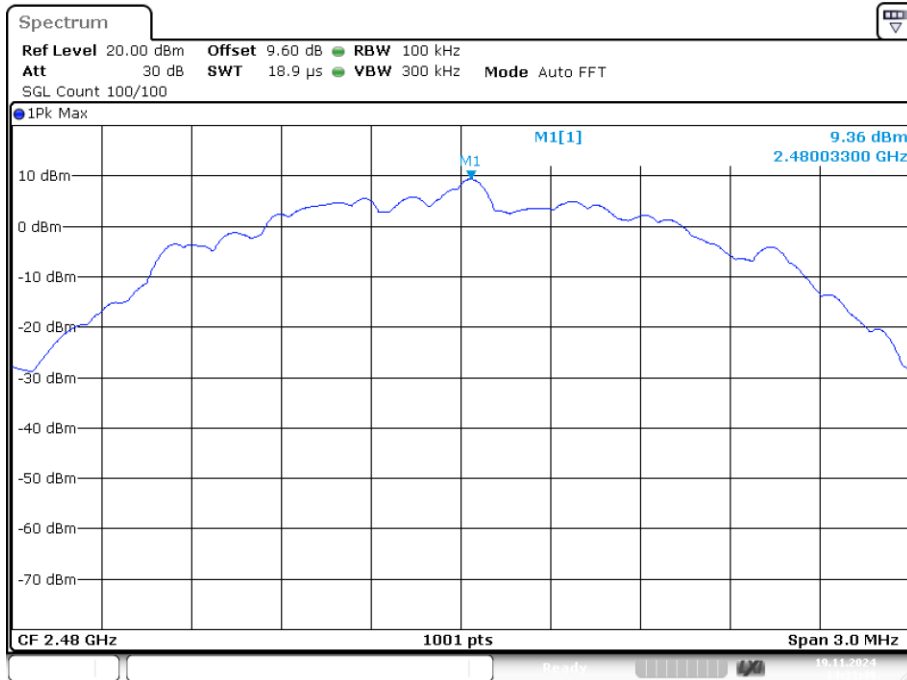

Date: 19.NOV.2024 14:33:49

Tx. Spurious NVNT BLE 2M 2480MHz Ant1 Emission

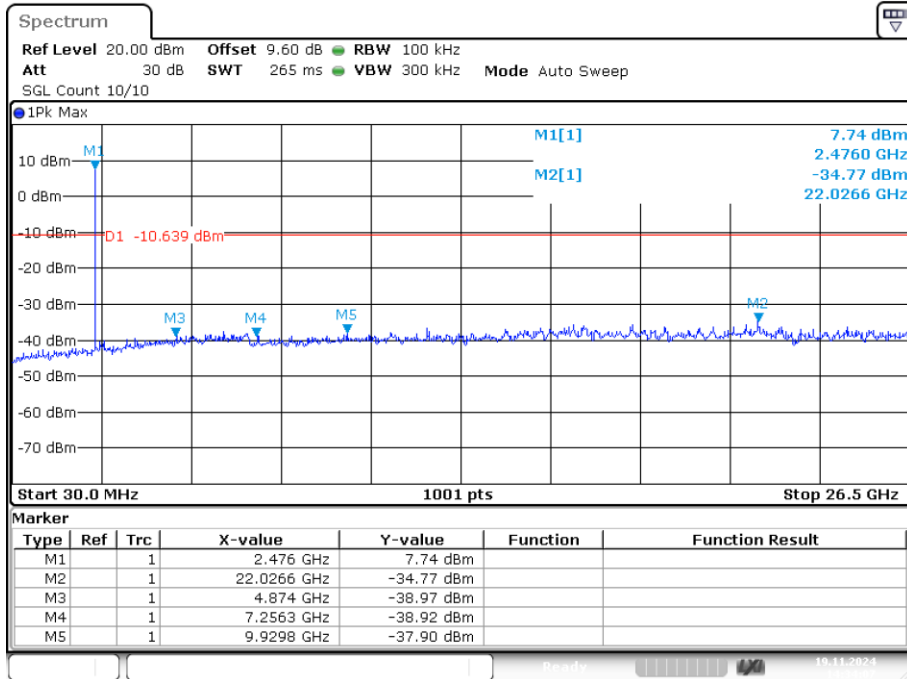

Date: 19.NOV.2024 14:34:07

4. POWER LINE CONDUCTED EMISSION

4.1. Test Limits

Frequency MHz	Limits dB(μ V)	
	Quasi-peak Level	Average Level
0.15 -0.50	66 -56*	56 - 46*
0.50 -5.00	56	46
5.00 -30.00	60	50

Notes: 1. *Decreasing linearly with logarithm of frequency.

2. The lower limit shall apply at the transition frequencies.

3. The limit decreases in line with the logarithm of the frequency in rang of 0.15 to 0.50 MHz.

4.2. Test Procedure

The EUT is put on the plane 0.8m high above the ground by insulating support and is connected to the power mains through a line impedance stabilization network (L.I.S.N.). This provides a 50ohm coupling impedance for the EUT system. Please refer the block diagram of the test setup and photographs. Both sides of AC lines are checked to find out the maximum conducted emission. In order to find the maximum emission levels, the relative positions of equipment and all of the interface cables shall be changed according to ANSI ANSI C63.10:2013 on Conducted Emission Measurement.

The bandwidth of test receiver is set at 9 kHz.

4.3. Test Setup

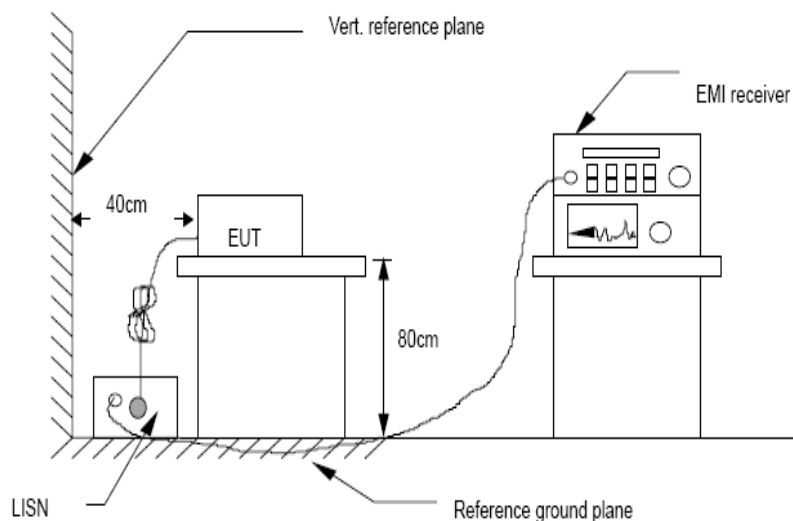

4.4. Test Results

Pass

Line:

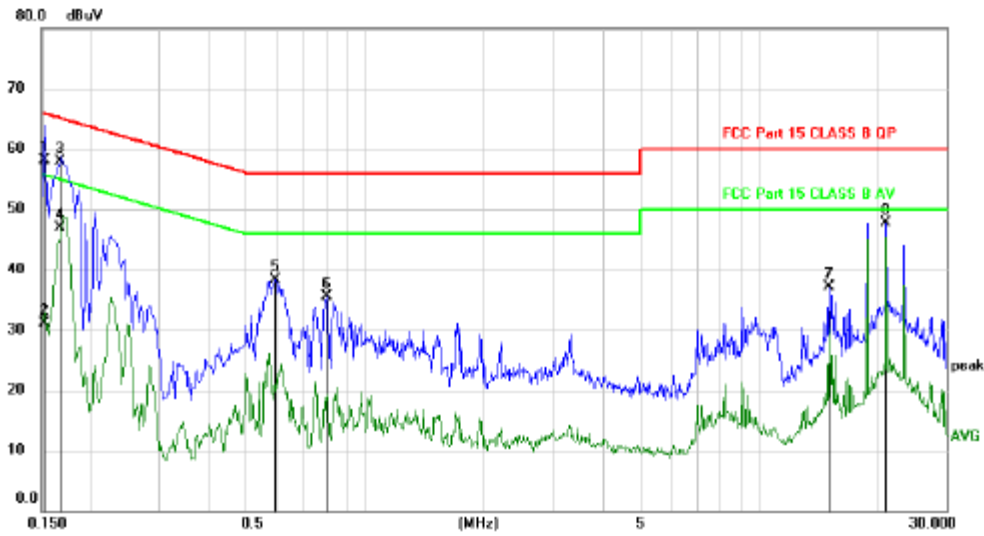

No.	Mk.	Freq. MHz	Reading Level dBuV	Correct Factor dB	Measure- ment dBuV	Limit dBuV	Margin dB	Detector	Comment
1		0.1530	48.20	9.94	58.14	65.84	-7.70	QP	
2		0.1530	21.15	9.94	31.09	55.84	-24.75	AVG	
3	*	0.1680	47.91	9.93	57.84	65.06	-7.22	QP	
4		0.1680	37.06	9.93	46.99	55.06	-8.07	AVG	
5		0.5910	28.44	9.92	38.36	56.00	-17.64	peak	
6		0.7980	25.50	9.94	35.44	56.00	-20.56	peak	
7		15.0930	26.76	10.33	37.09	60.00	-22.91	peak	
8		21.1200	37.23	10.47	47.70	60.00	-12.30	peak	

*:Maximum data x:Over limit !:over margin (Reference Only)
 Note: Measurement=Reading Level+Correc Factor. Factor=(LISN or ISN or PLC or Current Probe)Factor+Cable

Neutral:

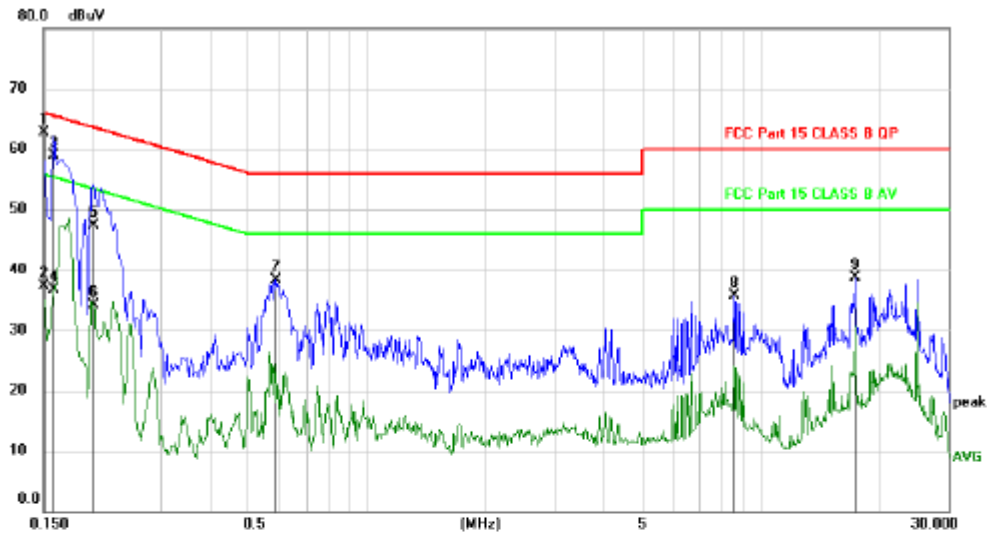

No.	Mk.	Freq. MHz	Reading Level dBuV	Correct Factor dB	Measure- ment dBuV	Limit dBuV	Margin dB	Detector	Comment
1	*	0.1500	52.69	9.94	62.63	66.00	-3.37	QP	
2		0.1500	27.34	9.94	37.28	56.00	-18.72	AVG	
3		0.1590	48.88	9.94	58.82	65.52	-6.70	QP	
4		0.1590	26.77	9.94	36.71	55.52	-18.81	AVG	
5		0.2010	37.29	9.92	47.21	63.57	-16.36	QP	
6		0.2010	24.16	9.92	34.08	53.57	-19.49	AVG	
7		0.5880	28.33	9.92	38.25	56.00	-17.75	peak	
8		8.5649	25.52	10.17	35.69	60.00	-24.31	peak	
9		17.3580	28.37	10.40	38.77	60.00	-21.23	peak	

*:Maximum data x:Over limit !:over margin (Reference Only)
 Note: Measurement=Reading Level+Correc Factor. Factor=(LISN or ISN or PLC or Current Probe)Factor+Cable

Note: This report shows the worst-case testing mode, with TX 2440MHz being the worst-case mode. (1Mbps)

5. CONDUCTED MAXIMUM OUTPUT POWER

5.1. Test limits

Please refer section RSS-247 & 15.247.

5.2. Test Procedure

Details see the KDB558074 D01 Meas Guidance v05r02

5.2.1 Place the EUT on the table and set it in transmitting mode.

5.2.2 Measure out each mode and each bands peak output power of EUT.

Note: The cable loss and attenuator loss were offset into measure device as amplitude offset.

5.3. Test Setup

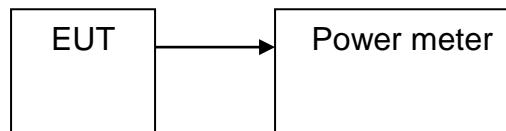

5.4. Test Results

Mode	Frequency (MHz)	Antenna	Conducted Power (dBm)	Limit (dBm)	Verdict
BLE 1M	2402	Ant1	6.808	30	Pass
BLE 1M	2440	Ant1	7.388	30	Pass
BLE 1M	2480	Ant1	7.883	30	Pass

Mode	Frequency (MHz)	Antenna	Conducted Power (dBm)	Limit (dBm)	Verdict
BLE 2M	2402	Ant1	8.453	30	Pass
BLE 2M	2440	Ant1	9.363	30	Pass
BLE 2M	2480	Ant1	9.737	30	Pass

6. PEAK POWER SPECTRAL DENSITY

6.1. Test limits

6.1.1 Please refer section RSS-247 & 15.247.

6.1.2 For direct sequence systems, the peak power spectral density conducted from the intentional radiator to the antenna shall not be greater than 8dBm in any 3kHz band during any time interval of continuous transmission.

6.1.3 The direct sequence operating of the hybrid system, with the frequency hopping operation turned off, shall comply with the power density requirements of paragraph (d) of this section.

6.2. Test Procedure

Details see the KDB558074 D01 Meas Guidance v05r02

6.2.1 Place the EUT on the table and set it in transmitting mode.

6.2.2 Remove the antenna from the EUT and then connect a low loss RF cable from the antenna port to the spectrum analyzer.

6.2.3 Set the spectrum analyzer as RBW = 3kHz(Set the RBW to: $3\text{ kHz} \leq \text{RBW} \leq 100\text{ kHz}$.), VBW = 10kHz(Set the VBW $\geq 3 \times \text{RBW}$), span $\geq 1.5 \times \text{DTS bandwidth}$., detail see the test plot.

6.2.4 Record the max reading.

6.2.5 Repeat the above procedure until the measurements for all frequencies are completed.

6.3. Test Setup

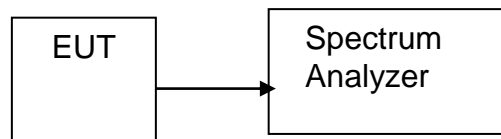

6.4. Test Results

Condition	Mode	Frequency (MHz)	Antenna	Max PSD (dBm)	Limit (dBm)	Verdict
NVNT	1M	2402	Ant1	-8.92	8	Pass
NVNT	1M	2440	Ant1	-7.516	8	Pass
NVNT	1M	2480	Ant1	-6.227	8	Pass

PSD NVNT BLE 1M 2402MHz Ant1

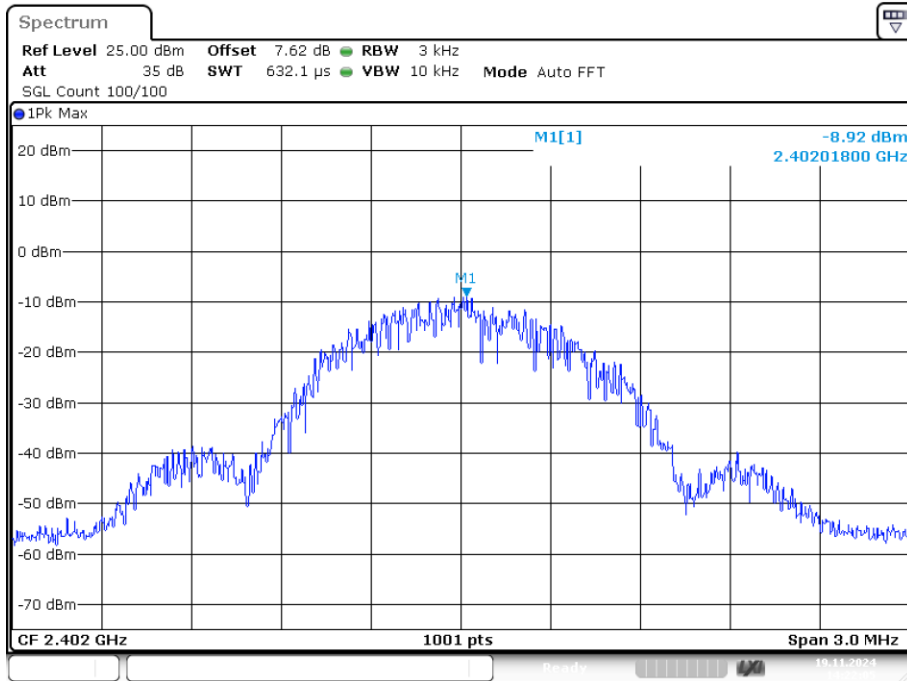

Date: 19.NOV.2024 14:22:06

PSD NVNT BLE 1M 2440MHz Ant1

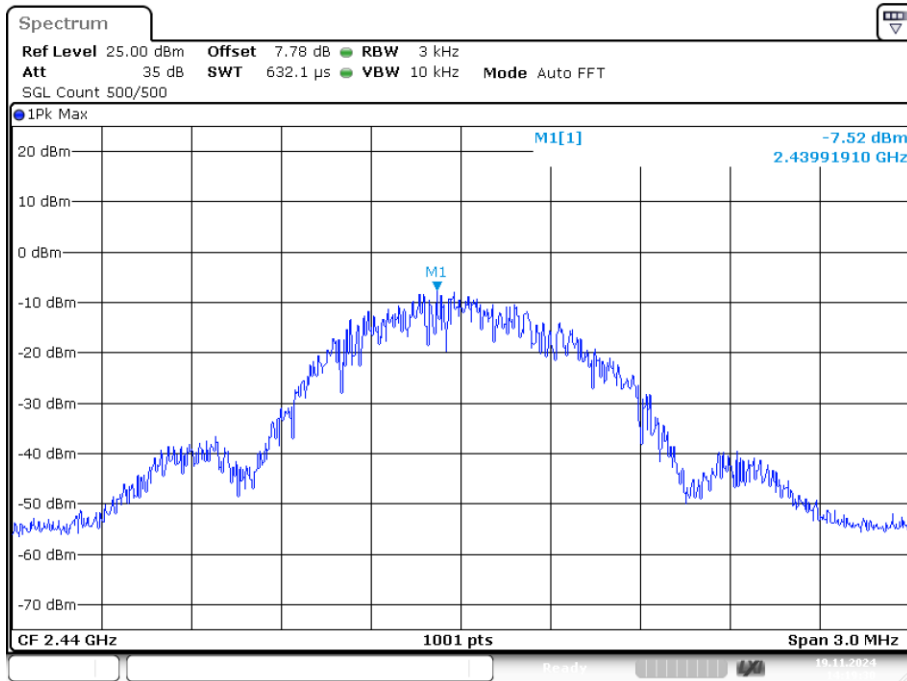

Date: 19.NOV.2024 14:19:30

PSD NVNT BLE 1M 2480MHz Ant1

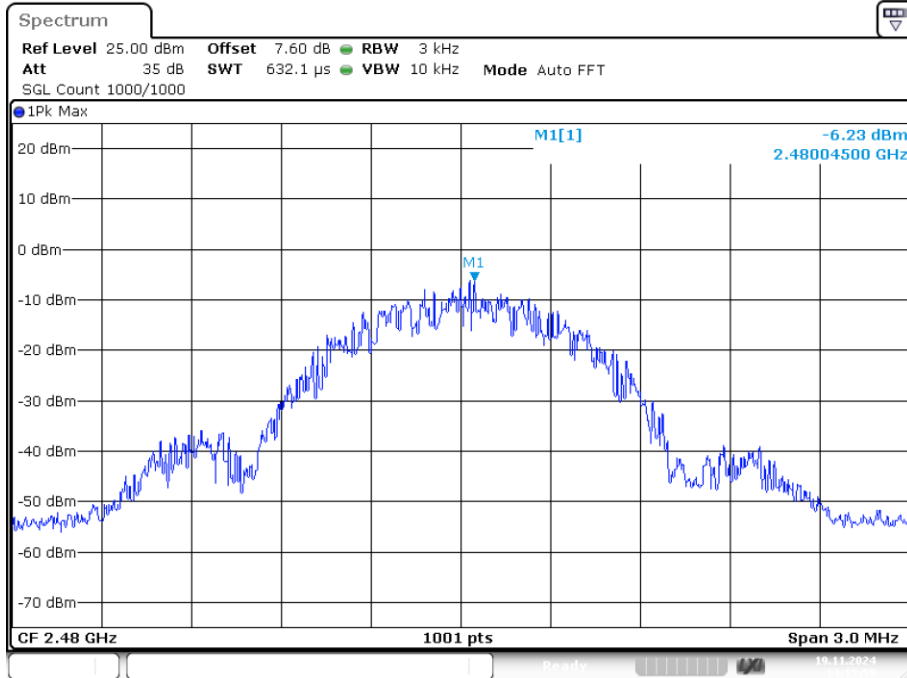

Date: 19.NOV.2024 14:15:59

Condition	Mode	Frequency (MHz)	Antenna	Max PSD (dBm)	Limit (dBm)	Verdict
NVNT	BLE 2M	2402	Ant1	-7.825	8	Pass
NVNT	BLE 2M	2440	Ant1	-7.192	8	Pass
NVNT	BLE 2M	2480	Ant1	-7.774	8	Pass

PSD NVNT BLE 2M 2402MHz Ant1

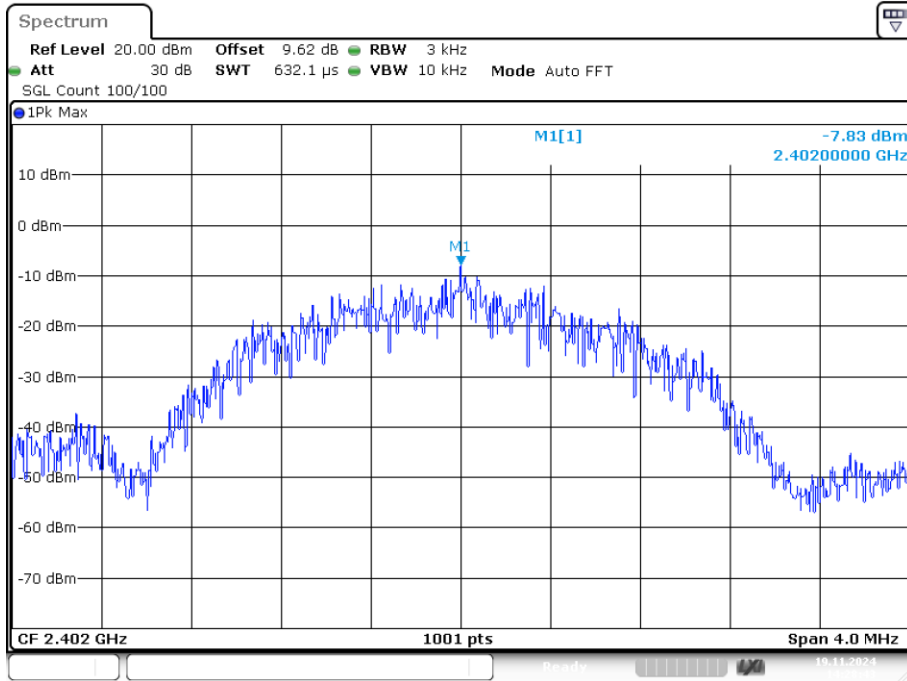

Date: 19.NOV.2024 14:28:43

PSD NVNT BLE 2M 2440MHz Ant1

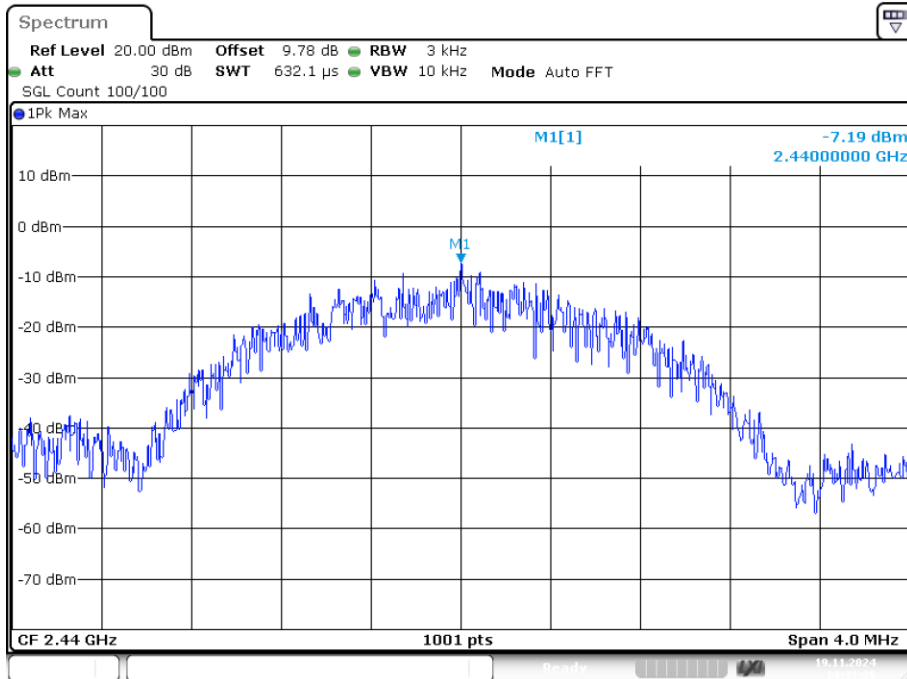

Date: 19.NOV.2024 14:31:25

PSD NVNT BLE 2M 2480MHz Ant1

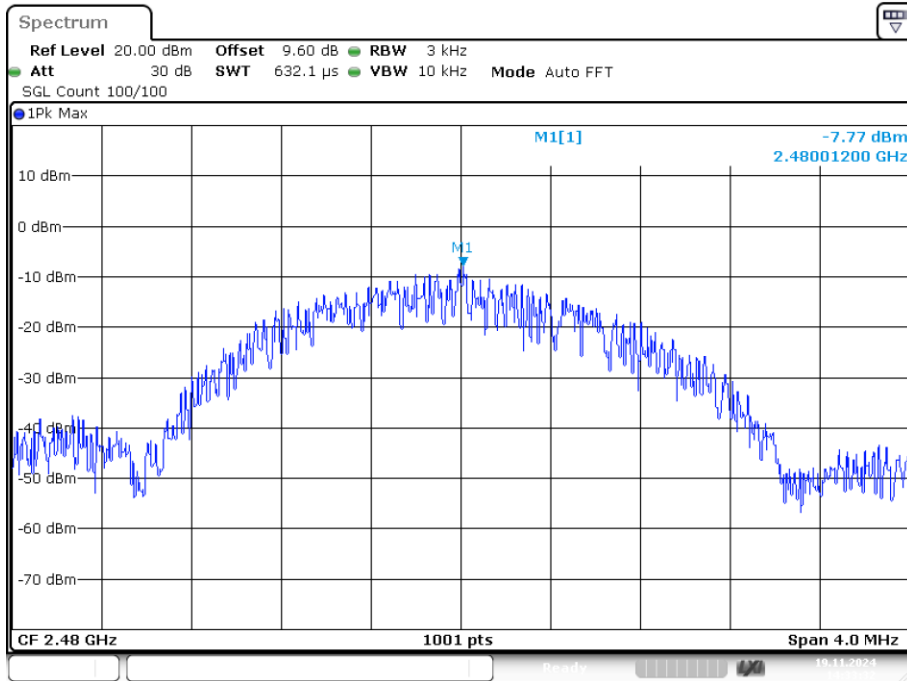

Date: 19.NOV.2024 14:33:32

7. BANDWIDTH

7.1. Test limits

Please refer section RSS-247 & 15.247

For direct sequence systems, the minimum 6dB bandwidth shall be at least 500 kHz.

7.2. Test Procedure

Details see the KDB558074 D01 Meas Guidance v05r02

- a) The bandwidth is measured at an amplitude level reduced 6dB from the reference level. The reference level is the level of the highest amplitude signal observed from the transmitter at the fundamental frequency. Once the reference level is established, the equipment is conditioned with typical modulating signal to produce the worst-case (i.e. the widest) bandwidth.
- b) The test receiver set $RBW = 1-5\%BW$, $VBW \geq 3*RBW$, Sweep time set auto, detail see the test plot for 99% Bandwidth.
- c) The test receiver set $RBW = 100kHz$, $VBW \geq 3*RBW = 300kHz$, Sweep time set auto, detail see the test plot for 6dB Bandwidth.

7.3. Test Setup

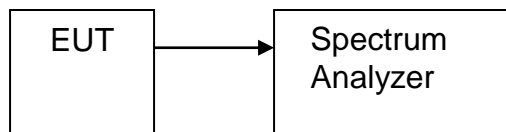

7.4. Test Results

-6dB Bandwidth

Condition	Mode	Frequency (MHz)	Antenna	-6 dB Bandwidth (MHz)	Limit -6 dB Bandwidth (MHz)	Verdict
NVNT	1M	2402	Ant1	0.655	0.5	Pass
NVNT	1M	2440	Ant1	0.658	0.5	Pass
NVNT	1M	2480	Ant1	0.653	0.5	Pass

-6dB Bandwidth NVNT BLE 1M 2402MHz Ant1

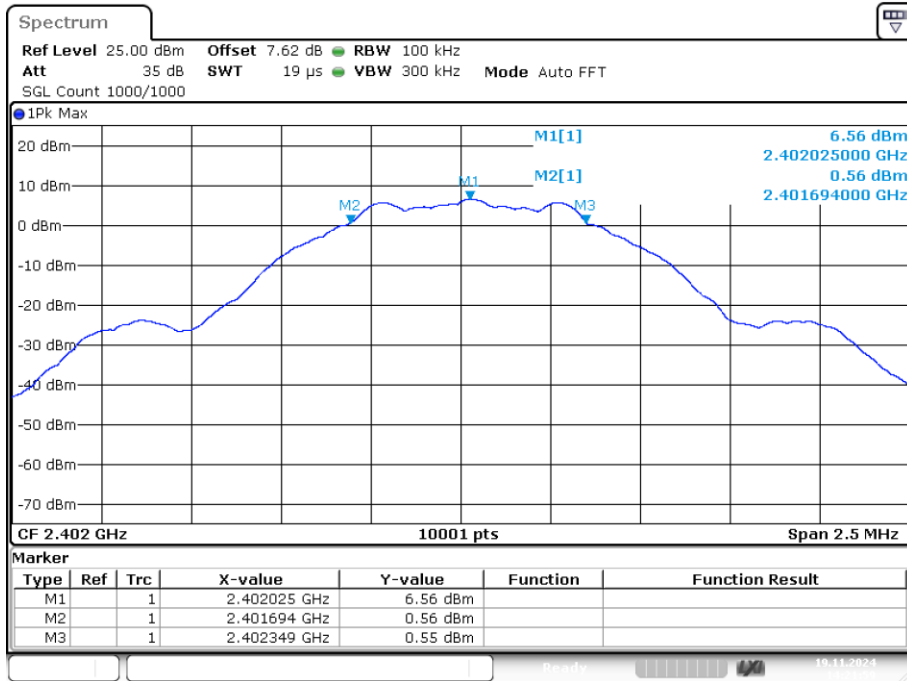

Date: 19.NOV.2024 14:21:59

-6dB Bandwidth NVNT BLE 1M 2440MHz Ant1

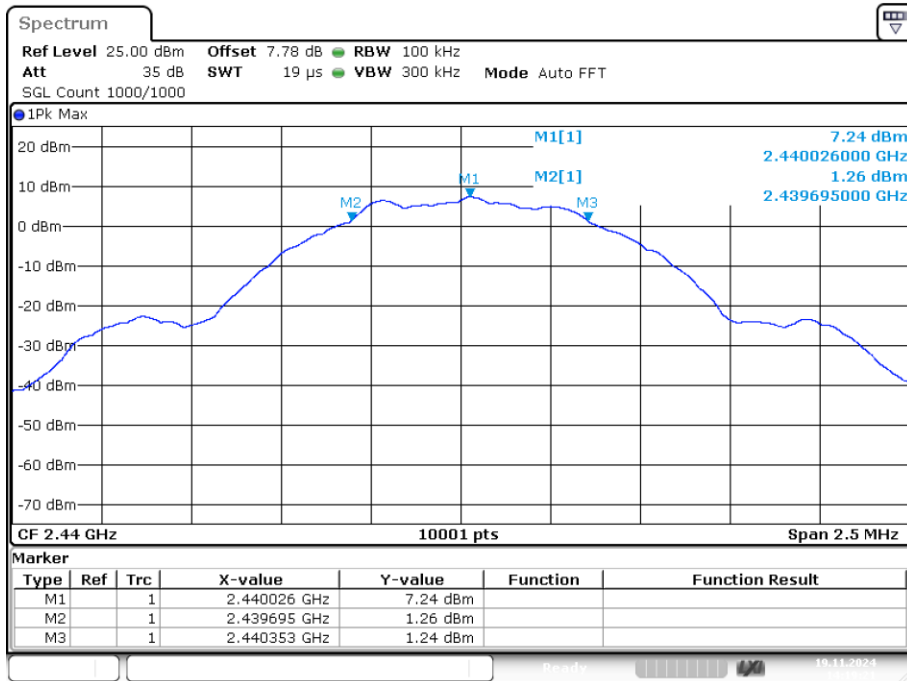

Date: 19.NOV.2024 14:19:21

-6dB Bandwidth NVNT BLE 1M 2480MHz Ant1

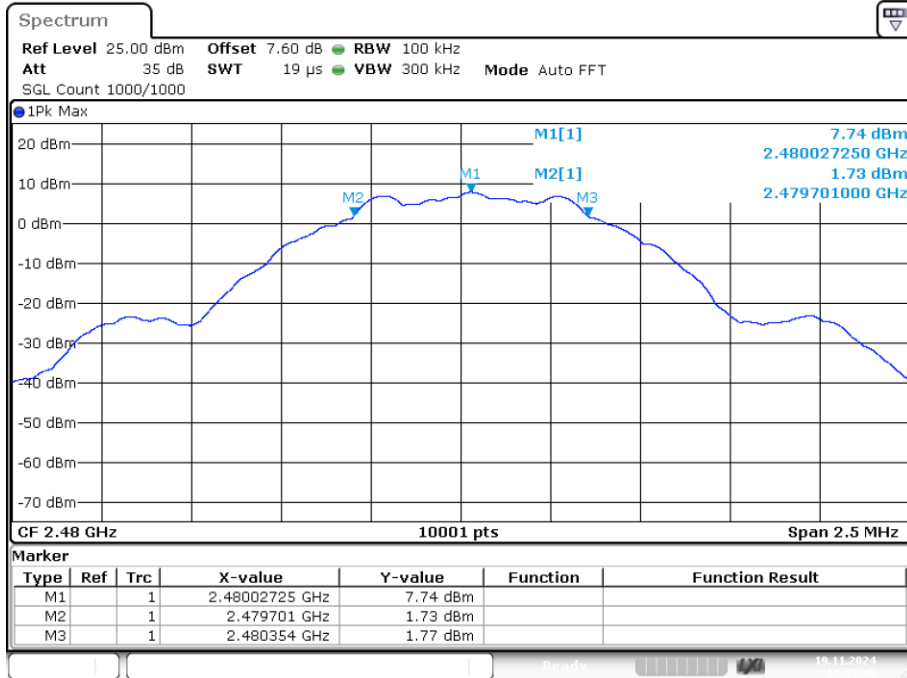

Date: 19.NOV.2024 14:15:47

Occupied Channel Bandwidth

Condition	Mode	Frequency (MHz)	Antenna	99% OBW (MHz)
NVNT	BLE 1M	2402	Ant1	1.016
NVNT	BLE 1M	2440	Ant1	1.031
NVNT	BLE 1M	2480	Ant1	1.034

OBW NVNT BLE 1M 2402MHz Ant1

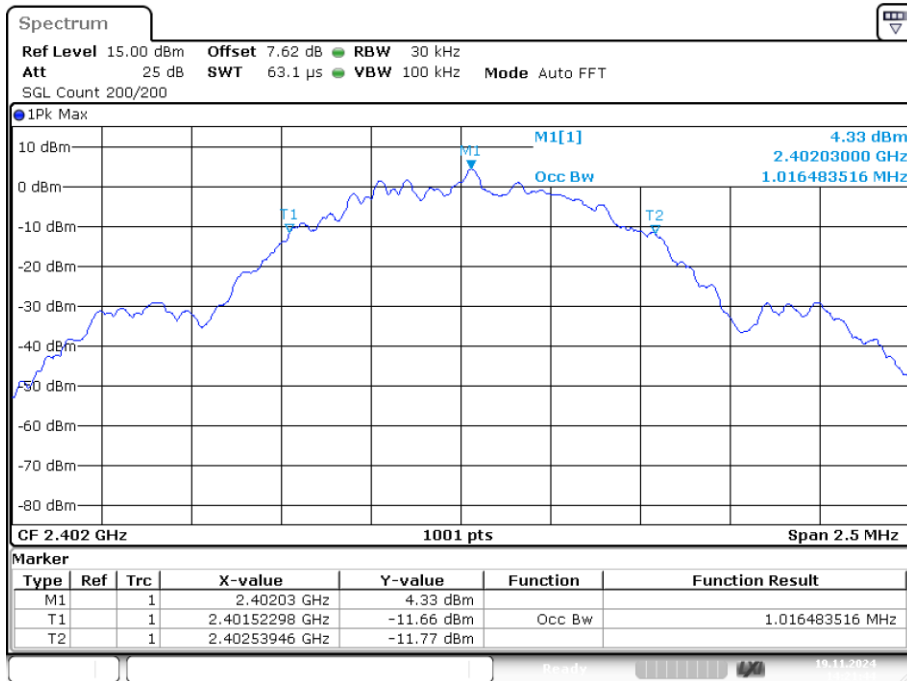

Date: 19.NOV.2024 14:21:44

OBW NVNT BLE 1M 2440MHz Ant1

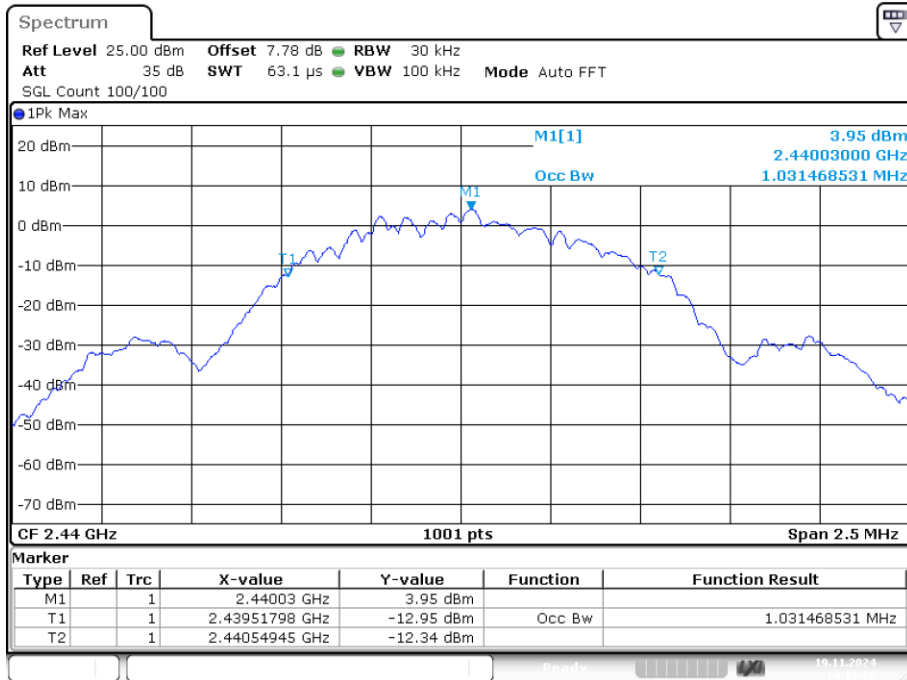

Date: 19.NOV.2024 14:19:05

OBW NVNT BLE 1M 2480MHz Ant1

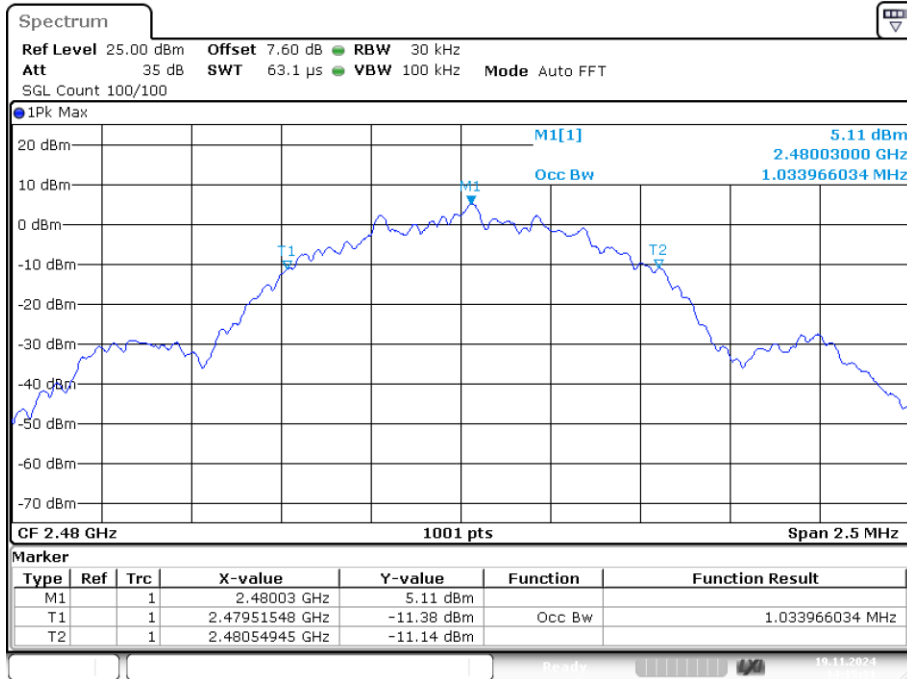

Date: 19.NOV.2024 14:15:31

-6dB Bandwidth

Condition	Mode	Frequency (MHz)	Antenna	-6 dB Bandwidth (MHz)	Limit -6 dB Bandwidth (MHz)	Verdict
NVNT	BLE 2M	2402	Ant1	1.094	0.5	Pass
NVNT	BLE 2M	2440	Ant1	1.077	0.5	Pass
NVNT	BLE 2M	2480	Ant1	0.977	0.5	Pass

-6dB Bandwidth NVNT BLE 2M 2402MHz Ant1

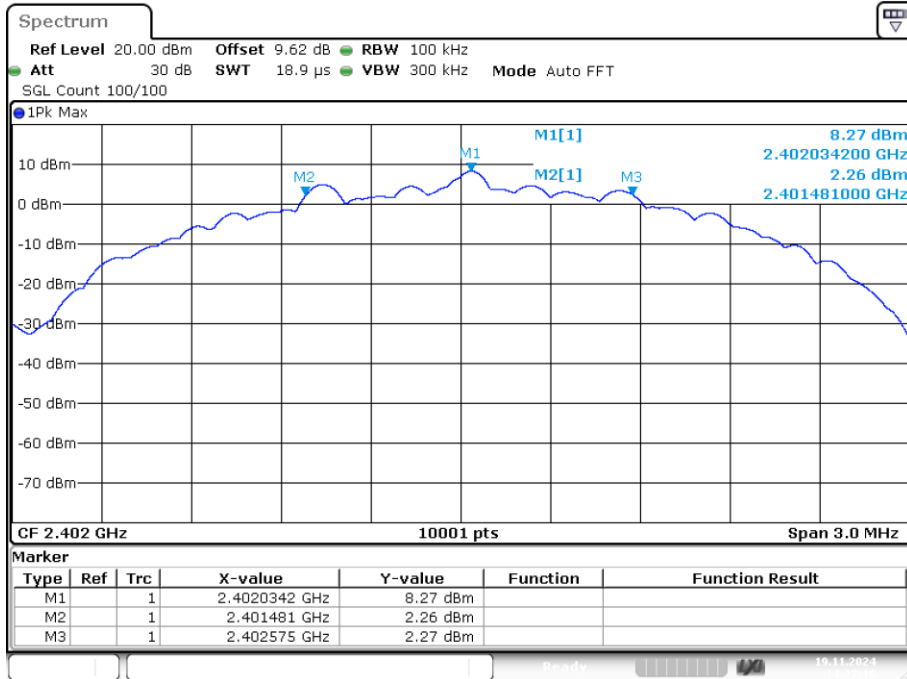

Date: 19.NOV.2024 14:27:17

-6dB Bandwidth NVNT BLE 2M 2440MHz Ant1

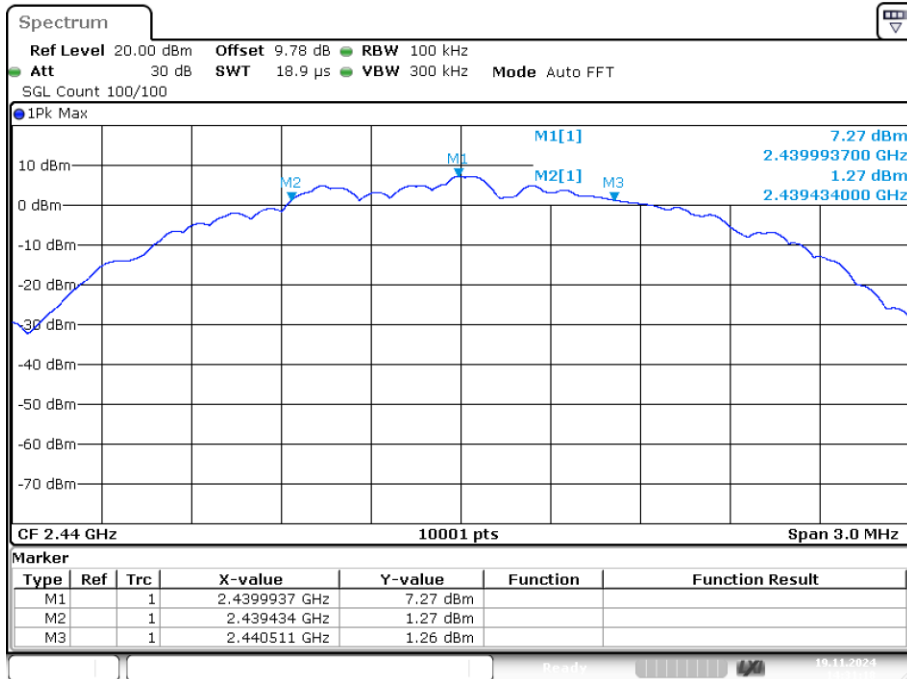

Date: 19.NOV.2024 14:31:18

-6dB Bandwidth NVNT BLE 2M 2480MHz Ant1

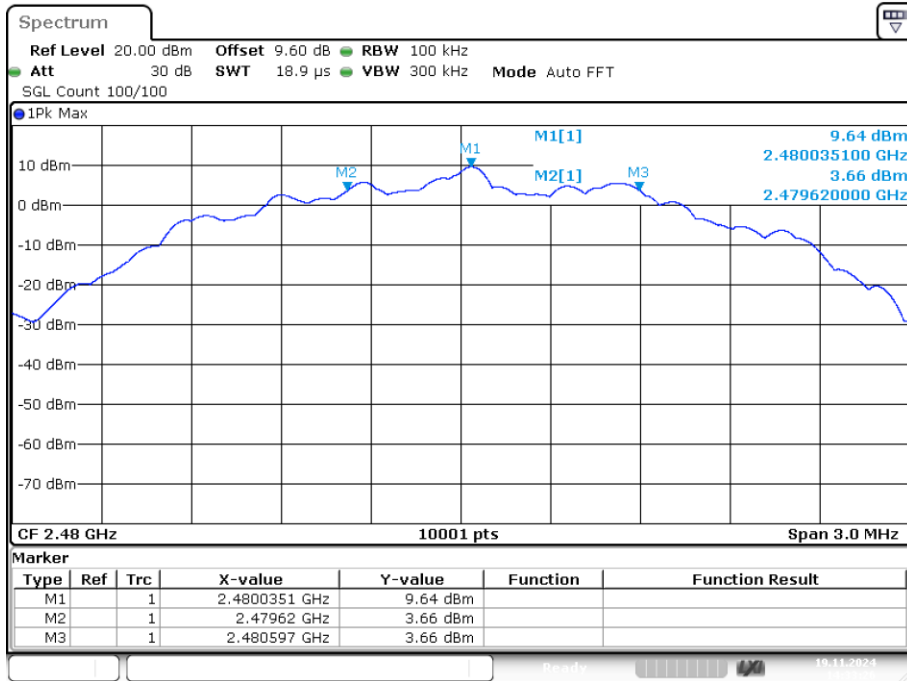

Date: 19.NOV.2024 14:33:25

Occupied Channel Bandwidth

Condition	Mode	Frequency (MHz)	Antenna	99% OBW (MHz)
NVNT	BLE 2M	2402	Ant1	1.981
NVNT	BLE 2M	2440	Ant1	2.011
NVNT	BLE 2M	2480	Ant1	1.984

OBW NVNT BLE 2M 2402MHz Ant1

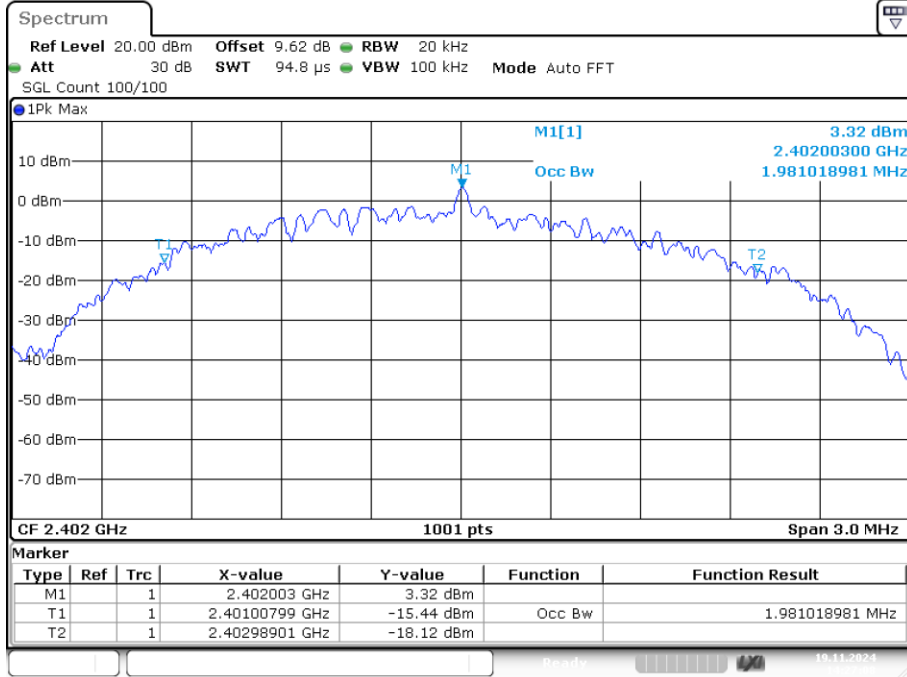

Date: 19.NOV.2024 14:27:09

OBW NVNT BLE 2M 2440MHz Ant1

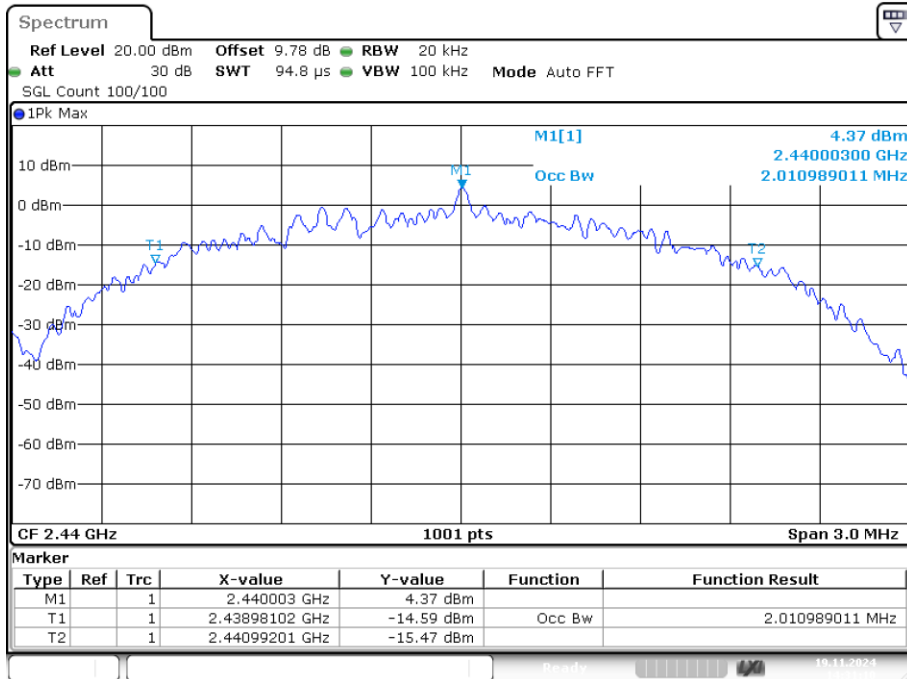

Date: 19.NOV.2024 14:31:10

OBW NVNT BLE 2M 2480MHz Ant1

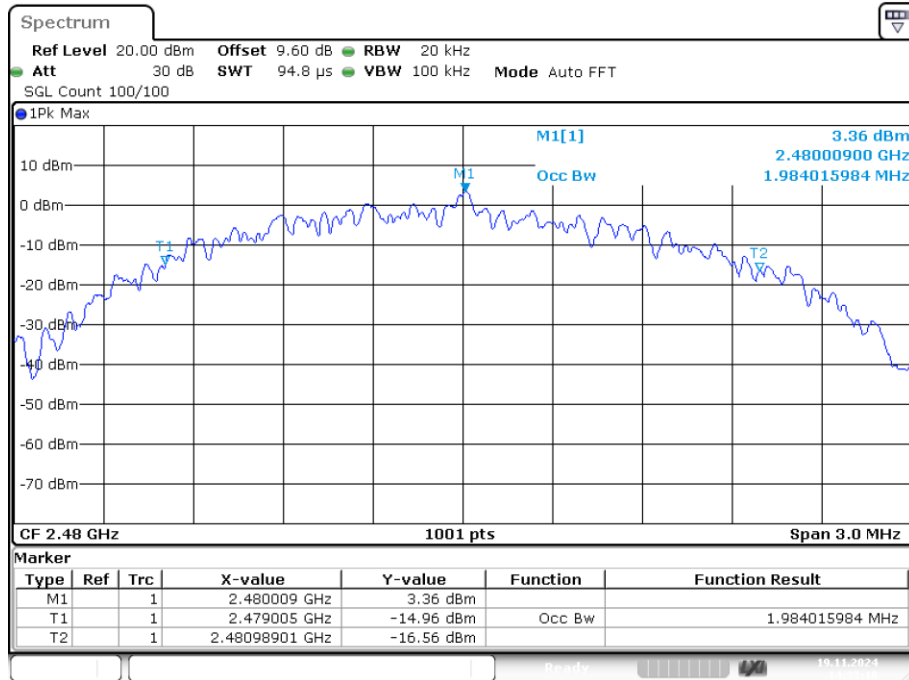

Date: 19.NOV.2024 14:33:17

8. BAND EDGE CHECK

8.1. Test limits

Please refer section RSS-GEN&15.247.

8.2. Test Procedure

Details see the KDB558074 D01 Meas Guidance v05r02

8.2.1 Put the EUT on a 1.5m high table, power on the EUT. Emissions were scanned and measured rotating the EUT to 360 degrees, Find the maximum Emission

8.2.2 Check the spurious emissions out of band.

8.2.3 RBW 1MHz , VBW 3MHz , peak detector for peak value , RBW 1MHz , VBW 3MHz , RMS detector for AV value.

8.3. Test Setup

Same as 3.3 above 1GHz.

8.4. Test Results

Band Edge NVNT BLE 1M 2402MHz Ant1 Ref

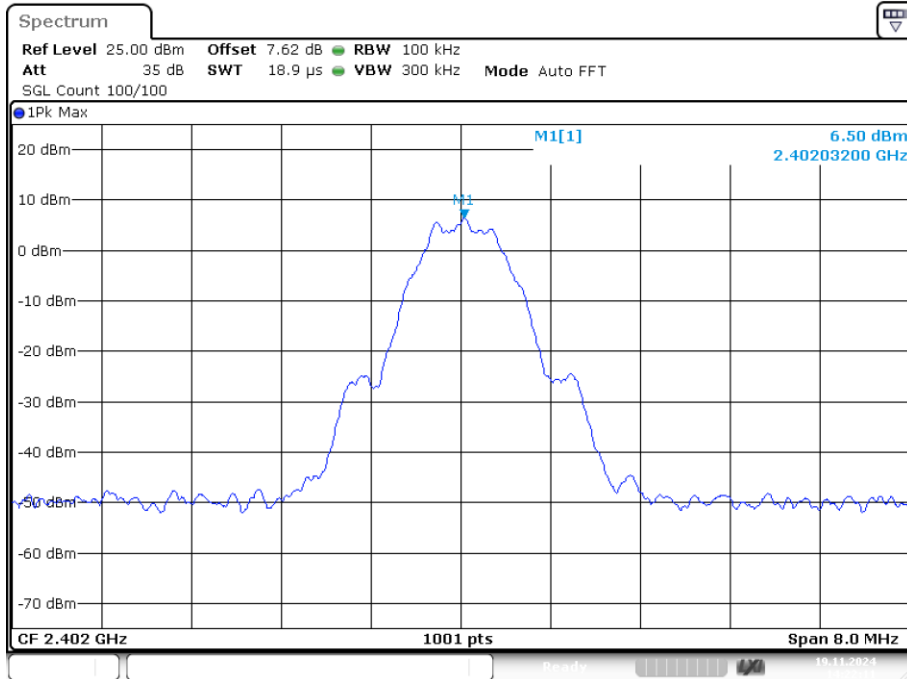

Date: 19.NOV.2024 14:22:11

Band Edge NVNT BLE 1M 2402MHz Ant1 Emission

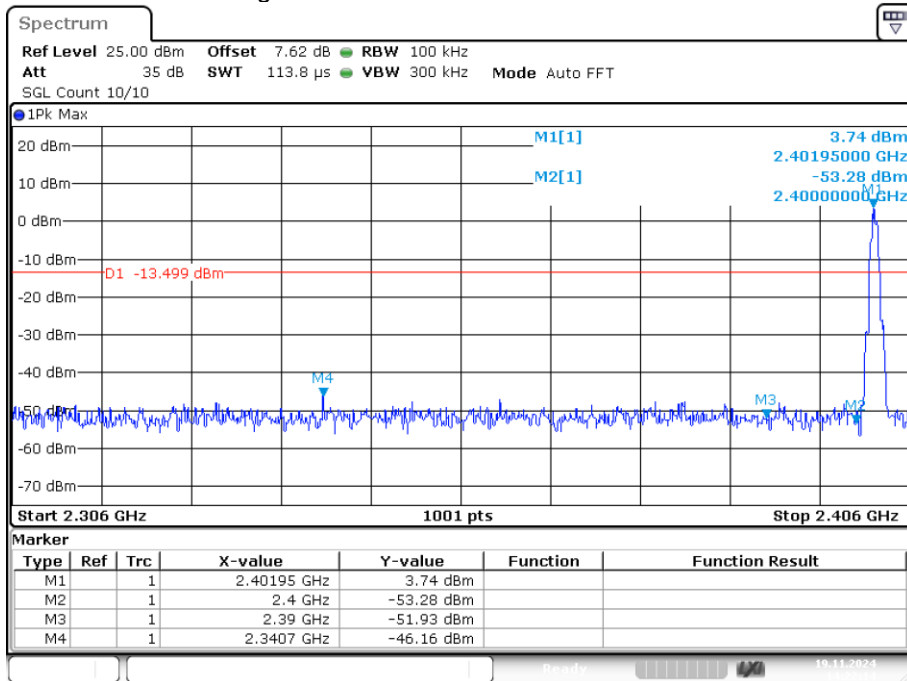

Date: 19.NOV.2024 14:22:14

Band Edge NVNT BLE 1M 2480MHz Ant1 Ref

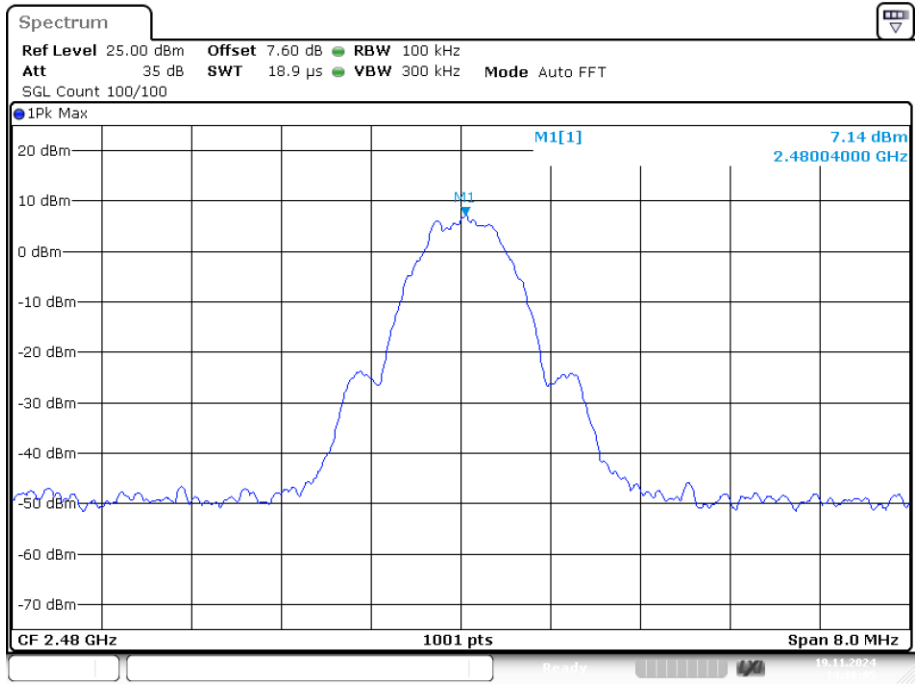

Date: 19.NOV.2024 14:16:04

Band Edge NVNT BLE 1M 2480MHz Ant1 Emission

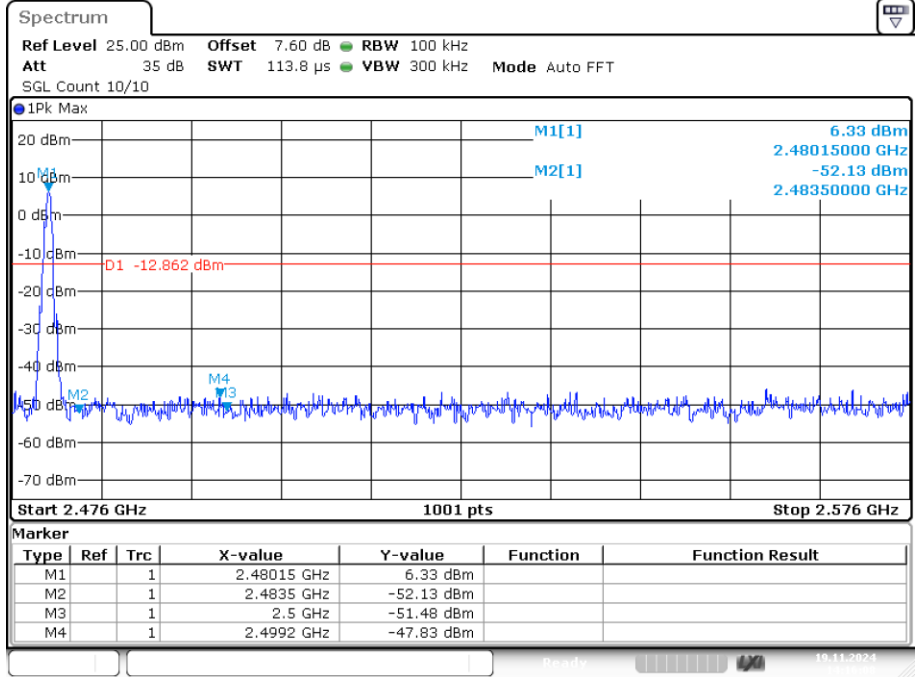

Date: 19.NOV.2024 14:16:08

GFSK 1M Mode:

Test channel: Lowest channel

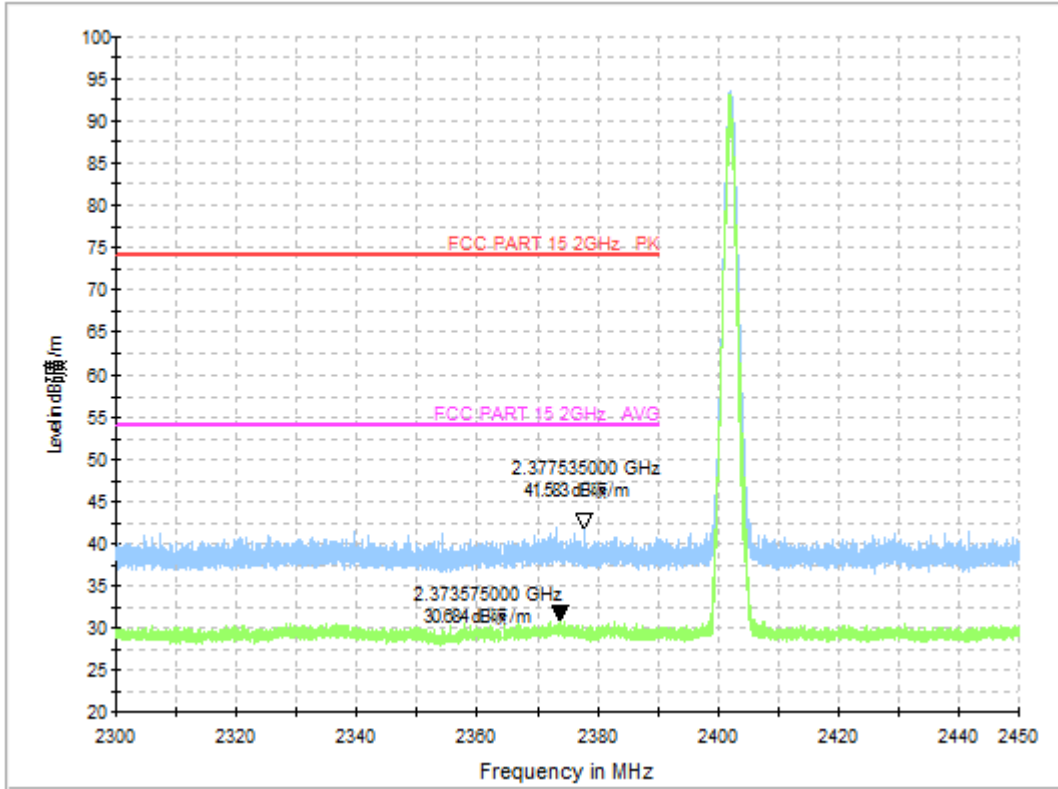

Test channel: Highest channel

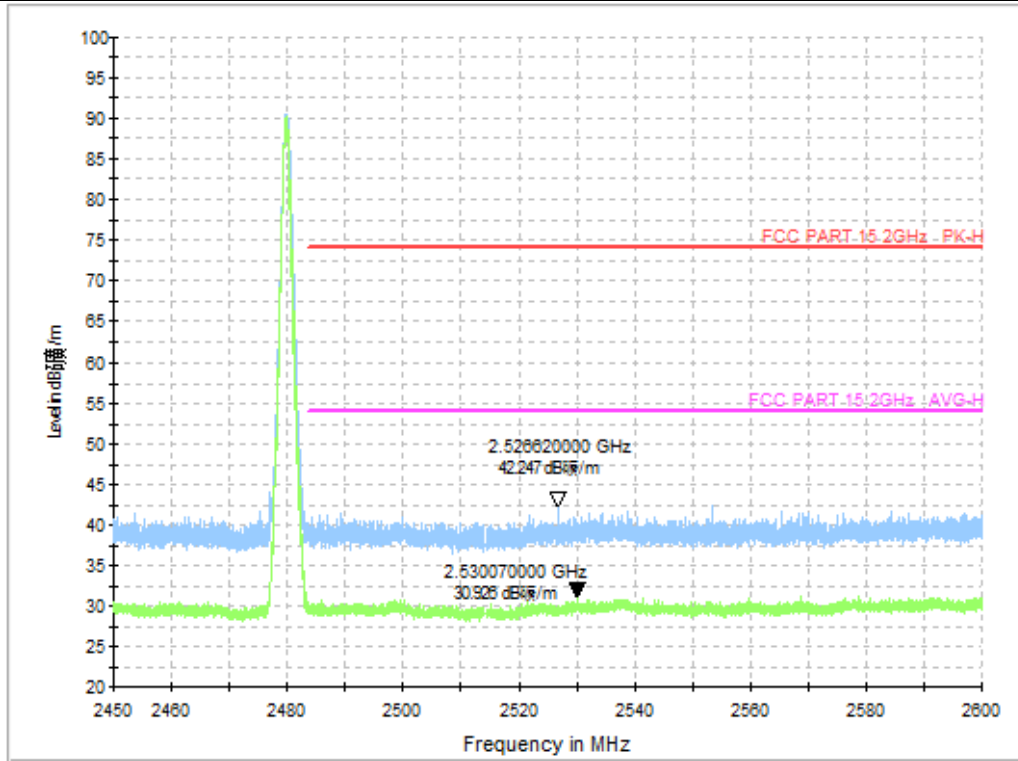

Band Edge NVNT BLE 2M 2402MHz Ant1 Ref



Band Edge NVNT BLE 2M 2402MHz Ant1 Emission

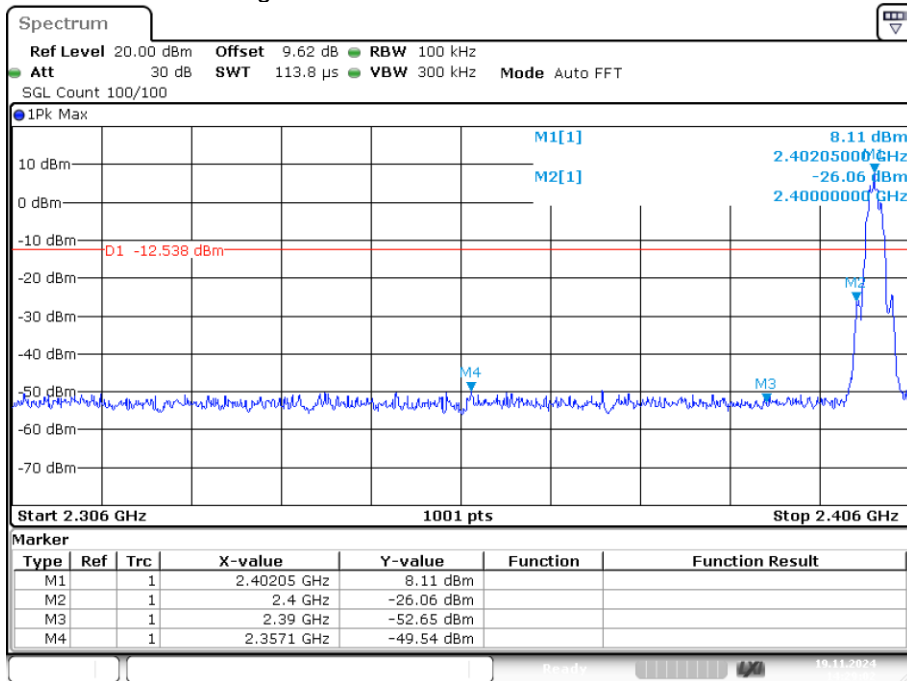

Band Edge NVNT BLE 2M 2480MHz Ant1 Ref

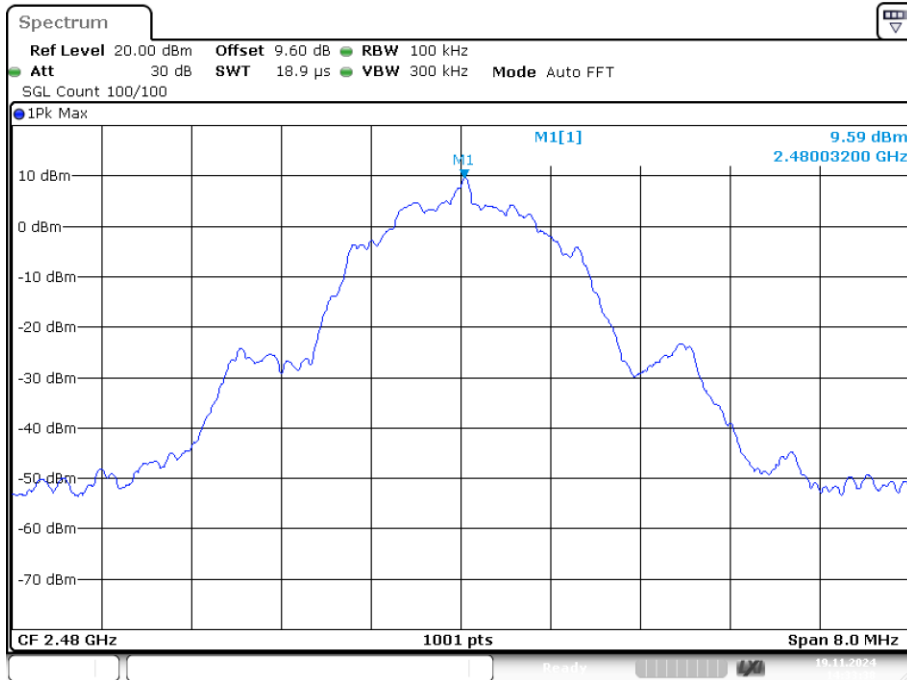

Date: 19.NOV.2024 14:33:37

Band Edge NVNT BLE 2M 2480MHz Ant1 Emission

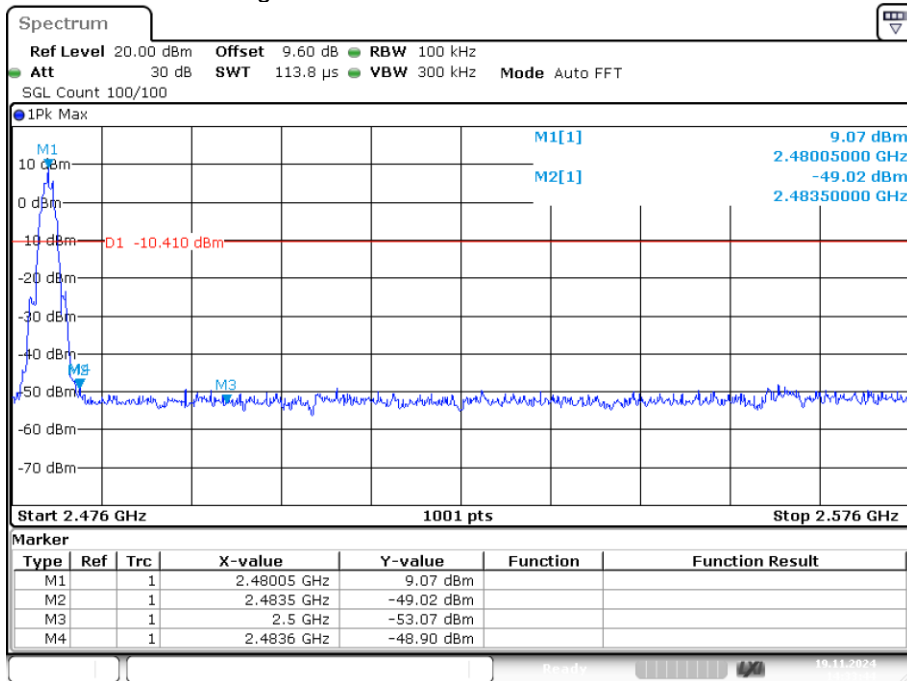

Date: 19.NOV.2024 14:33:43

GFSK 2M Mode:

Test channel: Lowest channel

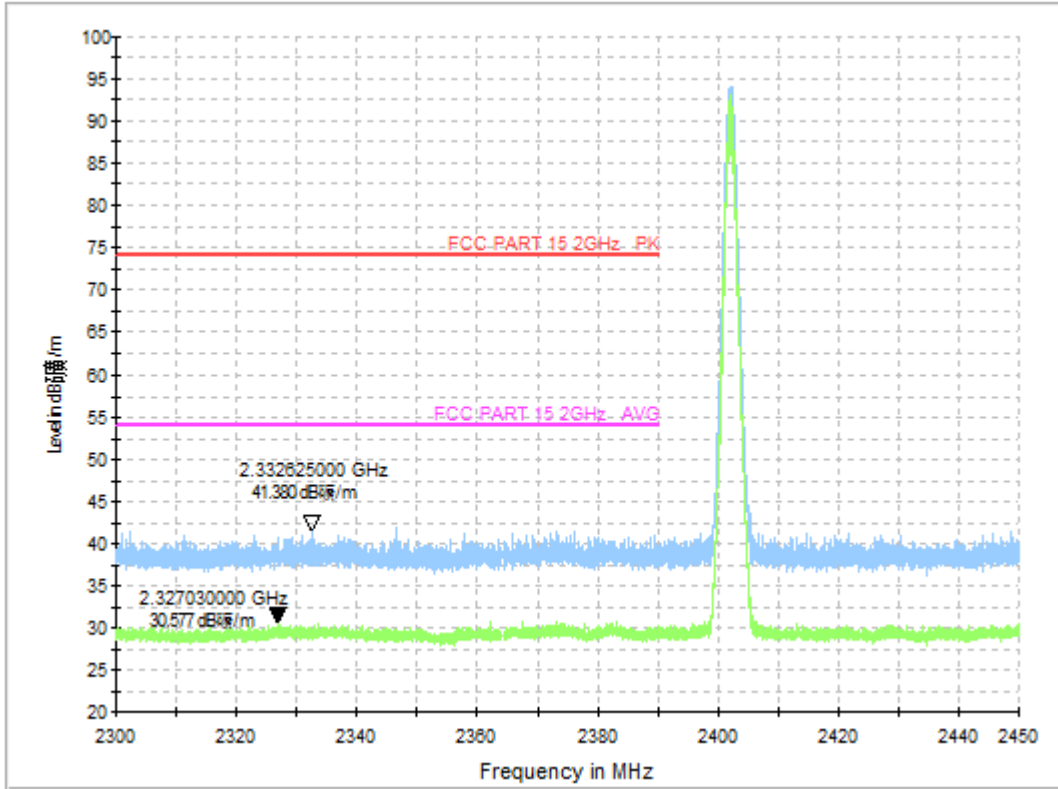

Test channel: Highest channel

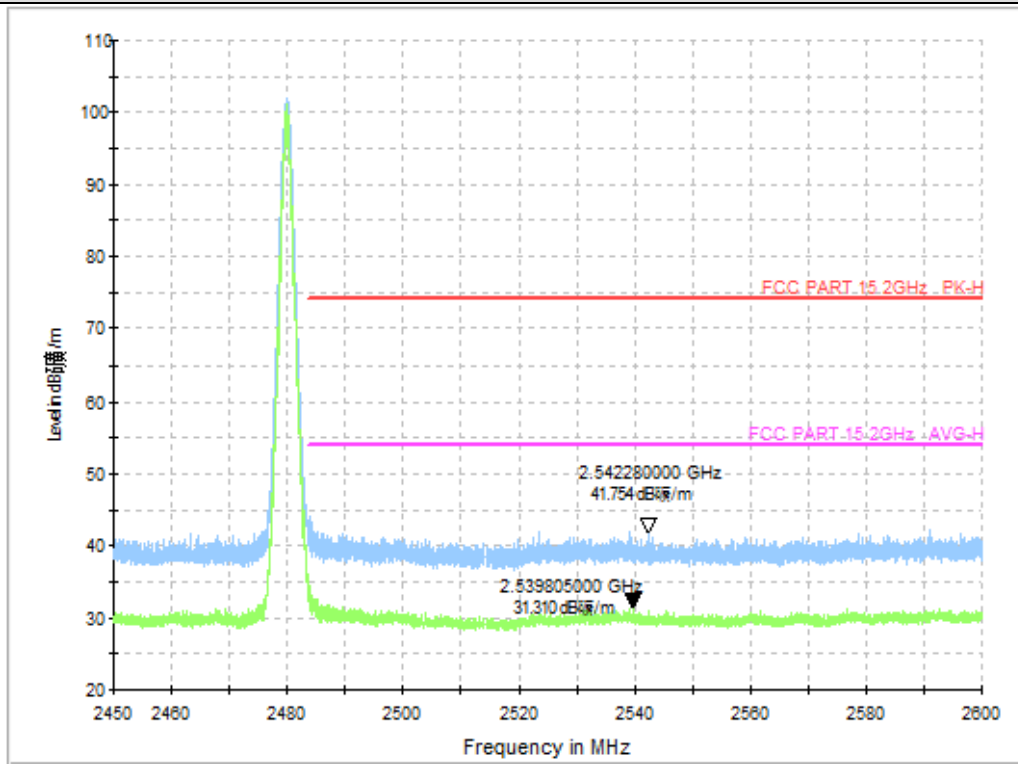

9. FREQUENCY STABILITY

9.1. Test limit

Please refer section RSS-Gen.

Regulation RSS-Gen If the frequency stability of the licence-exempt radio apparatus is not specified in the applicable RSS, the fundamental emissions of the radio apparatus should be kept within at least the central 80% of its permitted operating frequency band in order to minimize the possibility of out-of-band operation. In addition, its occupied bandwidth shall be entirely outside the restricted bands and the prohibited TV bands of 54-72 MHz, 76-88 MHz, 174-216 MHz, and 470-602 MHz, unless otherwise indicated.

9.2. Test Procedure

The following equipment are installed on the emission measurement to meet the commission requirements and operating regulations in a manner which tends to maximize its emission characteristics in normal application.

9.3. Test Setup

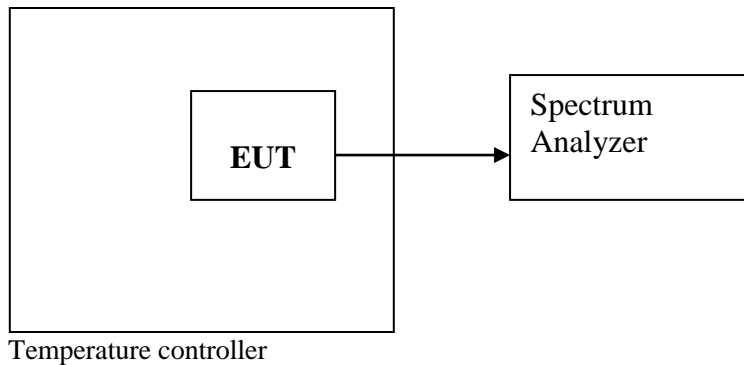

9.4. Test Results

PASS.

Detailed information please see the following page.

Assigned Frequency(MHz): 2402MHz				
Voltage	Temperature	Measured Frequency (MHz)	Frequency stability(MHz)	Limit(MHz)
Low DC 2.97V	+20°C	2401.996	-0.004	±0.020
Normal DC 3.3V	-10°C	2401.994	-0.006	±0.020
	-5°C	2401.997	-0.003	±0.020
	0°C	2401.993	-0.007	±0.020
	+10°C	2401.994	-0.006	±0.020
	+20°C	2401.992	-0.008	±0.020
	+30°C	2401.991	-0.009	±0.020
	+40°C	2402.002	0.002	±0.020
	+50°C	2401.994	-0.006	±0.020
	+60°C	2401.995	-0.005	±0.020
High DC 3.63V	+20°C	2401.997	-0.003	±0.020

10. ANTENNA REQUIREMENT

10.1. Standard Requirement

An intentional radiator shall be designed to ensure that no antenna other than that furnished by the responsible party shall be used with the device. The use of a permanently attached antenna or of an antenna that uses a unique coupling to the intentional radiator shall be considered sufficient to comply with the provisions of this Section. The manufacturer may design the unit so that a broken antenna can be replaced by the user, but the use of a standard antenna jack or electrical connector is prohibited.

10.2. Antenna Connected Construction

The antenna is Internal antenna and no consideration of replacement. Please see EUT photo for details.

10.3. Results

The EUT antenna is PCB Antenna. It comply with the standard requirement.

11. Test Setup Photo

11.1. Photos of Radiated emission

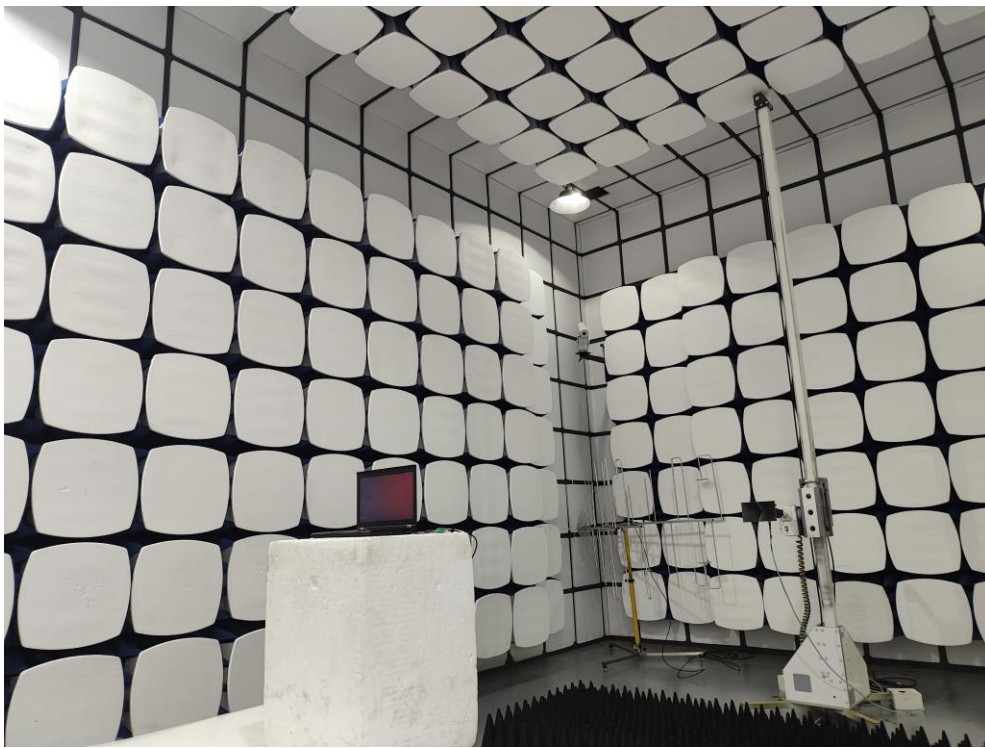

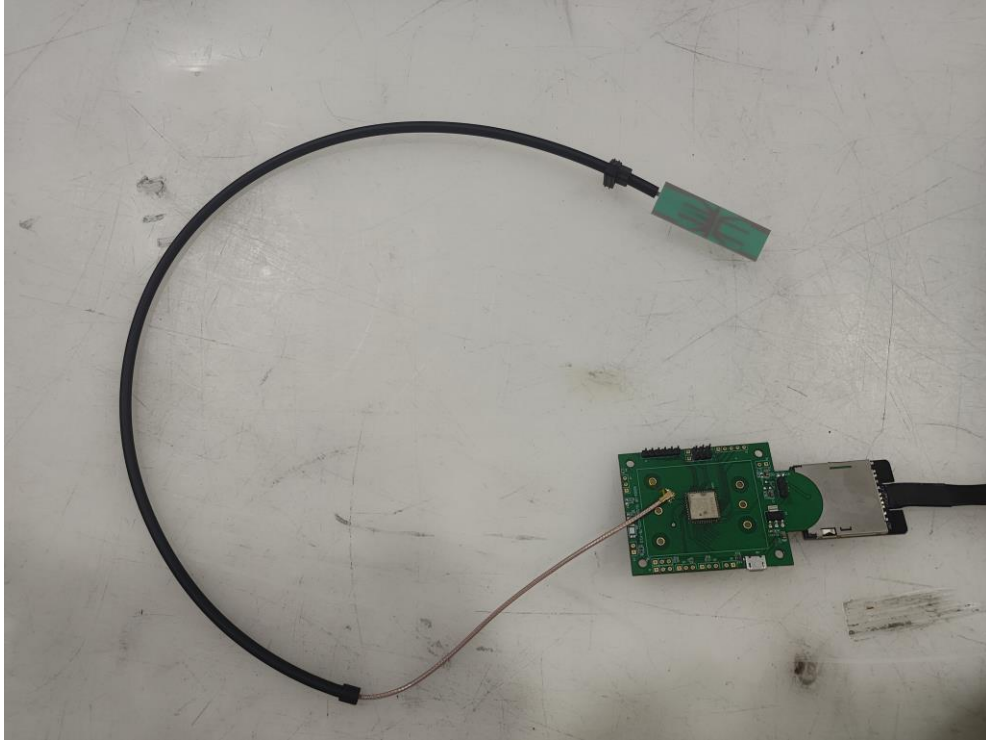

11.2.Photos of Conducted Emission test

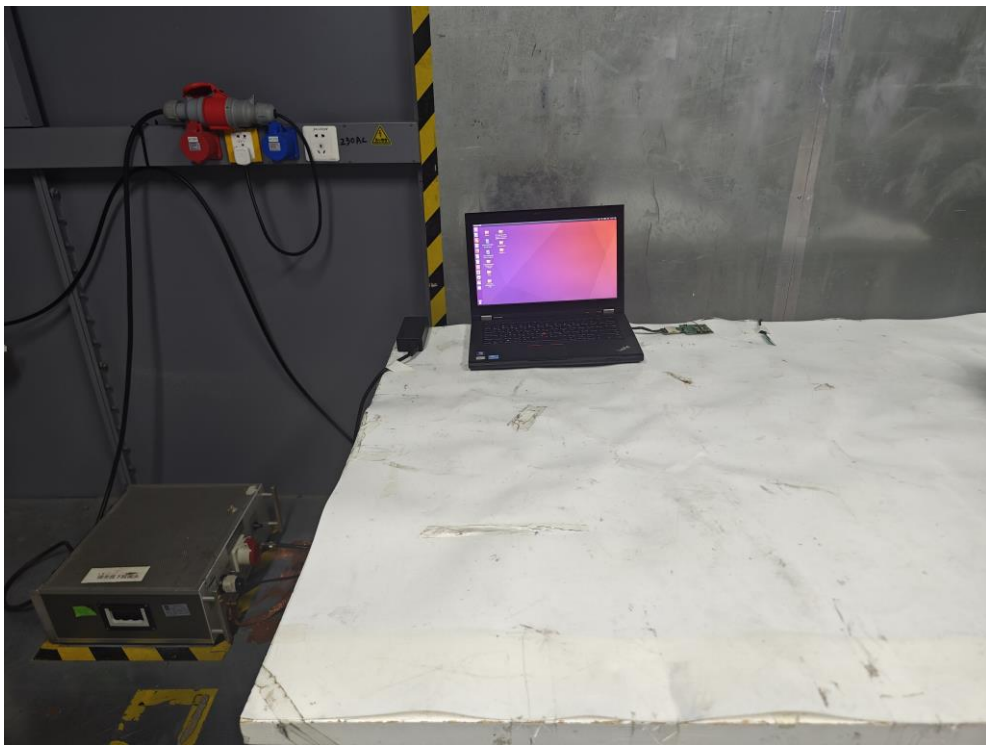



-----END OF REPORT-----