

# RADIO TEST REPORT

The device described below is tested by Dongguan Nore Testing Center Co., Ltd. to determine the maximum emission levels emanating from the device, the severe levels which the device can endure and E.U.T.'s performance criterion. The test results, data evaluation, test procedures, and equipment of configurations shown in this report were made in accordance with the procedures in ANSI C63.10(2013).

Applicant : FN-LINK TECHNOLOGY LIMITED  
Address : No.8, Litong Road, Liuyang Economic & Technical Development Zone, Changsha, Hunan China  
Manufacturer /Factory : FN-LINK TECHNOLOGY LIMITED  
Address : No.8, Litong Road, Liuyang Economic & Technical Development Zone, Changsha, Hunan China  
E.U.T. : WIFI+BT combo Module  
Brand Name : FN-LINK  
Model No. : 6223A-SRD  
FCC ID : 2AATL-6223A-SRD  
Measurement Standard : FCC PART 15.247  
Date of Receiver : November 06, 2017, October 26, 2022  
Date of Test : November 06, 2017 to November 24, 2017  
October 26, 2022 to November 14, 2022  
Date of Report : November 18 2022

This Test Report is Issued Under the Authority of :

Prepared by



Alina Guo / Engineer

Approved & Authorized Signer



Iori Fan / Authorized Signatory

This test report is for the customer shown above and their specific product only. This report applies to above tested sample only and shall not be reproduced in part without written approval of Dongguan Nore Testing Center Co., Ltd.



---

## Table of Contents

<b>1. GENERAL INFORMATION .....</b>	<b>5</b>
1.1 PRODUCT DESCRIPTION FOR EQUIPMENT UNDER TEST .....	5
1.2 RELATED SUBMITTAL(S) / GRANT (S) .....	5
1.3 TEST METHODOLOGY .....	8
1.4 EQUIPMENT MODIFICATIONS .....	8
1.5 SUPPORT DEVICE .....	8
1.6 TEST FACILITY AND LOCATION .....	9
1.7 SUMMARY OF TEST RESULTS .....	10
<b>2. SYSTEM TEST CONFIGURATION .....</b>	<b>11</b>
2.1 EUT CONFIGURATION .....	11
2.2 SPECIAL ACCESSORIES .....	11
2.3 DESCRIPTION OF TEST MODES .....	11
2.4 EUT EXERCISE .....	11
<b>3. CONDUCTED EMISSIONS TEST .....</b>	<b>12</b>
3.1 TEST SET-UP (BLOCK DIAGRAM OF CONFIGURATION) .....	12
3.2 TEST CONDITION .....	12
3.3 MEASUREMENT RESULTS .....	12
<b>4. MAX. CONDUCTED OUTPUT POWER .....</b>	<b>15</b>
4.1 MEASUREMENT PROCEDURE .....	15
4.2 TEST SET-UP (BLOCK DIAGRAM OF CONFIGURATION) .....	15
4.3 MEASUREMENT RESULTS .....	15
<b>5. 6DB&amp;20DB BANDWIDTH .....</b>	<b>17</b>
5.1 MEASUREMENT PROCEDURE .....	17
5.2 TEST SET-UP (BLOCK DIAGRAM OF CONFIGURATION) .....	17
5.3 MEASUREMENT RESULTS .....	17
<b>6. POWER SPECTRAL DENSITY .....</b>	<b>25</b>
6.1 MEASUREMENT PROCEDURE .....	25
6.2 TEST SET-UP (BLOCK DIAGRAM OF CONFIGURATION) .....	25
6.3 MEASUREMENT RESULTS .....	25
<b>7. BAND EDGE AND CONDUCTED SPURIOUS EMISSIONS .....</b>	<b>33</b>
7.1 REQUIREMENT AND MEASUREMENT PROCEDURE .....	33
7.2 TEST SET-UP (BLOCK DIAGRAM OF CONFIGURATION) .....	33
7.3 MEASUREMENT RESULTS .....	33



---

<b>8. RADIATED SPURIOUS EMISSIONS AND RESTRICTED BANDS.....</b>	<b>42</b>
8.1 TEST SET-UP (BLOCK DIAGRAM OF CONFIGURATION) .....	42
8.2 MEASUREMENT PROCEDURE .....	43
8.3 LIMIT .....	44
8.4 MEASUREMENT RESULTS .....	44
<b>9. ANTENNA APPLICATION .....</b>	<b>51</b>
9.1 ANTENNA REQUIREMENT.....	51
9.2 MEASUREMENT RESULTS .....	51
<b>10. TEST EQUIPMENT LIST.....</b>	<b>52</b>



### Revision History of This Test Report

Report Number	Description	Issued Date
NTC1706431FV00	Initial Issue	2017-11-25
NTC1706431FV01	Add an optional antenna and change address of Applicant, Manufacturer, Factory	2022-11-18

---

## 1. GENERAL INFORMATION

### 1.1 Product Description for Equipment under Test

Product Name	:	WIFI+BT combo Module
Model Name	:	6223A-SRD
Model difference	:	None
Brand Name	:	FN-LINK
Power Supply	:	DC 3.3V
Adapter	:	None
Test voltage	:	AC 120V 60Hz(PC input)
Hardware version	:	V1.0
Software version	:	V1.0
Serial number	:	N/A
Note	:	This report only applies to modulation technology DTS(WIFI).
Remark	:	1. This report was an additional report based on original report NTC1706431EV00. 2. Compared with the original report, this report has added an optional antenna and change address of Applicant, Manufacturer, Factory, antenna information detail see page 6. 3. According to the change, We retested the Radiated Spurious Emissions item, the other test result will not be affected, thus, the original test data were continued to be referenced, details refer to the report.

**Technical parameters**

- Frequency Range : 2412-2462MHz for 802.11b/g/n(HT20)  
2422-2452MHz for 802.11n(HT40)
- Modulation : DSSS for 802.11b  
OFDM for 802.11g/n(HT20)/n(HT40)
- Number of Channel : 11 for 802.11b/g/n(HT20)  
7 for 802.11n(HT40)
- Channel space : 5MHz
- Date Rate : 802.11b:1~11Mbps,  
802.11g:6~54Mbps  
802.11n: 6.5~135Mbps
- Antenna Type : Please refer to below antenna information.
- Antenna Gain : Please refer to below antenna information.

**Antenna Information**

Ant.	Brand	Model name	Antenna Type	Connector	Gain (dBi)
1	ZHONGTIAN XUN	2.00001213	PIFA	I-PEX	2.99
2	XK	XKFPC-2D4-5D8-150	PIFA	I-PEX	0.0
3	XK	XK-QX2400-PCB-140	PIFA	I-PEX	2.0
4	ZHONGTIAN XUN	2.00001050	PIFA	I-PEX	0.38
5	Abracon	PRO-OB-440	Stamped Metal Antenna	I-PEX	4.9

Note: The EUT has two types of antenna, all tests were based on the maximum Gain of PIFA type antenna. And the for Stamped Metal Antenna we have tests items Radiated Spurious Emissions.

**WIFI Channel List**

802.11 b/g/n(HT20)		802.11 n(HT40)	
Channel	Frequency MHz	Channel	Frequency MHz
1	2412	---	---
2	2417	---	---
3	2422	3	2422
4	2427	4	2427
5	2432	5	2432
6	2437	6	2437
7	2442	7	2442
8	2447	8	2447
9	2452	9	2452
10	2457	---	---
11	2462	---	---

**Note:** According to section 15.31(m), regards to the operating frequency range over 10MHz, the Lowest, middle, and the Highest frequency of channel were selected to perform the test. The selected frequency see below:

802.11b/g/n(HT20)		802.11 n(HT40)	
Channel	Frequency MHz	Channel	Frequency MHz
1	2412	3	2422
6	2437	6	2437
11	2462	9	2452

<b>Test SW version</b>	<b>REALTEK 11N 8723DU SDIO WLAN MP Diagnostic Program</b>
------------------------	---



## 1.2 Related Submittal(s) / Grant (s)

This submittal(s) (test report) is intended for FCC ID: **2AATL-6223A-SRD** filing to comply with Section 15.247 of the FCC Part 15(2016), Subpart C Rule.

## 1.3 Test Methodology

Both AC mains line-conducted and radiated emission measurements were performed according to the procedures in ANSI C63.10 (2013). Radiated emission measurement was performed in semi-anechoic chamber and conducted emission measurement was performed in shield room. For radiated emission measurement, preliminary scans were performed in the semi-anechoic chamber only to determine the worst case modes. All radiated tests were performed at an antenna to EUT distance of 3 meters.

## 1.4 Equipment Modifications

Not available for this EUT intended for grant.

## 1.5 Support Device

PC	:	M/N: G7060cx S/N: 4CV110D8FK Power Cord: 1.8m Unshielded, with core CE, FCC: DOC
Monitor	:	Manufacturer: LENOVO M/N: L2061WD S/N: 3M04769B1102083 CE, FCC: DOC
Mouse	:	Manufacturer: Logitech M/N: M-U0026 P/N: 810-002182 CE, FCC: DOC
Keyboard	:	Manufacturer: Logitech M/N: Y-U0009 S/N: 1345MG025YK8 CE, FCC: DOC





## 1.6 Test Facility and Location

### Site Description

EMC Lab : Listed by CNAS, August 14, 2015  
The certificate is valid until August 13, 2018  
The Laboratory has been assessed and proved to be in compliance with CNAS/CL01  
The Certificate Registration Number is L5795.

Listed by A2LA, November 01, 2017  
The certificate is valid until December 31, 2019  
The Laboratory has been assessed and proved to be in compliance with ISO17025  
The Certificate Registration Number is 4429.01

Listed by FCC, November 06, 2017  
The Designation Number is CN1214  
Test Firm Registration Number: 907417

Listed by Industry Canada, June 08, 2017  
The Certificate Registration Number. Is 46405-9743  
Name of Firm : Dongguan Nore Testing Center Co., Ltd.  
(Dongguan NTC Co., Ltd.)

Site Location : Building D, Gaosheng Science & Technology Park,  
Zhouxi Longxi Road, Nancheng District, Dongguan  
City, Guangdong Province, China



### 1.7 Summary of Test Results

FCC Rules	Description Of Test	Uncertainty	Result
§15.207 (a)	AC Power Conducted Emission	±1.06dB	Compliant
§15.247(b)(3)	Max. Conducted Output Power	±1.06dB	Compliant
§15.247(a)(2)	6dB Bandwidth	±1.42 x10 <sup>-4</sup> %	Compliant
§15.247(e)	Power Spectral Density	±1.06dB	Compliance
§15.247(d)	Band Edge and Conducted Spurious Emissions	±1.70dB & ±2.51dB	Compliance
§15.247(d),§15.209, §15.205	Radiated Spurious Emissions and Restricted Bands	±3.70dB	Compliance
§15.203	Antenna Requirement	---	Compliance

---

## 2. System Test Configuration

### 2.1 EUT Configuration

The EUT configuration for testing is installed on RF field strength measurement to meet the Commissions requirement and operating in a manner which intends to maximize its emission characteristics in a continuous normal application.

### 2.2 Special Accessories

Not available for this EUT intended for grant.

### 2.3 Description of test modes

The EUT has been tested under continuous operating condition. Test program used to control the EUT staying in continuous transmitting mode. The Lowest, middle and highest channel were chosen for testing, and modulation type CCK, DQPSK, DBPSK, OFDM and all data rate were tested. But only the worst case data is shown in this report.

### 2.4 EUT Exercise

The EUT was operated in the engineering mode to fix the Tx frequency that was for the purpose of the measurements.

### 3. Conducted Emissions Test

#### 3.1 Test SET-UP (Block Diagram of Configuration)

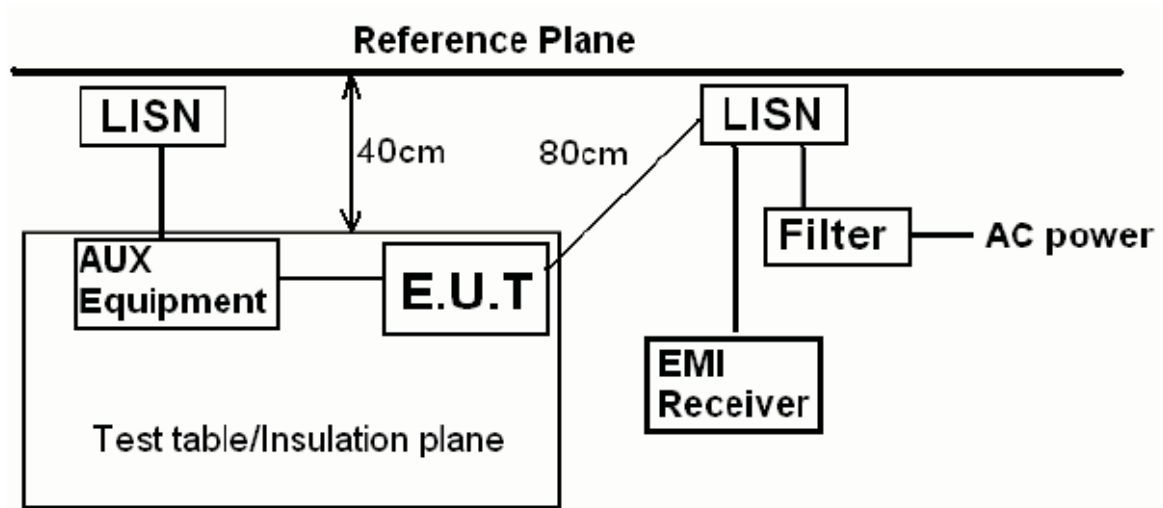

#### 3.2 Test Condition

Test Requirement: FCC Part 15.207

Frequency Range: 150 KHz ~ 30 MHz

Detector: RBW 9 KHz, VBW 30 KHz

Operation Mode: WIFI Mode

#### 3.3 Measurement Results

Please refer to following plots of the worst case (802.11g Mid Channel).

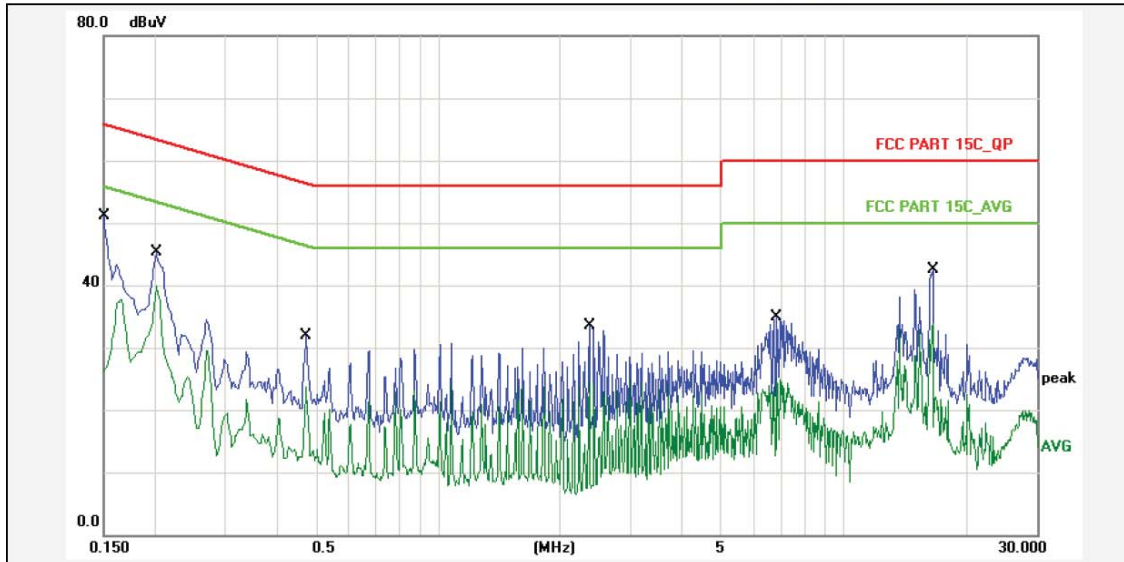

Report No.: 6223A-SRD  
 Test Standard: FCC PART 15C\_QP  
 Test item: Conducted Emission  
 Applicant: FN-LINK  
 Product: WIFI+BT combo Module  
 Model No.: 6223A-SRD  
 Phase: N  
 Temp.( )/Hum.(%): 26(C) / 52 %  
 Power Rating: AC 120V/60Hz  
 Test Engineer: Lay  
 Test Mode: TX(Wi-Fi)  
 Remark: 802.11g Mid Channel

No.	Frequency (MHz)	Factor (dBuV)	Reading (dBuV)	Level (dBuV)	Limit (dBuV)	Margin (dB)	Detector	P/F	Remark
1	0.1500	10.80	38.30	49.10	65.99	-16.89	QP	P	
2	0.1500	10.80	19.00	29.80	55.99	-26.19	AVG	P	
3	0.2020	10.80	32.50	43.30	63.52	-20.22	QP	P	
4	0.2020	10.80	27.20	38.00	53.52	-15.52	AVG	P	
5	0.4740	10.80	19.10	29.90	56.44	-26.54	QP	P	
6	0.4740	10.80	10.90	21.70	46.44	-24.74	AVG	P	
7	2.3660	10.80	20.80	31.60	56.00	-24.40	QP	P	
8	2.3660	10.80	11.80	22.60	46.00	-23.40	AVG	P	
9	6.8259	10.80	22.10	32.90	60.00	-27.10	QP	P	
10	6.8259	10.80	12.20	23.00	50.00	-27.00	AVG	P	
11	16.5739	10.80	29.70	40.50	60.00	-19.50	QP	P	
12	16.5739	10.80	21.10	31.90	50.00	-18.10	AVG	P	

Note: Level=Reading+Factor.

Margin=Limit-Level.

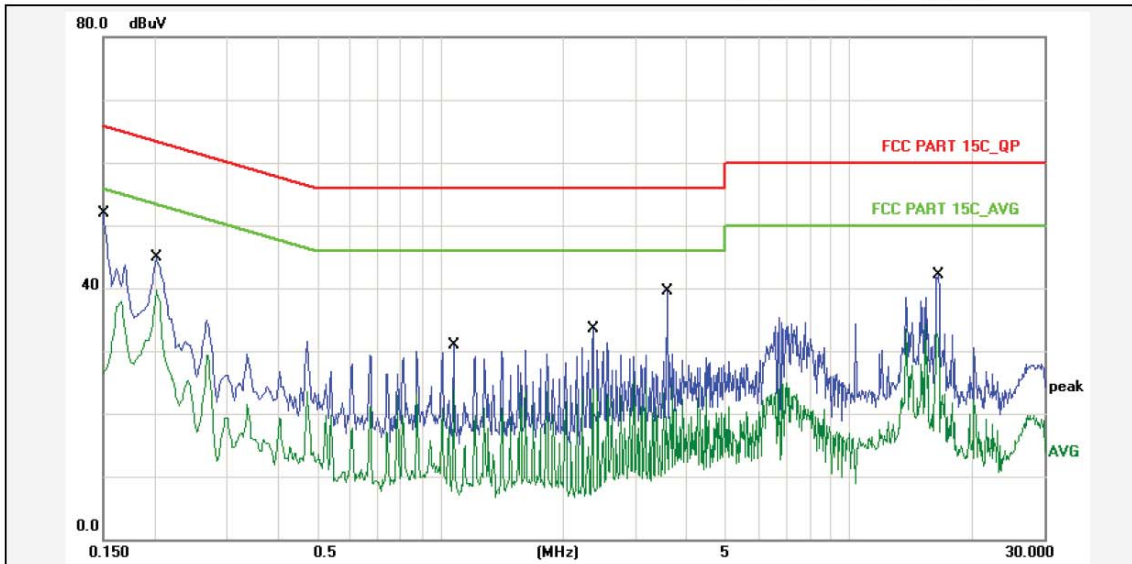

Report No.: 6223A-SRD  
 Test Standard: FCC PART 15C\_QP  
 Test item: Conducted Emission Phase: L1  
 Applicant: FN-LINK Temp.( )/Hum.(%): 26(C) / 52 %  
 Product: WIFI+BT combo Module Power Rating: AC 120V/60Hz  
 Model No.: 6223A-SRD Test Engineer: Lay

Test Mode: TX(Wi-Fi)  
 Remark: 802.11g Mid Channel

No.	Frequency (MHz)	Factor (dBuV)	Reading (dBuV)	Level (dBuV)	Limit (dBuV)	Margin (dB)	Detector	P/F	Remark
1	0.1500	10.80	39.20	50.00	65.99	-15.99	QP	P	
2	0.1500	10.80	18.90	29.70	55.99	-26.29	AVG	P	
3	0.2020	10.80	32.10	42.90	63.52	-20.62	QP	P	
4	0.2020	10.80	26.80	37.60	53.52	-15.92	AVG	P	
5	1.0820	10.80	18.10	28.90	56.00	-27.10	QP	P	
6	1.0820	10.80	11.10	21.90	46.00	-24.10	AVG	P	
7	2.3660	10.80	20.60	31.40	56.00	-24.60	QP	P	
8	2.3660	10.80	11.40	22.20	46.00	-23.80	AVG	P	
9	3.5860	10.80	26.70	37.50	56.00	-18.50	QP	P	
10	3.5860	10.80	11.60	22.40	46.00	-23.60	AVG	P	
11	16.5619	10.80	29.30	40.10	60.00	-19.90	QP	P	
12	16.5619	10.80	21.50	32.30	50.00	-17.70	AVG	P	

Note: Level=Reading+Factor.

Margin=Limit-Level.

---

## 4. Max. Conducted Output Power

### 4.1 Measurement Procedure

Maximum Conducted Output power at Antenna Terminals, FCC Rules 15.247(b)(3):

One of the following procedures may be used to determine the maximum peak conducted output power of a DTS EUT.

The maximum peak conducted output power may be measured using a broadband peak RF power meter. The power meter shall have a video bandwidth that is greater than or equal to the DTS bandwidth and shall utilize a fast-responding diode detector.

### 4.2 Test SET-UP (Block Diagram of Configuration)



### 4.3 Measurement Results

**Pass**

Please refer to following table and plots.



Temperature :	24 °C	Humidity :	50%
Test By:	Sance	Test Date :	November 21, 2017
Test Result:	PASS		
Frequency MHz	Data Rate Mbps	Peak Output Power dBm	Limit dBm
IEEE 802.11b Mode (CCK)			
Low Channel: 2412	1	11.42	30
Middle Channel: 2437	1	11.89	30
High Channel: 2462	1	12.02	30
IEEE 802.11g Mode (OFDM)			
Low Channel: 2412	6	11.88	30
Middle Channel: 2437	6	12.32	30
High Channel: 2462	6	12.27	30
IEEE 802.11n(HT20) Mode (OFDM)			
Low Channel: 2412	6.5	11.66	30
Middle Channel: 2437	6.5	12.11	30
High Channel: 2462	6.5	12.21	30
IEEE 802.11n(HT40) Mode (OFDM)			
Low Channel: 2422	13	10.00	30
Middle Channel: 2437	13	10.10	30
High Channel: 2452	13	10.49	30



---

## 5. 6dB Bandwidth

### 5.1 Measurement Procedure

DTS 6dB Channel Bandwidth, FCC Rule 15.247(a)(2):

The antenna port of the EUT was connected to the input of a spectrum analyzer. Analyzer was set as below according to FCC KDB558074(v03r03):

1. For 6dB bandwidth, Set the RBW = 100KHz.
2. Set the VBW  $\geq 3 \times$  RBW
3. Detector = peak.
4. Sweep time = auto couple.
5. Trace mode = max hold.
6. Allow trace to fully stabilize.
7. Measure the maximum width of the emission that is constrained by the frequencies associated with the two outermost amplitude points (upper and lower frequencies) that are attenuated by 6 dB relative to the maximum level measured in the fundamental emission.

### 5.2 Test SET-UP (Block Diagram of Configuration)



### 5.3 Measurement Results

**Pass**

Please refer to following table and plots.

Temperature :	24 °C	Humidity : 50 %	
Test By:	Sance	Test Date : November 21, 2017	
Test Result:	PASS		
Frequency MHz	Data Rate Mbps	6dB Bandwidth MHz	Limit
IEEE 802.11b Mode (CCK)			
Low Channel: 2412	1	10.13	>500KHz
Middle Channel: 2437	1	10.13	>500KHz
High Channel: 2462	1	10.13	>500KHz
IEEE 802.11g Mode (OFDM)			
Low Channel: 2412	6	16.41	>500KHz
Middle Channel: 2437	6	16.41	>500KHz
High Channel: 2462	6	16.41	>500KHz
IEEE 802.11n(HT20) Mode (OFDM)			
Low Channel: 2412	6.5	17.69	>500KHz
Middle Channel: 2437	6.5	17.69	>500KHz
High Channel: 2462	6.5	17.69	>500KHz
IEEE 802.11n(HT40) Mode (OFDM)			
Low Channel: 2422	13	36.03	>500KHz
Middle Channel: 2437	13	36.03	>500KHz
High Channel: 2452	13	36.03	>500KHz

### 802.11b Low Channel

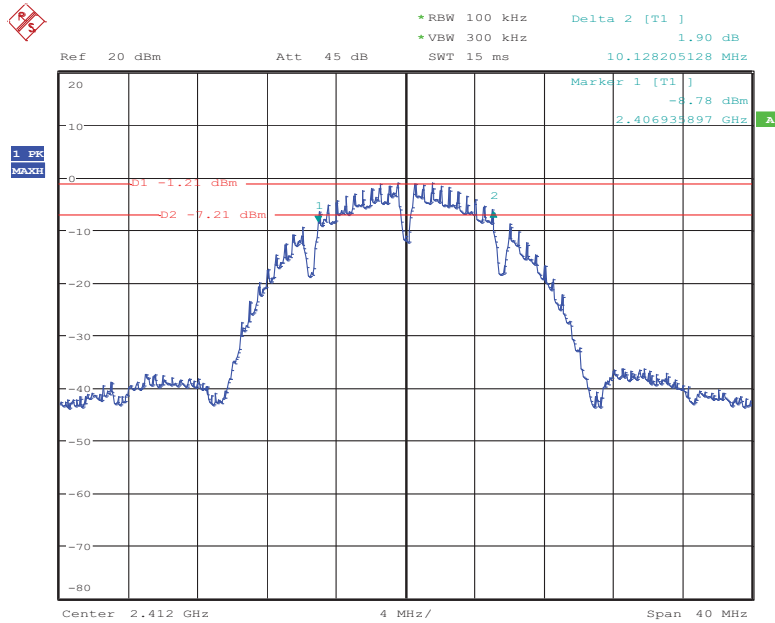

### 802.11b Middle Channel

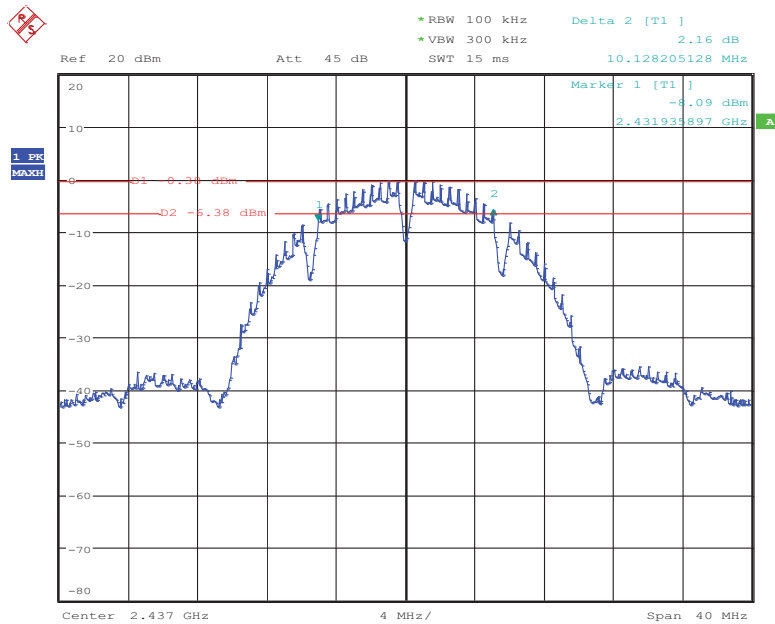

### 802.11b High Channel

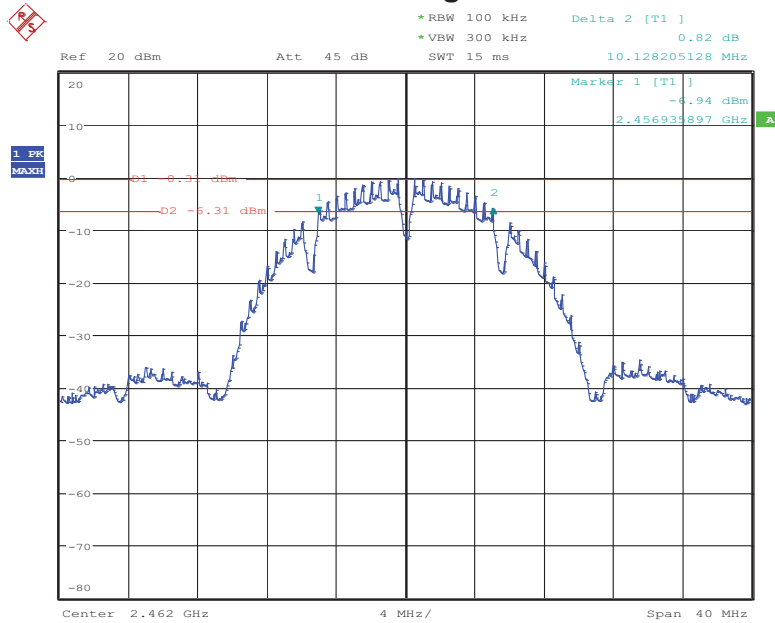

### 802.11g Low Channel

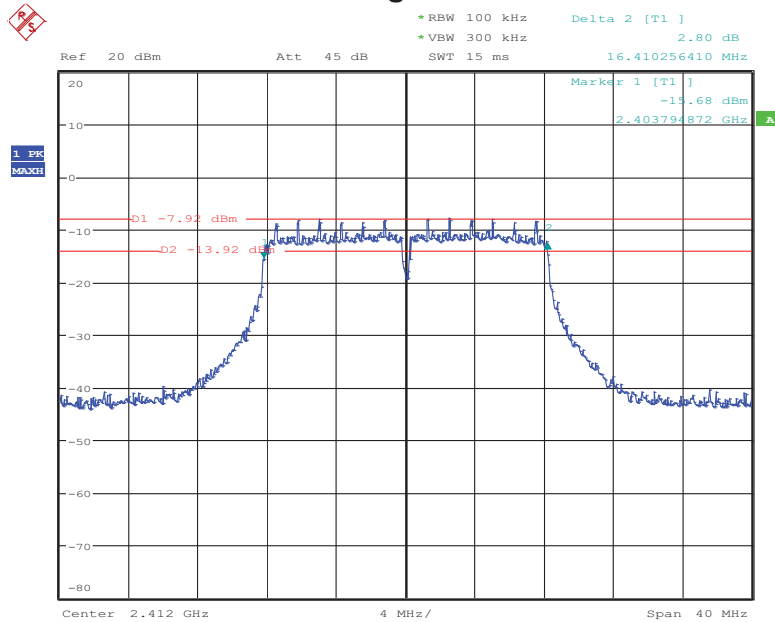

### 802.11g Middle Channel

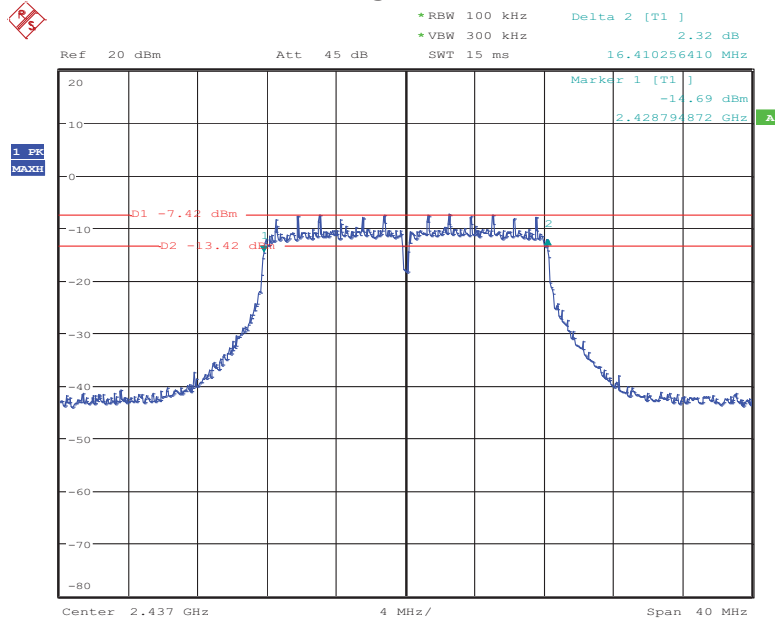

### 802.11g High Channel

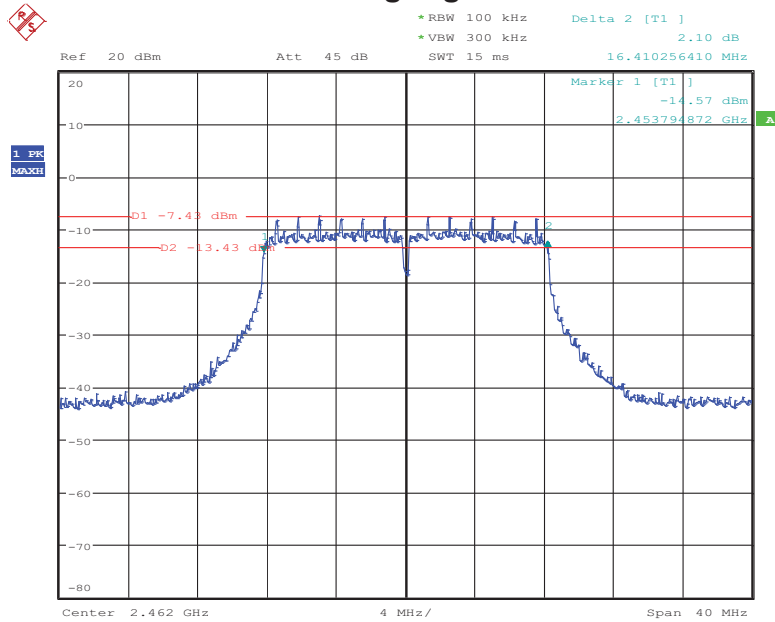

### 802.11n(HT20) Low Channel

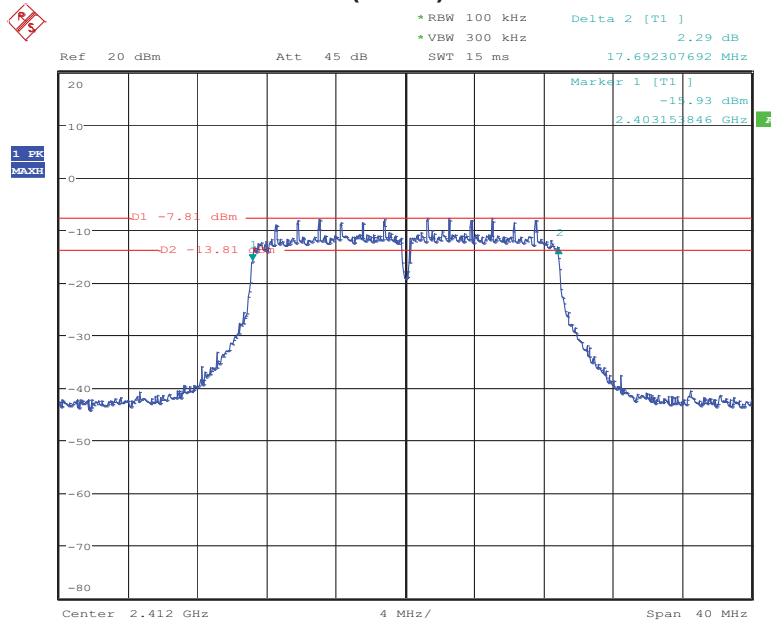

### 802.11n(HT20) Middle Channel

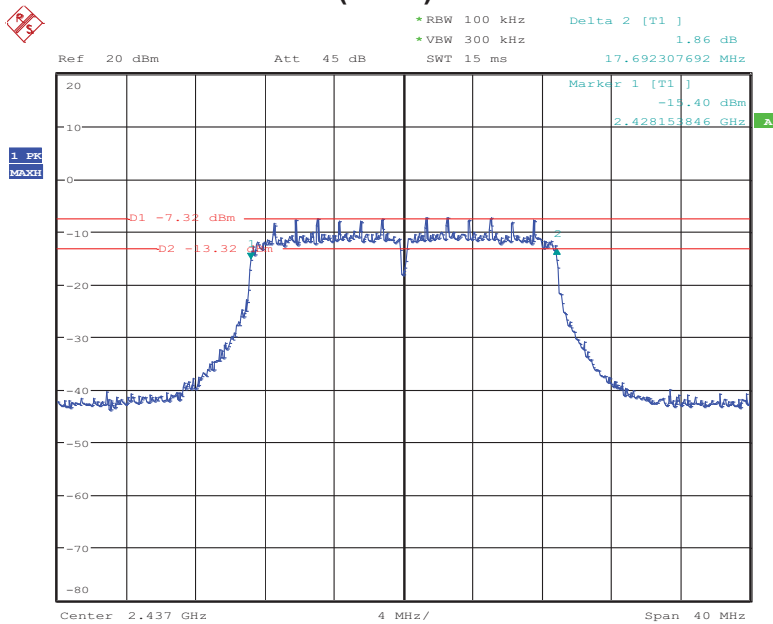

### 802.11n(HT20) High Channel

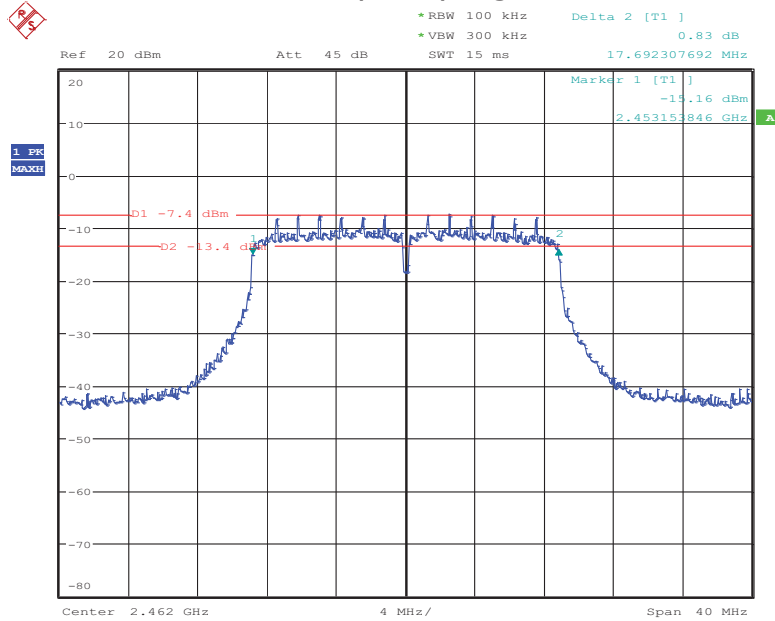

### 802.11n(HT40) Low Channel

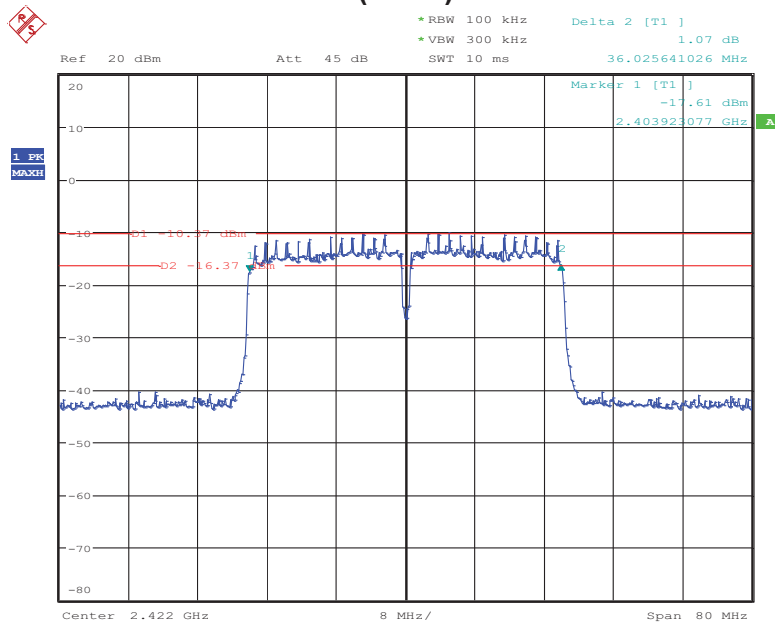

### 802.11n(HT40) Middle Channel

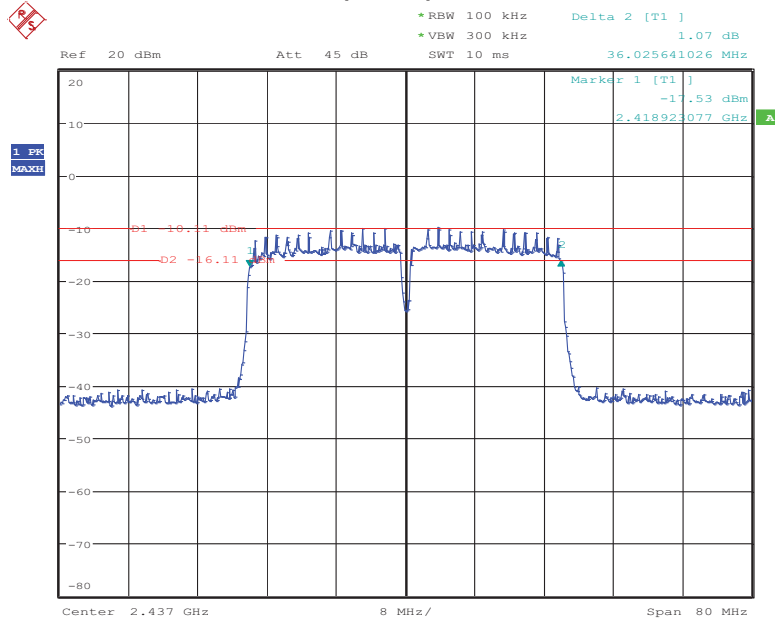

### 802.11n(HT40) High Channel

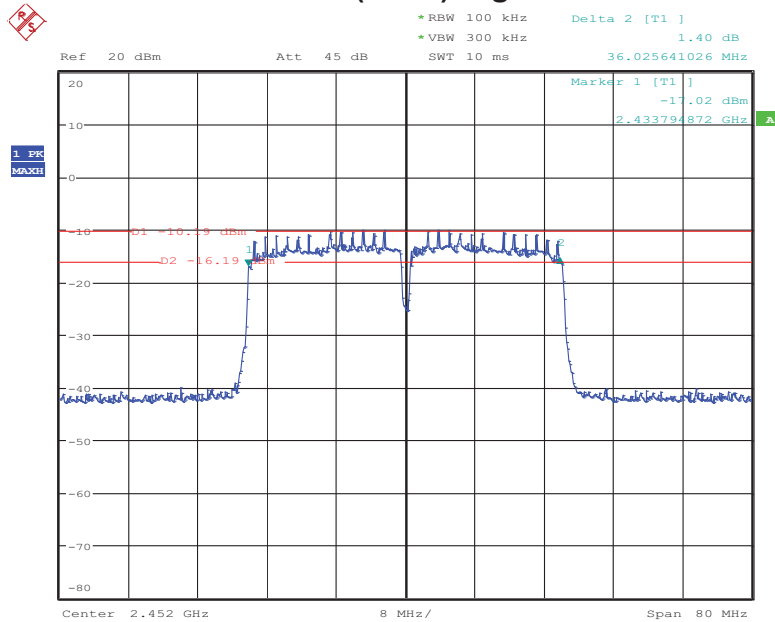



## 6. Power Spectral Density

### 6.1 Measurement Procedure

DTS 6dB Channel Bandwidth, FCC Rule 15.247(a)(2):

The antenna port of the EUT was connected to the input of a spectrum analyzer. Analyzer was set as below according to FCC KDB558074 (v03r03):

1. Set analyzer center frequency to DTS channel center frequency.
2. Set the span to 1.5 times the DTS bandwidth.
3. Set the RBW to:  $3\text{ kHz} \leq \text{RBW} \leq 100\text{ kHz}$
4. Set the VBW  $\geq 3 \times \text{RBW}$ .
5. Detector = peak.
6. Sweep time = auto couple.
7. Trace mode = max hold.
8. Allow trace to fully stabilize.
9. Use the peak marker function to determine the maximum amplitude level within the RBW.
10. If measured value exceeds limit, reduce RBW (no less than 3 kHz) and repeat.

### 6.2 Test SET-UP (Block Diagram of Configuration)



### 6.3 Measurement Results

**Pass**

Please refer to following table and plots.



Temperature :	24 °C	Humidity :	50 %
Test By:	Sance	Test Date :	November 22, 2017
Test Result:	PASS		
Frequency MHz	Data Rate Mbps	PSD dBm/3kHz	Limit dBm/3kHz
IEEE 802.11b Mode (CCK)			
Low Channel: 2412	1	-14.54	8
Middle Channel: 2437	1	-14.54	8
High Channel: 2462	1	-13.29	8
IEEE 802.11g Mode (OFDM)			
Low Channel: 2412	6	-21.78	8
Middle Channel: 2437	6	-20.48	8
High Channel: 2462	6	-21.39	8
IEEE 802.11n(HT20) Mode (OFDM)			
Low Channel: 2412	6.5	-20.54	8
Middle Channel: 2437	6.5	-21.80	8
High Channel: 2462	6.5	-20.31	8
IEEE 802.11n(HT40) Mode (OFDM)			
Low Channel: 2422	13	-24.89	8
Middle Channel: 2437	13	-24.40	8
High Channel: 2452	13	-23.07	8

### 802.11b Low Channel

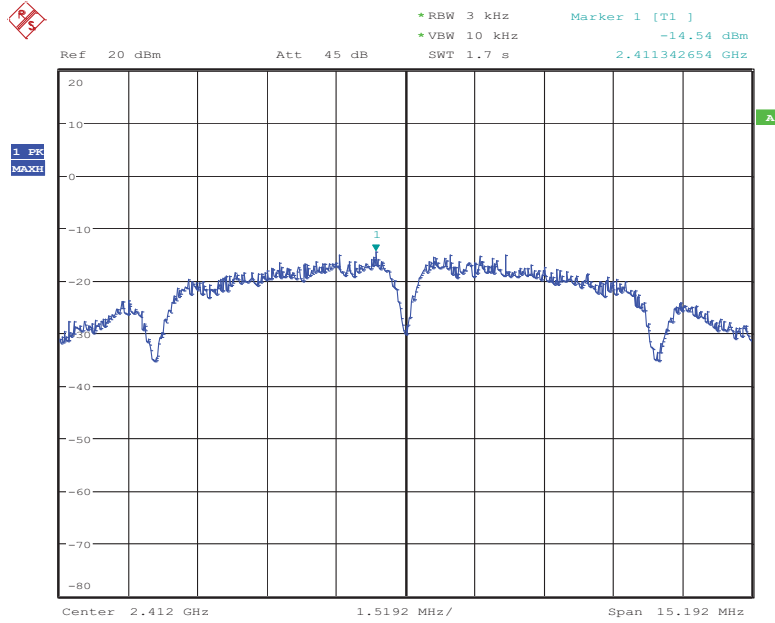

### 802.11b Middle Channel

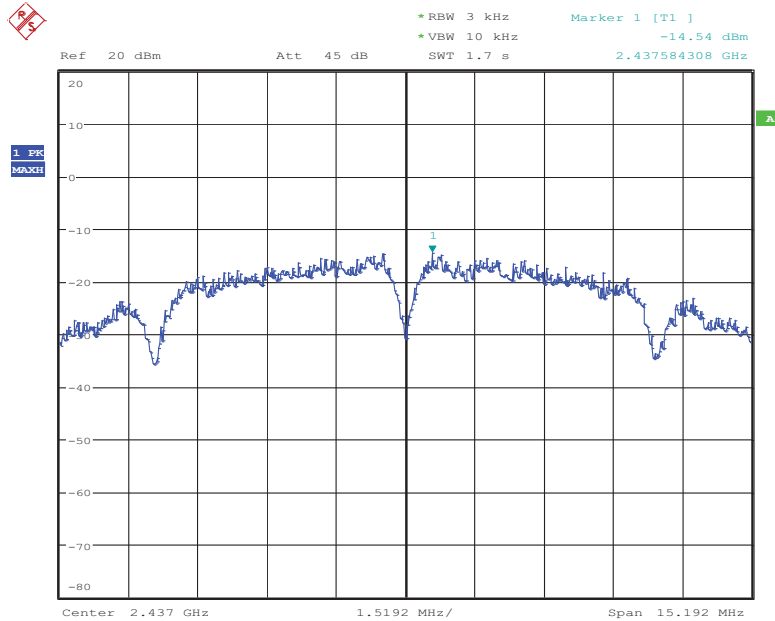

### 802.11b High Channel

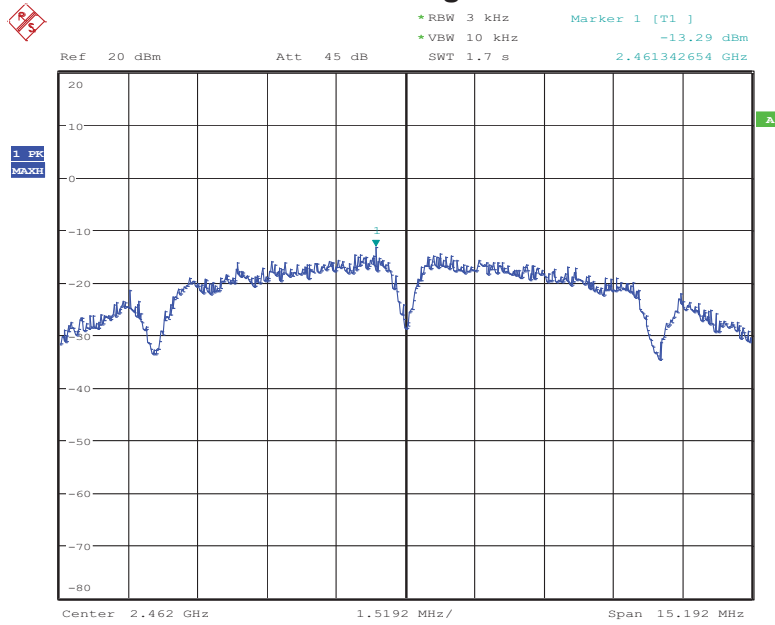

### 802.11g Low Channel

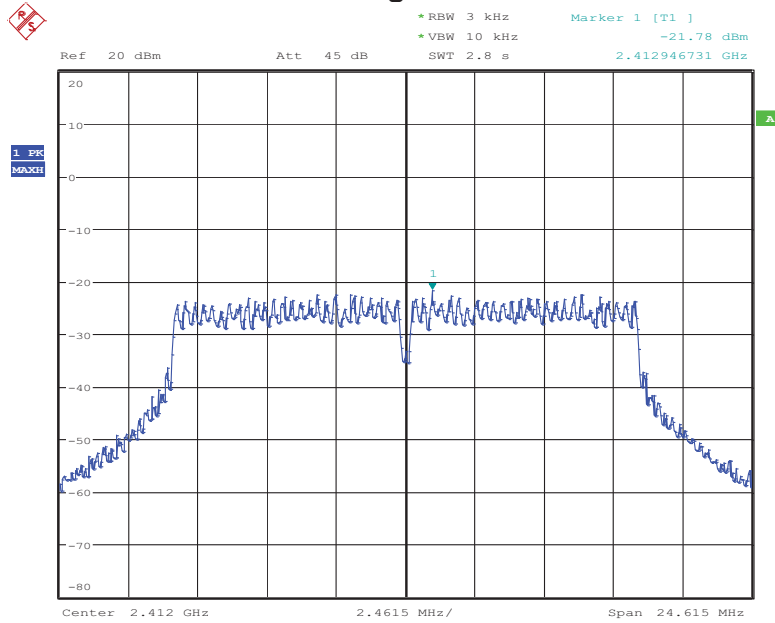

### 802.11g Middle Channel

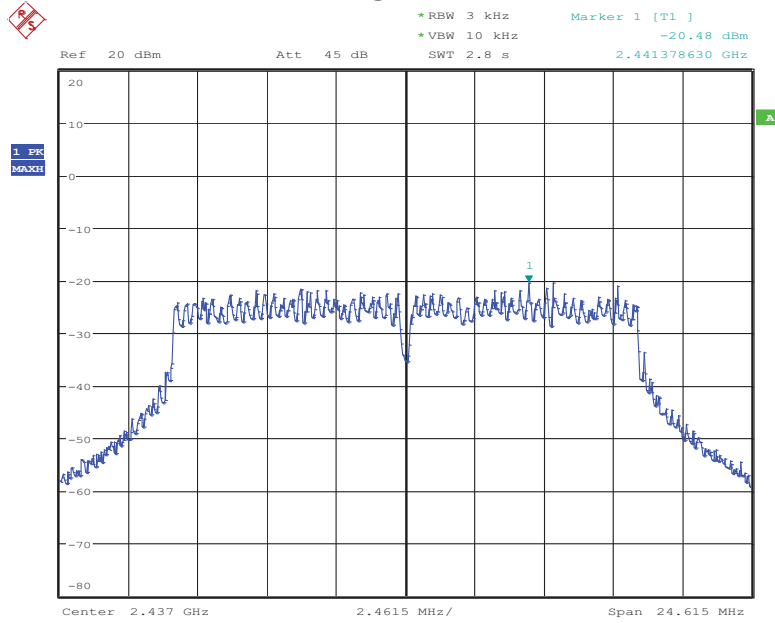

### 802.11g High Channel

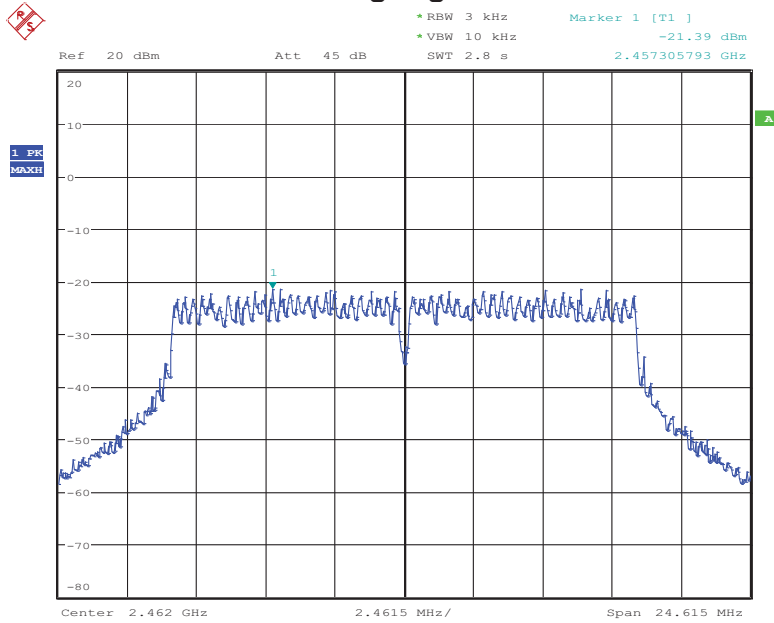

### 802.11n(HT20) Low Channel

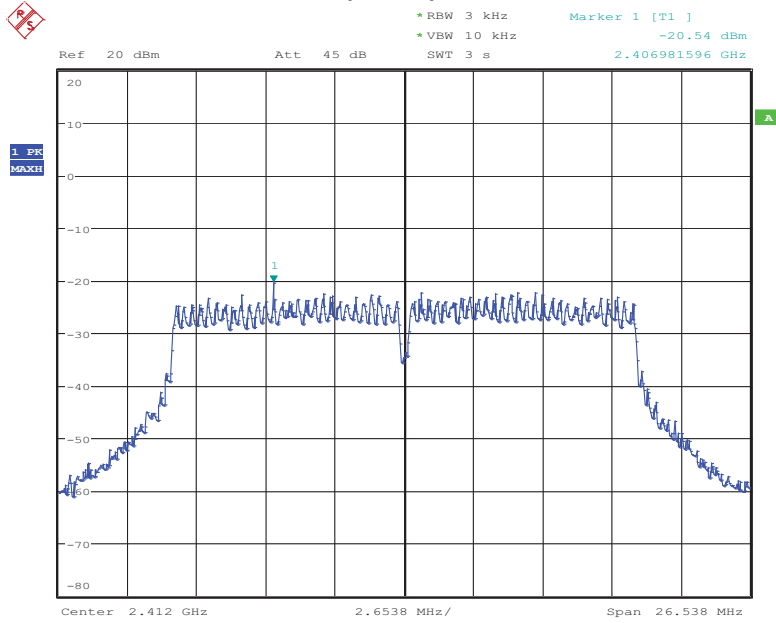

### 802.11n(HT20) Middle Channel

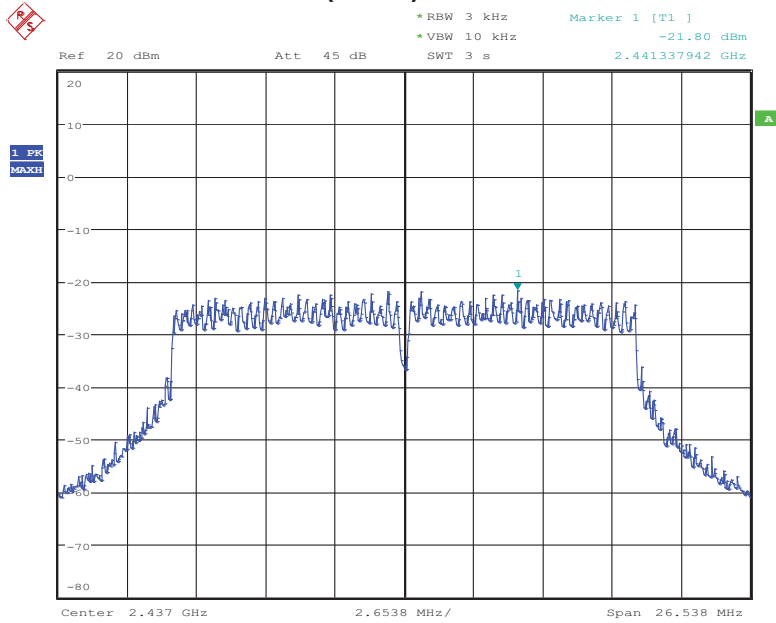

### 802.11n(HT20) High Channel

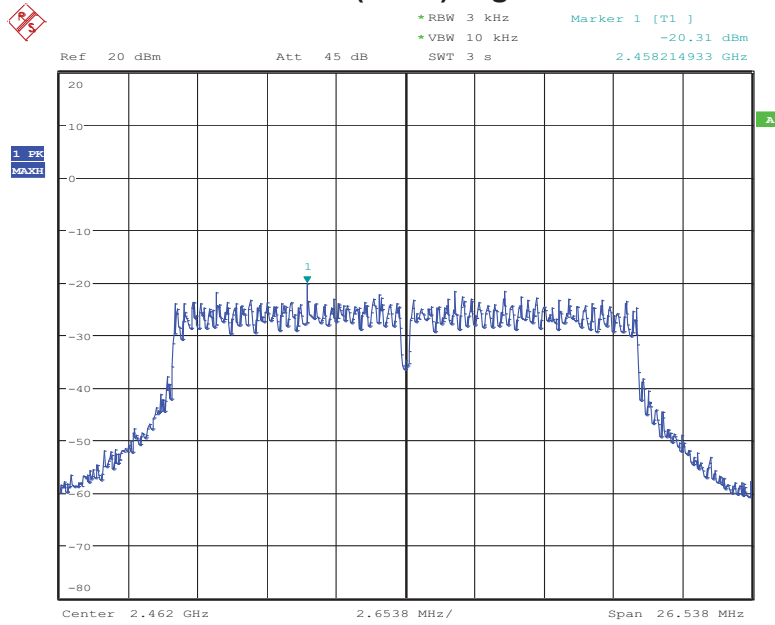

### 802.11n(HT40) Low Channel

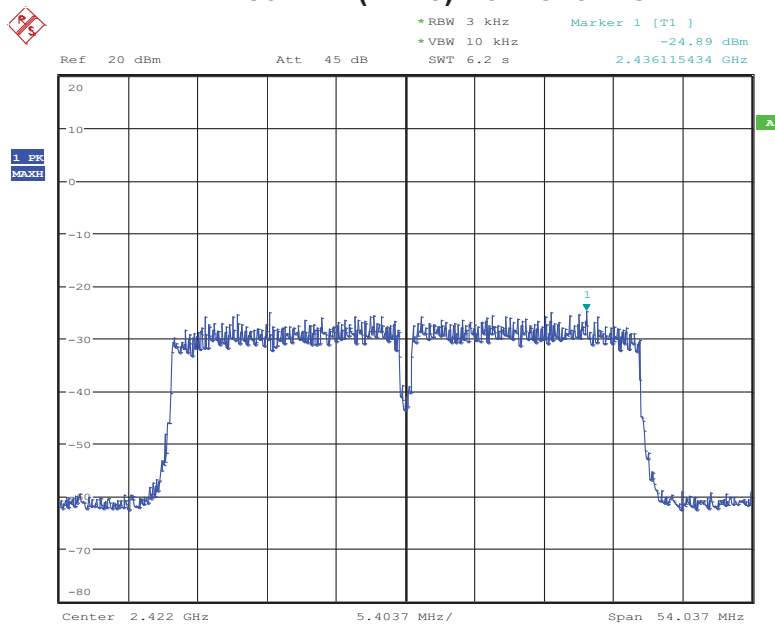

### 802.11n(HT40) Middle Channel

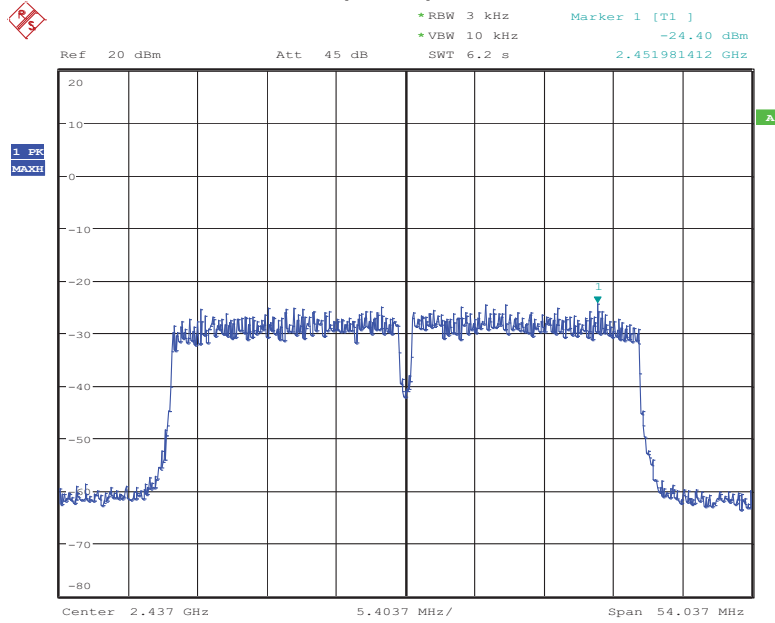

### 802.11n(HT40) High Channel

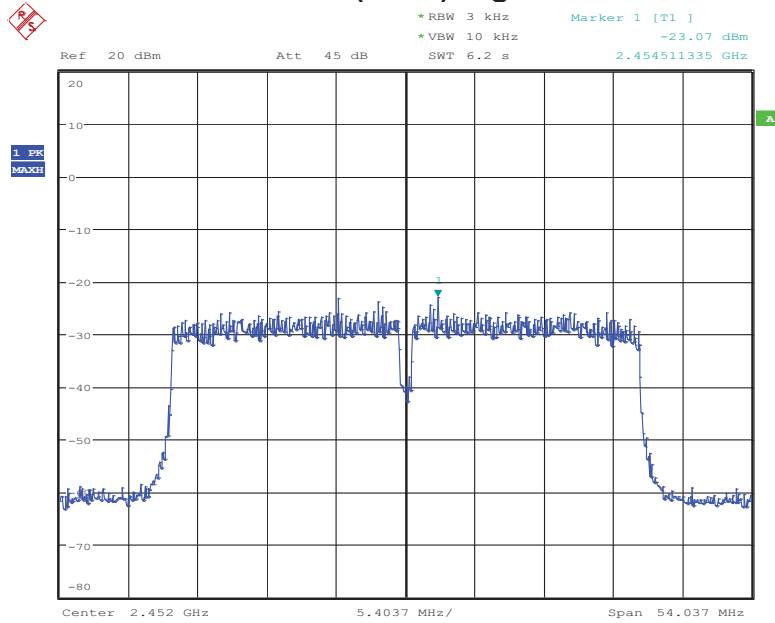



## 7. Band Edge and Conducted Spurious Emissions

### 7.1 Requirement and Measurement Procedure

In any 100KHz bandwidth outside the frequency band in which the spread spectrum intentional radiator is operating, the radio frequency power that is produced by the intentional radiator shall be at least 20dB below that in the 100KHz bandwidth within the band that contains the highest level of the desired power, based on either an RF conducted or a radiated measurement.

The antenna port of the EUT was connected to the input of a spectrum analyzer. Analyzer was set as below.

A Quasi-peak measurement was then made for that frequency point for below 1GHz test. PK and AV for above 1GHz emission test.

During the radiated emission test, the spectrum analyzer was set with the following configurations:

Frequency Band (MHz)	Level	Resolution Bandwidth	Video Bandwidth
30 to 1000	QP	120 kHz	300 kHz
Above 1000	Peak	1 MHz	3 MHz
	Average	1 MHz	10 Hz

### 7.2 Test SET-UP (Block Diagram of Configuration)



### 7.3 Measurement Results

The test plots and table showed all spurious emission and up to the tenth harmonic was measured and they were found to be at least 20dB below the highest level of the desired power in the passband. Please refer to below plots.



**Original antenna test results:**

Spurious Emission in restricted band:

Operation Mode: TX                      Test Date : November 21, 2017  
 Frequency Range: Above 1GHz        Temperature : 24 °C  
 Test Result: PASS                      Humidity : 47 %  
 Measured Distance: 3m                Test By: Sance

Freq. (MHz)	Ant.Pol. (H/V)	Reading Level(dBuV)		Factor (dB/m)	Emission Level (dBuV)		Limit 3m (dBuV/m)		Margin (dB)	
		PK	AV		PK	AV	PK	AV	PK	AV
<b>The worst case: Test Mode: 802.11g</b>										
2390.000	H	58.04	45.75	0.13	58.17	45.88	74.00	54.00	-15.83	-8.12
2390.000	V	54.37	39.18	0.13	54.50	39.31	74.00	54.00	-19.50	-14.69
2483.560	H	63.69	50.22	0.35	64.04	50.57	74.00	54.00	-9.96	-3.43
2483.560	V	58.06	45.37	0.35	58.41	45.72	74.00	54.00	-15.59	-8.28

- Note:**
- (1) All Readings are Peak Value and AV.
  - (2) Emission Level= Reading Level+Probe Factor +Cable Loss
  - (3) Measurement uncertainty : ±3.7dB



**New antenna test results:**

Spurious Emission in restricted band:

Operation Mode: TX                      Test Date : November 10, 2022  
 Frequency Range: Above 1GHz        Temperature : 24 °C  
 Test Result: PASS                      Humidity : 47 %  
 Measured Distance: 3m                Test By: Sance

Freq. (MHz)	Ant.Pol. (H/V)	Reading Level(dBuV)		Factor (dB/m)	Emission Level (dBuV)		Limit 3m (dBuV/m)		Margin (dB)	
		PK	AV		PK	AV	PK	AV	PK	AV
<b>The worst case: Test Mode: 802.11g</b>										
2390.000	H	46.66	32.93	0.13	46.79	33.06	74.00	54.00	-27.21	-20.94
2390.000	V	47.35	32.43	0.13	47.48	32.56	74.00	54.00	-26.52	-21.44
2483.560	H	53.97	44.43	0.35	54.32	44.78	74.00	54.00	-19.68	-9.22
2483.560	V	56.26	48.55	0.35	56.61	48.90	74.00	54.00	-17.39	-5.10

- Note:**
- (1) All Readings are Peak Value and AV.
  - (2) Emission Level= Reading Level+Probe Factor +Cable Loss
  - (3) Measurement uncertainty : ±3.7dB

### Band Edge 802.11b Low Channel

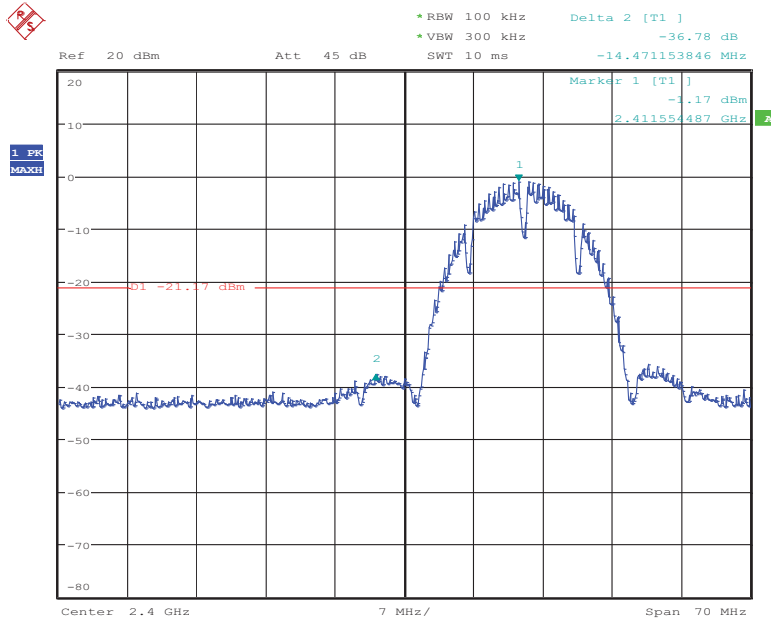

### 802.11b High Channel

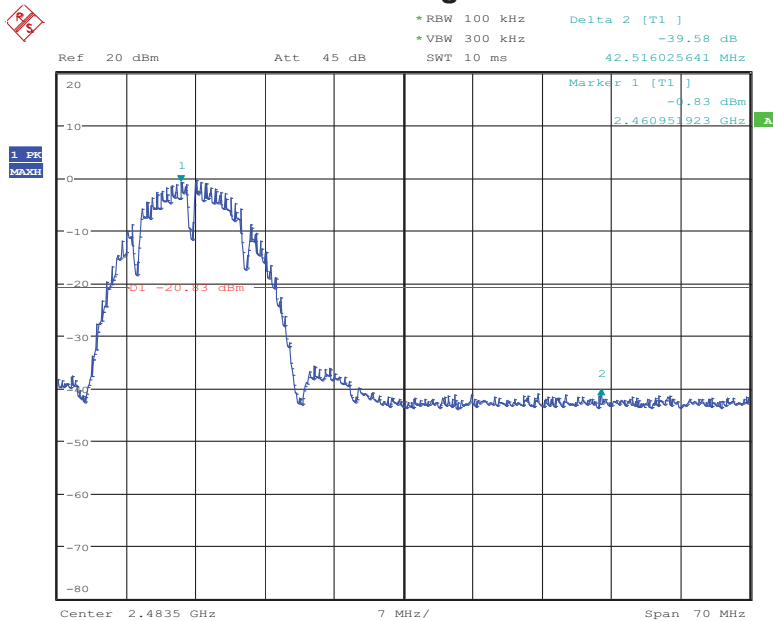

### 802.11g Low Channel

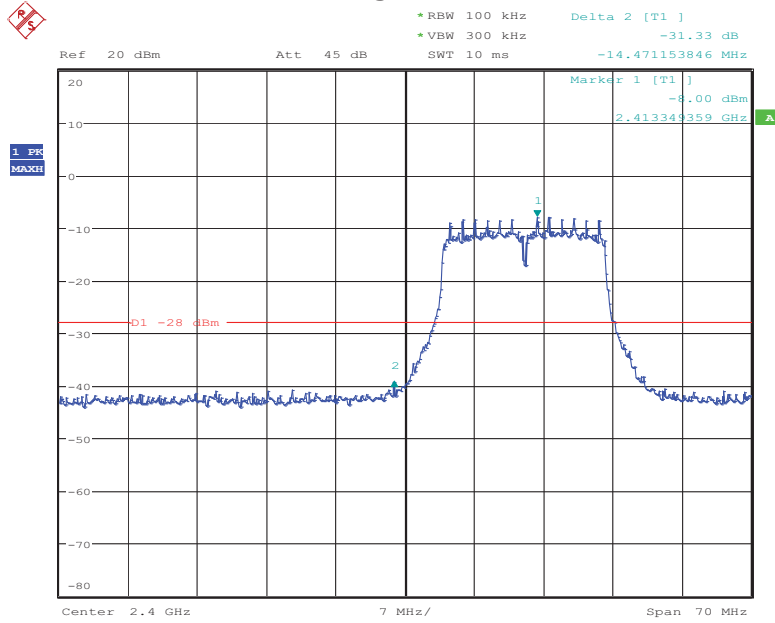

### 802.11g High Channel

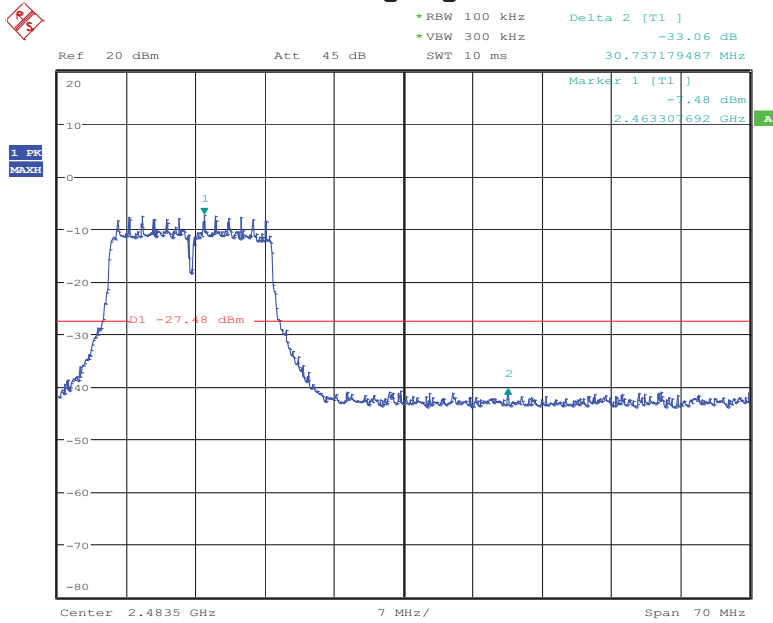

### 802.11n(HT20) Low Channel

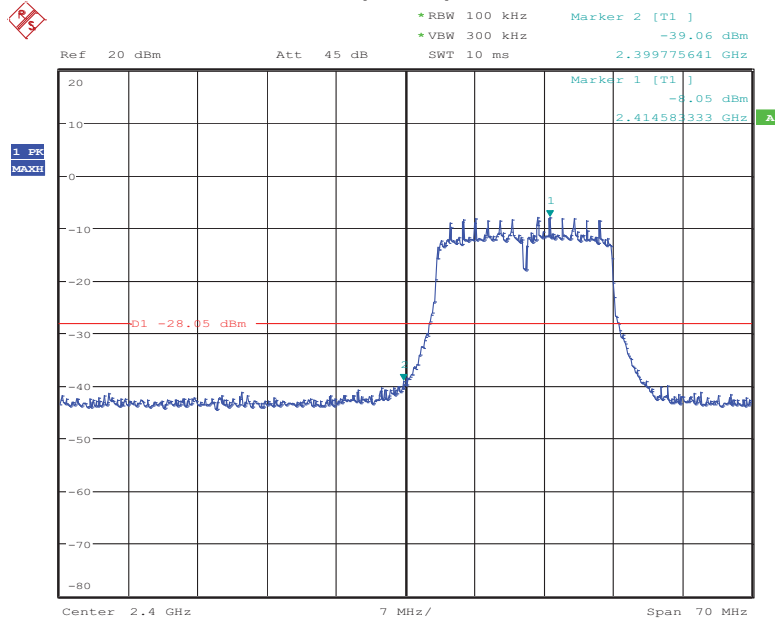

### 802.11n(HT20) High Channel

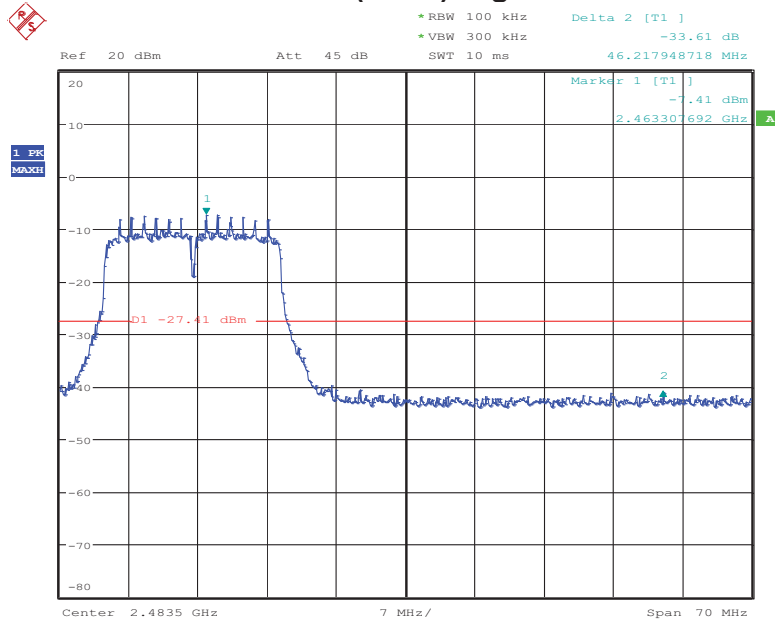

### 802.11n(HT40) Low Channel

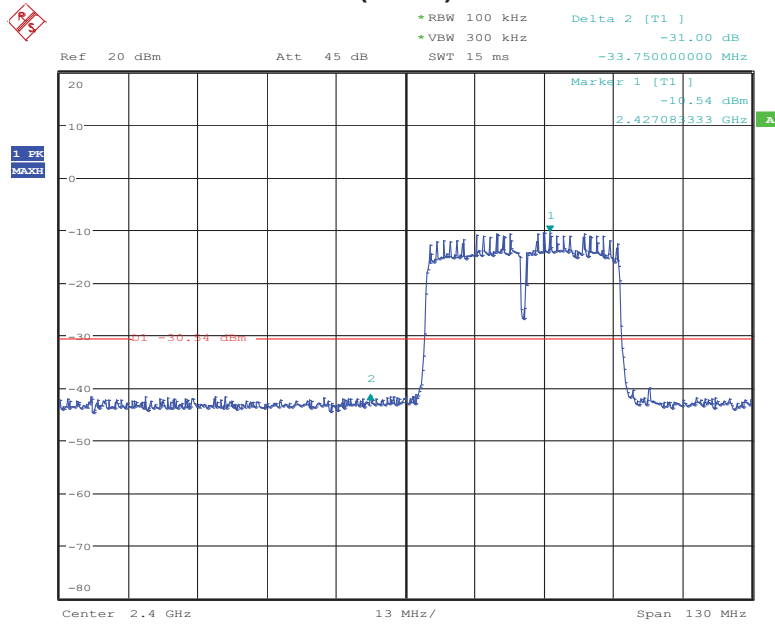

### 802.11n(HT40) High Channel

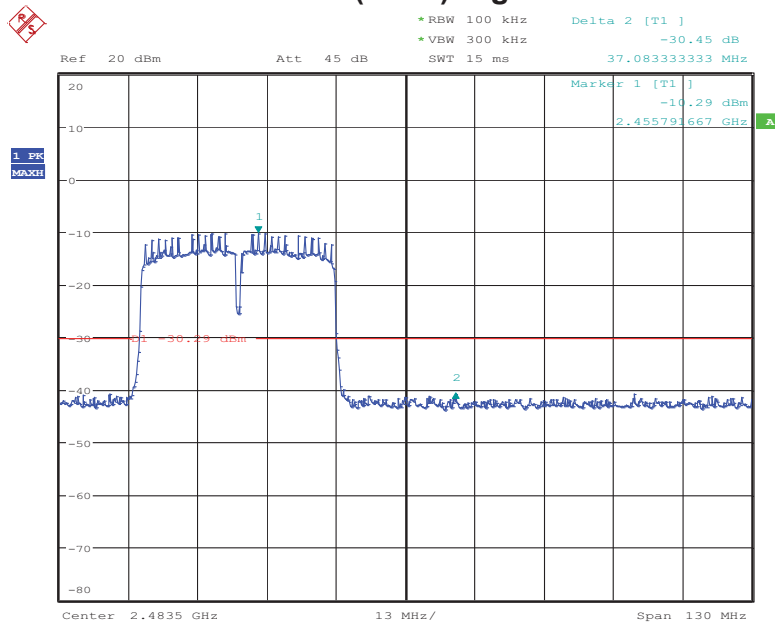

### Conducted Spurious Emissions The worst case: 802.11g Low Channel

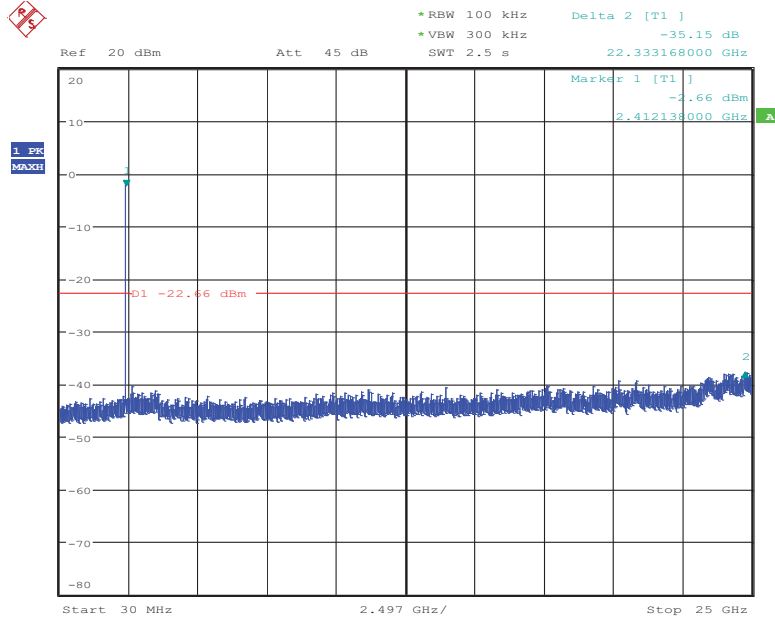

### Middle Channel

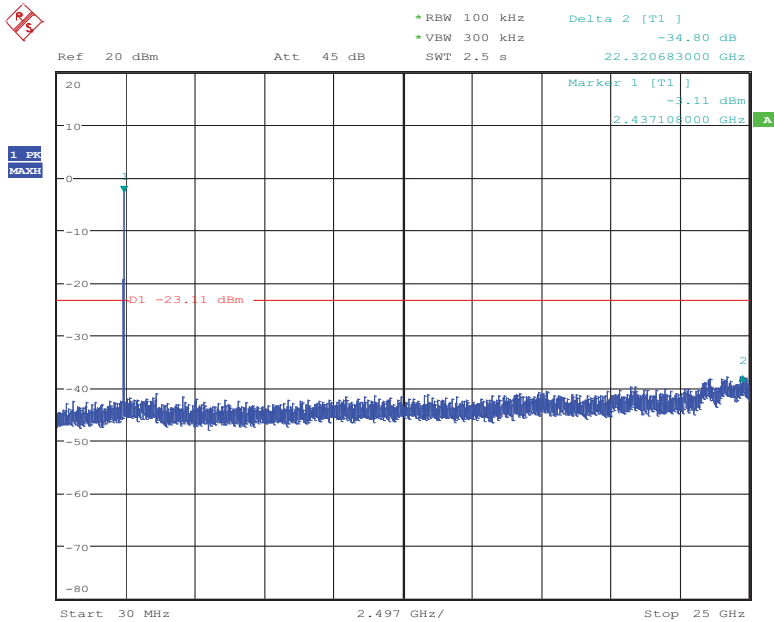



### High Channel

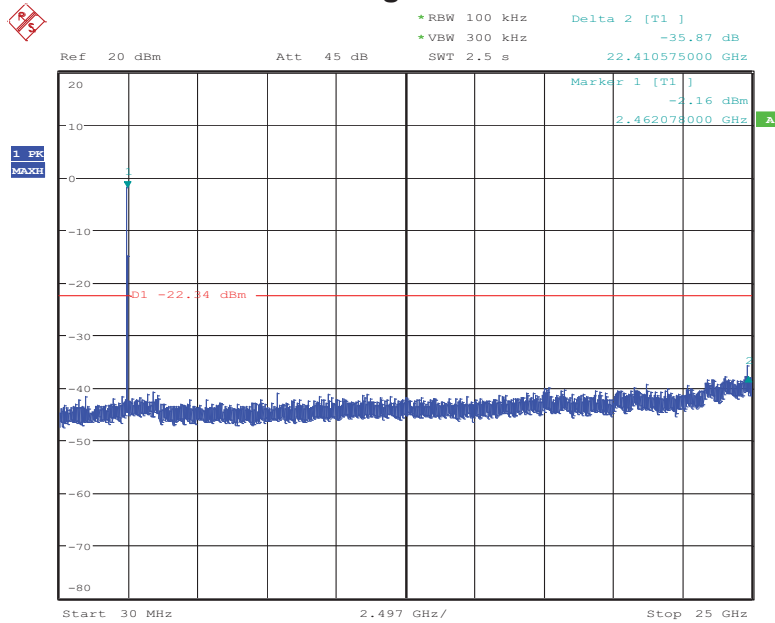

Note: Sweep points=30001pts

## 8. Radiated Spurious Emissions and Restricted Bands

### 8.1 Test SET-UP (Block Diagram of Configuration)

#### 8.1.1 Radiated Emission Test Set-Up, Frequency Below 30MHz

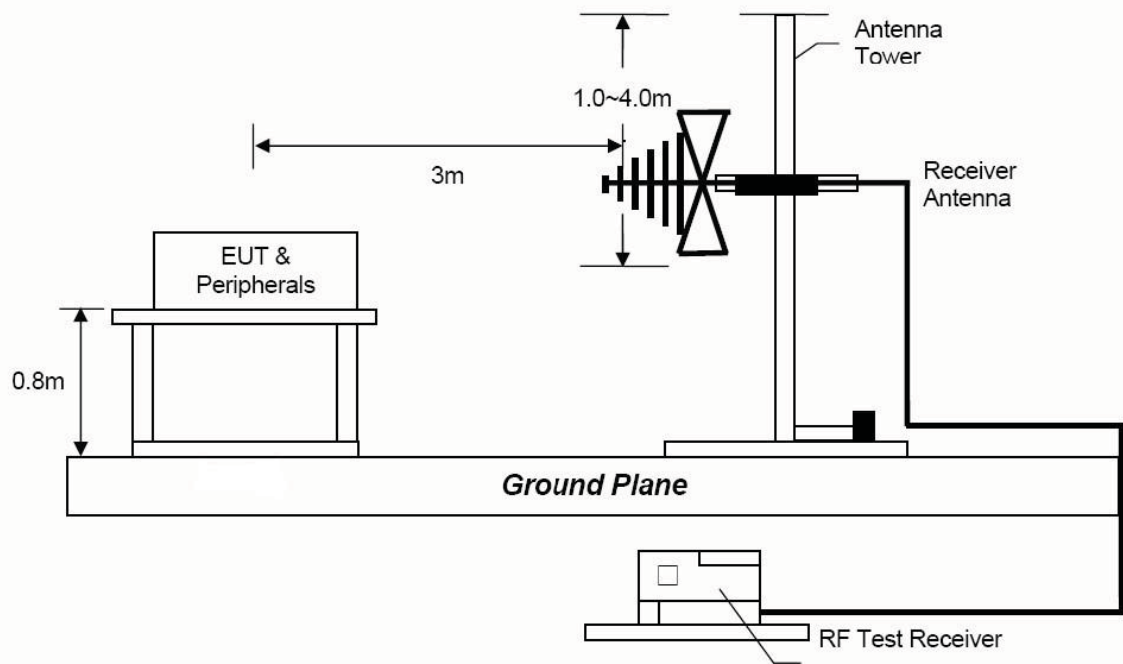
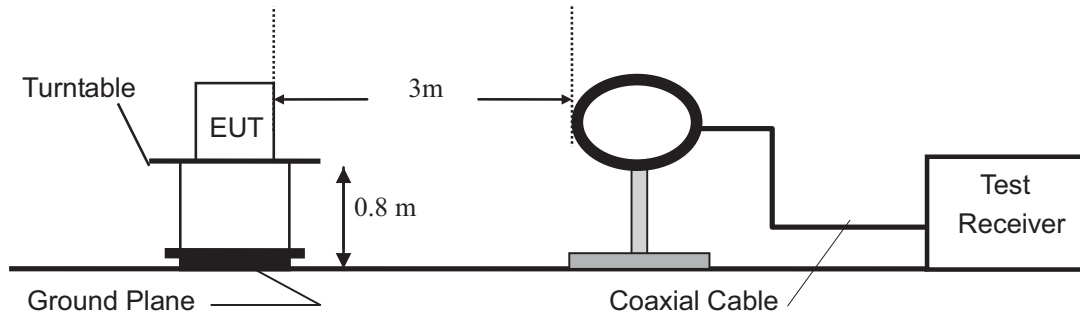

### 8.1.2 Radiated Emission Test Set-Up, Frequency above 1GHz

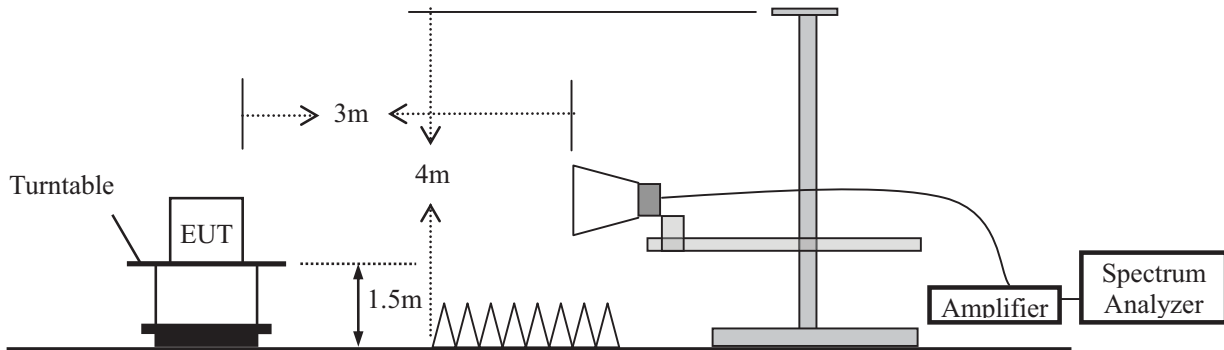

### 8.2 Measurement Procedure

- Blow 1GHz, the EUT was placed on the top of a rotating table 0.8 meters above the ground at a 3 meter semi- anechoic chamber room.
- For the radiated emission test above 1GHz:  
The EUT was placed on the top of a rotating table 1.5 meters above the ground at a 3 meter full anechoic chamber room. The table was rotated 360 degrees to determine the position of the highest radiation. Place the measurement antenna away from each area of the EUT determined to be a source of emissions at the specified measurement distance, while keeping the measurement antenna aimed at the source of emissions at each frequency of significant emissions, with polarization oriented for maximum response. The measurement antenna may have to be higher or lower than the EUT, depending on the radiation pattern of the emission and staying aimed at the emission source for receiving the maximum signal. The final measurement antenna elevation shall be that which maximizes the emissions. The measurement antenna elevation for maximum emissions shall be restricted to a range of heights of from 1 m to 4 m above the ground or reference ground plane.
- The EUT was set 3 meters away from the interference-receiving antenna, which was mounted on the top of a variable-height antenna tower.
- The height of antenna is varied from one meter to four meters above the ground to determine the maximum value of the field strength. Both horizontal and vertical polarizations of the antenna are set to make the measurement.
- For each suspected emission, the EUT was arranged to its worst case and then the antenna was tuned to heights from 1 meter to 4 meters and the rotatable table was turned from 0 degrees to 360 degrees to find the maximum reading. The test-receiver system was set to peak detect function and specified bandwidth with maximum hold mode.
- A Quasi-peak measurement was then made for that frequency point for below 1GHz test. PK and AV for above 1GHz emission test.



During the radiated emission test, the spectrum analyzer was set with the following configurations:

Frequency Band (MHz)	Level	Resolution Bandwidth	Video Bandwidth
30 to 1000	QP	120 kHz	300 kHz
Above 1000	Peak	1 MHz	3 MHz
	Average	1 MHz	10 Hz

### 8.3 Limit

Frequency range MHz	Distance Meters	Field Strengths Limit (15.209)
		$\mu\text{V/m}$
0.009 ~ 0.490	300	$2400/F(\text{kHz})$
0.490 ~ 1.705	30	$24000/F(\text{kHz})$
1.705 ~ 30	30	30
30 ~ 88	3	100
88 ~ 216	3	150
216 ~ 960	3	200
Above 960	3	500

- Remark :
- (1) Emission level (dB) $\mu\text{V}$  = 20 log Emission level  $\mu\text{V/m}$
  - (2) The smaller limit shall apply at the cross point between two frequency bands.
  - (3) As shown in 15.35(b), for frequencies above 1000MHz, the field strength limits are based on average detector, however, the peak field strength of any emission shall not exceed the maximum permitted average limits, specified above by more than 20dB under any condition of modulation.
  - (4) The frequency range scanned is from the lowest radio frequency signal generated in the device which is greater than 9 kHz to the tenth harmonic of the highest fundamental frequency or 40 GHz, whichever is lower.
  - (5) §15.247(d) specifies that emissions which fall in the restricted bands, as defined in §15.205 comply with radiated emission limits specified in §15.209.

### 8.4 Measurement Results

Please refer to following plots of the worst case (802.11g Mid Channel)

Original antenna test results



Dongguan NTC Co., Ltd.  
 Tel:+86-769-22022444 Fax:+86-769-22022799  
 Web: [Http://www.ntc-c.com](http://www.ntc-c.com)

Site: Radiation

Test Time: 2017-11-22 13:21:06

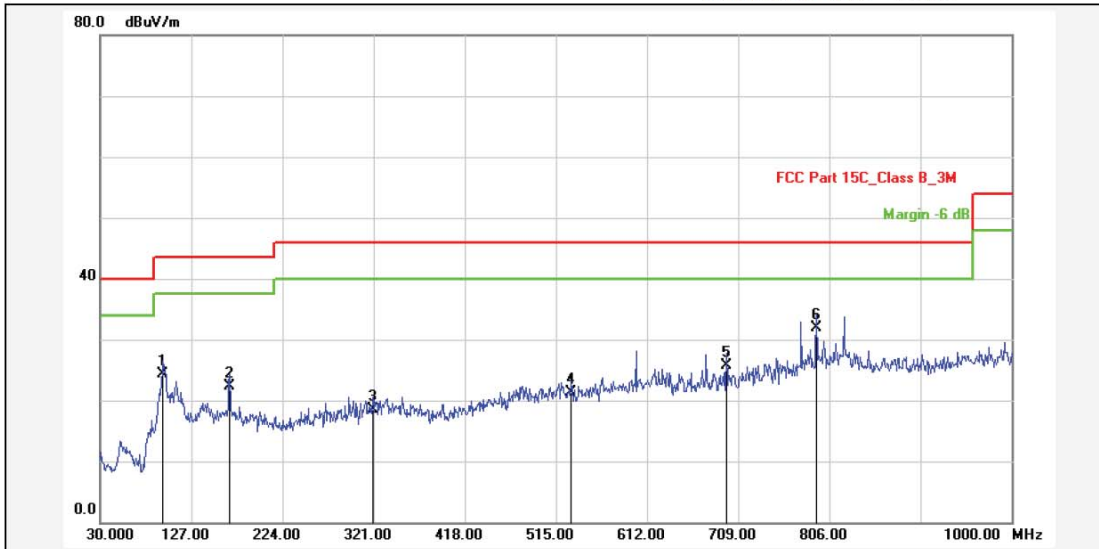

Report No.: 6223A-SRD  
 Test Standard: FCC Part 15C\_Class B\_3M  
 Test Item: Radiation Emission  
 Applicant: FN-LINK  
 Product: WIFI+BT combo Module  
 Model No.: 6223A-SRD  
 Test Distance: 3m  
 Ant. Polarization: Horizontal  
 Temp.(C)/Hum.(%): 25(C) / 51 %  
 Power Rating: AC 120V/60Hz  
 Test Engineer: Ivan

Test Mode: TX(Wi-Fi)  
 Remark: 802.11g Mid Channel

No.	Frequency (MHz)	Factor (dB/m)	Reading (dBuV)	Level (dBuV/m)	Limit (dBuV/m)	Margin (dB)	Detector	Height (cm)	Azimuth (deg.)	P/F	Remark
1	96.9300	-10.23	34.63	24.40	43.50	-19.10	QP			P	
2	167.7400	-12.63	34.93	22.30	43.50	-21.20	QP			P	
3	320.0300	-7.84	26.44	18.60	46.00	-27.40	QP			P	
4	531.4900	-4.31	25.61	21.30	46.00	-24.70	QP			P	
5	696.3900	-1.64	27.34	25.70	46.00	-20.30	QP			P	
6	792.4200	0.15	31.85	32.00	46.00	-14.00	QP			P	

Note: Level=Reading+Factor.

Margin=Limit-Level.

Note: Below 30MHz, the emissions are lower than 20dB below the allowable limit.



**Dongguan NTC Co., Ltd.**  
 Tel: +86-769-22022444 Fax: +86-769-22022799  
 Web: [Http://www.ntc-c.com](http://www.ntc-c.com)

Site: Radiation

Test Time: 2017-11-22 13:26:29

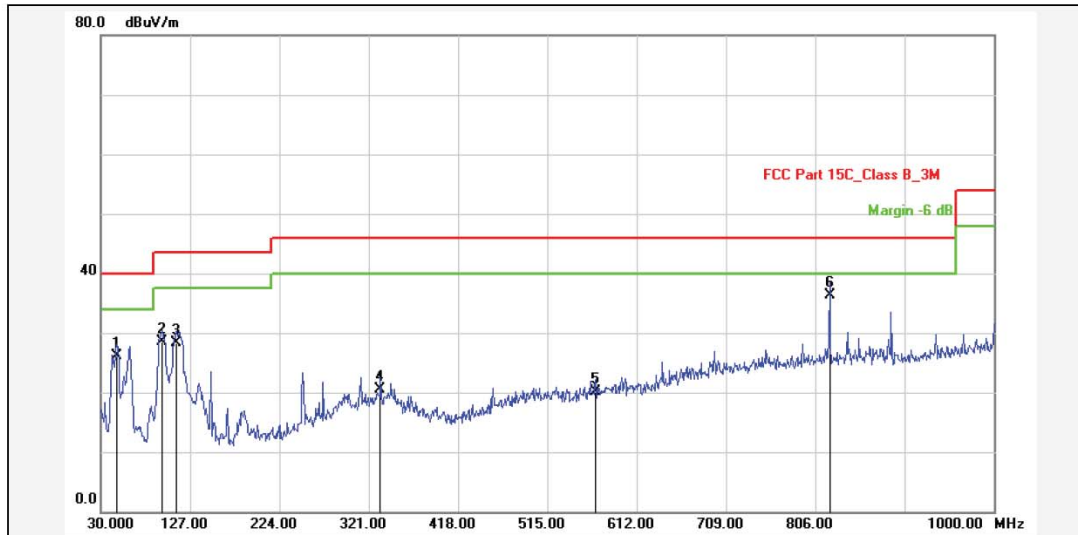

Report No.: 6223A-SRD  
 Test Standard: FCC Part 15C\_Class B\_3M  
 Test item: Radiation Emission  
 Applicant: FN-LINK  
 Product: WIFI+BT combo Module  
 Model No.: 6223A-SRD

Test Distance: 3m  
 Ant. Polarization: Vertical  
 Temp.(C)/Hum.(%): 25(C) / 51 %  
 Power Rating: AC 120V/60Hz  
 Test Engineer: Ivan

Test Mode: TX(Wi-Fi)  
 Remark: 802.11g Mid Channel

No.	Frequency (MHz)	Factor (dB/m)	Reading (dBuV)	Level (dBuV/m)	Limit (dBuV/m)	Margin (dB)	Detector	Height (cm)	Azimuth (deg.)	P/F	Remark
1	47.4600	-11.62	37.82	26.20	40.00	-13.80	QP			P	
2	96.9300	-13.61	42.21	28.60	43.50	-14.90	QP			P	
3	112.4500	-13.79	42.09	28.30	43.50	-15.20	QP			P	
4	333.6099	-9.52	30.12	20.60	46.00	-25.40	QP			P	
5	567.3800	-5.59	25.69	20.10	46.00	-25.90	QP			P	
6	821.5200	0.49	35.91	36.40	46.00	-9.60	QP			P	

Note: Level=Reading+Factor.  
 Margin=Limit-Level.

**Note: Below 30MHz, the emissions are lower than 20dB below the allowable limit.**

**New antenna test results**



Dongguan NTC Co., Ltd.  
 Tel:+86-769-2202 2444 Fax:+86-769-2202 2799  
 Web: [www.ntc-c.com](http://www.ntc-c.com)

Site: 3m Chamber	Polarization: <i>Horizontal</i>	Temperature: 26
Limit: FCC_Part 15C_3m	Power: DC 5V	Humidity: 47 %
EUT: WIFI+BT combo Module	Distance: 3m	
M/N: 6223A-SRD		
Mode: 2.4G (WIFI)		
Note:		

**Radiated Emission Measurement**

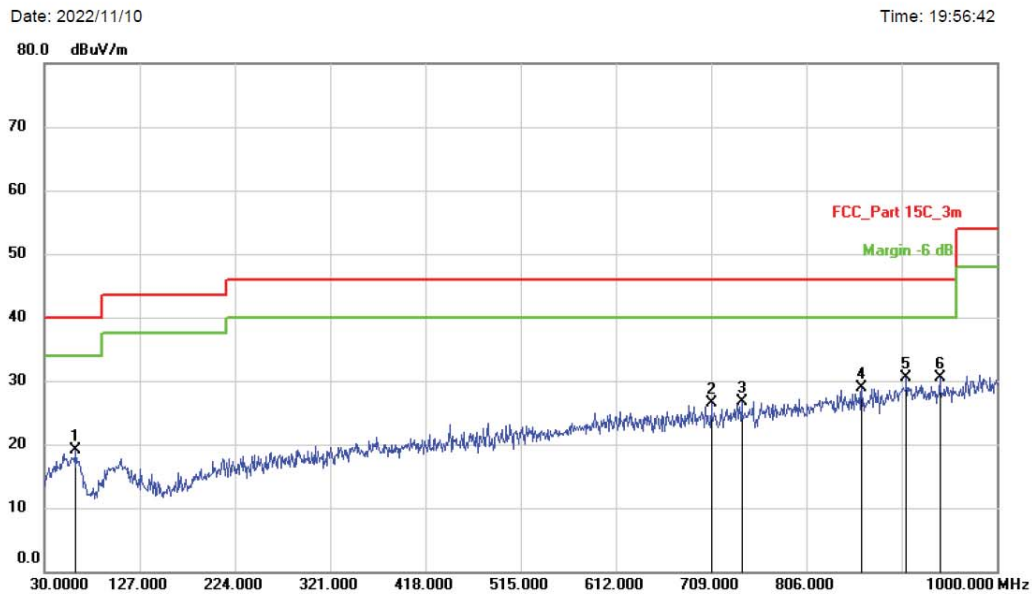

No.	Mk.	Freq.	Reading Level	Correct Factor	Measurement	Limit	Over	Detector	Comment
		MHz	dBuV	dB/m	dBuV/m	dBuV/m	dB		
1		62.0100	26.39	-7.29	19.10	40.00	-20.90	QP	
2		709.0000	24.16	2.34	26.50	46.00	-19.50	QP	
3		740.0400	23.91	2.87	26.78	46.00	-19.22	QP	
4		862.2600	23.98	4.88	28.86	46.00	-17.14	QP	
5		907.8500	24.21	6.22	30.43	46.00	-15.57	QP	
6	*	941.8000	24.28	6.26	30.54	46.00	-15.46	QP	

**Note: Below 30MHz, the emissions are lower than 20dB below the allowable limit.**





Dongguan NTC Co., Ltd.  
 Tel:+86-769-2202 2444 Fax:+86-769-2202 2799  
 Web: www.ntc-c.com

Site: 3m Chamber	Polarization: <i>Vertical</i>	Temperature: 26
Limit: FCC_Part 15C_3m	Power: DC 5V	Humidity: 47 %
EUT: WIFI+BT combo Module	Distance: 3m	
M/N: 6223A-SRD		
Mode: 2.4G (WIFI)		
Note:		

### Radiated Emission Measurement

Date: 2022/11/10

Time: 20:03:03

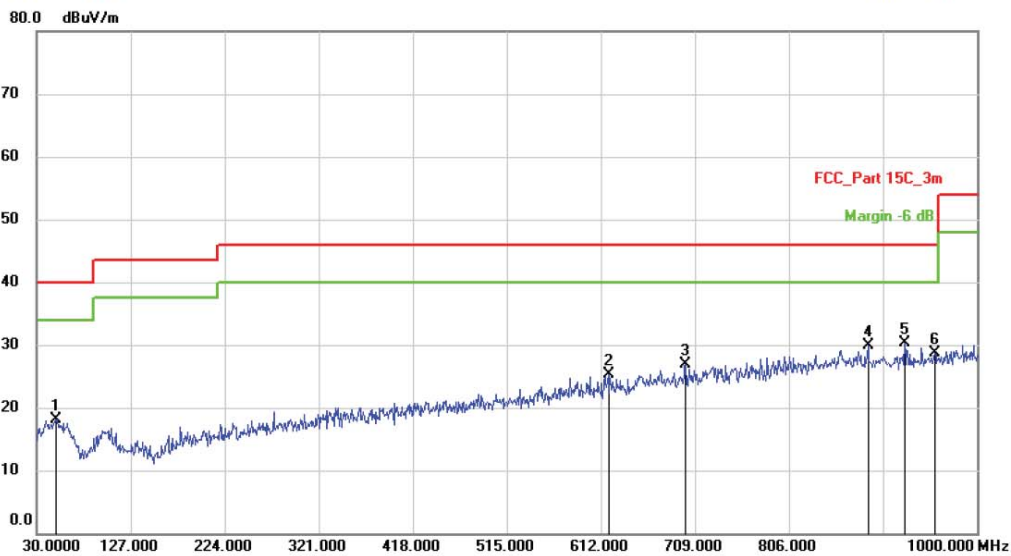

No. Mk.	Freq.	Reading Level	Correct Factor	Measurement	Limit	Over	Detector	Comment
	MHz	dBuV	dB/m	dBuV/m	dBuV/m	dB		
1	49.4000	25.06	-7.00	18.06	40.00	-21.94	QP	
2	619.7600	25.32	0.02	25.34	46.00	-20.66	QP	
3	699.3000	24.83	2.15	26.98	46.00	-19.02	QP	
4	887.4800	24.88	4.94	29.82	46.00	-16.18	QP	
5 *	925.3100	25.29	5.00	30.29	46.00	-15.71	QP	
6	956.3500	23.58	5.11	28.69	46.00	-17.31	QP	

**Note: Below 30MHz, the emissions are lower than 20dB below the allowable limit.**





**Original antenna test results:**

Test Mode: The worst case: Test Date : November 22, 2017  
 802.11g  
 Frequency Range: Above 1GHz Temperature : 25°C  
 Test Result: PASS Humidity : 51 %  
 Measured Distance: 3m Test By: Sance

Freq. (MHz)	Ant.Pol. (H/V)	Reading Level(dBuV)		Factor (dB/m)	Emission Level (dBUV)		Limit 3m (dBUV/m)		Margin (dB)	
		PK	AV		PK	AV	PK	AV	PK	AV
<b>Operation Mode: TX Mode (Low)</b>										
4824	V	55.09	41.03	6.38	61.47	47.41	74.00	54.00	-12.53	-6.59
7236	V	48.77	35.38	10.48	59.25	45.86	74.00	54.00	-14.75	-8.14
---										
4824	H	56.89	43.47	6.38	63.27	49.85	74.00	54.00	-10.73	-4.15
7236	H	50.34	37.57	10.48	60.82	48.05	74.00	54.00	-13.18	-5.95
---										
<b>Operation Mode: TX Mode (Mid)</b>										
4874	V	54.49	40.38	6.56	61.05	46.94	74.00	54.00	-12.95	-7.06
7311	V	47.70	34.63	10.53	58.23	45.16	74.00	54.00	-15.77	-8.84
---										
4874	H	57.20	43.62	6.56	63.76	50.18	74.00	54.00	-10.24	-3.82
7311	H	50.25	38.29	10.53	60.78	48.82	74.00	54.00	-13.22	-5.18
---										
<b>Operation Mode: TX Mode (High)</b>										
4924	V	54.38	40.27	6.76	61.14	47.03	74.00	54.00	-12.86	-6.97
7386	V	49.24	36.04	10.57	59.81	46.61	74.00	54.00	-14.19	-7.39
---										
4924	H	55.23	42.97	6.76	61.99	49.73	74.00	54.00	-12.01	-4.27
7386	H	49.72	38.34	10.57	60.29	48.91	74.00	54.00	-13.71	-5.09
---										

- Note:**
- (1) All Readings are Peak Value and AV.
  - (2) Emission Level= Reading Level + Factor
  - (3) Factor= Antenna Gain + Cable Loss – Amplifier Gain
  - (4) Data of measurement within this frequency range shown “ ---” in the table above means the reading of emissions are attenuated more than 10dB below the permissible limits.
  - (5) Measurement uncertainty : ±3.7dB.
  - (6) Horn antenna used for the emission over 1000MHz.



**New antenna test results:**

Test Mode: The worst case: Test Date : November 10, 2022  
 802.11g  
 Frequency Range: Above 1GHz Temperature : 25°C  
 Test Result: PASS Humidity : 51 %  
 Measured Distance: 3m Test By: Sance

Freq. (MHz)	Ant.Pol. (H/V)	Reading Level(dBuV)		Factor (dB/m)	Emission Level (dBuV)		Limit 3m (dBuV/m)		Margin (dB)	
		PK	AV		PK	AV	PK	AV	PK	AV
<b>Operation Mode: TX Mode (Low)</b>										
4824	V	48.67	42.49	6.38	55.05	48.87	74.00	54.00	-18.95	-5.13
7236	V	47.85	32.87	10.48	58.33	43.35	74.00	54.00	-15.67	-10.65
---										
4824	H	45.70	36.78	6.38	52.08	43.16	74.00	54.00	-21.92	-10.84
7236	H	46.07	31.76	10.48	56.55	42.24	74.00	54.00	-17.45	-11.76
---										
<b>Operation Mode: TX Mode (Mid)</b>										
4874	V	51.67	42.45	6.56	58.23	49.01	74.00	54.00	-15.77	-4.99
7311	V	45.68	32.35	10.53	56.21	42.88	74.00	54.00	-17.79	-11.12
---										
4874	H	46.10	37.19	6.56	52.66	43.75	74.00	54.00	-21.34	-10.25
7311	H	46.62	31.75	10.53	57.15	42.28	74.00	54.00	-16.85	-11.72
---										
<b>Operation Mode: TX Mode (High)</b>										
4924	V	48.05	42.04	6.76	54.81	48.80	74.00	54.00	-19.19	-5.20
7386	V	45.58	31.53	10.57	56.15	42.10	74.00	54.00	-17.85	-11.90
---										
4924	H	43.01	38.60	6.76	49.77	45.36	74.00	54.00	-24.23	-8.64
7386	H	41.66	30.76	10.57	52.23	41.33	74.00	54.00	-21.77	-12.67
---										

- Note:**
- (1) All Readings are Peak Value and AV.
  - (2) Emission Level= Reading Level + Factor
  - (3) Factor= Antenna Gain + Cable Loss – Amplifier Gain
  - (4) Data of measurement within this frequency range shown “ ---” in the table above means the reading of emissions are attenuated more than 10dB below the permissible limits.
  - (5) Measurement uncertainty : ±3.7dB.
  - (6) Horn antenna used for the emission over 1000MHz.

---

## 9. Antenna Application

### 9.1 Antenna requirement

According to of FCC part 15C section 15.203 and 15.240:

An intentional radiator shall be designed to ensure that no antenna other than that furnished by the responsible party shall be used with the device. The use of a permanently attached antenna or of an antenna that uses a unique coupling to the intentional radiator, the manufacturer may design the unit so that a broken antenna can be replaced by the user, but the use of a standard antenna jack or electrical connector is prohibited.

Systems operating in the 2400-2483.5MHz band that are used exclusively for fixed, point-to-point operations may employ transmitting antennas with directional gain greater than 6dBi provided the maximum peak output power of the intentional radiator is reduced by 1dB for every 3dB that the directional gain of the antenna exceeds 6dBi.

### 9.2 Measurement Results

For antenna is PIFA antenna that no antenna other than furnished by the responsible party shall be used with the device, and the best case gain of the antenna is 2.99dBi, For antenna is stamped metal antenna that no antenna other than furnished by the responsible party shall be used with the device, and the best case gain of the antenna is 4.9dBi, So, these antenna is consider meet the requirement.



## 10. Test Equipment List

Description	Manufacturer	Model Number	Serial Number	Characteristics	Calibration Date	Calibration Due Date
Test Receiver	Rohde & Schwarz	ESC17	100837	9KHz~7GHz	Mar. 14, 2017	Mar. 13, 2018
Antenna	Schwarzbeck	VULB9162	9162-010	30MHz~7GHz	Mar. 15, 2017	Mar. 14, 2018
Cable	Huber+Suhner	CBL2-NN-1M	22390001	9KHz~7GHz	Mar. 14, 2017	Mar. 13, 2018
Cable	Huber+Suhner	CIL02	N/A	9KHz~7GHz	Mar. 14, 2017	Mar. 13, 2018
RF Cable	Huber+Suhner	SF-104	MY16559/4	9KHz~25GHz	Apr. 25, 2017	Apr. 25, 2018
Power Amplifier	HP	HP 8447D	1145A00203	100KHz~1.3GHz	Mar. 14, 2017	Mar. 13, 2018
Horn Antenna	Schwarzbeck	BBHA9170	9170-242	15GHz~40GHz	Mar. 14, 2017	Mar. 13, 2018
Horn Antenna	Com-Power	AH-118	071078	1GHz~18GHz	Mar. 15, 2017	Mar. 14, 2018
RF Cable	Huber+Suhner	SF-104	N/A	9KHz~40GHz	Apr. 25, 2017	Apr. 24, 2018
Loop antenna	Daze	ZA30900A	0708	9KHz~30MHz	Apr. 25, 2017	Apr. 24, 2018
Spectrum Analyzer	Rohde & Schwarz	FSU26	200409/026	20Hz~26.5GHz	Apr. 25, 2017	Apr. 24, 2018
Spectrum Analyzer	Rohde & Schwarz	FSV40	101003	10Hz~40GHz	April. 06, 2017	April. 05, 2018
Pre-Amplifier	EMCI	EMC 184045	980102	18GHz~40GHz	Nov. 03, 2017	Nov. 02, 2018
Pre-Amplifier	Agilent	8449B	3008A02964	1GHz~26.5GHz	Apr. 25, 2017	Apr. 24, 2018
L.I.S.N.	Rohde & Schwarz	ENV 216	101317	9KHz~30MHz	Mar. 14, 2017	Mar. 13, 2018
Temporary antenna connector	TESCOM	SS402	N/A	9KHz-25GHz	N/A	N/A
Power Meter	Anritsu	ML2495A	1139001	100k-65GHz	Nov. 03, 2017	Nov. 02, 2018
Power Sensor	Anritsu	MA2411B	100345	300M-40GHz	Nov. 03, 2017	Nov. 02, 2018



Item	Equipment	Manufacturer	Model No.	Serial No.	Last Cal.	Cal. Interval
1.	Test Receiver	Rohde & Schwarz	ESCI7	100837	Mar. 13, 2022	1 Year
2.	Antenna	Schwarzbeck	VULB9162	9162-010	Mar. 23, 2022	2 Year
3.	Spectrum Analyzer	Rohde & Schwarz	FSU26	200409/026	Mar. 13, 2022	1 Year
4.	Spectrum Analyzer	Keysight	N9020A	MY54200831	Mar. 13, 2022	1 Year
5.	Spectrum Analyzer	Rohde & Schwarz	FSV40	101094	Mar. 13, 2022	1 Year
6.	Horn Antenna	Schwarzbeck	BBHA9170	9170-172	Mar. 23, 2022	2 Year
7.	Power Sensor	DARE	RPR3006W	15100041SNO 64	Mar. 13, 2022	1 Year
8.	Communication Tester	Rohde & Schwarz	CMW500	149004	Mar. 13, 2022	1 Year
9.	Horn Antenna	COM-Power	AH-118	071078	Mar. 23, 2022	2 Year
10.	Pre-Amplifier	HP	HP 8449B	3008A00964	Mar. 13, 2022	1 Year
11.	Pre-Amplifier	HP	HP 8447D	1145A00203	Mar. 13, 2022	1 Year
12.	Loop Antenna	Schwarzbeck	FMZB 1513	1513-272	Mar. 23, 2022	2 Year
13.	Test Receiver	Rohde & Schwarz	ESCI	101152	Mar. 13, 2022	1 Year
14.	L.I.S.N	Rohde & Schwarz	ENV 216	101317	Mar. 13, 2022	1 Year
15.	L.I.S.N	Rohde & Schwarz	ESH2-Z5	893606/014	Mar. 13, 2022	1 Year
16.	RF Switching Unit	Compliance Direction Systems Inc.	RSU-M2	38311	Mar. 13, 2022	1 Year
17.	Temperature & Humidity Chamber	REMAFEE	SYHR225L	N/A	Mar. 13, 2022	1 Year
18.	DC Source	Maynuo	MY8811	N/A	Mar. 13, 2022	1 Year
19.	Temporary antenna connector	TESCOM	SS402	N/A	N/A	N/A
20.	Chamber	SAEMC	9*7*7m	N/A	Apr. 21, 2021	2 Year
21.	Test Software	EZ	EZ_EMCC	N/A	N/A	N/A

Note: The temporary antenna connector is soldered on the PCB board in order to perform conducted tests and this temporary antenna connector is listed in the equipment list.

---End---