

SM-62674 multifunctional Bluetooth speaker clock wireless charging product operating instructions

1. Appearance picture

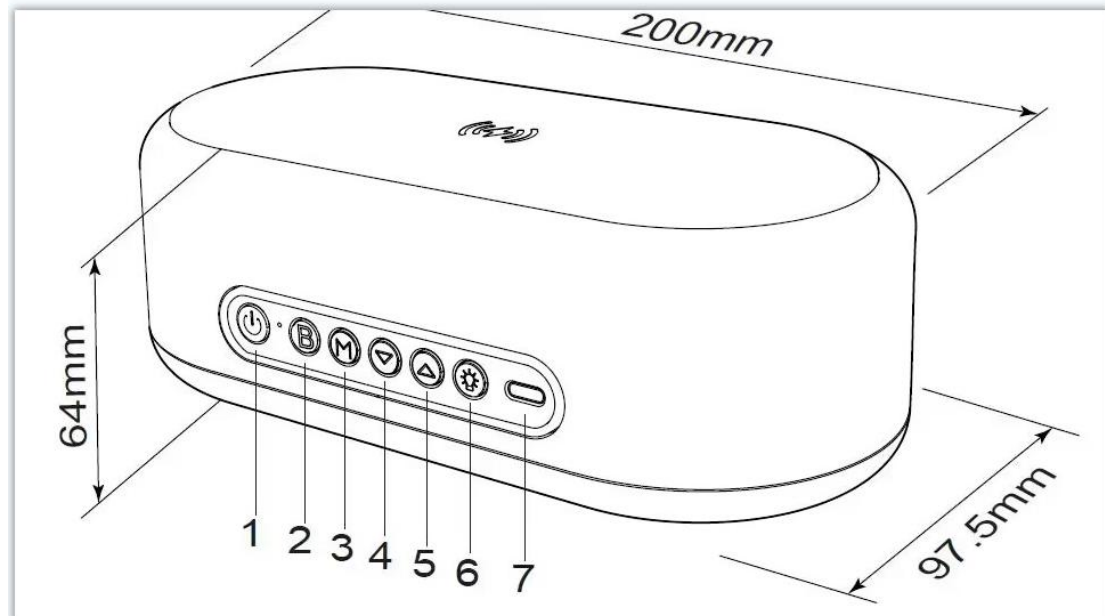

2. Power supply: 2.1 Insert the USB end of the charging cable into the power adapter, and insert the Type-C port into this product, and the red power indicator light will be on. 2.2 The product enters the normal working state, and enters the standby state after all the indicators are lit. The default is 06:00. After connecting Bluetooth, the Apple Watch automatically synchronizes the mobile phone time (not supported by Android phones). 2.3 The temperature detection starts to work, and the temperature value is displayed.

3. Wireless charging part:

3.1 Output power: 15W

3.2 Indication mode of indicator light: Turn on the power supply, turn to standby, and turn off the light; Charging: the green light is always on; Full: do not turn the light; FOD: The red light is flashing.

3.3 The WPT function will only work if the adapter is connected.

3.4 Specification parameters: Input: 5V/3A 9V/3A

Wireless charging and outputting power: 15W(MAX)

Charging efficiency: 75%

Wireless charging transmission distance: $\leq 5-8$ mm

Power adapter: QC3.0, 9V/3A

Horn power: 5W*2

Battery capacity: 3.7V 1200mAh

LED function: 3W

Product size: 200*97.5*64MM

4. Some settings of clock, year and date:





4.1 Key function: 6 keys (from left to right: power supply, Bluetooth speaker on-off key, clock mode, next/volume down key, previous/volume up key, light key).

4.2 On/off  function: press the power button for more than 2 seconds to turn on/off the clock.

4.3 4.3 Time setting:  press the short key to enter the time/alarm clock/date setting, which will be repeated, and automatically exit and save after 5 seconds without operation. When the Bluetooth speaker of Apple mobile phone is turned on, the time and date of the mobile phone will be automatically synchronized after the mobile phone is connected;

(1) Time setting:  press the key to enter: year (default 2021)→ date (month, day, default 01,01)→ select 12H/24H system → time (hour → minute) → cycle. Two points in the middle second and related setting numbers flash at the same time. Press the Δ / ∇ key to add or subtract the hour value, and automatically exit and save if there is no operation within 10 seconds.

(2) Double-click the  key to turn on the alarm clock and display the set time of the alarm clock, and turn off the alarm clock, and press and hold the  key to enter the set time of the alarm clock;

(3) Alarm clock sound: ring (double "drip" sound, once every second) for 5 minutes; Automatic closing after ringing;

(4) When the alarm clock rings, short press any  key to pause the alarm clock and enter the snooze, which will ring once every 10 minutes. Double-click the key to turn off the alarm clock;

(5) When the alarm clock rings, the alarm clock indicator flashes at the same time: it turns on and off once every second;

5. System switching:

5.1 Temperature system switching: short press the ∇ key to switch Fahrenheit and Celsius systems. Long press the ∇ key for 2 seconds to switch sp1/sp2(sp1 is the screen-rest mode, which can be awakened by voice control after the screen is turned off). (In pure clock mode, Bluetooth is turned on, which is the next function.)

5.2 Display mode switching: short press Δ to switch the display mode (dp1/dp2). (dp1 mode displays time-year-date automatically)

6. Switching on and off the ambient light:

6.1 Ambient light: short press the  key to turn on the ambient light and switch the light, in turn: high light (100%), medium light (50%) and low light (25%);

6.2 The default is to highlight.

7, Bluetooth speaker

7.1 Long-press  switch Bluetooth speaker function, which has a prompt tone after startup, and enters the state to be connected after startup. At this time, the Bluetooth logo is flashing. At this time, you can turn on Bluetooth on the mobile phone to enter search and connect. The Bluetooth name is AL-Y12, and the Bluetooth logo is in the long light state after connection.

7.2 After connecting the Bluetooth speaker, press the Δ/∇ key briefly to adjust the volume, and press the Δ/∇ key long to switch up and down.

7.3 The long  button can be used for general shutdown, and all functions are turned off. If the alarm clock is turned on, it will ring normally after shutdown.

7.4 Bluetooth is effectively connected for 10 meters. Bluetooth is turned off after 3 minutes without connection.

FCC Warning:

This transmitter must not be co-located or operating in conjunction with any other antenna or transmitter.

Any Changes or modifications not expressly approved by the party responsible for compliance could void the user's authority to operate the equipment.

This device complies with part 15 of the FCC Rules. Operation is subject to the following two conditions: (1) This device may not cause harmful interference, and (2) this device must accept any interference received, including interference that may cause undesired operation

Note: This equipment has been tested and found to comply with the limits for a Class B digital device, pursuant to part 15 of the FCC Rules. These limits are designed to provide reasonable protection against harmful interference in a residential installation. This equipment generates, uses and can radiate radio frequency energy and, if not installed and used in accordance with the instructions, may cause harmful interference to radio communications. However, there is no guarantee that interference will not occur in a particular installation. If this equipment does cause harmful interference to radio or television reception, which can be determined by turning the equipment off and on, the user is encouraged to try to correct the interference by one or more of the following measures:

- Reorient or relocate the receiving antenna.
- Increase the separation between the equipment and receiver.
- Connect the equipment into an outlet on a circuit different from that to which the receiver is connected.
- Consult the dealer or an experienced radio/TV technician for help.

RF Exposure Statement:

This equipment complies with FCC radiation exposure limits set forth for an uncontrolled environment.

For BT function:

This equipment should be used in portable exposure condition without restriction.

For WPT function:

This equipment should be installed and operated with minimum distance 20cm between the radiator & your body.