

Test Report No.:		18052904A.r02	Page 1 of 36
<i>Client:</i>	Tacx b.v. Rijksstraatweg 52, 2241BW Wassenaar, Netherlands		
<i>Test Item:</i>	Flux 2 Smart ANT		
<i>Identification:</i>	T2980	<i>Serial Number:</i>	871950010 (radiated) and 871950016 (AC powerline)
<i>Project No.:</i>	18052904A	<i>Date of Receipt:</i>	May 03, 2019
<i>Testing Location:</i>	TÜV Rheinland Nederland B.V. Eiberkamp 10 9351VT Leek		
<i>Test Specification:</i>	FCC 47 CFR Part 15, Subpart C, Section 15.247 (10-1-18 Edition) RSS-Gen (Issue 5, April 2018) and RSS-247 (Issue 2, February 2017) ANSI C63.10-2013		
<i>Test Result:</i>	The test item passed the test specification(s).		
<i>Testing Laboratory:</i>	TÜV Rheinland Nederland B.V. Eiberkamp 10 9351 VT Leek		
<i>Tested by:</i>			<i>Reviewed by:</i>
2019-05-20	R. van der Meer / Inspector	2019-05-20	E. van der Wal / Reviewer
<i>Date</i>	<i>Name/Position</i>	<i>Signature</i>	<i>Date</i>
			<i>Name/Position</i>
			<i>Signature</i>
<i>Other Aspects:-.</i>			
Abbreviations: <i>P</i> (ass) = <i>passed</i> <i>F</i> (ail) = <i>failed</i> <i>N/A</i> = <i>not applicable</i> <i>NT</i> = <i>not tested</i>			
This report shall not be reproduced, except in full, without the written permission of TÜV Rheinland Nederland B.V. The test results relate only to the item(s) tested.			

Test Report No.:

18052904A.r02

Page 2 of 36

TEST SUMMARY

5.1.1 20 dB AND 99% BANDWIDTH

RESULT: PASS

5.1.2 RADIATED SPURIOUS EMISSIONS OF TRANSMITTER

RESULT: Pass

5.2.1 AC POWER LINE CONDUCTED EMISSION OF TRANSMITTER

RESULT: Pass

Contents

1.	GENERAL REMARKS	4
1.1	COMPLEMENTARY MATERIALS	4
2.	TEST SITES	4
2.1	TEST FACILITIES	4
2.2	LIST OF TEST AND MEASUREMENT INSTRUMENTS TABLE 1: LIST OF TEST AND MEASUREMENT EQUIPMENT.....	5
2.3	MEASUREMENT UNCERTAINTY	6
3.	GENERAL PRODUCT INFORMATION.....	7
3.1	PRODUCT FUNCTION AND INTENDED USE.....	7
3.2	SYSTEM DETAILS	7
3.3	COUNTERMEASURES TO ACHIEVE COMPLIANCE	8
4.	TEST SET-UP AND OPERATION MODES	9
4.1	TEST METHODOLOGY	9
4.2	OPERATION MODES	9
4.3	PHYSICAL CONFIGURATION FOR TESTING	10
4.4	TEST SOFTWARE	12
4.5	SPECIAL ACCESSORIES AND AUXILIARY EQUIPMENT	13
5.	TEST RESULTS	14
5.1.1	<i>20dB and 99% Bandwidth.....</i>	<i>14</i>
5.1.2	<i>Radiated Spurious Emissions of Transmitter.....</i>	<i>19</i>
	<i>Plots of the radiated emissions</i>	<i>23</i>
5.2	AC POWER LINE CONDUCTED MEASUREMENTS.....	32
5.2.1	<i>AC Power Line Conducted Emission of Transmitter.....</i>	<i>33</i>
5.2.2	<i>Plots of the AC Power-line Conducted Emissions</i>	<i>34</i>

Test Report No.:

18052904A.r02

Page 4 of 36

1. General Remarks

1.1 Complementary Materials

There is no attachment to this test report.

2. Test Sites

2.1 Test Facilities

The Federal Communications Commission and Industry Canada has reviewed the technical characteristics of the test facilities at TÜV Rheinland Nederland B.V., located in Leek, 9351VT Eiberkamp 10, The Netherlands, and has found these test facilities to be in compliance with the requirements of 47 CFR Part 15, section 2.948.

The description of the test facilities has been filed at the Office of the Federal Communications Commission under registration number 786213. The facility has been added to the list of laboratories performing these test services for the public on a fee basis.

The description of the test facilities has been filed to Industry Canada under registration number 2932G-2. The facility has been added to the list of laboratories performing these test services for the public on a fee basis.

Normal test conditions:

Temperature (*) : +15°C to +35°C
Relative humidity(*) : 20 % to 75 %
Supply voltage : 120 VAC.

()When it was impracticable to carry out the tests under these conditions, a note to this effect stating the ambient temperature and relative humidity during the tests are stated separately.*

2.2 List of Test and Measurement Instruments

Table 1: List of Test and Measurement Equipment

Kind of Equipment	Manufacturer	Model Name	Inventory number	Calibration date (mm/yyyy)	Calibration due date (mm/yyyy)
For Radiated Emissions					
Measurement Receiver	Rohde & Schwarz	ESCI	A00314	03/2019	03/2020
RF Cable S-AR	Gigalink	APG0500	A00447	03/2019	03/2020
Controller	Maturo	SCU/088/ 8090811	A00450	N/A	N/A
Controller	EMCS	DOC202	A00257	N/A	N/A
Test facility	Comtest	FCC listed: 786213 IC: 2932G-2	A00235	10/2017	10/2020
Spectrum Analyzer	Rohde & Schwarz	FSV	A00337	07/2018	07/2019
Antenna mast	EMCS	AP-4702C	A00258	N/A	N/A
Temperature-Humiditymeter	Extech	SD500	A00444	06/2018	06/2019
Guidehorn 1-18 GHz	EMCO	3115	A00008	12/2017	12/2020
Guidehorn 18-40 GHz	EMCO	RA42-K-F-4B-C	A00012	01/2018	01/2021
Biconilog Testantenna	Teseq	CBL 6111D	A00466	11/2018	11/2019
2.4 GHz bandreject filter	BSC	XN-1783	A00065	N/A	N/A
Bandpass filter 4-10 GHz	Reactel	7AS-7G-6G- 511	A00131	N/A	N/A
Bandpass filter 10-26 GHz	Reactel	9HS- 10G/26.5G- S11	A00151	N/A	N/A
Preamplifier 0.5 - 18 GHz	Miteq	AMF-5D- 005180-28- 13p	A00247	N/A	N/A
Filterbox	EMCS	RFS06S	A00255	04/2018	04/2020



Test Report No.:

18052904A.r02

Page 6 of 36

Kind of Equipment	Manufacturer	Model Name	Inventory number	Calibration date (mm/yyyy)	Calibration due date (mm/yyyy)
For AC Powerline Conducted Emissions					
Pulse limiter	R&S	ESH3-Z2	A00051	11/2018	11/2019
Variac	RFT	LSS020	A00171	NA	NA
LISN	Rohde & Schwarz	ESH2-Z5	A00019	06/2018	06/2020
Measurement Receiver	Rohde & Schwarz	ESCS30	2789421 (A00726)	06/2018	06/2019
RF Cable	-	-	A01844	NA	NA
Shielded room for Conducted emissions	--	--	A00437	NA	NA
Temperature-Humidity meter	Extech	SD500	A00441	06/2018	06/2019

Conformance of the used measurement and test equipment with the requirements of ISO/IEC 17025:2005 has been confirmed before testing. NA= Not Applicable

2.3 Measurement Uncertainty

Table 2: Emission Measurement Uncertainty

Measurement Type	Frequency	Uncertainty
Radiated Emission	150kHz - 30MHz	±5.0dB
	30MHz - 1GHz	±5.22dB
	> 1GHz	±5.22dB
AC Power Line Conducted Emissions	150kHz - 30MHz	±3.6dB

3. General Product Information

3.1 Product Function and Intended Use

The brand Tacx model T2980, hereafter referred to as EUT, is an ANT+ transmitter used in a Flux 2 Smart with Electric Motor Brake for bicycles to transmit performance data to PC, Tablet or smartphone. The transmitter will support and utilizes GFSK modulation techniques. Although the chip used is capable of multiple data-rates only 1 Mbps is used. The EUT also contains a Digital Transmission System (DTS) operating in the frequencyband 2403-2480 MHz, based on BLE technology. The BLE transceiver is covered in a separate test report.

The content of this report and measurement results have not been changed other than the way of presenting the data.

3.2 System Details

Details and an overview of the system and all of its components, as it has been tested, may be found below.

Manufacturer	:	Tacx b.v.
Brand	:	Tacx
Model(s)	:	T2980
Voltage input rating	:	100 - 240 Vac
Voltage output rating	:	--
Current input rating	:	--
Antenna	:	Internal, integrated on the PCB
Antenna Gain	:	+ 2.0 dBi
Operating frequency	:	2403 MHz-2480 MHz.
Modulation	:	GFSK
Data-rate	:	1 Mbps
Remarks	:	n.a.

Test Report No.:

18052904A.r02

Page 8 of 36

Table 3: Interfaces present on the EUT

There are no interface ports present on the EUT.

3.3 Countermeasures to achieve compliance

No additional measures were employed to achieve compliance.

4. Test Set-up and Operation Modes

4.1 Test Methodology

The test methodology used is based on the requirements of RSS-GEN, 47 CFR Part 15, Sections 15.31, 15.33, 15.35, 15.205, 15.207, 15.209, 15.249.

The test methods, which have been used, are based on ANSI C63.10-2013.

4.2 Operation Modes

Testing was performed at the lowest operating frequency (2403 MHz), at the operating frequency in the middle of the specified frequency band (2442 MHz) and at the highest operating frequency (2480 MHz). These operation modes were selected after review of the capabilities and characteristics of the EUT. The test software as mentioned in section 4.4 enabled the settings of these modes.

The EUT has been tested in the modes as described in table below

Operation Mode	EUT Status	Frequency (MHz)	TX power control setting
Transmit (Tx)	On	2403	0
Transmit (Tx)	On	2442	0
Transmit (Tx)	On	2480	0

4.3 Physical Configuration for Testing

For programming purposes only the EUT was connected to the usb port of a laptop computer. The laptop computer was used to configure the EUT to continuously transmit at a specified output power and channel as specified in the test data. See section 4.5 for Auxiliary details.

The justification and manipulation of cables and equipment in order to simulate a worst-case behavior of the test setup has been carried out as prescribed in ANSI C63.10-2013.

Figure 1a: Test Setup Diagram –programming.

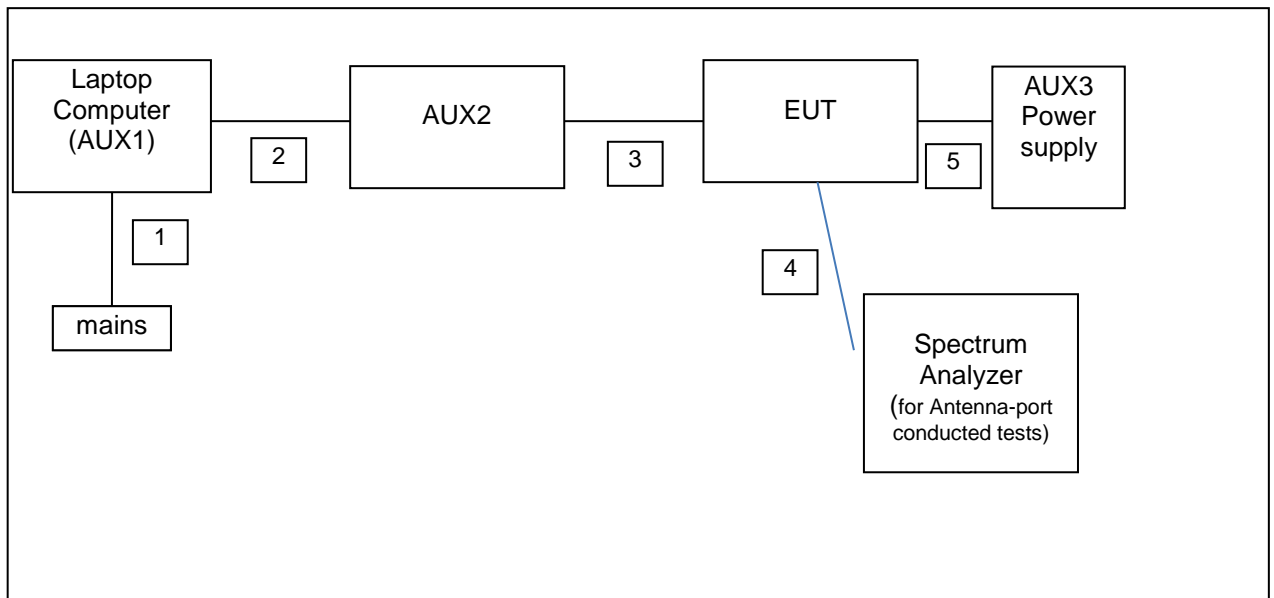

No.	Port	From	To	Remarks
1.	Mains	Mains	Laptop (AUX1)	Through a power supply
2.	Data com.	Laptop USB	AUX2	--
3.	Data com.	AUX2	EUT	--
4.	Power supply	AUX3	EUT	40 Vac

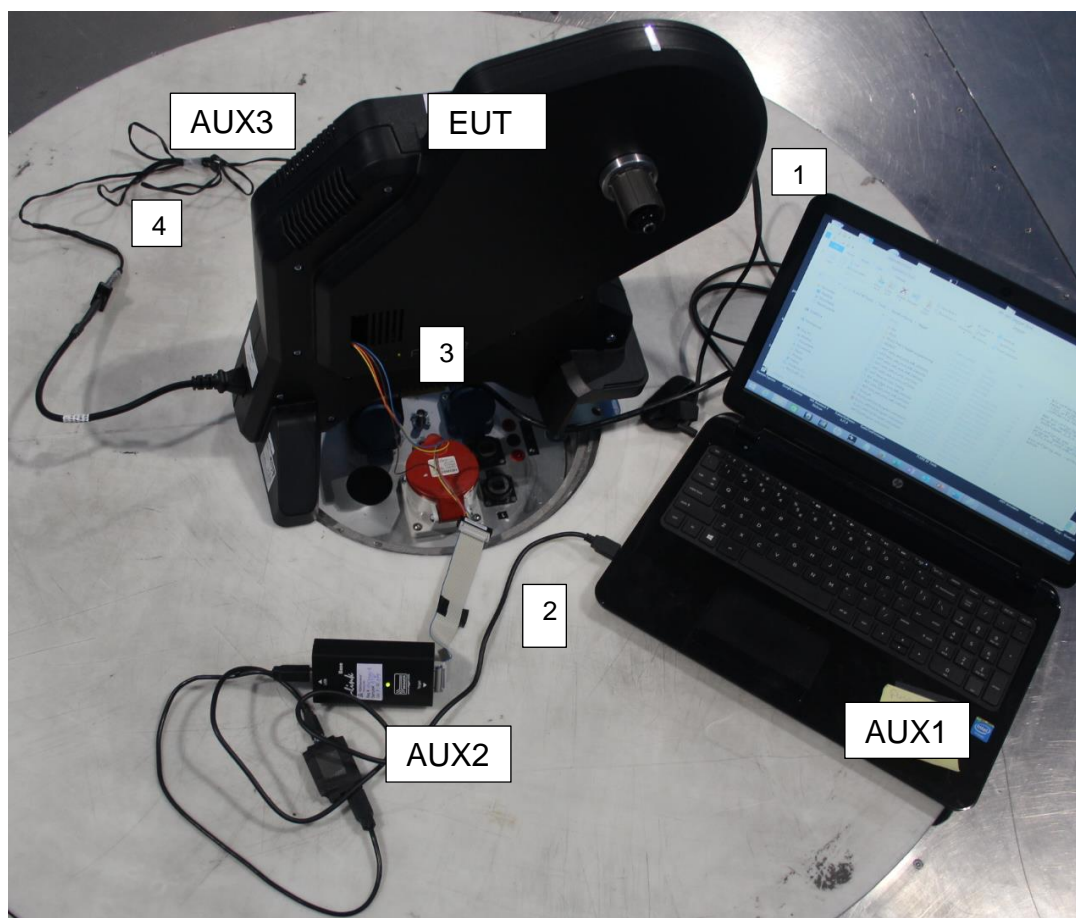

Figure 2: Test Setup Photos – radiated tests and programming

4.4 Test Software

A continuous transmit mode could be initiated by using test software as supplied by the applicant. The test software was used to define various different operational modes of the EUT for the purpose of compliance testing. The version of the test software, as supplied by the applicant and used during all tests is:

Test software : nRFTools 51422 v1.0.0

This software was running on a laptop computer (AUX1). It was used to enable the test operation modes listed in section 4.2 as appropriate.

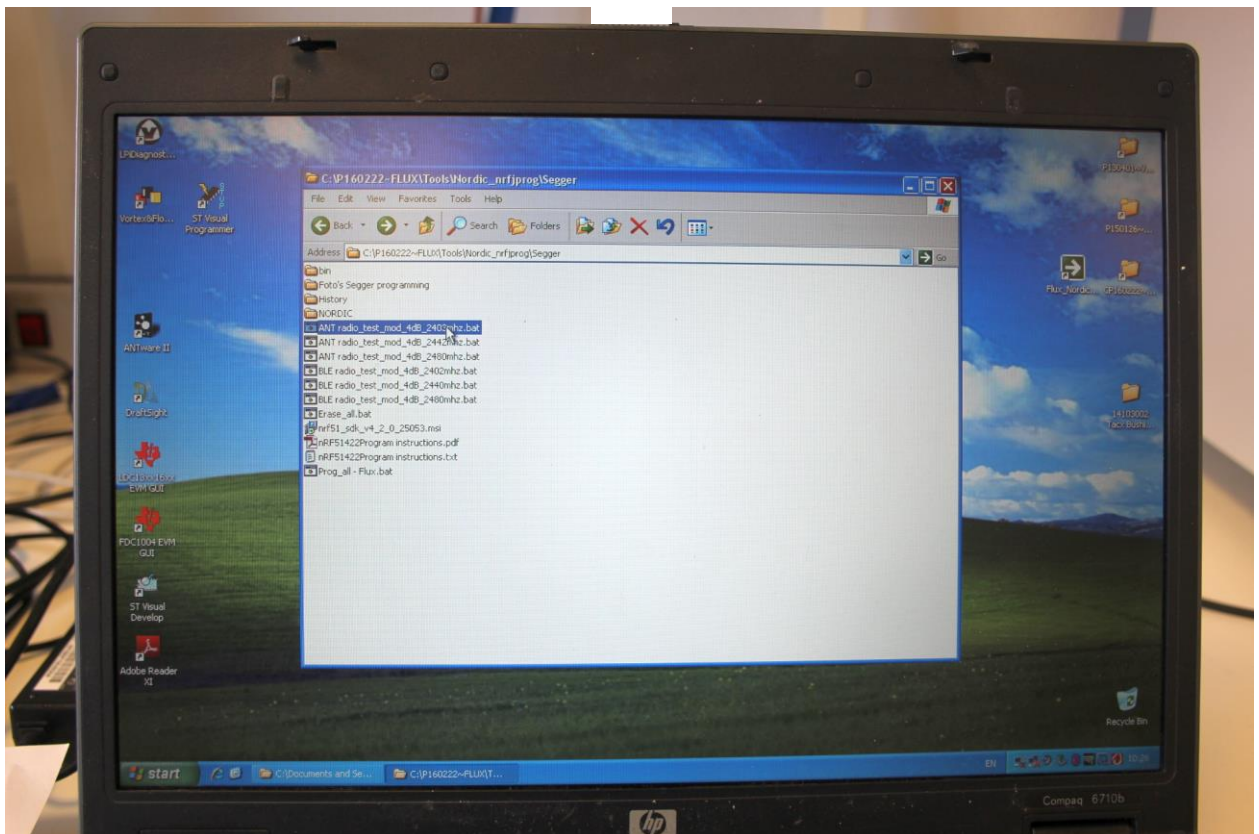

Screenshot of the software as used on AUX1

4.5 Special Accessories and Auxiliary Equipment

The product has been tested together with the following additional accessories:

The auxiliary items were not used during testing, but instead are only used to make the required settings for testing. For setting the transmit frequency, enable modulation etc.

1. AUX1

Product: Laptop Computer
Brand: HP
Model: J3T34EA#ABH
Serial Number: CND424BVDG
Remark: host for test software, property applicant



1. 2. AUX2

Product: Programming interface
Brand: Segger
Model: J-Link Base version 9.3
Serial Number: 59307055
Remark: property applicant



2. AUX3

Product: Power Supply Adapter
Brand: --
Model: FW 6299
Serial Number: 4197
Input voltage: 230 Vac 50 Hz
Output voltage: 40 Vac
Remark: property applicant



Test Report No.:

18052904A.r02

Page 14 of 36

5. Test Results

5.1.1 20dB and 99% Bandwidth

RESULT: Pass

Date of testing: 2019-05-07 & 10

Requirements:

For 99% Bandwidth: RSS-Gen Section 4.6.1: No requirement is given.

Test procedure 20dB bandwidth:

ANSI C63.10-2013

For 99% Bandwidth:

RSS-Gen.

The transmitter shall be operated at its maximum carrier power measured under normal test conditions. The span of the analyzer shall be set to capture all products of the modulation process, including the emission skirts. The resolution bandwidth shall be set as close to 1% of the selected span as is possible without being below 1%. The video bandwidth shall be set to 3 times the resolution bandwidth. Video averaging is not permitted. Where practical, a sampling detector shall be used given that a peak or peak hold may produce a wider bandwidth than actual.

A spectrum analyzer was connected to the antenna port of the EUT. The spectrum analyzer resolution bandwidth was set to 1% of the selected span, Video bandwidth was set to 3 times the resolution bandwidth. The span was set to capture the whole modulation process. The Spectrum analyzers automated function for 99% BW was used. Measurement uncertainty is +/- 26kHz.

Plots A1,B1 and C1 shown on the next pages are of the 20 dB bandwidth.
Plots A2,B2 and C2 shown on the next pages are of the 99% bandwidth

Test Report No.:

18052904A.r02

Page 15 of 36

Operating Frequency [MHz]	99% Bandwidth [kHz]	20 dB Bandwidth [kHz]	Plot number (99% / 20 dB)
2403	1682	1552	A1/A2
2440	1721	1639	B1/B2
2480	1661	1490	C1/C2

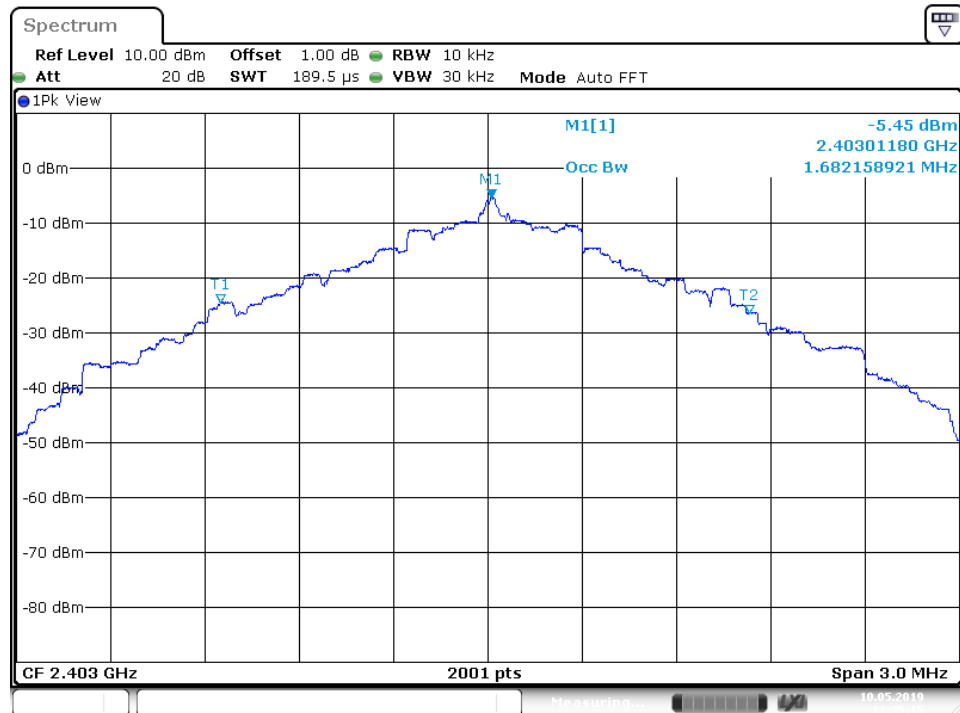

Date: 10 MAY 2019 13:25:15

Plot A1

Test Report No.:

18052904A.r02

Page 16 of 36

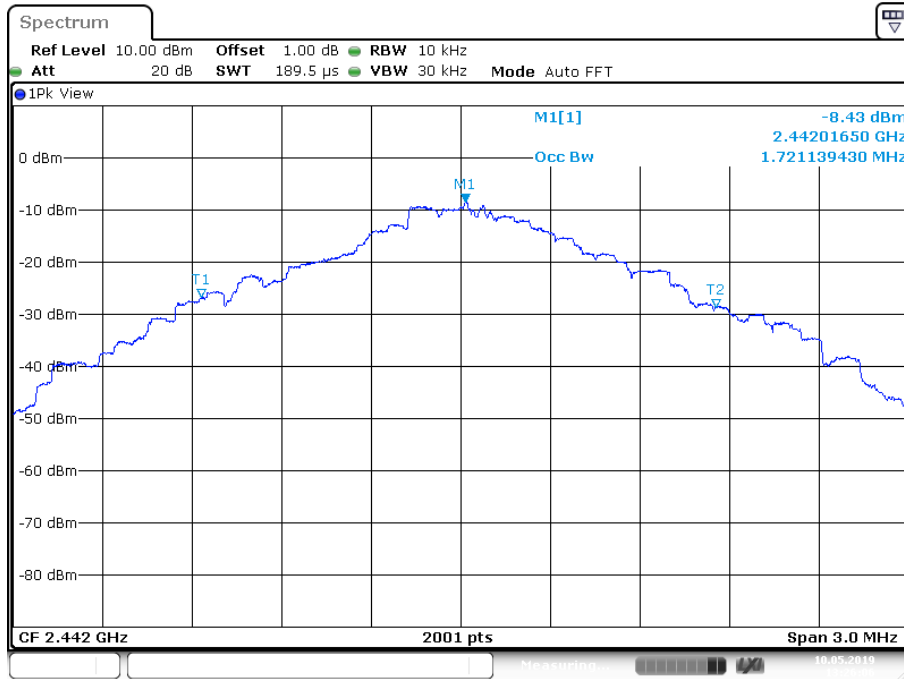

Plot B1

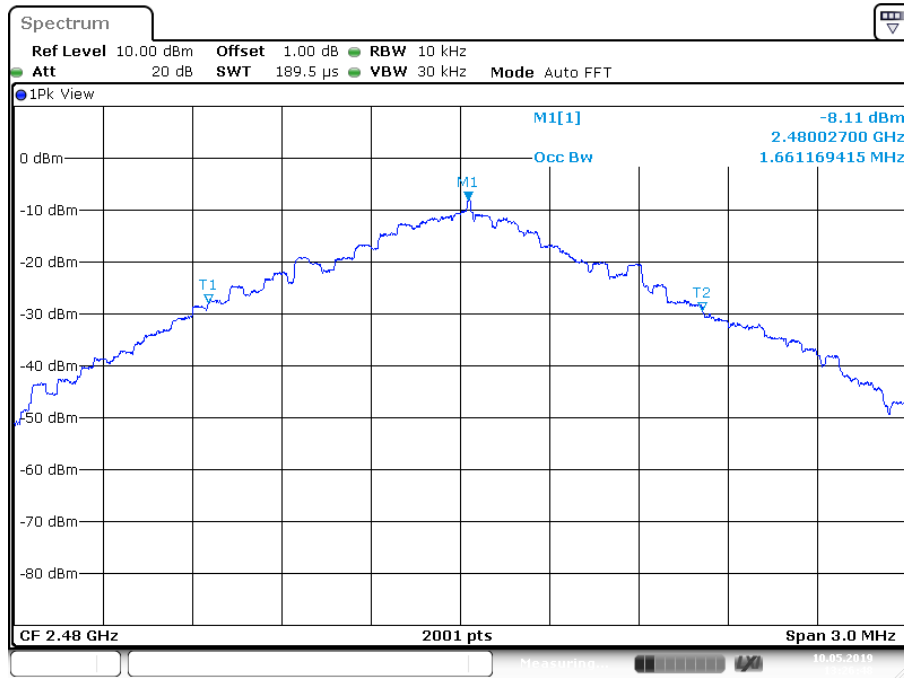

Plot C1

Test Report No.:

18052904A.r02

Page 17 of 36

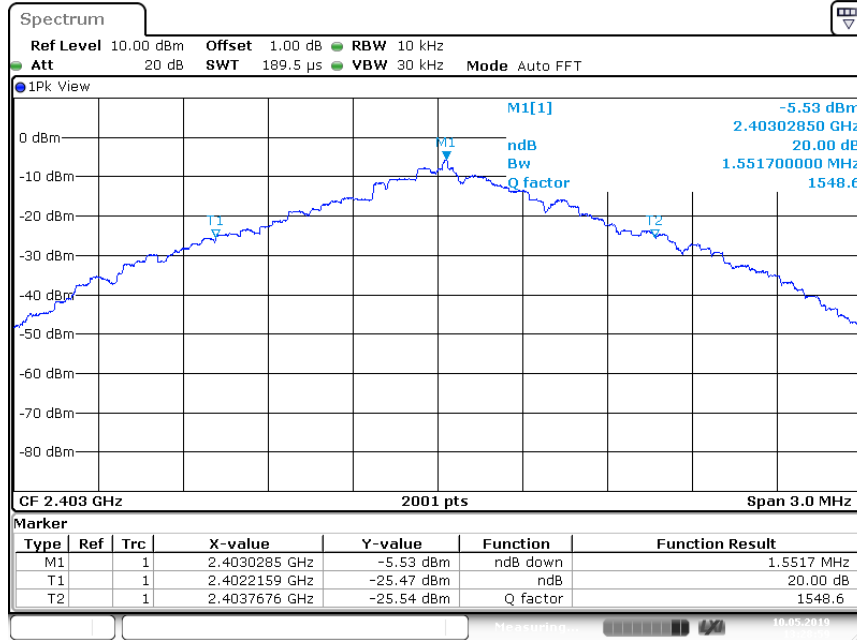

Date: 10 MAY 2019 13:28:59

Plot A2

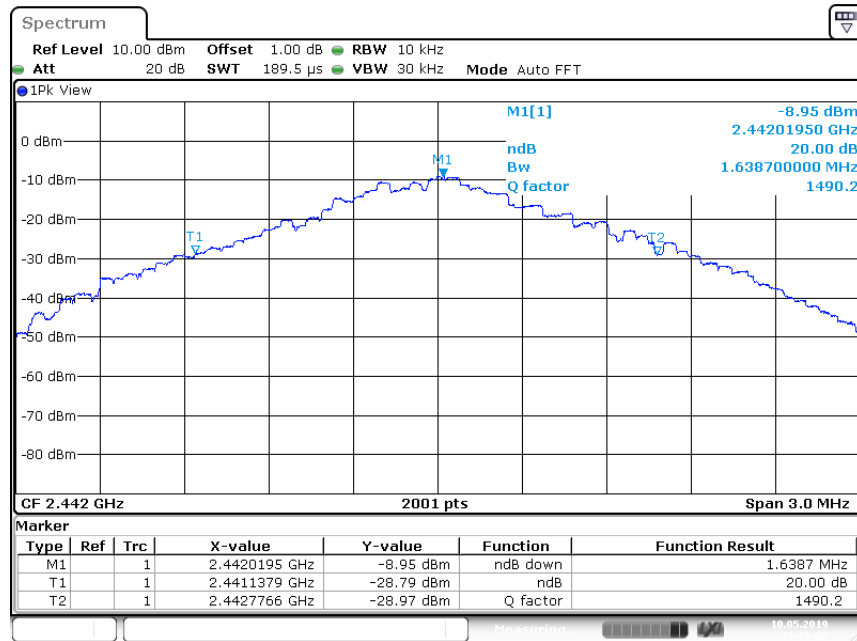

Date: 10 MAY 2019 13:28:21

Plot B2

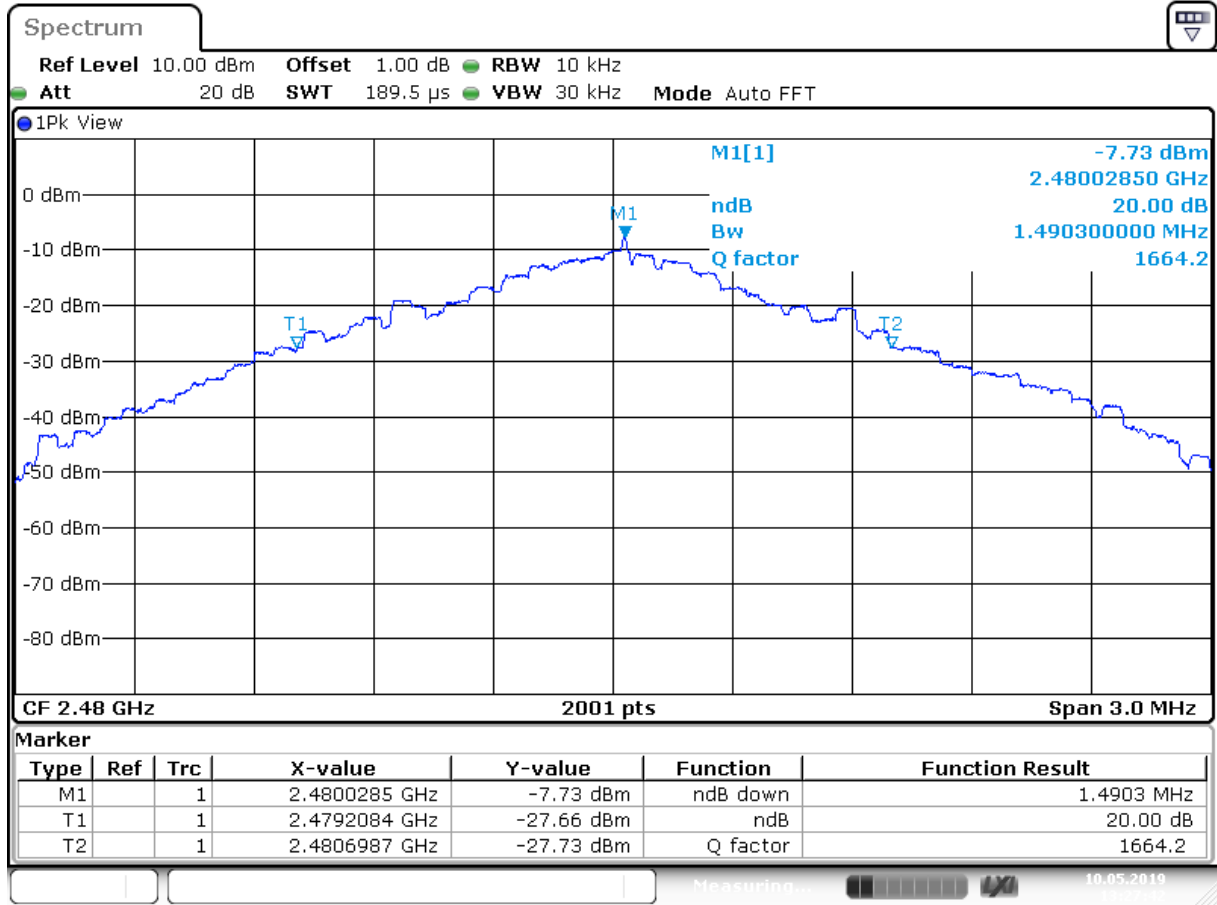

Date: 10 MAY 2019 13:27:42

Plot C2

Test Report No.:

18052904A.r02

Page 19 of 36

5.1.2 Radiated Spurious Emissions of Transmitter

RESULT: Pass

Date of testing: 2019-03-27 & 2019-04-10

Frequency range: 30MHz - 25GHz

Requirements:

FCC 15.209 and RSS-Gen

Radiated emissions which fall outside the operation frequency band and outside restricted bands shall either meet the limit specified in FCC 15.209(a) or be attenuated at least 50dB below the power level (the less severe limit applies).

Radiated emissions which fall in the restricted bands, as defined in FCC 15.205(a) and RSS-Gen Table 6, must comply with the radiated emission limits specified in FCC 15.209(a) and RSS-Gen Table 4.

Test procedure:

ANSI C63.10-2013

The EUT is regarded as floor standing equipment and was placed on the test site floor with an isolation plate of <12mm. Before final measurements of radiated emissions were performed, the EUT was scanned to determine its emission spectrum profile. The physical arrangement of the test system, the associated cabling were varied in order to ensure that maximum emission amplitudes were attained.

The spectrum was examined from 30MHz to the 10th harmonic of the highest fundamental transmitter frequency (25GHz). Final radiated emission measurements were made at 3m distance.

At each frequency where a spurious emission was found, the EUT was rotated 360° and the antenna was raised and lowered from 1 to 4m in order to determine the emission's maximum level. Measurements were taken using both horizontal and vertical antenna polarizations.

The highest emission amplitudes relative to the appropriate limit were recorded in this report. Field strength values of radiated emissions at frequencies not listed in the tables are more than 20 dB below the applicable limit. Where Peak (Pk) values were at least 6 dB under the Average (Av) limits, Av value was not tested. Where Average values were tested, Average values were measured using at least 10kHz Video Bandwidth.

Radiated Emissions, 30MHz - 1GHz

Frequency [MHz]	Antenna Orientation	Level QP [dBµV/m]	Limit QP [dBµV/m]	Verdict [Pass/Fail]
262.8	Vertical	20	46.0	Pass
489.7	Vertical	25	46.0	Pass
543.4	Vertical	30	46.0	Pass
557.4	Vertical	30	46.0	Pass
576.6	Vertical	33	46.0	Pass
800-960 noise	Vertical	32	46.0	Pass

- Notes:
- Level QP = Reading QP + Factor
 - Tested in modes as described in section 4.2, the 6 highest values noted. Preliminary measurements indicated that the radiated emissions from EUT were not affected by the EUT's operating mode or frequency.
 - Quasi Peak detector used with a bandwidth of 120 kHz.
 - Measurement uncertainty is +/- 5.22 dB.

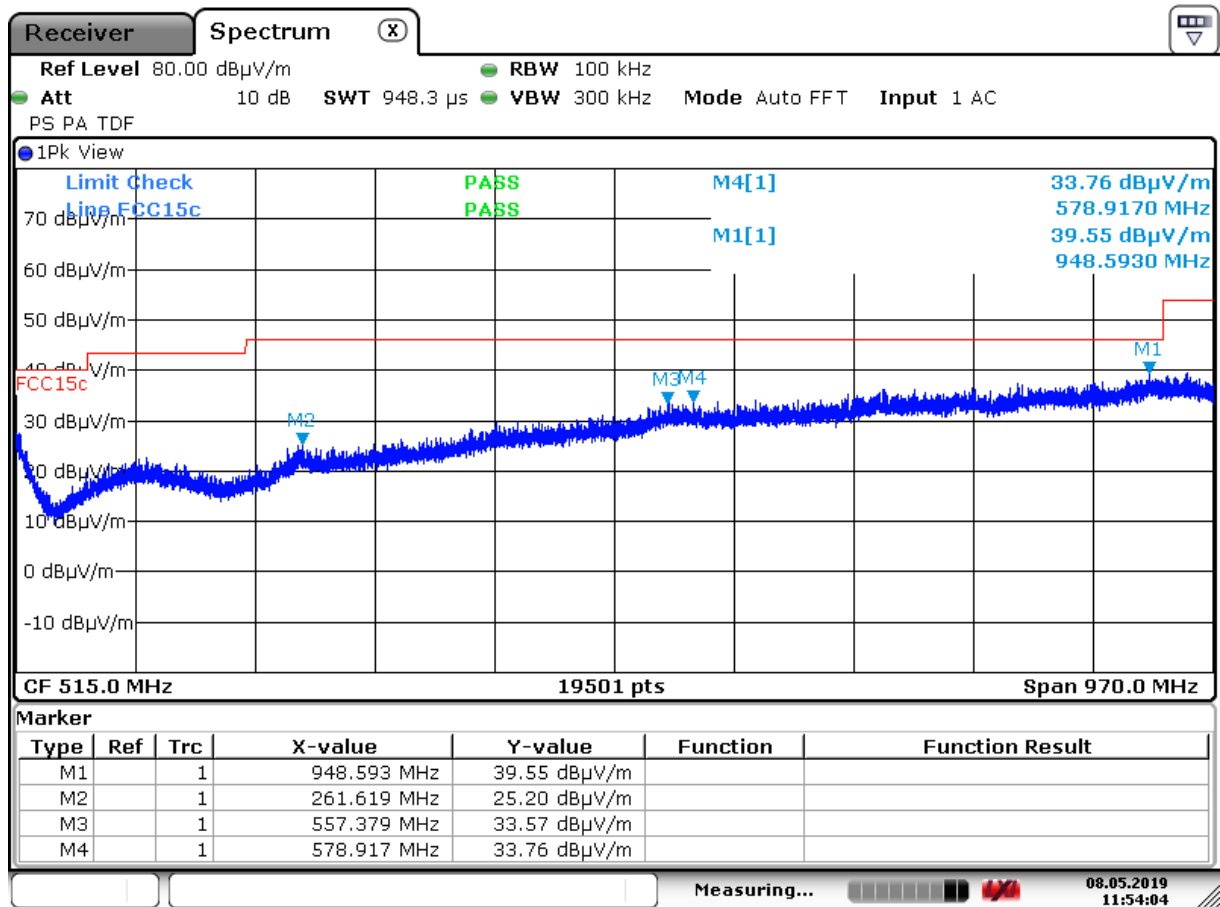

Date: 8.MAY.2019 11:54:04

Plot of the emissions @2442, Antenna vertical (Peak detector values shown)



Test Report No.:

18052904A.r02

Page 21 of 36

Radiated Emissions, 1 - 25GHz, 2403 MHz.

Frequency [MHz]	Antenna Orientation	Detector	Bandwidth (MHz)	Level [dBµV/m]	Limit [dBµV/m]	Result
2403 Fundamental	Vertical	Pk	1	94.0 Pk 91.5 Av	94 Av 114 Pk	Pass
1321 ^{*R}	Vertical	Pk	1	40.2	54 (Av) 74 (Pk)	Pass
1440 ^{*R}	Vertical	Pk	1	43.3	54 (Av) 74 (Pk)	Pass
2326 ^{*R}	Vertical	Pk	1	56.5 Pk 48.5 Av	54 (Av) 74 (Pk)	Pass
4806 ^{*H+R}	Vertical	Pk	1	51.2	54 (Av) 74 (Pk)	Pass
5999	Vertical	Pk	1	49.6	54 (Av) 74 (Pk)	Pass

Radiated Emissions, 1 - 25GHz, 2442 MHz.

Frequency [MHz]	Antenna Orientation	Detector	Bandwidth (MHz)	Level [dBµV/m]	Limit [dBµV/m]	Result
2442 fundamental	Horizontal	Pk	1	94.4 Pk 92.9 Av	94 (Av) 114 (Pk)	Pass
1440 ^{*R}	Horizontal	Pk	1	43.0	54 (Av) 74 (Pk)	Pass
2339 ^{*R}	Horizontal	Pk	1	42.0	54 (Av) 74 (Pk)	Pass
4883 ^{*H+R}	Horizontal	Pk	1	55.6 Pk 53.5 Av	54 (Av) 74 (Pk)	Pass
6163	Horizontal	Pk	1	50.5	54 (Av) 74 (Pk)	Pass

Test Report No.:

18052904A.r02

Page 22 of 36

Radiated Emissions, 1 - 25GHz, 2480 MHz.

Frequency [MHz]	Antenna Orientation	Detector	Bandwidth (MHz)	Level [dBµV/m]	Limit [dBµV/m]	Result
2480 fundamental	Horizontal	Pk	1	92.8 Pk	94 (Av) 114 (Pk)	Pass
1080 ^{*R}	Vertical	Pk	1	36.6	54 (Av) 74 (Pk)	Pass
1321 ^{*R}	Vertical	Pk	1	37.4	54 (Av) 74 (Pk)	Pass
1440 ^{*R}	Vertical	Pk	1	42.5	54 (Av) 74 (Pk)	Pass
4960 ^{*H} ^{*R}	Horizontal	Pk	1	54.6 Pk 53.0 Av	54 (Av) 74 (Pk)	Pass
7114	Horizontal	Pk	1	53.3	54 (Av) 74 (Pk)	Pass

- Notes:
- *R refers to a frequency in a restricted band,
 - *H refers to a frequency which is a harmonic of the fundamental.
 - Field strength values of radiated emissions not listed in the tables above are more than 20 dB below the applicable limit.
 - Measurement uncertainty is +/- 5.5 dB.
 - a selection of plots is provided on the next pages

Plots of the radiated emissions

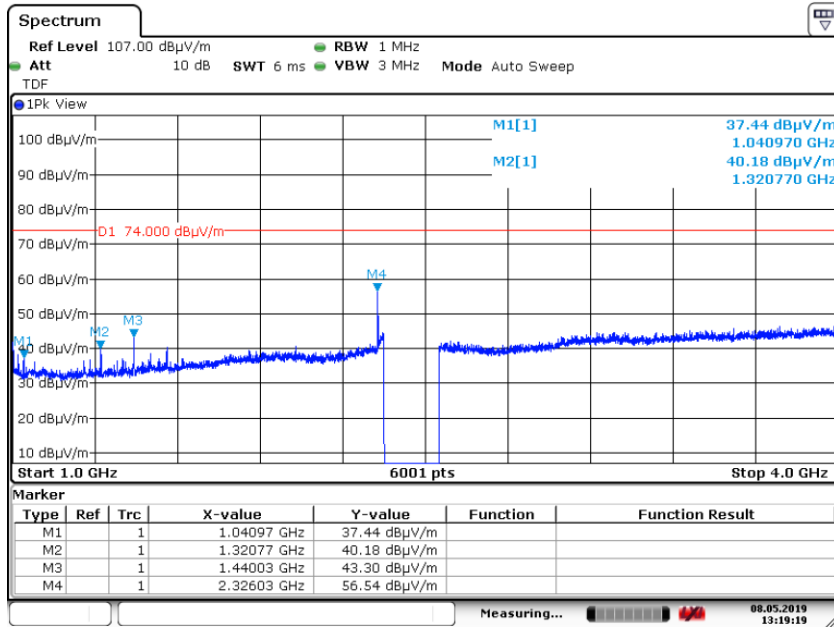

Date: 8.MAY.2019 13:19:19

Plot of the emissions at 2403 MHz in the range 1 – 4 GHz, Antenna Horizontal polarization, Peak values shown. (gap in the plot is of the used 2.4 GHz Notch filter).

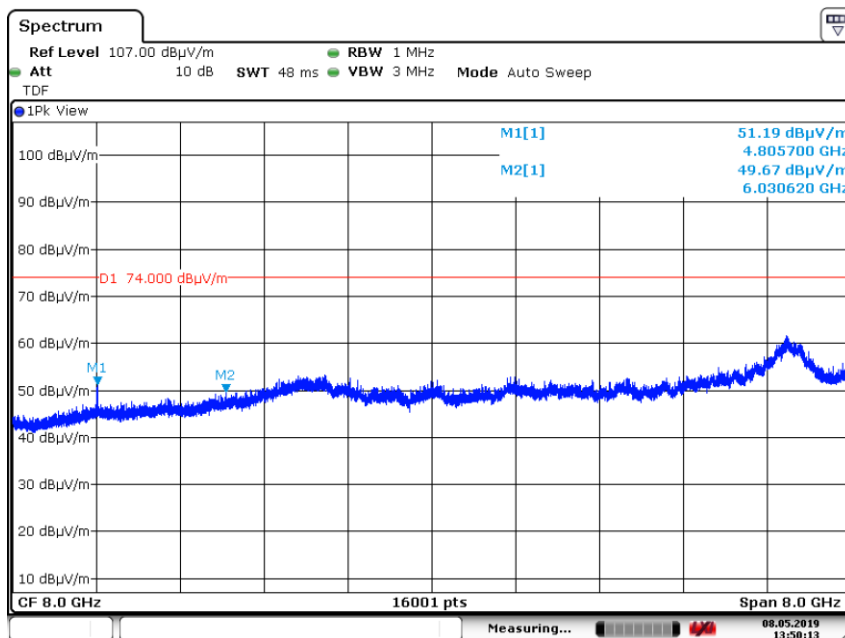

Date: 8.MAY.2019 13:50:13

Plot of the emissions at 2403 MHz in the range 4 – 12 GHz, Antenna Horizontal, Peak values shown

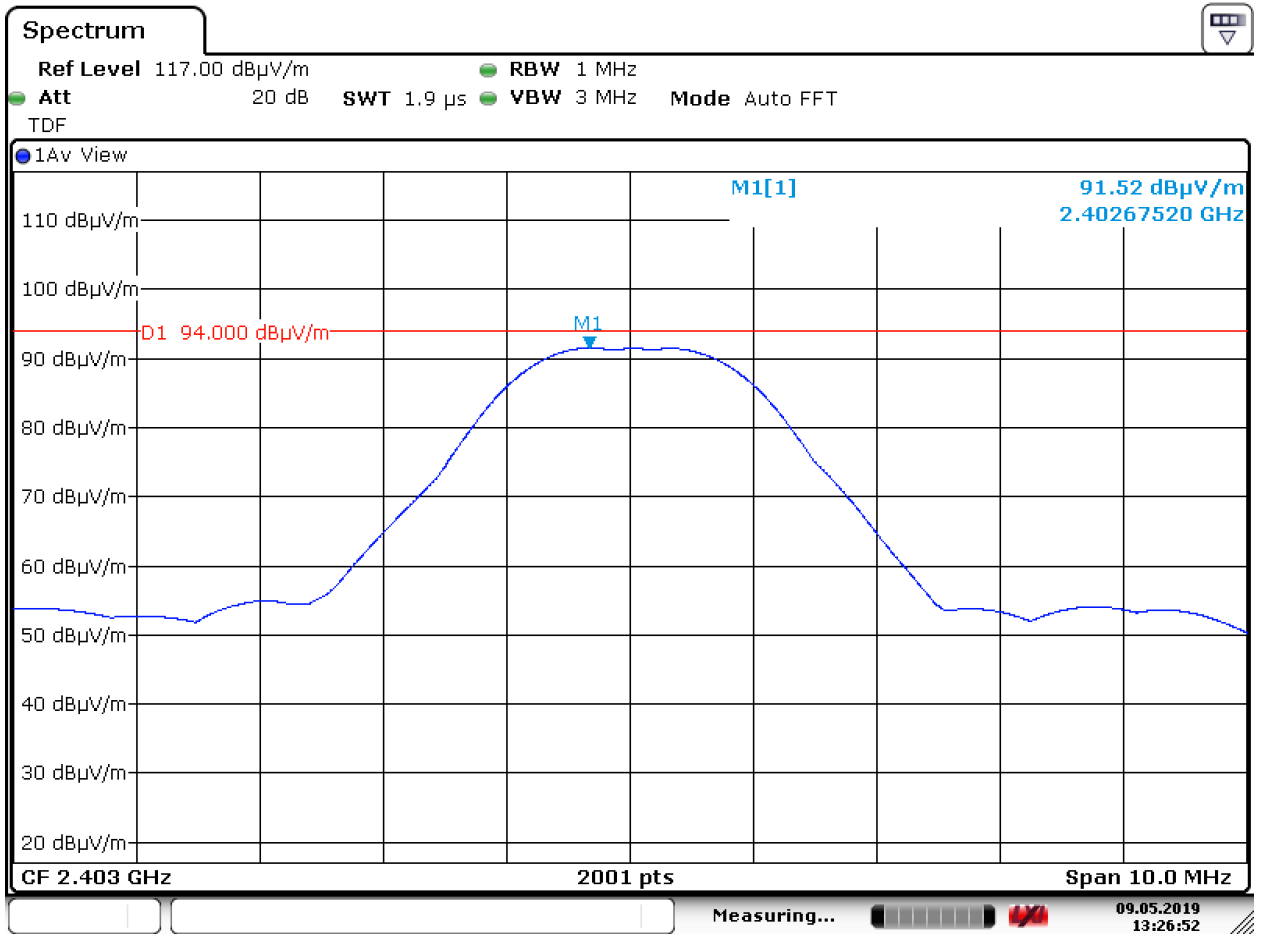

Date: 9.MAY.2019 13:26:52

Plot of the emissions at 2403 MHz, Vertical polarization, Average value of the fundamental

Test Report No.:

18052904A.r02

Page 25 of 36

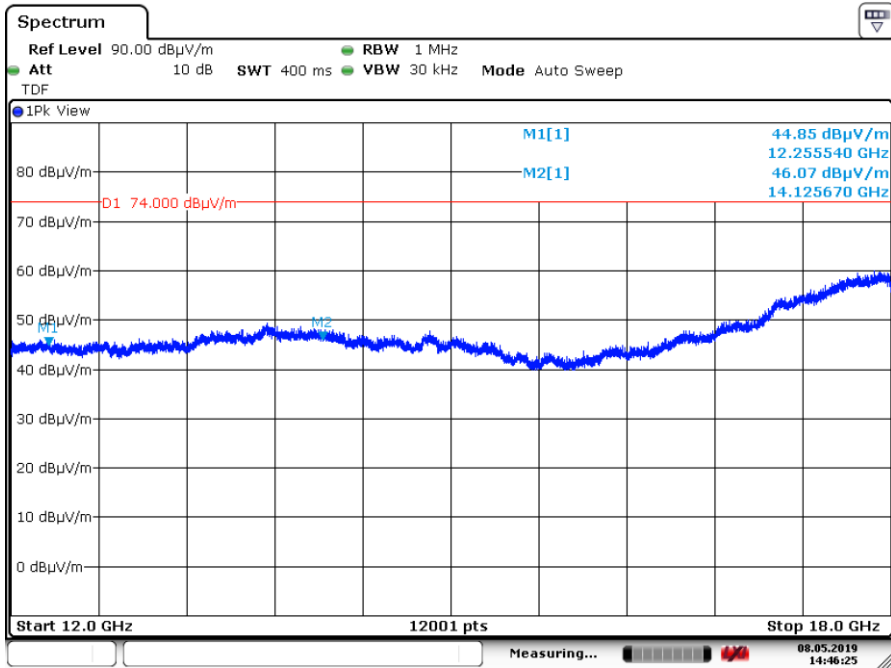

Date: 8.MAY.2019 14:46:26

Plot of the emissions at 2403 MHz in the range 12 – 18 GHz, Antenna Vertical, Peak values shown (Reduced Video Bandwidth used)

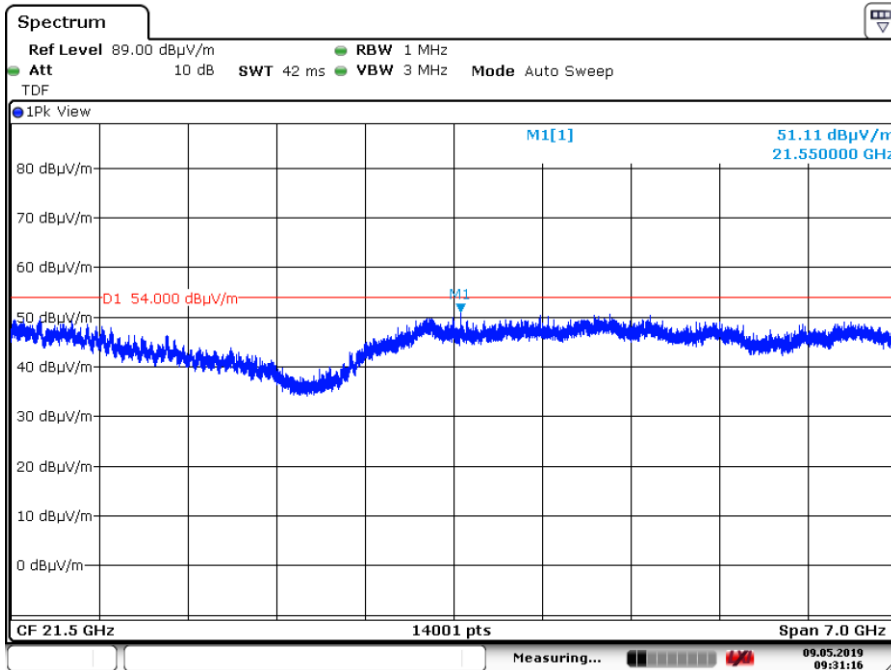

Date: 9.MAY.2019 09:31:16

Plot of the emissions at 2403 MHz in the range 18 – 25 GHz, Antenna Horizontal, Peak values shown

Test Report No.:

18052904A.r02

Page 26 of 36

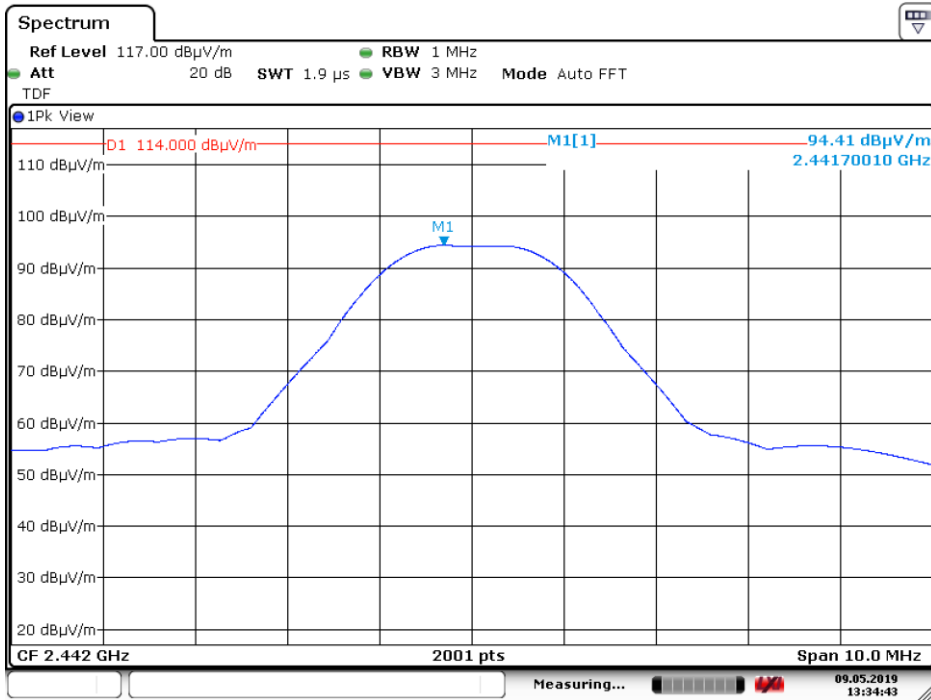

Date: 9.MAY.2019 13:34:43

Plot of the emissions at 2442 MHz, Vertical polarization, Peak value of the fundamental

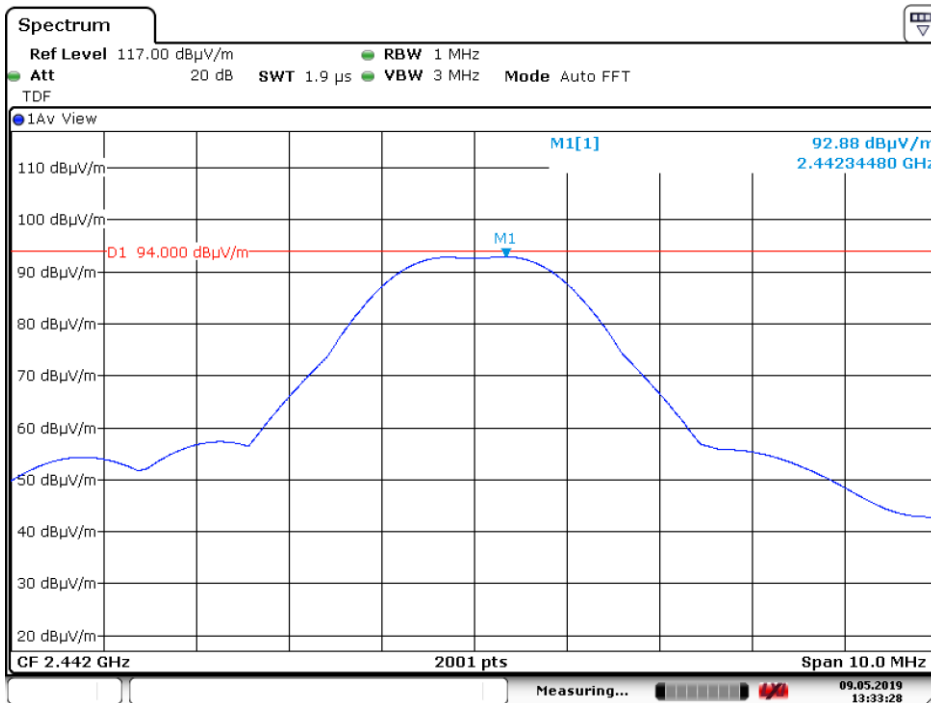

Date: 9.MAY.2019 13:33:28

Plot of the emissions at 2442 MHz, Vertical polarization, Average value of the fundamental

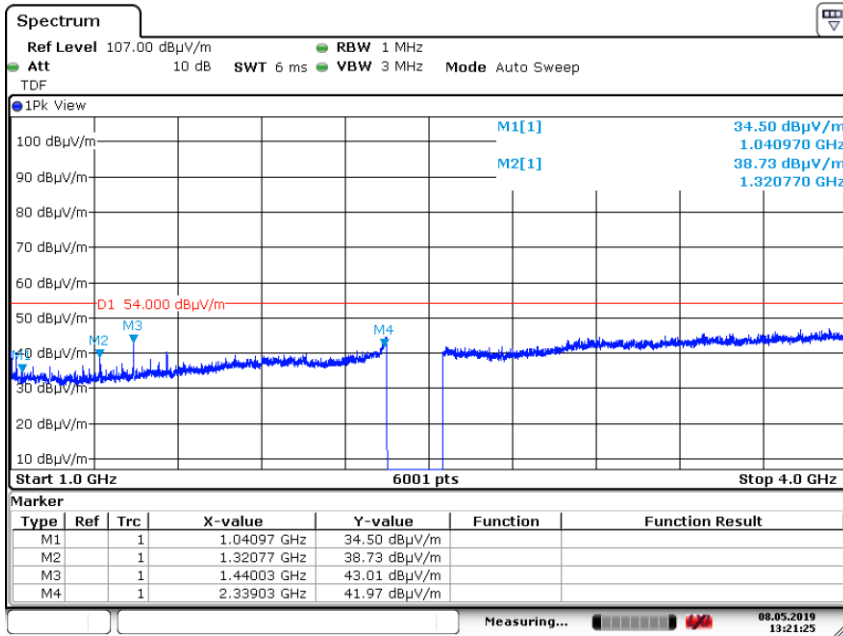

Date: 8.MAY.2019 13:21:25

Plot of the emissions at 2442 MHz in the range 1 – 4 GHz, horizontal polarization, Peak values shown. (gap in the plot is of the used 2.4 GHz Notch filter).

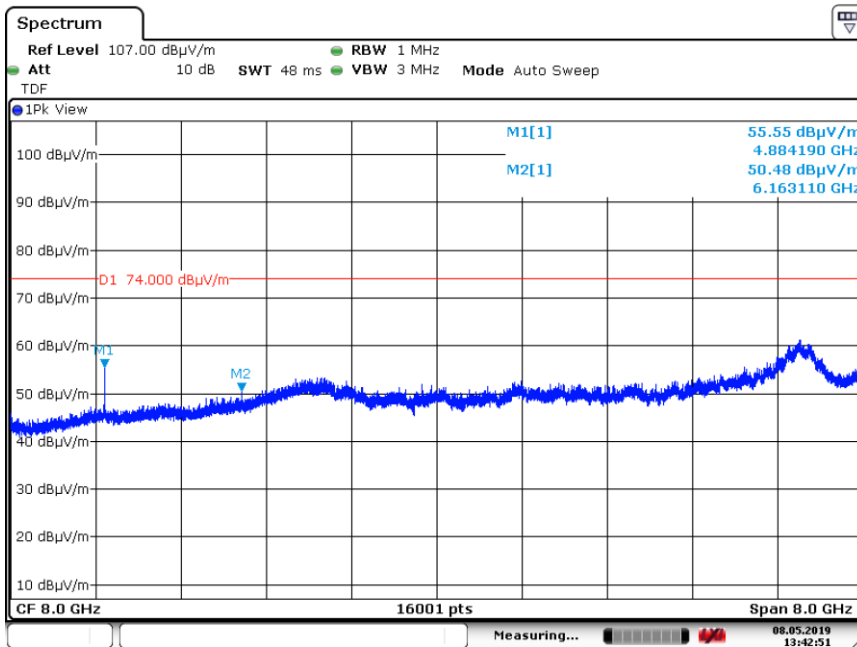

Date: 8.MAY.2019 13:42:51

Plot of the emissions at 2442 MHz in the range 4 – 12 GHz, Horizontal polarization, Peak values shown

Test Report No.:

18052904A.r02

Page 28 of 36

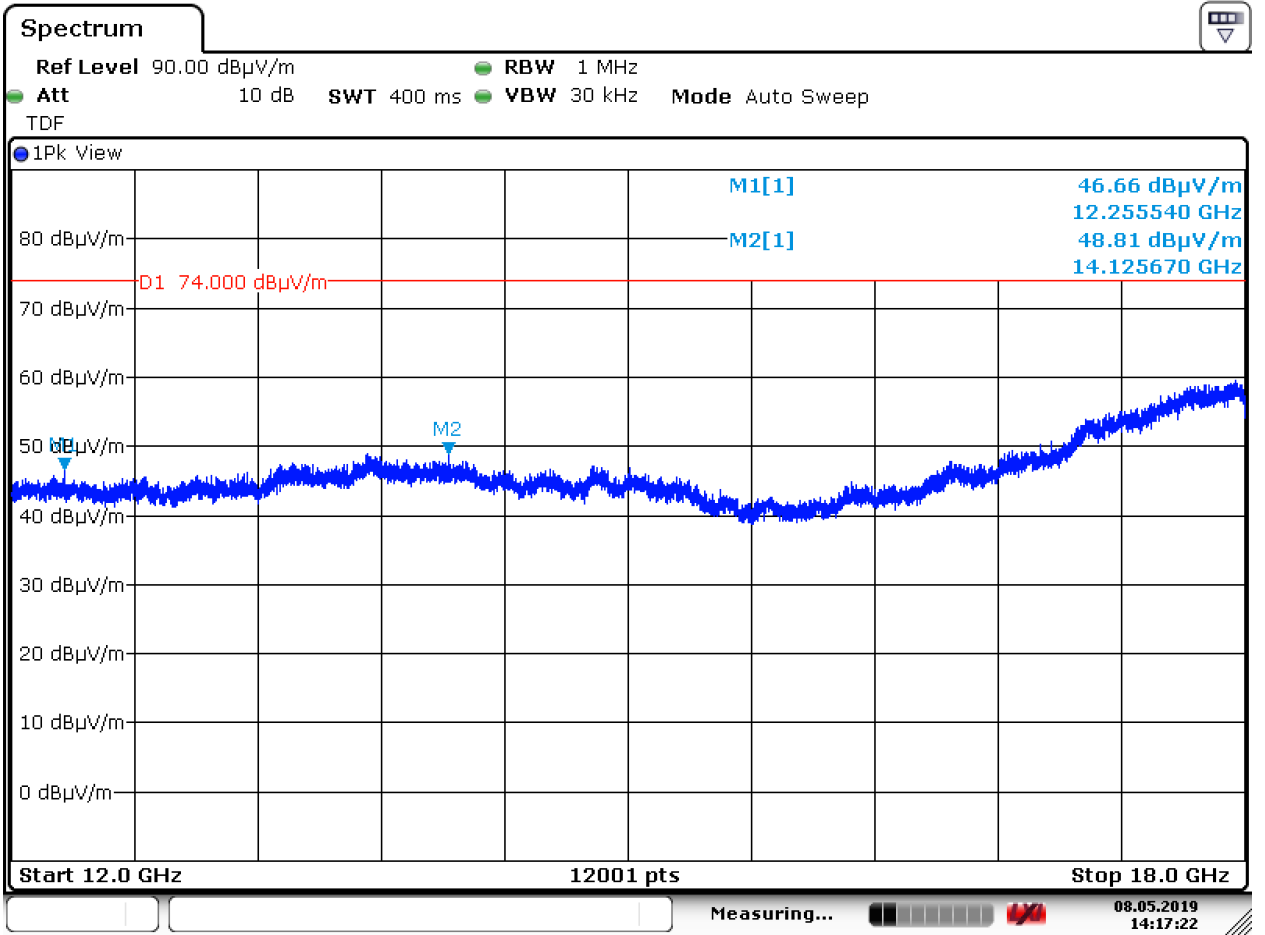

Date: 8.MAY.2019 14:17:22

Plot of the emissions at 2442 MHz in the range 12 – 18 GHz, Antenna Vertical, Peak values shown.
(Reduced Video Bandwidth used)

Test Report No.:

18052904A.r02

Page 29 of 36

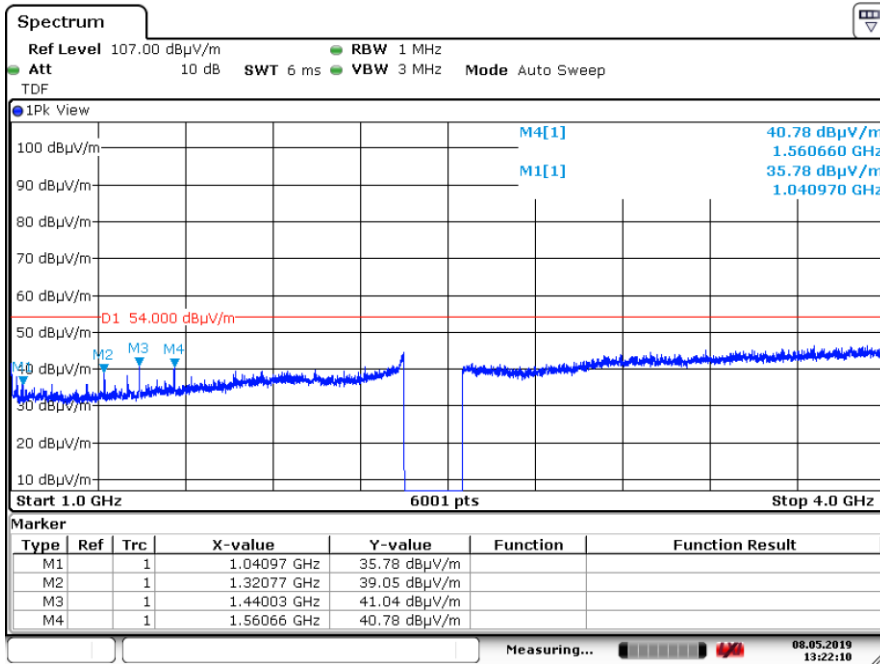

Date: 8.MAY.2019 13:22:10

Plot of the emissions at 2480 MHz in the range 1 – 4 GHz, Antenna horizontal polarization, Peak values shown. (gap in the plot is of the used 2.4 GHz Notch filter).

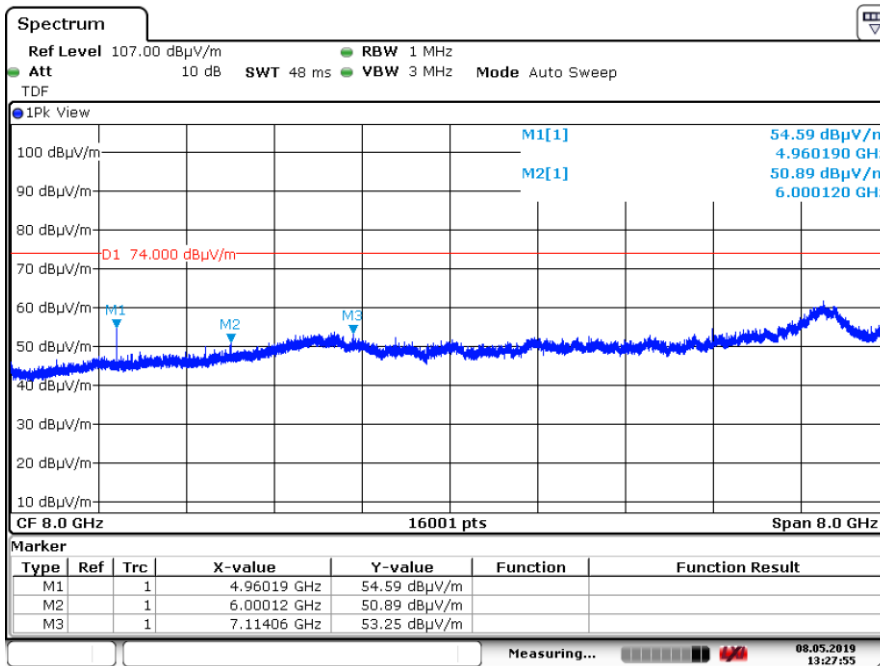

Date: 8.MAY.2019 13:27:55

Plot of the emissions at 2480 MHz in the range 4 – 12 GHz, Vertical polarization, Peak values shown

Test Report No.:

18052904A.r02

Page 30 of 36

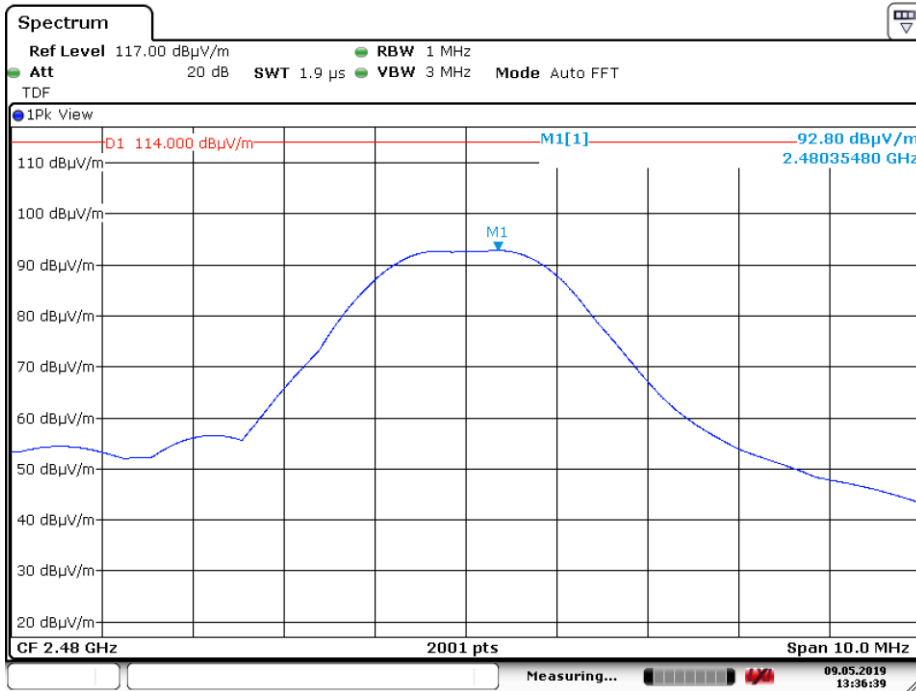

Date: 9.MAY.2019 13:36:39

Plot of the fundamental emission at 2480 MHz I, Antenna Vertical polarization, Peak value.

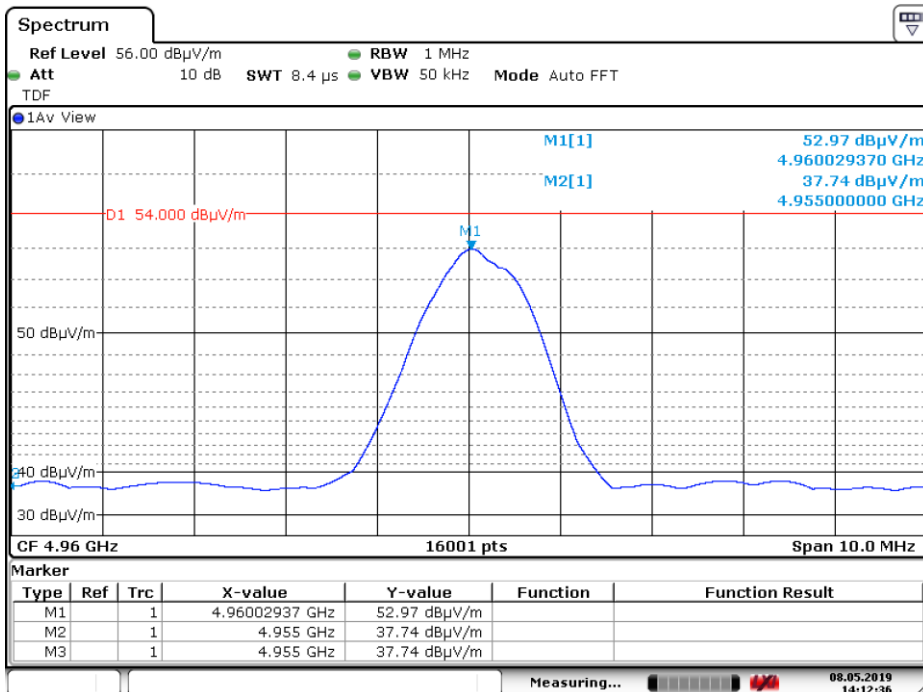

Date: 8.MAY.2019 14:12:36

Plot of the harmonic at 4960 MHz, Antenna Horizontal polarization, Average.

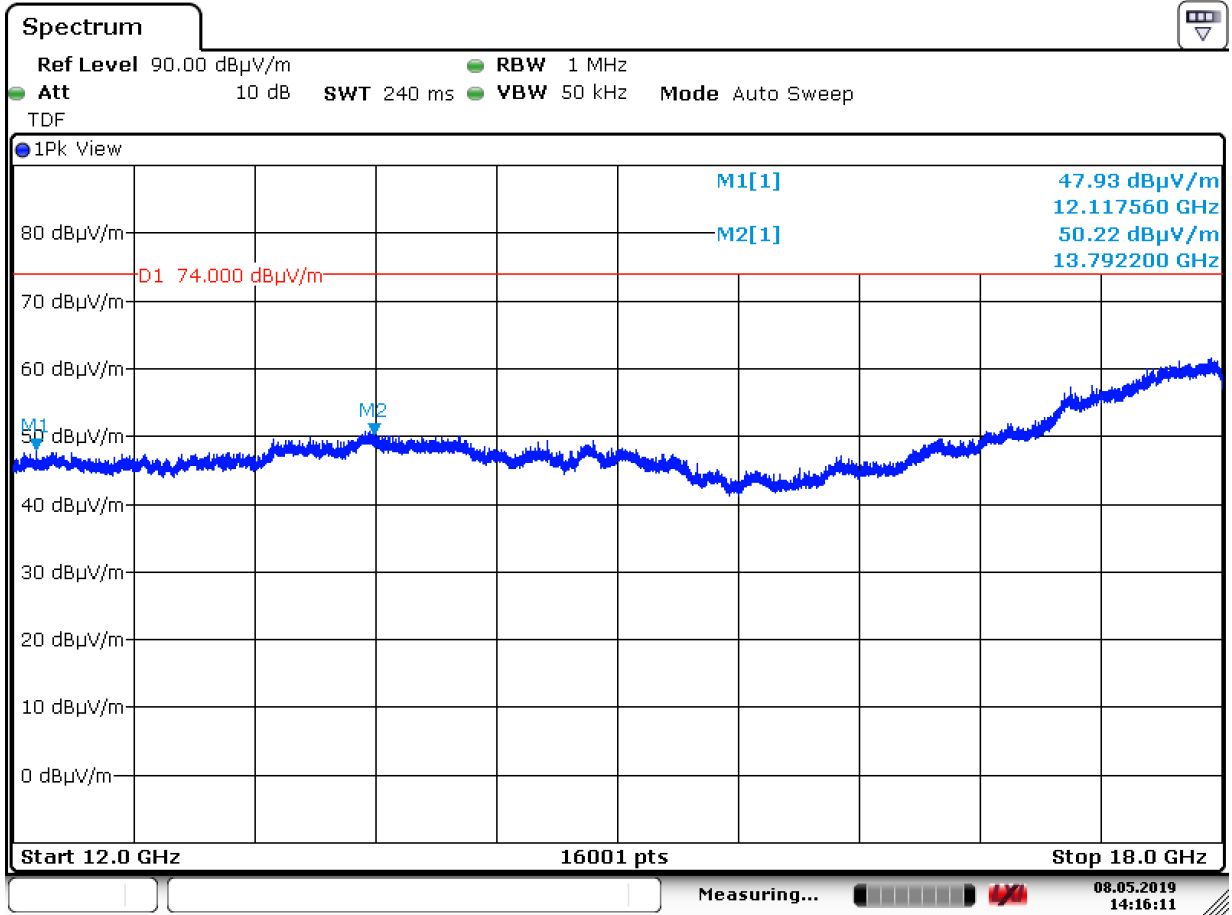

Date: 8.MAY.2019 14:16:11

Plot of the emissions at 2480 MHz in the range 12 – 18 GHz, EUT Vertical, Antenna vertical polarization, Peak values shown. (Reduced Video Bandwidth used)

5.2 AC Power Line Conducted Measurements

RESULT: Pass.

Date of testing: 2019-05-13

Requirements: for equipment that is designed to be connected to the public utility (AC) power line, the radio frequency voltage that is conducted back onto the AC power line on any frequency or frequencies within the band 150 kHz to 30 MHz shall not exceed the limits in the following table, as measured using a 50 μ H/50 ohms line impedance stabilization network (LISN). Compliance with the provisions of this paragraph shall be based on the measurement of the radio frequency voltage between each power line and ground at the power terminal. The lower limit applies at the band edges.

Frequency of Emission (MHz)	Conducted Limit (dB μ V) Quasi-Peak	Conducted Limit (dB μ V) Average
0.15 – 0.5	66 to 56*	56 to 46*
0.5 – 5	56	46
5 - 30	46	50

*Decreases with the logarithm of the frequency.

Test procedure:

ANSI C63.10-2013.

Each phase and neutral of the AC power line were measured with respect to ground. Measurements were performed using a 50 μ H / 50 Ω LISN. The frequency range from 150kHz to 30MHz was searched. The six highest EUT emissions relative to the limit were noted. The EUT is considered a floor-standing device. The EUT was positioned at least 80cm from the LISN. The power cable was routed over the non-conductive plate to the LISN. The system is regarded as floor standing equipment and an isolation plate of thickness <12mm is used.



Test Report No.:

18052904A.r02

Page 33 of 36

5.2.1 AC Power Line Conducted Emission of Transmitter

Frequency (MHz)	Measurement results (dBµV) L1		Measurement results (dBµV) L2/Neutral		Limits (dBµV)		Verdict (Pass/Fail)
	QP	AV	QP	AV	QP	AV	
0.1578	40.1	*3	40.7	*3	65.5	55.5	Pass
0.1734	36.3	*3	38.5	*3	65.0	55.0	Pass
0.2086	34.0	*3	32.5	*3	63.6	53.6	Pass
0.2398	31.1	*3	29.0	*3	62.1	52.1	Pass
0.2555	30.0	*3	25.0	*3	61.4	51.4	Pass
0.2906	26.0	*3	25.0	*3	60.5	50.5	Pass

The results of the AC power line conducted emission tests, carried out in accordance with 47 CFR Part 15 section 15.207(a) and RSS-Gen section 8.8, at the 120 Volts/ 60 Hz AC mains connection terminals of the EUT, are depicted in the table above.

Notes:

1. The resolution bandwidth used was 9 kHz.
2. Plots are provided on the next pages.
3. Qp values were already within Av limits, therefor Av not tested.
4. Tested on SN: 871950016

Test Report No.:

18052904A.r02

Page 34 of 36

5.2.2 Plots of the AC Power-line Conducted Emissions

13. May 19 14:38

Overview Scan Settings (1 Range)
 :----- Frequencies -----: Receiver Settings :-----:
 Start Stop Step IF BW Detector M-Time Atten Preamp
 150k 30M 3.9k 9k PK 0.10ms 20dB LN OFF

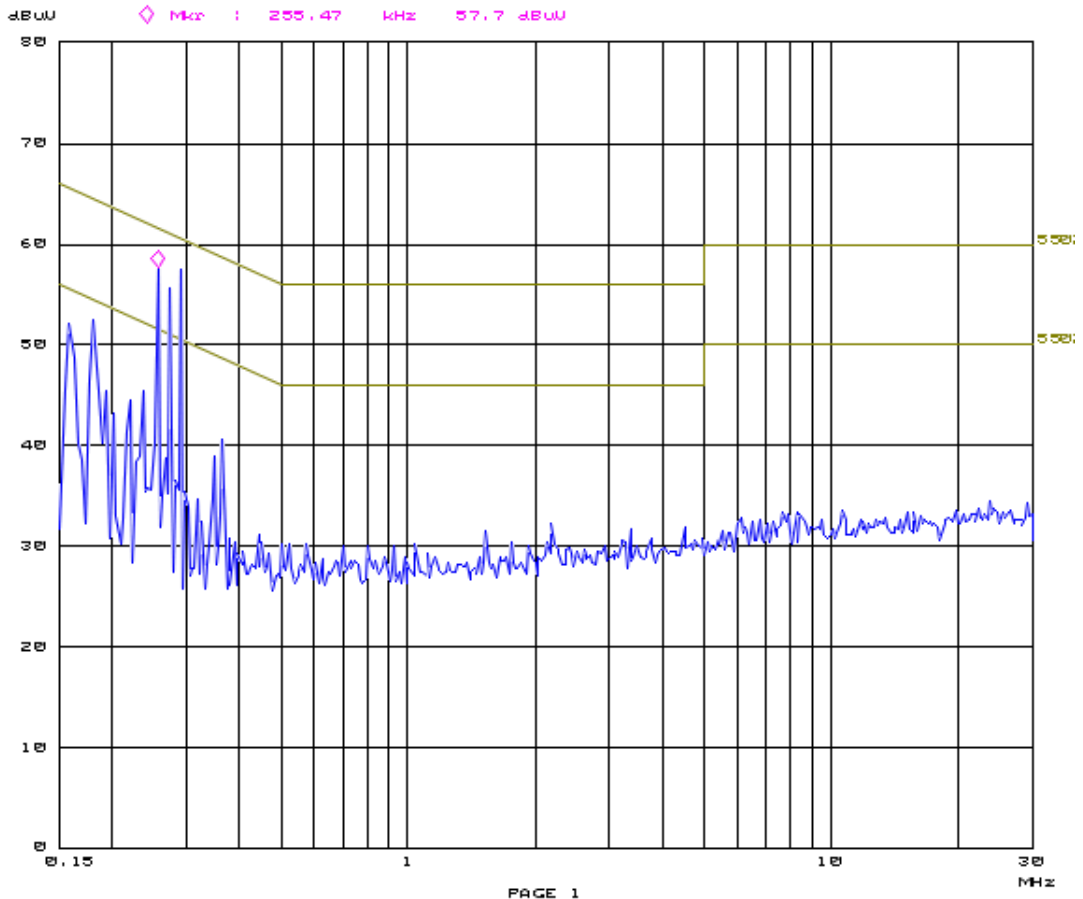

Plot of the AC Power-line Conducted emissions on L1

Test Report No.:

18052904A.r02

Page 35 of 36

13. May 19 14:22

Overview Scan Settings (1 Range)

Frequencies			Receiver Settings				
Start	Stop	Step	IF BW	Detector	M-Time	Atten	Preamp
150k	30M	3.9k	9k	PK	0.10ms	20dB LN	OFF

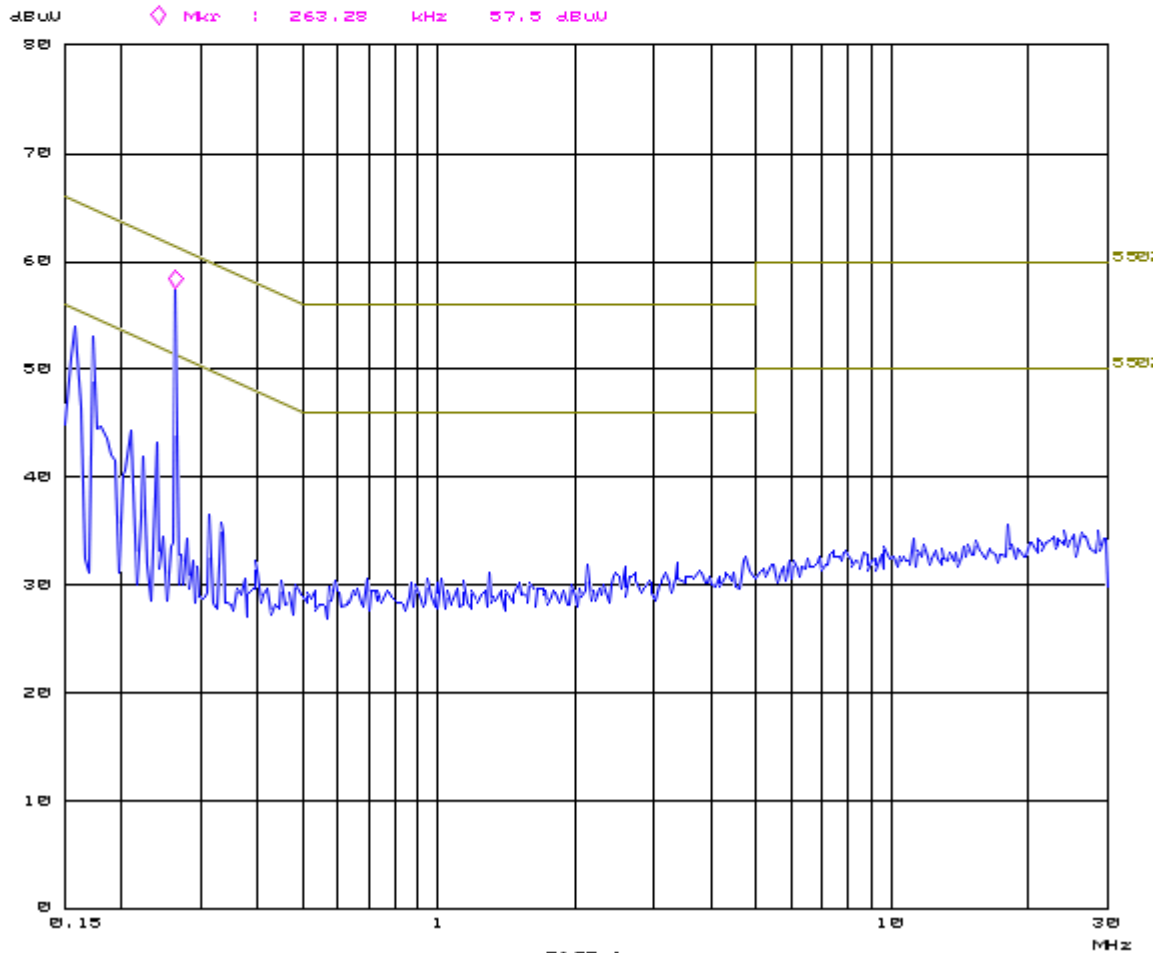

Plot of the AC Power-line Conducted emissions on N



Test Report No.:

18052904A.r02

Page 36 of 36

End of report