

**FCC PART 15 SUBPART B and C
TEST REPORT***for***NORDIC BLE MODULE****Model: SRD531**

Prepared for

BELWITH PRODUCTS, LLC
3100 BROADWAY AV SW
GRANDVILLE, MICHIGAN 49418

Prepared by: _____

KYLE FUJIMOTO

Approved by: _____

JAMES ROSS

COMPATIBLE ELECTRONICS INC.
114 OLINDA DRIVE
BREA, CALIFORNIA 92823
(714) 579-0500

DATE: JULY 14, 2013

	REPORT BODY	APPENDICES					TOTAL
		A	B	C	D	E	
PAGES	17	2	2	2	17	36	76

This report shall not be reproduced except in full, without the written approval of Compatible Electronics.

TABLE OF CONTENTS

Section / Title	PAGE
GENERAL REPORT SUMMARY	4
SUMMARY OF TEST RESULTS	4
1. PURPOSE	5
2. ADMINISTRATIVE DATA	6
2.1 Location of Testing	6
2.2 Traceability Statement	6
2.3 Cognizant Personnel	6
2.4 Date Test Sample was Received	6
2.5 Disposition of the Test Sample	6
2.6 Abbreviations and Acronyms	6
3. APPLICABLE DOCUMENTS	7
4. DESCRIPTION OF TEST CONFIGURATION	8
4.1 Description of Test Configuration – Emissions	8
4.1.1 Cable Construction and Termination	8
5. LISTS OF EUT, ACCESSORIES AND TEST EQUIPMENT	9
5.1 EUT and Accessory List	9
5.2 Emissions Test Equipment	10
6. TEST SITE DESCRIPTION	12
6.1 Test Facility Description	12
6.2 EUT Mounting, Bonding and Grounding	12
6.3 Facility Environmental Characteristics	12
7. TEST PROCEDURES	13
7.1 RF Emissions	13
7.1.1 Conducted Emissions Test	13
7.1.2 Radiated Emissions (Spurious and Harmonics) Test	14
7.1.3 Variation of the Input Power	15
7.1.4 RF Emissions Test Results	16
8. CONCLUSIONS	17

LIST OF APPENDICES

APPENDIX	TITLE
A	Laboratory Accreditations and Recognitions
B	Modifications to the EUT
C	Additional Models Covered Under This Report
D	Diagram, Charts, and Photos <ul style="list-style-type: none">• Test Setup Diagram• Antenna and Amplifier Factors• Radiated Emissions Photos
E	Data Sheets

LIST OF FIGURES

FIGURE	TITLE
1	Conducted Emissions Test Setup
2	Plot Map And Layout of the Radiated Test Site

GENERAL REPORT SUMMARY

Compatible Electronics Inc. generates this electromagnetic emission test report, which is an independent testing and consulting firm. The test report is based on testing performed by Compatible Electronics personnel according to the measurement procedures described in the test specifications given below and in the "Test Procedures" section of this report.

The measurement data and conclusions appearing herein relate only to the sample tested and this report may not be reproduced without the written permission of Compatible Electronics, unless done so in full.

This report must not be used to claim product endorsement by NVLAP, NIST or any other agency of the U.S. Government.

Device Tested: Nordic BLE Module
Model: SRD531
S/N: N/A

Product Description: See Expository Statement

Modifications: The EUT was not modified in order to meet the specifications.

Customer: Belwith Products, LLC
3100 Broadway AV SW
Grandville, Michigan 49418

Test Date(s): June 24, 25, and 27, 2013

Test Specifications: Emissions requirements
CFR Title 47, Part 15, Subpart B and Subpart C, Sections 15.205, 15.207, 15.209, and 15.249

Test Procedure: ANSI C63.4

Test Deviations: The test procedure was not deviated from during the testing.

SUMMARY OF TEST RESULTS

TEST	DESCRIPTION	RESULTS
1	Conducted RF Emissions 150 kHz to 30 MHz	Complies with the Class B limits of CFR Title 47, Part 15, Subpart B; and Subpart C, section 15.207.
2	Radiated RF Emissions 10 kHz to 25000 MHz (Transmitter and Digital Portion)	Complies with the Class B limits of CFR Title 47, Part 15, Subpart B; and Subpart C, sections 15.205, 15.209, and 15.249.

1. PURPOSE

This document is a qualification test report based on the emissions tests performed on the Nordic BLE Module, Model: SRD531 (EUT). The Emissions measurements were performed according to the measurement procedure described in ANSI C63.4. The tests were performed in order to determine whether the electromagnetic emissions from the equipment under test, referred to as EUT hereafter, are within the Class B specification limits defined by CFR Title 47, Part 15, Subpart B for the digital portion; and the limits defined in Subpart C, sections 15.205, 15.207, 15.209, and 15.249 for the transmitter portion.

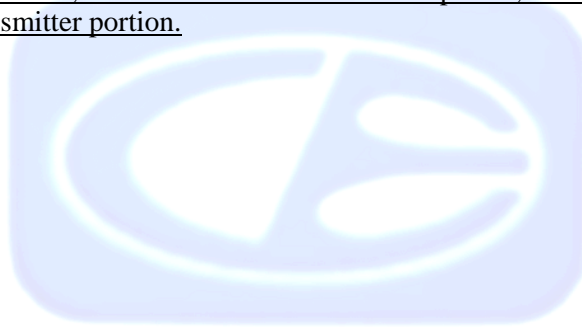

2. ADMINISTRATIVE DATA

2.1 Location of Testing

The Emissions tests described herein were performed at the test facility of Compatible Electronics, 114 Olinda Drive, Brea, California.

2.2 Traceability Statement

The calibration certificates of all test equipment used during the test are on file at the location of the test. The calibration is traceable to the National Institute of Standards and Technology (NIST).

2.3 Cognizant Personnel

Belwith Products, LLC

Thomas Guido General Manager and CFO

Compatible Electronics Inc.

Alex Benitez Test Technician

Kyle Fujimoto Test Engineer

James Ross Test Engineer

2.4 Date Test Sample was Received

The test sample was received on the initial test date of June 24, 2013.

2.5 Disposition of the Test Sample

The test sample has not been returned to Belwith Products, LLC as of the date of the test report.

2.6 Abbreviations and Acronyms

The following abbreviations and acronyms may be used in this document.

FCC	Federal Communications Commission
RF	Radio Frequency
EMI	Electromagnetic Interference
EUT	Equipment Under Test
P/N	Part Number
S/N	Serial Number
ITE	Information Technology Equipment
LISN	Line Impedance Stabilization Network
NVLAP	National Voluntary Laboratory Accreditation Program
CFR	Code of Federal Regulations
N/A	Not Applicable
Ltd.	Limited
Inc.	Incorporated
NCR	No Calibration Required

3. APPLICABLE DOCUMENTS

The following documents are referenced or used in the preparation of this Emissions Test Report.

SPEC	TITLE
CFR Title 47, Part 15	FCC Rules – Radio frequency devices (including digital devices)
ANSI C63.4: 2009	American National Standard for Methods of Measurement of Radio-Noise Emissions from Low-Voltage Electrical and Electronic Equipment in the Range of 9 kHz to 40 GHz

4. DESCRIPTION OF TEST CONFIGURATION

4.1 Description of Test Configuration – Emissions

The Nordic BLE Module, Model: SRD531 (EUT) was connected to a test board via 10-centimeter cables. The test board was also connected to a power supply via its power port. The EUT had a special test program that allowed the low, middle, or high channels, to be tested and to also select the data rate and bandwidth. The EUT was tested in three orthogonal axis.

It was determined that the emissions were at their highest level when the EUT was operating in the above configuration. The final emissions data was taken in this mode of operation and any cables were maximized. All initial investigations were performed with the measurement receiver in manual mode scanning the frequency range continuously. Photographs of the test setup are in Appendix D of this report.

4.1.1 Cable Construction and Termination

Cable 1 There is a 1-meter unshielded cable connecting the test board to the Universal AC/DC Adaptor. The cables are hard wired at each end.

Cables 2-28 These are 10-centimeter unshielded cables connecting the test board to the EUT. The cables are hard wired at each end.

5. LISTS OF EUT, ACCESSORIES AND TEST EQUIPMENT**5.1 EUT and Accessory List**

EQUIPMENT	MANUFACTURER	MODEL NUMBER	SERIAL NUMBER	FCC ID
NORDIC BLE MODULE (EUT)	BELWITH PRODUCTS, LLC	SRD531	N/A	2AAJWSRD531
UNIVERSAL AC/DC ADAPTOR	X1	PST-1200UF	N/A	N/A
TEST BOARD	N/A	N/A	N/A	N/A

5.2 Emissions Test Equipment

EQUIPMENT TYPE	MANUFACTURER	MODEL NUMBER	SERIAL NUMBER	CALIBRATION DATE	CALIBRATION CYCLE
GENERAL TEST EQUIPMENT USED IN LAB B					
Computer	Compaq	CQ5210F	CNX9360CF9	N/A	N/A
Monitor	Hewlett Packard	HPs2031a	3CQ046N3MD	N/A	N/A
EMI Receiver	Rohde & Schwarz	ESIB40	100194	November 19, 2012	2 Years
GENERAL TEST EQUIPMENT USED IN LAB A					
Computer	Hewlett Packard	p6716f	MXX1030PX0	N/A	N/A
Monitor	Hewlett Packard	HPs2031a	3CQ046N3MG	N/A	N/A
Spectrum Analyzer – Main Section	Hewlett Packard	8566B	2637A03618	May 6, 2013	1 Year
Spectrum Analyzer – Display Section	Hewlett Packard	85662A	2648A13404	May 6, 2013	1 Year
Quasi-Peak Adapter	Hewlett Packard	85650A	2811A01363	May 29, 2013	1 Year
RF RADIATED EMISSIONS TEST EQUIPMENT					
Combilog Antenna	Com Power	AC-220	61027	May 29, 2013	1 Year
Preamplifier	Com-Power	PA-103	1582	December 28, 2012	1 Year
Preamplifier	Com-Power	PA-118	181656	December 27, 2012	1 Year
Preamplifier	Com-Power	PA-840	711013	May 17, 2012	2 Year
Loop Antenna	Com-Power	AL-130	17089	January 29, 2013	2 Years
Horn Antenna	Com-Power	AH-118	071175	February 29, 2012	2 Years
Horn Antenna	Com-Power	AH-826	0071957	N/A	N/A
Antenna Mast	Com Power	AM-100	N/A	N/A	N/A
VARIATION OF THE INPUT POWER TEST EQUIPMENT					
Variable Auto Transformer	Staco Energy Products	3PN1010	N/A	N/A	N/A
Multimeter	Wavetek	DM25XT	40209875	May 30, 2012	2 Year

5.2 Emissions Test Equipment (Continued)

EQUIPMENT TYPE	MANUFACTURER	MODEL NUMBER	SERIAL NUMBER	CALIBRATION DATE	CALIBRATION CYCLE
CONDUCTED EMISSIONS TEST EQUIPMENT					
Emissions Program	Compatible Electronics	2.3 (SR19)	N/A	N/A	N/A
LISN	Com Power	LI-215	12082	June 17, 2013	1 Year
LISN	Com Power	LI-215	12090	June 17, 2013	1 Year
Transient Limiter	Seward	252A910	K39-0220	November 7, 2012	1 Year

6. TEST SITE DESCRIPTION**6.1 Test Facility Description**

Please refer to section 2.1 and 7.1.2 of this report for Emissions test location.

6.2 EUT Mounting, Bonding and Grounding

The EUT was mounted on a 1.0 by 1.5 meter non-conductive table 0.8 meters above the ground plane.

The EUT was not grounded.

6.3 Facility Environmental Characteristics

When applicable refer to the data sheets in Appendix E for the relative humidity, air temperature, and barometric pressure.

7. TEST PROCEDURES

The following sections describe the test methods and the specifications for the tests. Test results are also included in this section.

7.1 RF Emissions

7.1.1 Conducted Emissions Test

The measurement receiver was used as a measuring meter. The data was collected with the measurement receiver in the peak detect mode with the "Max Hold" feature activated. The quasi-peak was used only where indicated in the data sheets. A transient limiter was used for the protection of the measurement receiver's input stage, and the offset was adjusted accordingly to read the actual data measured. The LISN output was measured using the measurement receiver. The output of the second LISN was terminated by a 50-ohm termination. The effective measurement bandwidth used for this test was 9 kHz.

Please see section 6.2 of this report for mounting, bonding and grounding of the EUT. The EUT was powered through the LISN, which was bonded to the ground plane. The LISN power was filtered and the filter was bonded to the ground plane. The EUT was set up with the minimum distances from any conductive surfaces as specified in ANSI C63.4. The excess power cord was wrapped in a figure eight pattern to form a bundle not exceeding 0.4 meters in length.

The conducted emissions from the EUT were maximized for operating mode as well as cable placement. The final data was collected under program control by the Compatible Electronics conducted emissions software in several overlapping sweeps by running the spectrum analyzer at a minimum scan rate of 10 seconds per octave. The final qualification data is located in Appendix E.

Test Results:

The EUT complies with the **Class B** limits of CFR Title 47, Part 15, Subpart B; and the limits of CFR Title 47, Part 15, Subpart C, Sections 15.207.

7.1.2 Radiated Emissions (Spurious and Harmonics) Test

The spectrum analyzer, along with the quasi-peak adapter, and EMI Receiver were used as a measuring meter. Amplifiers were used to increase the sensitivity of the instrument. The Com-Power Preamplifier Model: PA-103 was used for frequencies from 30 MHz to 1 GHz, the Com-Power Microwave Preamplifier Model: PA-118 was used for frequencies from 1 GHz to 18 GHz, and the Com-Power Microwave Preamplifier Model: PA-840 were used for frequencies above 18 GHz. The spectrum analyzer and EMI Receiver were used in the peak detect mode with the "Max Hold" feature activated. In this mode, the spectrum analyzer and EMI receiver records the highest measured reading over the sweeps.

The quasi-peak function was used only for those readings which are marked accordingly on the data sheets.

The frequencies above 1 GHz were adjusted by a "duty cycle correction factor", derived from $20 \log(\text{dwell time} / \text{worst case } 100 \text{ ms period})$.

The measurement bandwidths and transducers used for the radiated emissions test were:

FREQUENCY RANGE	EFFECTIVE MEASUREMENT BANDWIDTH	TRANSDUCER
10 kHz to 150 kHz	200 Hz	Active Loop Antenna
150 kHz to 30 MHz	9 kHz	Active Loop Antenna
30 MHz to 1 GHz	120 kHz	Combilog Antenna
1 GHz to 25 GHz	1 MHz	Horn Antennas

The open field test site of Compatible Electronics, Inc. was used for radiated emission testing. This test site is set up according to ANSI C63.4. Please see section 6.2 of this report for mounting, bonding and grounding of the EUT. The turntable supporting the EUT is remote controlled using a motor. The turntable permits EUT rotation of 360 degrees in order to maximize emissions. Also, the antenna mast allows height variation of the antenna from 1 meter to 4 meters. Data was collected in the worst case (highest emission) configuration of the EUT by the Radiated Emission Manual Test software. At each reading, the EUT was rotated 360 degrees and the antenna height was varied from 1 to 4 meters (for E field radiated field strength). The gun sight method was used when measuring with the horn antenna in order to ensure accurate results. The loop antenna was also rotated in the vertical axis in order to ensure accurate results.

Radiated Emissions (Spurious and Harmonics) Test (continued)

The presence of ambient signals was verified by turning the EUT off. In case an ambient signal was detected, the measurement bandwidth was reduced temporarily and verification was made that an additional adjacent peak did not exist. This ensures that the ambient signal does not hide any emissions from the EUT. The EUT was tested at a 3-meter test distance from 30 MHz to 25 GHz and at a 10-meter distance from 10 kHz to 30 MHz to obtain the final test data.

Test Results:

The EUT complies with the **Class B** limits of CFR Title 47, Part 15, Subpart B; and the limits of CFR Title 47, Part 15, Subpart C, Sections 15.209 and 15.249.

7.1.3 Variation of the Input Power

The variation of the input power test was performed using the EMI Receiver. The EUT input power was varied between 85% and 115% of the nominal rated supply voltage. The carrier frequency was monitored for any change in amplitude.

Test Results:

The EUT complies with the relevant requirements of FCC Title 47, Part 15, Subpart C section 15.31(e).

7.1.4 RF Emissions Test Results

Table 1.0 CONDUCTED EMISSION RESULTS
 Nordic BLE Module, Model: SRD531

Frequency MHz	Emission Level* dBuV	Average Specification Limit dBuV	Delta (Emission – Spec. Limit) dB
2.100 (WL)	43.04	46.00	-2.96
1.338 (BL)	42.74	46.00	-3.26
0.324 (BL)	46.28	49.62	-3.33
2.322 (BL)	42.55	46.00	-3.45
2.089 (BL)	42.55	46.00	-3.45
1.397 (BL)	42.44	46.00	-3.56

Table 2.0 RADIATED EMISSION RESULTS
 Nordic BLE Module, Model: SRD531

Frequency MHz	Corrected Reading* dBuV	Specification Limit dBuV	Delta (Cor. Reading – Spec. Limit) dB
2400 (H)	45.54 (A)	54.00	-8.46
2400 (V)	45.15 (A)	54.00	-8.85
2392.91 (V)	40.98 (A)	54.00	-13.02
2485.37 (H)	40.35 (A)	54.00	-13.65
2392.70 (H)	40.33 (A)	54.00	-13.67
2485.4 (V)	39.15 (A)	54.00	-14.85

Notes:

- * The complete emissions data is given in Appendix E of this report.
- (BL) BLACK LEAD
- (WL) WHITE LEAD
- (V) VERTICAL
- (H) HORIZONTAL
- (A) AVERAGE

8. CONCLUSIONS

The Nordic BLE Module, Model: SRD531 (EUT), as tested, meets all of the **Class B** specification limits defined in CFR Title 47, Part 15, Subpart B for the digital portion; and the limits defined in Subpart C, sections 15.205, 15.207, 15.209, and 15.249 for the transmitter portion.



APPENDIX A***LABORATORY ACCREDITATIONS AND RECOGNITIONS***

Brea Division
114 Olinda Drive
Brea, CA 92823
(714) 579-0500

Agoura Division
2337 Troutdale Drive
Agoura, CA 91301
(818) 597-0600

Silverado Division
19121 El Toro Road
Silverado, CA 92676
(949) 589-0700

Lake Forest Division
20621 Pascal Way
Lake Forest, CA 92630
(949) 587-0400

LABORATORY ACCREDITATIONS AND RECOGNITIONS



NVLAP LAB CODES 200063-0,
200528-0, 200527-0

For US, Canada, Australia/New Zealand, Japan, Taiwan, Korea, and the European Union, Compatible Electronics is currently accredited by NVLAP to ISO/IEC 17025. Please follow the link to the NIST/NVLAP site for each of our facilities' NVLAP certificate and scope of accreditation

NVLAP listing links

[Agoura Division](#) / [Brea Division](#) / [Silverado/Lake Forest Division](#)

.Quote from ISO-ILAC-IAF Communiqué on 17025:

"A laboratory's fulfillment of the requirements of ISO/IEC 17025:2005 means the laboratory meets both the technical competence requirements and management system requirements that are necessary for it to consistently deliver technically valid test results and calibrations. The management system requirements in ISO/IEC 17025:2005 (Section 4) are written in language relevant to laboratory operations and meet the principles of ISO 9001:2008 Quality Management Systems — Requirements."



ANSI listing [CETCB](#)



Compatible Electronics has been nominated as a Conformity Assessment Body (CAB) for EMC under the US/EU Mutual Recognition Agreement (MRA).

US/EU MRA list [NIST MRA site](#)



Compatible Electronics has been nominated as a Conformity Assessment Body (CAB) for Taiwan/BSMI under the US/APEC (Asia-Pacific Economic Cooperation) Mutual Recognition Agreement (MRA).

APEC MRA list [NIST MRA site](#)

We are also listed for IT products by the following country/agency:



VCCI Support member: Please visit http://www.vcci.jp/vcci_e/



FCC Listing, from FCC OET site

[FCC test lab search](https://fjallfoss.fcc.gov/oetcf/eas/reports/TestFirmSearch.cfm) <https://fjallfoss.fcc.gov/oetcf/eas/reports/TestFirmSearch.cfm>



Compatible Electronics IC listing can be found at:

<http://www.ic.gc.ca/eic/site/ic1.nsf/eng/home>

APPENDIX B

MODIFICATIONS TO THE EUT

MODIFICATIONS TO THE EUT

The modifications listed below were made to the EUT to pass FCC 15.207, FCC 15.249 and/or FCC **Class B** specifications.

All the rework described below was implemented during the test in a method that could be reproduced in all the units by the manufacturer.

No modifications were made to the EUT during the testing.



APPENDIX C

***ADDITIONAL MODELS COVERED
UNDER THIS REPORT***

ADDITIONAL MODELS COVERED UNDER THIS REPORT

USED FOR THE PRIMARY TEST

Nordic BLE Module
Model: SRD531
S/N: N/A

No additional model numbers are approved under this report.



APPENDIX D

DIAGRAMS, CHARTS, AND PHOTOS

FIGURE 1: CONDUCTED EMISSIONS TEST SETUP

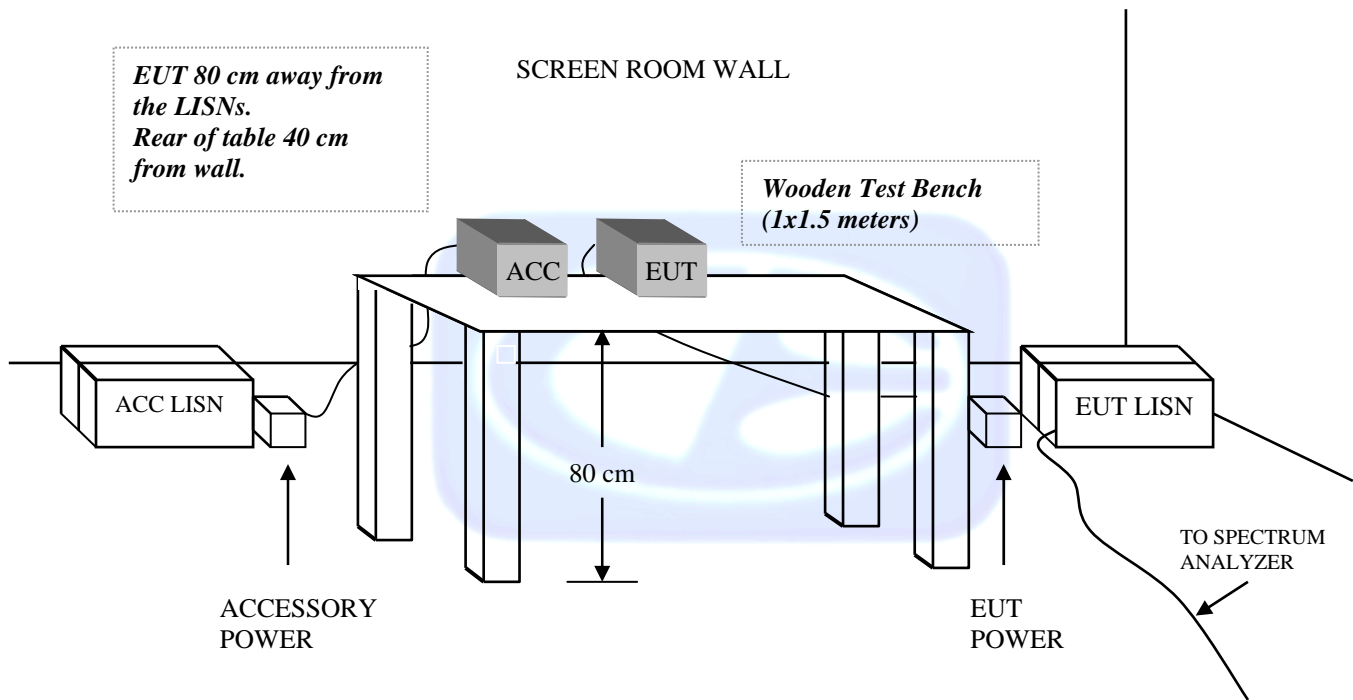
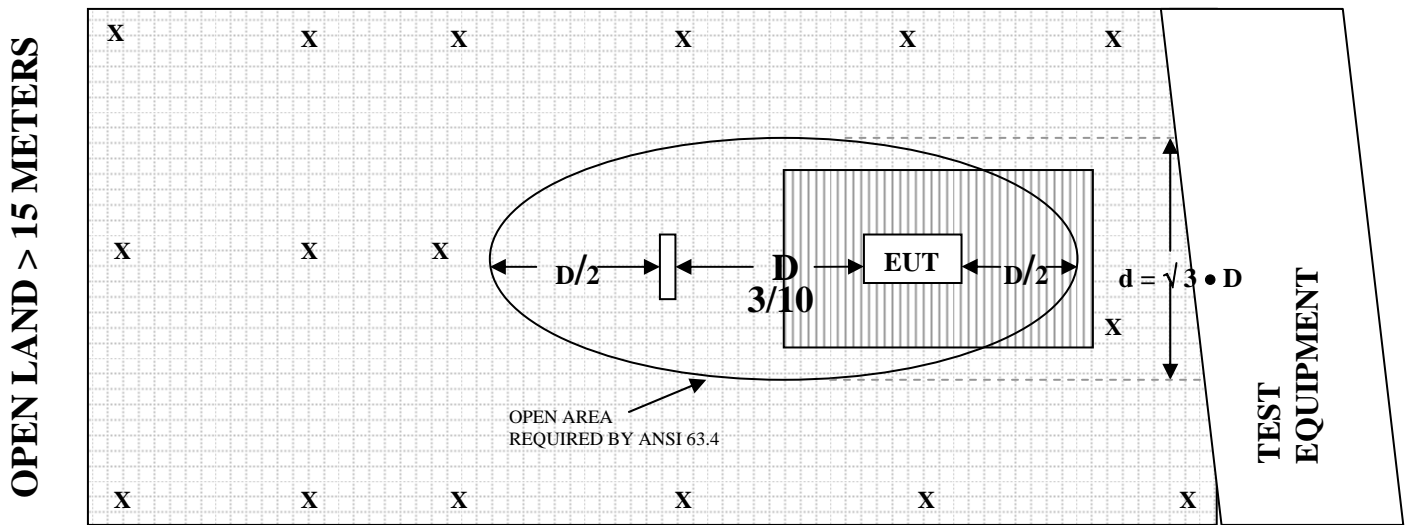

FIGURE 2: PLOT MAP AND LAYOUT OF THE RADIATED TEST SITE

OPEN LAND > 15 METERS



OPEN LAND > 15 METERS

- | | | | |
|----------|--------------------------|--|-----------------|
| X | = GROUND RODS | | = GROUND SCREEN |
| D | = TEST DISTANCE (meters) | | = WOOD COVER |

COM-POWER AL-130**LOOP ANTENNA**

S/N: 17089

CALIBRATION DATE: JANUARY 29, 2013

FREQUENCY (MHz)	MAGNETIC (dB/m)	ELECTRIC (dB/m)
0.009	-42.5	9
0.01	-42.3	9.2
0.02	-42.1	9.4
0.03	-41.4	10.1
0.04	-41.8	9.7
0.05	-42.4	9.1
0.06	-42.3	9.2
0.07	-42.5	9
0.08	-42.4	9.1
0.09	-42.5	9
0.1	-42.5	9
0.2	-42.7	8.8
0.3	-42.6	8.9
0.4	-42.5	9
0.5	-42.7	8.8
0.6	-42.7	8.8
0.7	-42.5	9
0.8	-42.3	9.2
0.9	-42.2	9.3
1	-42.2	9.3
2	-41.8	9.7
3	-41.7	9.8
4	-41.7	9.8
5	-41.5	10
6	-41.6	9.9
7	-41.4	10.1
8	-41	10.5
9	-40.8	10.7
10	-41.3	10.2
15	-41.4	10.1
20	-41.2	10.3
25	-42.6	8.9
30	-41.7	9.8

COM-POWER AC-220**COMBILOG ANTENNA**

S/N: 61027

CALIBRATION DATE: MAY 29, 2013

FREQUENCY (MHz)	FACTOR (dB)	FREQUENCY (MHz)	FACTOR (dB)
30	16.00	120	10.40
35	17.00	125	10.80
40	18.40	140	9.30
45	17.00	150	8.90
50	16.70	160	9.00
60	13.40	175	10.30
70	8.90	180	8.70
80	4.80	200	9.40
90	8.30	250	11.60
100	8.70	300	12.30

COM-POWER AC-220

COMBILOG ANTENNA

S/N: 61027

CALIBRATION DATE: MAY 29, 2013

FREQUENCY (MHz)	FACTOR (dB)	FREQUENCY (MHz)	FACTOR (dB)
300	12.30	700	20.40
350	14.40	750	21.60
400	18.70	800	21.70
450	17.30	850	21.80
500	17.80	900	22.30
550	16.50	950	22.40
600	18.20	1000	23.10
650	19.30		

COM POWER AH-118**HORN ANTENNA**

S/N: 071175

CALIBRATION DATE: FEBRUARY 29, 2012

FREQUENCY (GHz)	FACTOR (dB)	FREQUENCY (GHz)	FACTOR (dB)
1.0	23.6	10.0	37.7
1.5	22.0	10.5	38.4
2.0	28.7	11.0	38.0
2.5	29.3	11.5	38.2
3.0	30.6	12.0	39.0
3.5	30.4	12.5	42.4
4.0	31.1	13.0	40.8
4.5	33.4	13.5	40.0
5.0	35.3	14.0	39.7
5.5	35.1	14.5	43.5
6.0	36.9	15.0	42.7
6.5	37.4	15.5	39.7
7.0	37.6	16.0	39.2
7.5	36.2	16.5	39.7
8.0	38.4	17.0	42.2
8.5	39.3	17.5	47.6
9.0	37.4	18.0	51.2
9.5	38.0		

COM-POWER AH-826**HORN ANTENNA**

S/N: 0071957

FREQUENCY (GHz)	FACTOR (dB)	FREQUENCY (GHz)	FACTOR (dB)
18.0	33.5	22.5	35.5
18.5	33.5	23.0	35.9
19.0	34.0	23.5	35.7
19.5	34.0	24.0	35.6
20.0	34.3	24.5	36.0
20.5	34.9	25.0	36.2
21.0	34.7	25.5	36.1
21.5	35.0	26.0	36.2
22.0	35.0	26.5	35.7

COM-POWER PA-103**PREAMPLIFIER**

S/N: 1582

CALIBRATION DATE: DECEMBER 28, 2012

FREQUENCY (MHz)	FACTOR (dB)	FREQUENCY (MHz)	FACTOR (dB)
30	32.80	300	32.26
40	33.10	350	32.23
50	33.10	400	32.17
60	33.10	450	32.16
70	33.00	500	32.11
80	33.00	550	32.07
90	33.10	600	32.02
100	33.00	650	31.97
125	33.00	700	31.87
150	33.00	750	31.81
175	32.90	800	31.73
200	32.80	850	31.57
225	32.34	900	31.43
250	32.32	950	31.29
275	32.28	1000	31.14

COM-POWER PA-118**PREAMPLIFIER**

S/N: 181656

CALIBRATION DATE: DECEMBER 27, 2012

FREQUENCY (GHz)	FACTOR (dB)	FREQUENCY (GHz)	FACTOR (dB)
1.0	24.68	6.0	25.75
1.1	25.08	6.5	25.28
1.2	25.70	7.0	24.83
1.3	25.98	7.5	24.49
1.4	26.11	8.0	24.38
1.5	26.23	8.5	25.06
1.6	26.34	9.0	25.55
1.7	26.39	9.5	25.32
1.8	26.44	10.0	25.25
1.9	26.45	11.0	24.99
2.0	26.48	12.0	25.08
2.5	26.59	13.0	24.44
3.0	26.67	14.0	25.02
3.5	26.66	15.0	26.12
4.0	26.82	16.0	25.67
4.5	26.46	17.0	24.33
5.0	26.22	18.0	26.75
5.5	25.98		

COM-POWER PA-840**MICROWAVE PREAMPLIFIER**

S/N: 711013

CALIBRATION DATE: MAY 17, 2012

FREQUENCY (GHz)	FACTOR (dB)	FREQUENCY (GHz)	FACTOR (dB)
18.0	25.81	31.0	25.77
19.0	24.57	31.5	25.36
20.0	23.46	32.0	25.15
21.0	22.51	32.5	25.13
22.0	23.85	33.0	25.52
23.0	23.31	33.5	25.24
24.0	24.44	34.0	25.08
25.0	25.42	34.5	25.27
26.0	25.71	35.0	23.99
26.5	25.66	35.5	24.67
27.0	25.84	36.5	24.80
27.5	25.29	37.0	26.27
28.0	25.46	37.5	24.86
28.5	25.58	38.0	24.64
29.0	26.16	38.5	23.46
29.5	26.14	39.0	21.29
30.0	26.01	39.5	20.83
30.5	25.67	40.0	19.96



FRONT VIEW

**BELWITH PRODUCTS, LLC
NORDIC BLE MODULE
MODEL: SRD531
FCC SUBPART B AND C – RADIATED EMISSIONS – ABOVE 30 MHz**

**PHOTOGRAPH SHOWING THE EUT CONFIGURATION
FOR MAXIMUM EMISSIONS**



REAR VIEW

BELWITH PRODUCTS, LLC
NORDIC BLE MODULE
MODEL: SRD531
FCC SUBPART B AND C – RADIATED EMISSIONS – ABOVE 30 MHz

**PHOTOGRAPH SHOWING THE EUT CONFIGURATION
FOR MAXIMUM EMISSIONS**



FRONT VIEW

BELWITH PRODUCTS, LLC
NORDIC BLE MODULE
MODEL: SRD531
FCC SUBPART B AND C – RADIATED EMISSIONS – BELOW 30 MHz

**PHOTOGRAPH SHOWING THE EUT CONFIGURATION
FOR MAXIMUM EMISSIONS**



REAR VIEW

BELWITH PRODUCTS, LLC
NORDIC BLE MODULE
MODEL: SRD531
FCC SUBPART B AND C – RADIATED EMISSIONS – BELOW 30 MHz

**PHOTOGRAPH SHOWING THE EUT CONFIGURATION
FOR MAXIMUM EMISSIONS**



FRONT VIEW

**BELWITH PRODUCTS, LLC
NORDIC BLE MODULE
MODEL: SRD531
FCC SUBPART B AND C – CONDUCTED EMISSIONS**

**PHOTOGRAPH SHOWING THE EUT CONFIGURATION
FOR MAXIMUM EMISSIONS**



REAR VIEW

BELWITH PRODUCTS, LLC
NORDIC BLE MODULE
MODEL: SRD531
FCC SUBPART B AND C – CONDUCTED EMISSIONS

**PHOTOGRAPH SHOWING THE EUT CONFIGURATION
FOR MAXIMUM EMISSIONS**

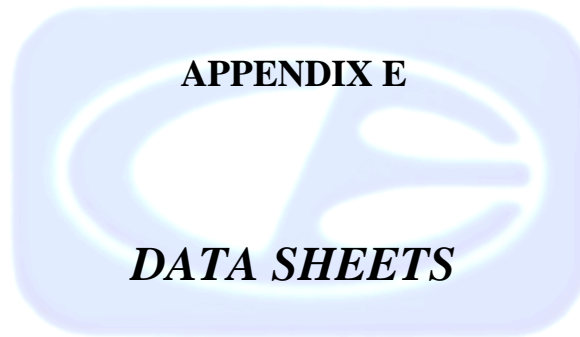

RADIATED EMISSIONS

DATA SHEETS

FCC 15.249

 Belwith Products, LLC
 Nordic BLE Module
 Model: SRD531

 Date:06/24/2013
 Lab: B
 Tested By: Kyle Fujimoto

**250 kHz Bit Mode Worst Case
X-Axis**

Freq. (MHz)	Level (dBuV)	Pol (v/h)	Limit	Margin	Peak / QP / Avg	Ant. Height (m)	Table Angle (deg)	Comments
2402	93.78	V	114	-20.22	Peak	1.25	45	
2402	73.78	V	94	-20.22	Avg	1.25	45	
4804	49.91	V	74	-24.09	Peak	1.25	225	
4804	29.91	V	54	-24.09	Avg	1.25	225	
7206	45.24	V	74	-28.76	Peak	1.25	135	
7206	25.24	V	54	-28.76	Avg	1.25	135	
9608	53.49	V	74	-20.51	Peak	1.25	135	
9608	33.49	V	54	-20.51	Avg	1.25	135	
12010								No Emission Detected
14412								No Emission Detected
16814								No Emission Detected
19216								No Emission Detected
21618								No Emission Detected
24020								No Emission Detected

FCC 15.249

 Belwith Products, LLC
 Nordic BLE Module
 Model: SRD531

 Date:06/24/2013
 Lab: B
 Tested By: Kyle Fujimoto

**250 kHz Bit Mode Worst Case
X-Axis**

Freq. (MHz)	Level (dBuV)	Pol (v/h)	Limit	Margin	Peak / QP / Avg	Ant. Height (m)	Table Angle (deg)	Comments
2402	95.19	H	114	-18.81	Peak	1.25	155	
2402	75.19	H	94	-18.81	Avg	1.25	155	
4804	51.36	H	74	-22.64	Peak	1.35	255	
4804	31.36	H	54	-22.64	Avg	1.35	255	
7206	53.05	H	74	-20.95	Peak	1.25	135	
7206	33.05	H	54	-20.95	Avg	1.25	135	
9608	54.12	H	74	-19.88	Peak	1.35	145	
9608	34.12	H	54	-19.88	Avg	1.35	145	
12010								No Emission Detected
14412								No Emission Detected
16814								No Emission Detected
19216								No Emission Detected
21618								No Emission Detected
24020								No Emission Detected

FCC 15.249

Belwith Products, LLC
 Nordic BLE Module
 Model: SRD531

Date:06/24/2013
 Lab: B
 Tested By: Kyle Fujimoto

**250 kHz Bit Mode Worst Case
 Y-Axis**

Freq. (MHz)	Level (dBUV)	Pol (v/h)	Limit	Margin	Peak / QP / Avg	Ant. Height (m)	Table Angle (deg)	Comments
2402	96.24	V	114	-17.76	Peak	1.25	45	
2402	76.24	V	94	-17.76	Avg	1.25	45	
4804	51.05	V	74	-22.95	Peak	1	135	
4804	31.05	V	54	-22.95	Avg	1	135	
7206	54.18	V	74	-19.82	Peak	1.25	180	
7206	34.18	V	54	-19.82	Avg	1.25	180	
9608	52.49	V	74	-21.51	Peak	1.25	180	
9608	32.49	V	54	-21.51	Avg	1.25	180	
12010								No Emission Detected
12010								
14412								No Emission Detected
14412								
16814								No Emission Detected
16814								
19216								No Emission Detected
19216								
21618								No Emission Detected
21618								
24020								No Emission Detected
24020								

FCC 15.249

Belwith Products, LLC
 Nordic BLE Module
 Model: SRD531

Date:06/24/2013
 Lab: B
 Tested By: Kyle Fujimoto

**250 kHz Bit Mode Worst Case
 Y-Axis**

Freq. (MHz)	Level (dBUV)	Pol (v/h)	Limit	Margin	Peak / QP / Avg	Ant. Height (m)	Table Angle (deg)	Comments
2402	95.15	H	114	-18.85	Peak	1.25	135	
2402	75.15	H	94	-18.85	Avg	1.25	135	
4804	55.91	H	74	-18.09	Peak	1.25	145	
4804	35.91	H	54	-18.09	Avg	1.25	145	
7206	53.91	H	74	-20.09	Peak	1.25	135	
7206	33.91	H	54	-20.09	Avg	1.25	135	
9608	52.25	H	74	-21.75	Peak	1.35	145	
9608	32.25	H	54	-21.75	Avg	1.35	145	
12010								No Emission Detected
14412								No Emission Detected
16814								No Emission Detected
19216								No Emission Detected
21618								No Emission Detected
24020								No Emission Detected

FCC 15.249

Belwith Products, LLC
 Nordic BLE Module
 Model: SRD531

Date:06/24/2013
 Lab: B
 Tested By: Kyle Fujimoto

**250 kHz Bit Mode Worst Case
 Z-Axis**

Freq. (MHz)	Level (dBuV)	Pol (v/h)	Limit	Margin	Peak / QP / Avg	Ant. Height (m)	Table Angle (deg)	Comments
2402	92.39	V	114	-21.61	Peak	1.25	225	
2402	72.39	V	94	-21.61	Avg	1.25	225	
4804	56.42	V	74	-17.58	Peak	1.25	225	
4804	36.42	V	54	-17.58	Avg	1.25	225	
7206	53.62	V	74	-20.38	Peak	1.35	155	
7206	33.62	V	54	-20.38	Avg	1.35	155	
9608	52.78	V	74	-21.22	Peak	1.45	165	
9608	32.78	V	54	-21.22	Avg	1.45	165	
12010								No Emission Detected
14412								No Emission Detected
16814								No Emission Detected
19216								No Emission Detected
21618								No Emission Detected
24020								No Emission Detected

FCC 15.249

Belwith Products, LLC
 Nordic BLE Module
 Model: SRD531

Date:06/24/2013
 Lab: B
 Tested By: Kyle Fujimoto

**250 kHz Bit Mode Worst Case
 Z-Axis**

Freq. (MHz)	Level (dBuV)	Pol (v/h)	Limit	Margin	Peak / QP / Avg	Ant. Height (m)	Table Angle (deg)	Comments
2402	94.73	H	114	-19.27	Peak	1.25	225	
2402	74.73	H	94	-19.27	Avg	1.25	225	
4804	49.88	H	74	-24.12	Peak	1.35	270	
4804	29.88	H	54	-24.12	Avg	1.35	270	
7206	53.38	H	74	-20.62	Peak	1.45	135	
7206	33.38	H	54	-20.62	Avg	1.45	135	
9608	52.75	H	74	-21.25	Peak	1.55	145	
9608	32.75	H	54	-21.25	Avg	1.55	145	
12010								No Emission Detected
14412								No Emission Detected
16814								No Emission Detected
19216								No Emission Detected
21618								No Emission Detected
24020								No Emission Detected

FCC 15.249

Belwith Products, LLC
 Nordic BLE Module
 Model: SRD531

Date:06/24/2013
 Lab: B
 Tested By: Kyle Fujimoto

**250 kHz Bit Mode (Worst Case)
 X-Axis**

Freq. (MHz)	Level (dBuV)	Pol (v/h)	Limit	Margin	Peak / QP / Avg	Ant. Height (m)	Table Angle (deg)	Comments
2440	91.91	V	114	-22.09	Peak	1.25	45	
2440	71.91	V	94	-22.09	Avg	1.25	45	
4880	46.84	V	74	-27.16	Peak	1.25	225	
4880	26.84	V	54	-27.16	Avg	1.25	225	
7320	46.83	V	74	-27.17	Peak	1.25	135	
7320	26.83	V	54	-27.17	Avg	1.25	135	
9760	50.69	V	74	-23.31	Peak	1.25	135	
9760	30.69	V	54	-23.31	Avg	1.25	135	
12200								No Emission Detected
14640								No Emission Detected
17080								No Emission Detected
19520								No Emission Detected
21960								No Emission Detected
24400								No Emission Detected

FCC 15.249

Belwith Products, LLC
 Nordic BLE Module
 Model: SRD531

Date:06/24/2013
 Lab: B
 Tested By: Kyle Fujimoto

**250 kHz Bit Mode (Worst Case)
 X-Axis**

Freq. (MHz)	Level (dBuV)	Pol (v/h)	Limit	Margin	Peak / QP / Avg	Ant. Height (m)	Table Angle (deg)	Comments
2440	93.83	H	114	-20.17	Peak	1.25	155	
2440	73.83	H	94	-20.17	Avg	1.25	155	
4880	50.16	H	74	-23.84	Peak	1.35	255	
4880	30.16	H	54	-23.84	Avg	1.35	255	
7320	52.78	H	74	-21.22	Peak	1.25	135	
7320	32.78	H	54	-21.22	Avg	1.25	135	
9760	49.71	H	74	-24.29	Peak	1.25	135	
9760	29.71	H	54	-24.29	Avg	1.25	135	
12200								No Emission Detected
12200								
14640								No Emission Detected
14640								
17080								No Emission Detected
17080								
19520								No Emission Detected
19520								
21960								No Emission Detected
21960								
24400								No Emission Detected
24400								

FCC 15.249

Belwith Products, LLC
 Nordic BLE Module
 Model: SRD531

Date:06/24/2013
 Lab: B
 Tested By: Kyle Fujimoto

250 kHz Bit Mode (Worst Case)

Y-Axis

Freq. (MHz)	Level (dBuV)	Pol (v/h)	Limit	Margin	Peak / QP / Avg	Ant. Height (m)	Table Angle (deg)	Comments
2440	94.54	V	114	-19.46	Peak	1.25	180	
2440	74.54	V	94	-19.46	Avg	1.25	180	
4880	50.35	V	74	-23.65	Peak	1	135	
4880	30.35	V	54	-23.65	Avg	1	135	
7320	53.28	V	74	-20.72	Peak	1.25	180	
7320	33.28	V	54	-20.72	Avg	1.25	180	
9760	49.21	V	74	-24.79	Peak	1.25	180	
9760	29.21	V	54	-24.79	Avg	1.25	180	
12200								No Emission Detected
14640								No Emission Detected
17080								No Emission Detected
19520								No Emission Detected
21960								No Emission Detected
24400								No Emission Detected

FCC 15.249

Belwith Products, LLC
 Nordic BLE Module
 Model: SRD531

Date:06/24/2013

Lab: B

Tested By: Kyle Fujimoto

250 kHz Bit Mode (Worst Case)

Y-Axis

Freq. (MHz)	Level (dBuV)	Pol (v/h)	Limit	Margin	Peak / QP / Avg	Ant. Height (m)	Table Angle (deg)	Comments
2440	93.87	H	114	-20.13	Peak	1.25	135	
2440	73.87	H	94	-20.13	Avg	1.25	135	
4880	46.28	H	74	-27.72	Peak	1.25	145	
4880	26.28	H	54	-27.72	Avg	1.25	145	
7320	45.93	H	74	-28.07	Peak	1.25	135	
7320	25.93	H	54	-28.07	Avg	1.25	135	
9760	50.89	H	74	-23.11	Peak	1.35	145	
9760	30.89	H	54	-23.11	Avg	1.35	145	
12200								No Emission Detected
14640								No Emission Detected
17080								No Emission Detected
19520								No Emission Detected
21960								No Emission Detected
24400								No Emission Detected

FCC 15.249

Belwith Products, LLC
 Nordic BLE Module
 Model: SRD531

Date:06/24/2013
 Lab: B
 Tested By: Kyle Fujimoto

**250 kHz Bit Mode (Worst Case)
 Z-Axis**

Freq. (MHz)	Level (dBuV)	Pol (v/h)	Limit	Margin	Peak / QP / Avg	Ant. Height (m)	Table Angle (deg)	Comments
2440	92.74	V	114	-21.26	Peak	1.25	225	
2440	72.74	V	94	-21.26	Avg	1.25	225	
4880	49.42	V	74	-24.58	Peak	1.25	225	
4880	29.42	V	54	-24.58	Avg	1.25	225	
7320	49.83	V	74	-24.17	Peak	1.35	155	
7320	29.83	V	54	-24.17	Avg	1.35	155	
9760	51.47	V	74	-22.53	Peak	1.45	165	
9760	31.47	V	54	-22.53	Avg	1.45	165	
12200								No Emission Detected
12200								Detected
14640								No Emission Detected
14640								Detected
17080								No Emission Detected
17080								Detected
19520								No Emission Detected
19520								Detected
21960								No Emission Detected
21960								Detected
24400								No Emission Detected
24400								Detected

FCC 15.249

Belwith Products, LLC
 Nordic BLE Module
 Model: SRD531

Date:06/24/2013
 Lab: B
 Tested By: Kyle Fujimoto

**250 kHz Bit Mode (Worst Case)
 Z-Axis**

Freq. (MHz)	Level (dBuV)	Pol (v/h)	Limit	Margin	Peak / QP / Avg	Ant. Height (m)	Table Angle (deg)	Comments
2440	95.99	H	114	-18.01	Peak	1.25	225	
2440	75.99	H	94	-18.01	Avg	1.25	225	
4880	48.14	H	74	-25.86	Peak	1.35	270	
4880	28.14	H	54	-25.86	Avg	1.35	270	
7320	50.43	H	74	-23.57	Peak	1.45	135	
7320	30.43	H	54	-23.57	Avg	1.45	135	
9760	50.59	H	74	-23.41	Peak	1.55	145	
9760	30.59	H	54	-23.41	Avg	1.55	145	
12200								No Emission Detected
12200								
14640								No Emission Detected
14640								
17080								No Emission Detected
17080								
19520								No Emission Detected
19520								
21960								No Emission Detected
21960								
24400								No Emission Detected
24400								

FCC 15.249

Belwith Products, LLC
 Nordic BLE Module
 Model: SRD531

Date:06/24/2013
 Lab: B
 Tested By: Kyle Fujimoto

**250 kHz Bit Mode (Worst Case)
 X-Axis**

Freq. (MHz)	Level (dBuV)	Pol (v/h)	Limit	Margin	Peak / QP / Avg	Ant. Height (m)	Table Angle (deg)	Comments
2480	89.83	V	114	-24.17	Peak	1.25	155	
2480	69.83	V	94	-24.17	Avg	1.25	155	
4960	48.81	V	74	-25.19	Peak	1.35	165	
4960	28.81	V	54	-25.19	Avg	1.35	165	
7440	47.98	V	74	-26.02	Peak	1.25	175	
7440	27.98	V	54	-26.02	Avg	1.25	175	
9920	49.01	V	74	-24.99	Peak	1.35	185	
9920	29.01	V	54	-24.99	Avg	1.35	185	
12400								No Emission Detected
14880								No Emission Detected
17360								No Emission Detected
19840								No Emission Detected
22320								No Emission Detected
24800								No Emission Detected

FCC 15.249

Belwith Products, LLC
 Nordic BLE Module
 Model: SRD531

Date:06/24/2013
 Lab: B
 Tested By: Kyle Fujimoto

**250 kHz Bit Mode (Worst Case)
 X-Axis**

Freq. (MHz)	Level (dBuV)	Pol (v/h)	Limit	Margin	Peak / QP / Avg	Ant. Height (m)	Table Angle (deg)	Comments
2480	92.47	H	114	-21.53	Peak	1.25	225	
2480	72.47	H	94	-21.53	Avg	1.25	225	
4960	50.93	H	74	-23.07	Peak	1.35	215	
4960	30.93	H	54	-23.07	Avg	1.35	215	
7440	53.07	H	74	-20.93	Peak	1.25	245	
7440	33.07	H	54	-20.93	Avg	1.25	245	
9920	57.46	H	74	-16.54	Peak	1.35	275	
9920	37.46	H	54	-16.54	Avg	1.35	275	
12400								No Emission Detected
12400								Detected
14880								No Emission Detected
14880								Detected
17360								No Emission Detected
17360								Detected
19840								No Emission Detected
19840								Detected
22320								No Emission Detected
22320								Detected
24800								No Emission Detected
24800								Detected

FCC 15.249

Belwith Products, LLC
 Nordic BLE Module
 Model: SRD531

Date:06/24/2013
 Lab: B
 Tested By: Kyle Fujimoto

**250 kHz Bit Mode (Worst Case)
 Y-Axis**

Freq. (MHz)	Level (dBUV)	Pol (v/h)	Limit	Margin	Peak / QP / Avg	Ant. Height (m)	Table Angle (deg)	Comments
2480	91.75	V	114	-22.25	Peak	1.35	225	
2480	71.75	V	94	-22.25	Avg	1.35	225	
4960	47.79	V	74	-26.21	Peak	1.25	165	
4960	27.79	V	54	-26.21	Avg	1.25	165	
7440	45.82	V	74	-28.18	Peak	1.35	175	
7440	25.82	V	54	-28.18	Avg	1.35	175	
9920	50.23	V	74	-23.77	Peak	1.45	185	
9920	30.23	V	54	-23.77	Avg	1.45	185	
12400								No Emission Detected
14880								No Emission Detected
17360								No Emission Detected
19840								No Emission Detected
22320								No Emission Detected
24800								No Emission Detected

FCC 15.249

Belwith Products, LLC
 Nordic BLE Module
 Model: SRD531

Date:06/24/2013
 Lab: B
 Tested By: Kyle Fujimoto

**250 kHz Bit Mode (Worst Case)
 Y-Axis**

Freq. (MHz)	Level (dBuV)	Pol (v/h)	Limit	Margin	Peak / QP / Avg	Ant. Height (m)	Table Angle (deg)	Comments
2480	92.84	H	114	-21.16	Peak	1.25	135	
2480	72.84	H	94	-21.16	Avg	1.25	135	
4960	51.37	H	74	-22.63	Peak	1.35	225	
4960	31.37	H	54	-22.63	Avg	1.35	225	
7440	45.77	H	74	-28.23	Peak	1.25	185	
7440	25.77	H	54	-28.23	Avg	1.25	185	
9920	49.24	H	74	-24.76	Peak	1.35	195	
9920	29.24	H	54	-24.76	Avg	1.35	195	
12400								No Emission Detected
12400								Detected
14880								No Emission Detected
14880								Detected
17360								No Emission Detected
17360								Detected
19840								No Emission Detected
19840								Detected
22320								No Emission Detected
22320								Detected
24800								No Emission Detected
24800								Detected

FCC 15.249

Belwith Products, LLC
 Nordic BLE Module
 Model: SRD531

Date:06/24/2013

Lab: B

Tested By: Kyle Fujimoto

250 kHz Bit Mode (Worst Case)

Z-Axis

Freq. (MHz)	Level (dBuV)	Pol (v/h)	Limit	Margin	Peak / QP / Avg	Ant. Height (m)	Table Angle (deg)	Comments
2480	92.28	V	114	-21.72	Peak	1.25	155	
2480	72.28	V	94	-21.72	Avg	1.25	155	
4960	49.71	V	74	-24.29	Peak	1.35	165	
4960	29.71	V	54	-24.29	Avg	1.35	165	
7440	53.11	V	74	-20.89	Peak	1.25	175	
7440	33.11	V	54	-20.89	Avg	1.25	175	
9920	50.02	V	74	-23.98	Peak	1.35	185	
9920	30.02	V	54	-23.98	Avg	1.35	185	
12400								No Emission Detected
12400								Detected
14880								No Emission Detected
14880								Detected
17360								No Emission Detected
17360								Detected
19840								No Emission Detected
19840								Detected
22320								No Emission Detected
22320								Detected
24800								No Emission Detected
24800								Detected

FCC 15.249

Belwith Products, LLC
 Nordic BLE Module
 Model: SRD531

Date:06/24/2013
 Lab: B
 Tested By: Kyle Fujimoto

**250 kHz Bit Mode (Worst Case)
 Z-Axis**

Freq. (MHz)	Level (dBuV)	Pol (v/h)	Limit	Margin	Peak / QP / Avg	Ant. Height (m)	Table Angle (deg)	Comments
2480	94.58	H	114	-19.42	Peak	1.25	155	
2480	74.58	H	94	-19.42	Avg	1.25	155	
4960	42.18	H	74	-31.82	Peak	1.35	175	
4960	22.18	H	54	-31.82	Avg	1.35	175	
7440	46.01	H	74	-27.99	Peak	1.25	185	
7440	26.01	H	54	-27.99	Avg	1.25	185	
9920	49.72	H	74	-24.28	Peak	1.55	135	
9920	29.72	H	54	-24.28	Avg	1.55	135	
12400								No Emission Detected
12400								Detected
14880								No Emission Detected
14880								Detected
17360								No Emission Detected
17360								Detected
19840								No Emission Detected
19840								Detected
22320								No Emission Detected
22320								Detected
24800								No Emission Detected
24800								Detected

FCC 15.249

Belwith Products, LLC
 Nordic BLE Module
 Model: SRD531

Date: 06/24/2013
 Lab: B
 Tested By: Kyle Fujimoto

Non Harmonic Emissions from the Tx and Digital Portion 1 GHz to 25 GHz

Freq. (MHz)	Level (dBuV)	Pol (v/h)	Limit	Margin	Peak / QP / Avg	Ant. Height (m)	Table Angle (deg)	Comments
								No Emissions Found for the Digital Portion from 1 GHz to 25 GHz for both Vertical and Horizontal Polarizations
								No Non Harmonic Emissions Found for the Tx Mode from 1 GHz to 25 GHz for both Vertical and Horizontal Polarizations
								Investigated in the X, Y, and Z-Axis

Test Location : Compatible Electronics **Page:** 1/1
Customer : Belwith Products, LLC **Date:** 06 / 27 / 2013
Manufacturer : Belwith Products, LLC **Time:** 10:05:53 AM
Eut name : Nordic BLE Module **Lab:** A
Model : SRD531 **Test Distance :** 3.00
Serial # : N/A
Specification : FCC B
Distance correction factor (20 * log(test/spec)) : 0.00
Test Type: Spurious Emissions Qualification Scan
Test Range: 10 kHz to 1 GHz (Horizontal and Vertical)
Test Engineer: James Ross

Pol Freq Rdng Cable Ant Amp Cor'd Limit Delta
MHz dBuV dB dB dB dB dB = R = L R-L
dBuV/m dB

Note 1: Spurious emissions from 10 kHz to 30 MHz were tested at 10 meters
Note 2: No spurious emissions were discovered between 10 kHz and 1 GHz



CONDUCTED EMISSIONS

DATA SHEETS

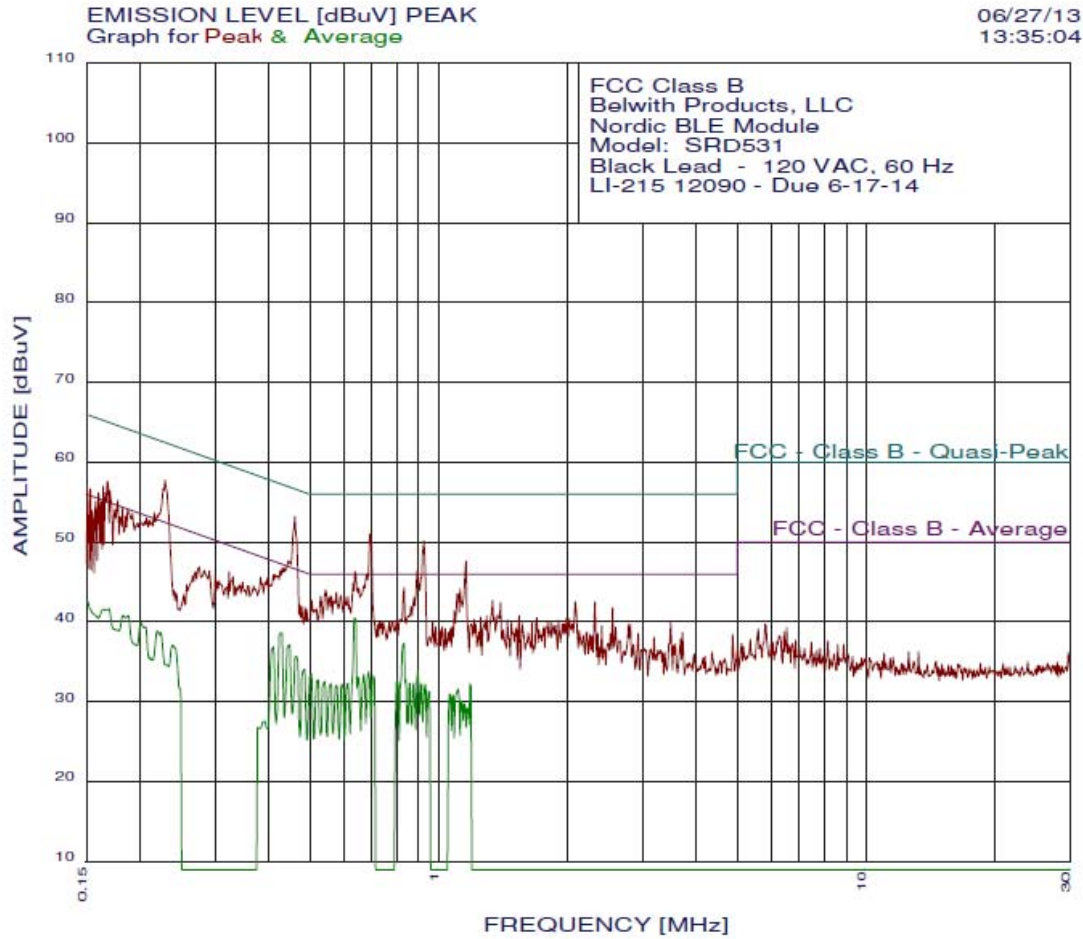

FCC Class B
 Belwith Products, LLC
 Nordic BLE Module
 Model: SRD531
 Black Lead - 120 VAC, 60 Hz
 LI-215 12090 - Due 6-17-14
 Test Engineer: James Ross

06/27/13 13:35:04

 49 highest peaks above -50.00 dB of FCC - Class B - Average limit line
 Peak criteria : 3.00 dB, Curve : Peak

Peak#	Freq(MHz)	Amp(dBuV)	Limit(dB)	Delta(dB)
1	0.461	53.23	46.67	6.57**
2	0.229	57.77	52.48	5.29**
3	0.690	50.98	46.00	4.98**
4	0.924	50.16	46.00	4.16**
5	0.168	57.59	55.07	2.52**
6	0.164	56.99	55.25	1.74**
7	1.160	47.63	46.00	1.63**
8	0.170	56.49	54.94	1.55**
9	0.153	56.69	55.82	0.87**
10	0.151	56.69	55.95	0.74**
11	0.160	56.19	55.47	0.72**
12	0.178	55.28	54.59	0.70**
13	0.637	46.30	46.00	0.30**
14	0.183	54.38	54.37	0.01**
15	0.162	55.09	55.34	-0.25**
16	0.157	55.09	55.60	-0.51**
17	0.831	44.27	46.00	-1.73**
18	0.155	53.99	55.73	-1.74**
19	0.544	44.02	46.00	-1.98**
20	1.338	42.74	46.00	-3.26
21	0.324	46.28	49.62	-3.33
22	2.322	42.55	46.00	-3.45
23	2.089	42.55	46.00	-3.45
24	1.397	42.44	46.00	-3.56
25	0.276	46.88	50.94	-4.06
26	2.554	41.77	46.00	-4.23
27	1.544	40.74	46.00	-5.26
28	1.297	40.74	46.00	-5.26
29	1.256	40.64	46.00	-5.36
30	1.699	40.54	46.00	-5.46
31	1.210	40.33	46.00	-5.67
32	1.449	40.24	46.00	-5.76
33	1.830	40.03	46.00	-5.97
34	3.492	39.99	46.00	-6.01
35	1.480	39.94	46.00	-6.06
36	1.654	39.94	46.00	-6.06
37	1.569	39.84	46.00	-6.16
38	2.811	39.68	46.00	-6.32
39	2.410	39.56	46.00	-6.44
40	3.722	38.70	46.00	-7.30
41	2.932	38.58	46.00	-7.42
42	4.877	38.44	46.00	-7.56
43	3.192	38.09	46.00	-7.91
44	0.150	47.39	56.00	-8.61
45	3.585	37.29	46.00	-8.71
46	5.806	39.76	50.00	-10.24
47	6.525	39.28	50.00	-10.72
48	5.597	39.15	50.00	-10.85
49	6.288	38.27	50.00	-11.73

 **This reading was averaged; please see the previous graph and following data sheet for the averaged information

FCC Class B
 Belwith Products, LLC
 Nordic BLE Module
 Model: SRD531
 Black Lead - 120 VAC, 60 Hz
 LI-215 12090 - Due 6-17-14
 Test Engineer: James Ross

06/27/13 13:35:04

 31 highest peaks above -50.00 dB of FCC - Class B - Average limit line
 Peak criteria : 3.00 dB, Curve : Average

Peak#	Freq(MHz)	Amp(dBuV)	Limit(dB)	Delta(dB)
1	0.634	40.45	46.00	-5.55
2	0.428	38.65	47.28	-8.63
3	0.831	37.32	46.00	-8.68
4	0.447	37.13	46.93	-9.80
5	0.411	36.88	47.63	-10.75
6	0.466	35.70	46.58	-10.87
7	0.486	34.10	46.23	-12.13
8	0.895	33.82	46.00	-12.18
9	0.686	33.78	46.00	-12.22
10	0.505	33.53	46.00	-12.47
11	0.669	33.45	46.00	-12.55
12	0.705	33.25	46.00	-12.75
13	0.521	32.76	46.00	-13.24
14	0.801	32.71	46.00	-13.29
15	0.541	32.60	46.00	-13.40
16	0.150	42.59	56.00	-13.41
17	0.876	32.36	46.00	-13.64
18	0.614	32.31	46.00	-13.69
19	0.858	32.30	46.00	-13.70
20	1.184	32.26	46.00	-13.74
21	0.914	32.26	46.00	-13.74
22	0.561	32.24	46.00	-13.76
23	0.595	32.21	46.00	-13.79
24	0.929	32.17	46.00	-13.83
25	0.577	32.07	46.00	-13.93
26	0.220	38.89	52.83	-13.94
27	1.112	31.59	46.00	-14.41
28	0.948	31.29	46.00	-14.71
29	1.066	30.98	46.00	-15.02
30	1.083	30.83	46.00	-15.17
31	1.130	30.10	46.00	-15.90

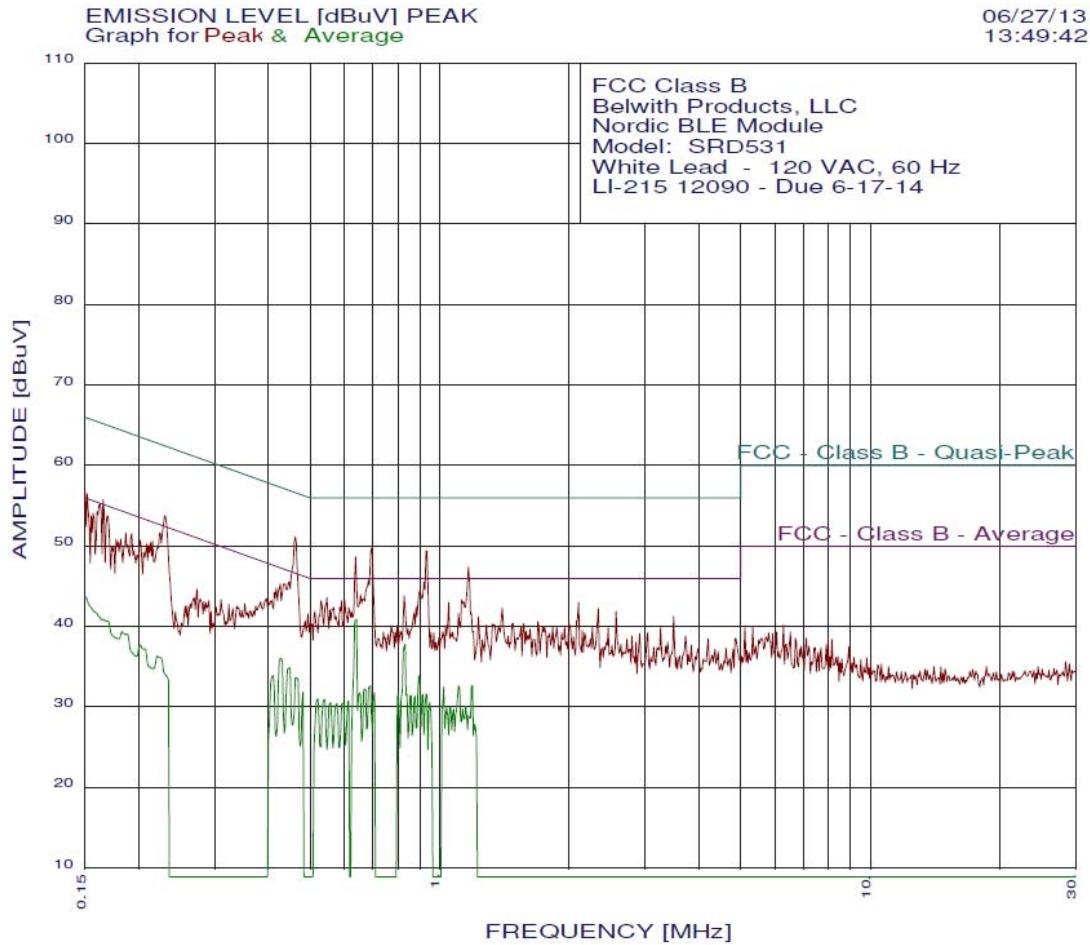

FCC Class B
 Belwith Products, LLC
 Nordic BLE Module
 Model: SRD531
 White Lead - 120 VAC, 60 Hz
 LI-215 12090 - Due 6-17-14
 Test Engineer: James Ross

06/27/13 13:49:42

 49 highest peaks above -50.00 dB of FCC - Class B - Average limit line
 Peak criteria : 3.00 dB, Curve : Peak

Peak#	Freq(MHz)	Amp(dBuV)	Limit(dB)	Delta(dB)
1	0.461	51.13	46.67	4.46**
2	0.694	49.79	46.00	3.79**
3	0.934	49.44	46.00	3.44**
4	0.637	48.70	46.00	2.70**
5	1.166	47.43	46.00	1.43**
6	0.230	53.77	52.43	1.34**
7	0.150	56.69	56.00	0.69
8	0.152	56.49	55.91	0.58**
9	0.165	55.78	55.20	0.58**
10	0.162	55.28	55.34	-0.05**
11	0.169	53.78	55.03	-1.25**
12	0.157	54.09	55.64	-1.56**
13	0.826	43.86	46.00	-2.14**
14	0.547	43.62	46.00	-2.38**
15	0.186	51.66	54.19	-2.53**
16	0.530	43.23	46.00	-2.77**
17	0.592	43.21	46.00	-2.79**
18	2.100	43.04	46.00	-2.96
19	1.049	43.03	46.00	-2.97**
20	1.397	42.33	46.00	-3.67
21	2.334	42.25	46.00	-3.75
22	2.568	41.96	46.00	-4.04
23	3.492	41.30	46.00	-4.70
24	1.230	41.23	46.00	-4.77
25	1.690	40.63	46.00	-5.37
26	1.992	40.44	46.00	-5.56
27	1.569	40.43	46.00	-5.57
28	1.283	40.24	46.00	-5.76
29	1.830	40.13	46.00	-5.87
30	1.735	40.03	46.00	-5.97
31	3.260	39.89	46.00	-6.11
32	2.462	39.86	46.00	-6.14
33	0.273	44.67	51.02	-6.35
34	0.310	43.38	49.97	-6.59
35	3.043	39.27	46.00	-6.73
36	2.916	39.16	46.00	-6.84
37	3.722	38.91	46.00	-7.09
38	2.796	38.86	46.00	-7.14
39	4.877	38.54	46.00	-7.46
40	4.204	38.52	46.00	-7.48
41	6.288	40.28	50.00	-9.72
42	5.114	40.14	50.00	-9.86
43	5.335	40.05	50.00	-9.95
44	6.525	39.38	50.00	-10.62
45	6.059	39.37	50.00	-10.63
46	5.806	39.26	50.00	-10.74
47	7.100	38.59	50.00	-11.41
48	6.700	38.58	50.00	-11.42
49	7.981	38.51	50.00	-11.49

 **This reading was averaged; please see the previous graph and following data sheet for the averaged information

FCC Class B
Belwith Products, LLC
Nordic BLE Module
Model: SRD531
White Lead - 120 VAC, 60 Hz
LI-215 12090 - Due 6-17-14
Test Engineer: James Ross

06/27/13 13:49:42

28 highest peaks above -50.00 dB of FCC - Class B - Average limit line
Peak criteria : 3.00 dB, Curve : Average

Peak#	Freq(MHz)	Amp(dBuV)	Limit(dB)	Delta(dB)
1	0.641	40.89	46.00	-5.11
2	0.831	37.84	46.00	-8.16
3	0.428	36.12	47.28	-11.17
4	0.447	34.96	46.93	-11.97
5	0.895	33.94	46.00	-12.06
6	0.150	43.72	56.00	-12.28
7	0.466	33.67	46.58	-12.91
8	1.191	32.69	46.00	-13.31
9	1.106	32.69	46.00	-13.31
10	0.686	32.67	46.00	-13.33
11	1.021	32.54	46.00	-13.46
12	0.411	33.96	47.63	-13.67
13	0.669	32.30	46.00	-13.70
14	0.705	31.84	46.00	-14.16
15	0.929	31.65	46.00	-14.35
16	0.801	31.65	46.00	-14.35
17	0.914	31.61	46.00	-14.39
18	0.481	31.88	46.32	-14.43
19	0.858	31.50	46.00	-14.50
20	0.876	31.35	46.00	-14.65
21	0.521	31.05	46.00	-14.95
22	0.538	30.95	46.00	-15.05
23	0.614	30.81	46.00	-15.19
24	0.948	30.59	46.00	-15.41
25	0.558	30.57	46.00	-15.43
26	0.577	30.50	46.00	-15.50
27	0.595	30.50	46.00	-15.50
28	1.060	30.00	46.00	-16.00

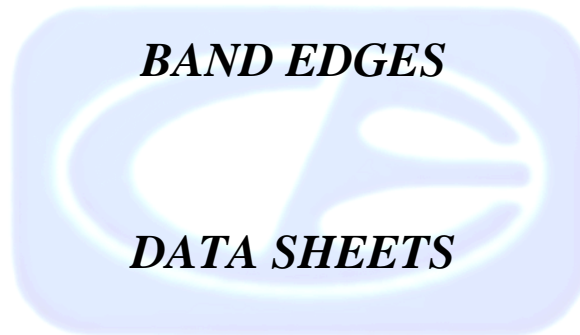

FCC 15.249

 Belwith Products, LLC
 Nordic BLE Module
 Model: SRD531

 Date:06/24/2013
 Lab: B
 Tested By: Kyle Fujimoto

**2 MB / 2 MHz Bandwidth (Worst Case)
Band Edges**

Freq. (MHz)	Level (dBuV)	Pol (v/h)	Limit	Margin	Peak / QP / Avg	Ant. Height (m)	Table Angle (deg)	Comments
2402	96.24	V	114	-17.76	Peak	1.25	45	Fundamental
2402	76.24	V	94	-17.76	Avg	1.25	45	Y-Axis (Worst Case)
2392.91	60.98	V	74	-13.02	Peak	1.25	45	Band Edge
2392.91	40.98	V	54	-13.02	Avg	1.25	45	Y-Axis (Worst Case)
2400	65.15	V	74	-8.85	Peak	1.25	45	Band Edge
2400	45.15	V	54	-8.85	Avg	1.25	45	Y-Axis (Worst Case)
2363	59.14	V	74	-14.86	Peak	1.25	45	Band Edge
2363	39.14	V	54	-14.86	Avg	1.25	45	X-Axis (Worst Case)
2402	95.19	H	114	-18.81	Peak	1.25	155	Fundamental
2402	75.19	H	94	-18.81	Avg	1.25	155	X-Axis (Worst Case)
2392.7	60.33	H	74	-13.67	Peak	1.25	155	Band Edge
2392.7	40.33	H	54	-13.67	Avg	1.25	155	X-Axis (Worst Case)
2400	65.54	H	74	-8.46	Peak	1.25	155	Band Edge
2400	45.54	H	54	-8.46	Avg	1.25	155	X-Axis (Worst Case)
2363	59.12	H	74	-14.88	Peak	1.25	155	Band Edge
2363	39.12	H	54	-14.88	Avg	1.25	155	X-Axis (Worst Case)



Marker 2 [T1] RBW 1 MHz RF Att 10 dB
 Ref Lvl 60.98 dBμV VBW 3 MHz
 102 dBμV 2.39290581 GHz SWT 5 ms Unit dBμV

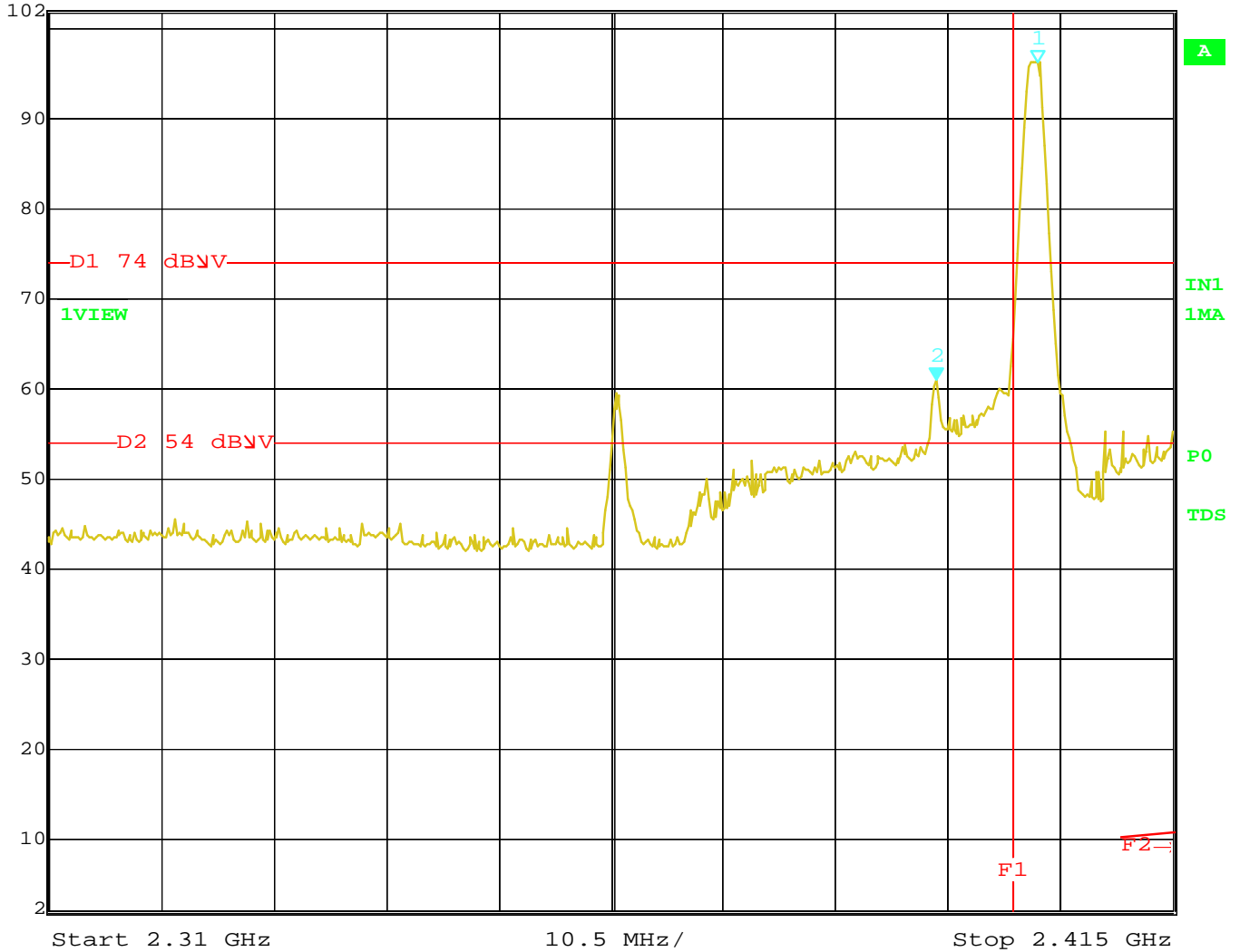

Date: 25.JUN.2013 08:34:12

Band Edge – Low Channel – Vertical Polarization – 2 MBit Mode (Worst Case)

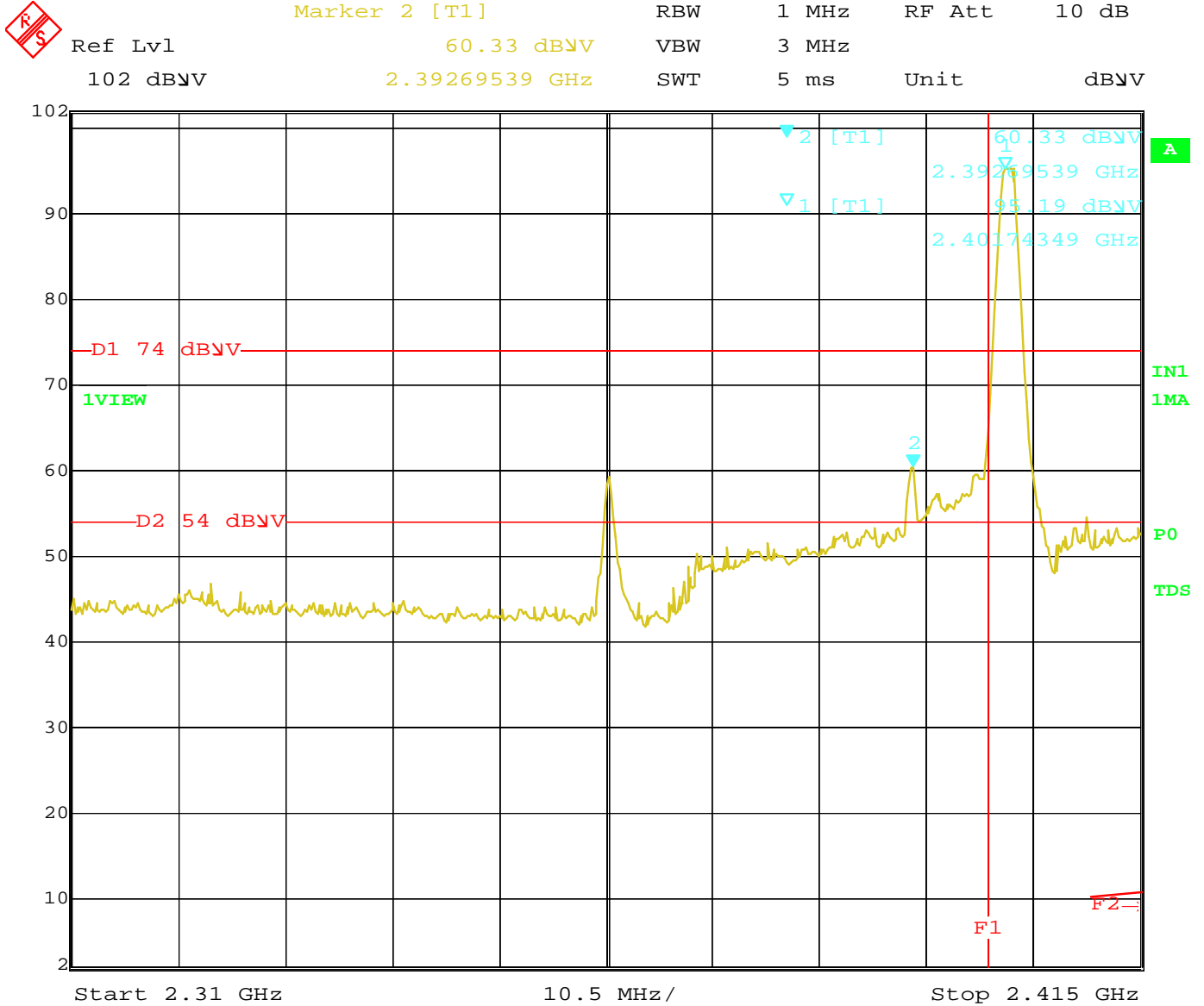

Date: 25.JUN.2013 08:37:00

Band Edge – Low Channel – Horizontal Polarization – 2 MBit Mode (Worst Case)

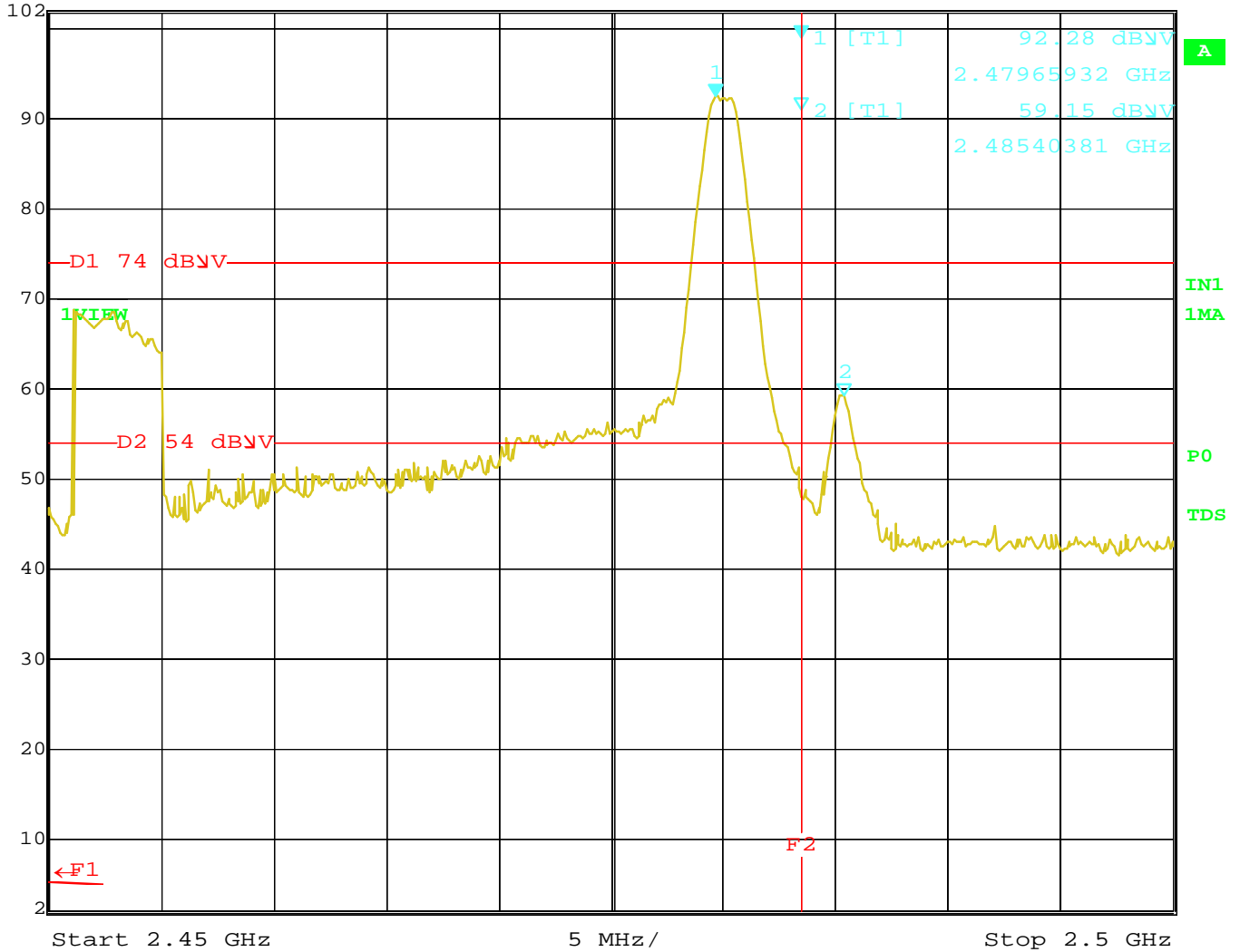

 Marker 1 [T1] RBW 1 MHz RF Att 10 dB
 Ref Lvl 92.28 dBμV VBW 3 MHz
 102 dBμV 2.47965932 GHz SWT 5 ms Unit dBμV



Date: 25.JUN.2013 08:52:59

Band Edge – High Channel – Vertical Polarization – 2 MBit Mode (Worst Case)

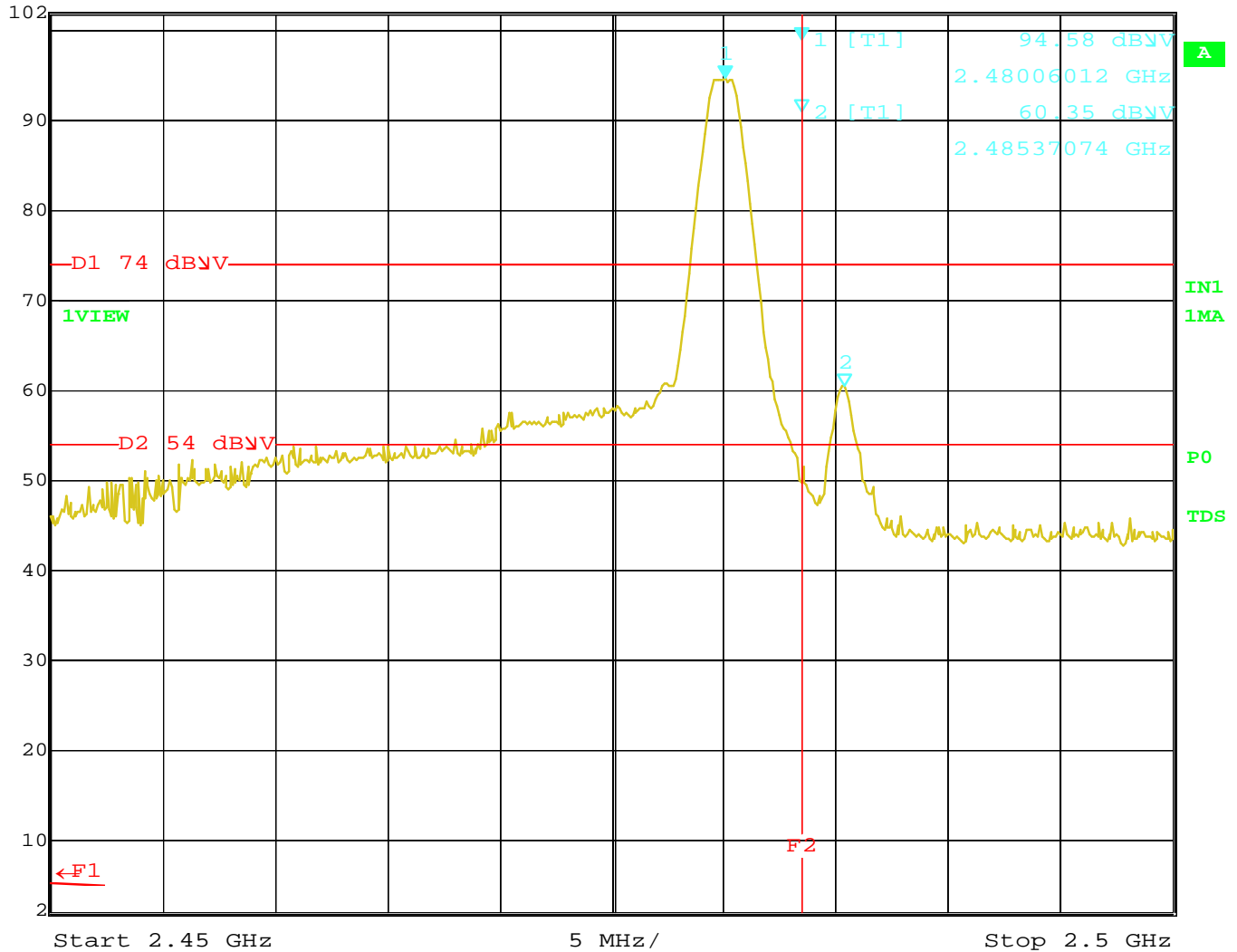
 Marker 1 [T1] RBW 1 MHz RF Att 10 dB
 Ref Lvl 94.58 dBV VBW 3 MHz
 102 dBV 2.48006012 GHz SWT 5 ms Unit dBV



Date: 25.JUN.2013 09:09:35

Band Edge – High Channel – Horizontal Polarization – 2 MBit Mode (Worst Case)