

## FCC Test Report

### (PART 27)

**Report No.:** RF180521C04-1

**FCC ID:** 2AAGMGM01Q

**Test Model:** GM01Q

**Received Date:** May 21, 2018

**Test Date:** Aug. 02, 2018 ~ Aug. 13, 2018

**Issued Date:** Aug. 23, 2018

**Applicant:** SEQUANS Communications SA

**Address:** Portes de la Défense 15-55, Boulevard Charles de Gaulle 92700 Colombes  
France

**Issued By:** Bureau Veritas Consumer Products Services (H.K.) Ltd., Taoyuan Branch

**Lab Address:** No. 47-2, 14th Ling, Chia Pau Vil., Lin Kou Dist., New Taipei City, Taiwan  
( R.O.C )

**Test Location (1):** No. 19, Hwa Ya 2nd Rd, Wen Hwa Vil, Kwei Shan Dist., Taoyuan City  
33383, Taiwan (R.O.C)

**FCC Registration /  
Designation Number:** 788550 / TW0003



This report is for your exclusive use. Any copying or replication of this report to or for any other person or entity, or use of our name or trademark, is permitted only with our prior written permission. This report sets forth our findings solely with respect to the test samples identified herein. The results set forth in this report are not indicative or representative of the quality or characteristics of the lot from which a test sample was taken or any similar or identical product unless specifically and expressly noted. Our report includes all of the tests requested by you and the results thereof based upon the information that you provided to us. You have 60 days from date of issuance of this report to notify us of any material error or omission caused by our negligence, provided, however, that such notice shall be in writing and shall specifically address the issue you wish to raise. A failure to raise such issue within the prescribed time shall constitute your unqualified acceptance of the completeness of this report, the tests conducted and the correctness of the report contents. Unless specific mention, the uncertainty of measurement has been explicitly taken into account to declare the compliance or non-compliance to the specification. The report must not be used by the client to claim product certification, approval, or endorsement by TAF or any government agencies

## Table of Contents

<b>Release Control Record</b> .....	<b>4</b>
<b>1 Certificate of Conformity</b> .....	<b>5</b>
<b>2 Summary of Test Results</b> .....	<b>6</b>
2.1 Measurement Uncertainty .....	7
2.2 Test Site and Instruments .....	8
<b>3 General Information</b> .....	<b>10</b>
3.1 General Description of EUT .....	10
3.2 Configuration of System under Test .....	11
3.2.1 Description of Support Units .....	11
3.3 Test Mode Applicability and Tested Channel Detail .....	12
3.4 EUT Operating Conditions .....	17
3.5 General Description of Applied Standards .....	17
<b>4 Test Types and Results</b> .....	<b>18</b>
4.1 Output Power Measurement .....	18
4.1.1 Limits of Output Power Measurement .....	18
4.1.2 Test Procedures .....	18
4.1.3 Test Setup .....	19
4.1.4 Test Results .....	20
4.2 Modulation Characteristics Measurement .....	38
4.2.1 Limits of Modulation Characteristics .....	38
4.2.2 Test Setup .....	38
4.2.3 Test Procedure .....	38
4.2.4 Test Results .....	39
4.3 Frequency Stability Measurement .....	40
4.3.1 Limits of Frequency Stability Measurement .....	40
4.3.2 Test Procedure .....	40
4.3.3 Test Setup .....	40
4.3.4 Test Results .....	41
4.4 Occupied Bandwidth Measurement .....	51
4.4.1 Limits of Occupied Bandwidth Measurement .....	51
4.4.2 Test Procedure .....	51
4.4.3 Test Setup .....	51
4.4.4 Test Result .....	52
4.5 Band Edge Measurement .....	57
4.5.1 Limits of Band Edge Measurement .....	57
4.5.2 Test Setup .....	57
4.5.3 Test Procedures .....	57
4.5.4 Test Results .....	58
4.6 Peak to Average Ratio .....	68
4.6.1 Limits of Peak to Average Ratio Measurement .....	68
4.6.2 Test Setup .....	68
4.6.3 Test Procedures .....	68
4.6.4 Test Results .....	69
4.7 Conducted Spurious Emissions .....	74
4.7.1 Limits of Conducted Spurious Emissions Measurement .....	74
4.7.2 Test Setup .....	74
4.7.3 Test Procedure .....	74
4.7.4 Test Results .....	75
4.8 Radiated Emission Measurement .....	101
4.8.1 Limits of Radiated Emission Measurement .....	101
4.8.2 Test Procedure .....	101
4.8.3 Deviation from Test Standard .....	101
4.8.4 Test Setup .....	102

4.8.5 Test Results .....	103
<b>5 Pictures of Test Arrangements.....</b>	<b>139</b>
<b>Appendix – Information on the Testing Laboratories .....</b>	<b>140</b>

### Release Control Record

Issue No.	Description	Date Issued
RF180521C04-1	Original Release	Aug. 23, 2018

## 1 Certificate of Conformity

**Product:** GM01Q EZlinkLTE modules

**Brand:** SEQUANS

**Test Model:** GM01Q

**Sample Status:** Mass Product

**Applicant:** SEQUANS Communications SA

**Test Date:** Aug. 02, 2018 ~ Aug. 13, 2018

**Standards:** FCC Part 27, Subpart C, H, L

The above equipment has been tested by **Bureau Veritas Consumer Products Services (H.K.) Ltd., Taoyuan Branch**, and found compliance with the requirement of the above standards. The test record, data evaluation & Equipment Under Test (EUT) configurations represented herein are true and accurate accounts of the measurements of the sample's RF characteristics under the conditions specified in this report.

**Prepared by :** , **Date:** Aug. 23, 2018  
Ivonne Wu / Supervisor

**Approved by :** , **Date:** Aug. 23, 2018  
Dylan Chiou / Project Engineer

## 2 Summary of Test Results

Applied Standard: FCC Part 27 & Part 2 (LTE 4)			
FCC Clause	Test Item	Result	Remarks
2.1046 27.50(d)(4)	Maximum Peak Output Power	Pass	Meet the requirement of limit.
2.1047	Modulation Characteristics	Pass	Meet the requirement.
2.1055 27.54	Frequency Stability	Pass	Meet the requirement of limit.
2.1049 27.53(h)	Occupied Bandwidth	Pass	Meet the requirement of limit.
27.50(d)(5)	Peak to Average Ratio	Pass	Meet the requirement of limit.
27.53(h)	Band Edge Measurements	Pass	Meet the requirement of limit.
2.1051 27.53(h)	Conducted Spurious Emissions	Pass	Meet the requirement of limit.
2.1053 27.53(h)	Radiated Spurious Emissions	Pass	Meet the requirement of limit. Minimum passing margin is -5.14 dB at 5197.00 MHz.

Applied Standard: FCC Part 27 & Part 2 (LTE 12)			
FCC Clause	Test Item	Result	Remarks
2.1046 27.50(c)(10)	Maximum Peak Output Power	Pass	Meet the requirement of limit.
2.1047	Modulation Characteristics	Pass	Meet the requirement.
2.1055 27.54	Frequency Stability	Pass	Meet the requirement of limit.
2.1049 27.53(g)	Occupied Bandwidth	Pass	Meet the requirement of limit.
27.50(d)(5)	Peak to Average Ratio	Pass	Meet the requirement of limit.
27.53(g)	Band Edge Measurements	Pass	Meet the requirement of limit.
2.1051 27.53(g)	Conducted Spurious Emissions	Pass	Meet the requirement of limit.
2.1053 27.53(g)	Radiated Spurious Emissions	Pass	Meet the requirement of limit. Minimum passing margin is -10.61 dB at 2140.50 MHz.

Applied Standard: FCC Part 27 & Part 2 (LTE 66)			
FCC Clause	Test Item	Result	Remarks
2.1046 27.50(d)(4)	Maximum Peak Output Power	Pass	Meet the requirement of limit.
2.1047	Modulation Characteristics	Pass	Meet the requirement.
2.1055 27.54	Frequency Stability	Pass	Meet the requirement of limit.
2.1049 27.53(h)	Occupied Bandwidth	Pass	Meet the requirement of limit.
27.50(d)(5)	Peak to Average Ratio	Pass	Meet the requirement of limit.
27.53(h)	Band Edge Measurements	Pass	Meet the requirement of limit.
2.1051 27.53(h)	Conducted Spurious Emissions	Pass	Meet the requirement of limit.
2.1053 27.53(h)	Radiated Spurious Emissions	Pass	Meet the requirement of limit. Minimum passing margin is -16.56 dB at 5137.50 MHz.

## 2.1 Measurement Uncertainty

Where relevant, the following measurement uncertainty levels have been estimated for tests performed on the EUT as specified in CISPR 16-4-2:

Measurement	Frequency	Expanded Uncertainty (k=2) ( $\pm$ )
Radiated Emissions up to 1 GHz	30 MHz ~ 200 MHz	2.93 dB
	200 MHz ~ 1000 MHz	2.95 dB
Radiated Emissions above 1 GHz	1 GHz ~ 18 GHz	2.26 dB
	18 GHz ~ 40 GHz	1.94 dB

## 2.2 Test Site and Instruments

Description & Manufacturer	Model No.	Serial No.	Date of Calibration	Due Date of Calibration
Test Receiver Agilent	N9038A	MY51210203	Mar. 16, 2018	Mar. 15, 2019
Spectrum Analyzer Agilent	N9010A	MY52220314	Nov. 24, 2017	Nov. 23, 2018
Spectrum Analyzer ROHDE & SCHWARZ	FSU43	100115	Nov. 23, 2017	Nov. 22, 2018
BILOG Antenna SCHWARZBECK	VULB 9168	9168-153	Dec. 06, 2017	Dec. 05, 2018
Double Ridge Guide Horn Antenna EMCO	3115	5619	Nov. 30, 2017	Nov. 29, 2018
BILOG Antenna SCHWARZBECK	VULB 9168	9168-153	Dec. 06, 2017	Dec. 05, 2018
RF signal cable ETS-LINDGREN	5D-FB	Cable-CH1-01(RF C-SMS-100-SMS- 120+RFC-SMS-1 00-SMS-400)	Jun. 19, 2018	Jun. 18, 2019
MXG Vector signal generator Agilent	N5182B	MY53050430	Oct. 24, 2017	Oct. 23, 2018
Preamplifier EMCI	EMC 012645	980115	Oct. 20, 2017	Oct. 19, 2018
Preamplifier EMCI	EMC 184045	980116	Oct. 20, 2017	Oct. 19, 2018
Preamplifier EMCI	EMC 330H	980112	Oct. 13, 2017	Oct. 12, 2018
Power Meter Anritsu	ML2495A	1012010	Aug. 15, 2017	Aug. 14, 2018
Power Sensor Anritsu	MA2411B	1315050	Aug. 15, 2017	Aug. 14, 2018
RF Coaxial Cable HUBER+SUHNNER	EMC104-SM-SM-800 0&3000	140811+170717	Oct. 20, 2017	Oct. 19, 2018
RF Coaxial Cable HUBER+SUHNNER	SUCOFLEX 104	EMC104-SM-SM- 1000(140807)	Oct. 20, 2017	Oct. 19, 2018
RF Coaxial Cable Worken	8D-FB	Cable-Ch10-01	Oct. 20, 2017	Oct. 19, 2018
Boresight Antenna Fixture	FBA-01	FBA-SIP01	NA	NA
Software BV ADT	E3 6.120103	NA	NA	NA
Antenna Tower MF	MFA-440H	NA	NA	NA
Turn Table MF	MFT-201SS	NA	NA	NA
Antenna Tower & Turn Table Controller MF	MF-7802	NA	NA	NA
LTE Wireless Communication Test Set Keysight	E7515A	MY56030229	Mar. 14, 2018	Mar. 13, 2019
Temperature & Humidity Chamber	GTH-120-40-CP-AR	MAA1306-019	Sep. 08, 2017	Sep. 07, 2018
DC Power Supply Topward	33010D	807748	Oct. 25, 2016	Oct. 24, 2018
Digital Multimeter Fluke	87-III	70360742	Jun. 29, 2018	Jun. 28, 2019



- Note:
1. The calibration interval of the above test instruments is 12 / 24 months and the calibrations are traceable to NML/ROC and NIST/USA.
  2. The test was performed in HwaYa Chamber 10.
  3. The horn antenna and preamplifier (model: EMC 184045) are used only for the measurement of emission frequency above 1 GHz if tested.
  4. The IC Site Registration No. is IC7450F-10.

### 3 General Information

#### 3.1 General Description of EUT

<b>Product</b>	GM01Q EZlinkLTE modules	
<b>Brand</b>	SEQUANS	
<b>Test Model</b>	GM01Q	
<b>Status of EUT</b>	Mass Product	
<b>Power Supply Rating</b>	5.0 Vdc (adapter)	
<b>Modulation Type</b>	LTE	QPSK, 16QAM
<b>Frequency Range</b>	LTE Band 4 (Channel Bandwidth: 5 MHz)	1712.5 ~ 1752.5 MHz
	LTE Band 4 (Channel Bandwidth: 10 MHz)	1715.0 ~ 1750.0 MHz
	LTE Band 4 (Channel Bandwidth: 15 MHz)	1717.5 ~ 1747.5 MHz
	LTE Band 4 (Channel Bandwidth: 20 MHz)	1720.0 ~ 1745.0 MHz
	LTE Band 12 (Channel Bandwidth: 5 MHz)	701.5 ~ 713.5 MHz
	LTE Band 12 (Channel Bandwidth: 10 MHz)	704.0 ~ 711.0 MHz
	LTE Band 66 (Channel Bandwidth: 5 MHz)	1712.5 ~ 1777.5 MHz
	LTE Band 66 (Channel Bandwidth: 10 MHz)	1715.0 ~ 1775.0 MHz
	LTE Band 66 (Channel Bandwidth: 15 MHz)	1717.5 ~ 1772.5 MHz
	LTE Band 66 (Channel Bandwidth: 20 MHz)	1720.0 ~ 1770.0 MHz
<b>Emission Designator</b>	LTE Band 4 (Channel Bandwidth: 5 MHz)	1M10G7D
	LTE Band 4 (Channel Bandwidth: 10 MHz)	1M09G7D
	LTE Band 4 (Channel Bandwidth: 15 MHz)	1M10G7D
	LTE Band 4 (Channel Bandwidth: 20 MHz)	1M10G7D
	LTE Band 12 (Channel Bandwidth: 5 MHz)	1M09G7D
	LTE Band 12 (Channel Bandwidth: 10 MHz)	1M09G7D
	LTE Band 66 (Channel Bandwidth: 5 MHz)	1M10G7D
	LTE Band 66 (Channel Bandwidth: 10 MHz)	1M09G7D
	LTE Band 66 (Channel Bandwidth: 15 MHz)	1M09G7D
	LTE Band 66 (Channel Bandwidth: 20 MHz)	1M10G7D
<b>Max. ERP Power</b>	LTE Band 12 (Channel Bandwidth: 5 MHz)	407.38 mW
	LTE Band 12 (Channel Bandwidth: 10 MHz)	379.31 mW
<b>Max. EIRP Power</b>	LTE Band 4 (Channel Bandwidth: 5 MHz)	328.85 mW
	LTE Band 4 (Channel Bandwidth: 10 MHz)	311.17 mW
	LTE Band 4 (Channel Bandwidth: 15 MHz)	295.80 mW
	LTE Band 4 (Channel Bandwidth: 20 MHz)	280.54 mW
	LTE Band 66 (Channel Bandwidth: 5 MHz)	375.84 mW
	LTE Band 66 (Channel Bandwidth: 10 MHz)	354.81 mW
	LTE Band 66 (Channel Bandwidth: 15 MHz)	336.51 mW
	LTE Band 66 (Channel Bandwidth: 20 MHz)	319.89 mW
<b>Antenna Type</b>	Fixed External Antenna with 3 dBi gain	
<b>Accessory Device</b>	Refer to Note as below	
<b>Data Cable Supplied</b>	Refer to Note as below	

Note:

1. The above EUT information is declared by manufacturer and for more detailed features description, please refers to the manufacturer's specifications or user's manual.

### 3.2 Configuration of System under Test

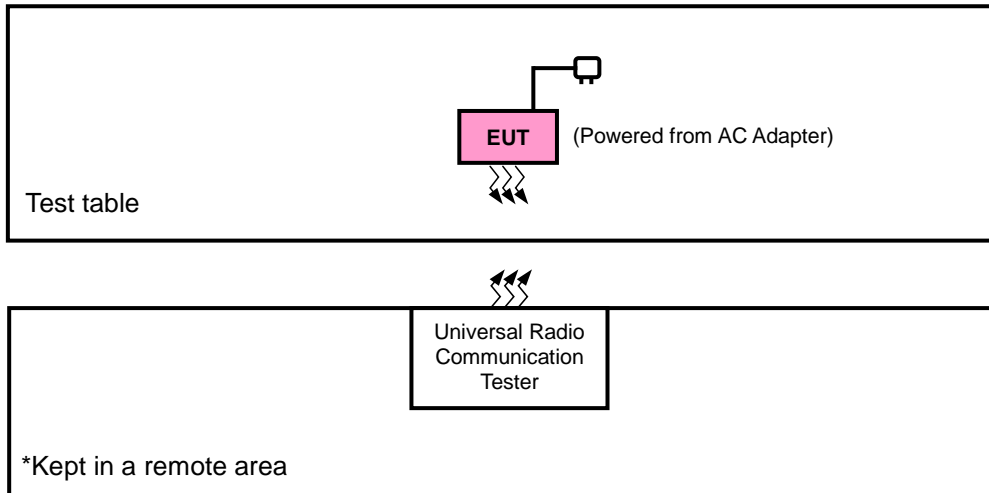

#### 3.2.1 Description of Support Units

The EUT has been tested as an independent unit together with other necessary accessories or support units.

### 3.3 Test Mode Applicability and Tested Channel Detail

Pre-Scan has been conducted to determine the worst-case mode from all possible combinations between available modulations, data rates, XYZ axis, and antenna ports

The worst case was found when positioned as the table below. Following channel(s) was (were) selected for the final test as listed below:

Band	ERP / EIRP	Radiated Emission
LTE Band 4	X-plane	X-axis
LTE Band 12	X-plane	Z-axis
LTE Band 66	X-plane	X-axis

#### LTE Band 4

EUT Configure Mode	Test Item	Available Channel	Tested Channel	Channel Bandwidth	Modulation	Mode
-	EIRP	19975 to 20375	19975, 20175, 20375	5 MHz	QPSK, 16QAM	1 RB / 0 RB Offset
		20000 to 20350	20000, 20175, 20350	10 MHz	QPSK, 16QAM	1 RB / 0 RB Offset
		20025 to 20325	20025, 20175, 20325	15 MHz	QPSK, 16QAM	1 RB / 0 RB Offset
		20050 to 20300	20050, 20175, 20300	20 MHz	QPSK, 16QAM	1 RB / 0 RB Offset
-	Modulation Characteristics	20050 to 20300	20175	10 MHz	QPSK, 16QAM	1 RB / 0 RB Offset
-	Frequency Stability	19975 to 20375	19975, 20375	5 MHz	QPSK	1 RB / 0 RB Offset
		20000 to 20350	20000, 20350	10 MHz	QPSK	1 RB / 0 RB Offset
		20025 to 20325	20025, 20325	15 MHz	QPSK	1 RB / 0 RB Offset
		20050 to 20300	20050, 20300	20 MHz	QPSK	1 RB / 0 RB Offset
-	Occupied Bandwidth	19975 to 20375	19975, 20175, 20375	5 MHz	QPSK, 16QAM	25 RB / 0 RB Offset
		20000 to 20350	20000, 20175, 20350	10 MHz	QPSK, 16QAM	50 RB / 0 RB Offset
		20025 to 20325	20025, 20175, 20325	15 MHz	QPSK, 16QAM	75 RB / 0 RB Offset
		20050 to 20300	20050, 20175, 20300	20 MHz	QPSK, 16QAM	100 RB / 0 RB Offset
-	Peak to Average Ratio	19975 to 20375	19975, 20175, 20375	5 MHz	QPSK, 16QAM	1 RB / 0 RB Offset
		20000 to 20350	20000, 20175, 20350	10 MHz	QPSK, 16QAM	1 RB / 0 RB Offset
		20025 to 20325	20025, 20175, 20325	15 MHz	QPSK, 16QAM	1 RB / 0 RB Offset
		20050 to 20300	20050, 20175, 20300	20 MHz	QPSK, 16QAM	1 RB / 0 RB Offset

EUT Configure Mode	Test Item	Available Channel	Tested Channel	Channel Bandwidth	Modulation	Mode		
-	Band Edge	19975 to 20375	19975	5 MHz	QPSK	1 RB / 0 RB Offset 25 RB / 0 RB Offset		
			20375	5 MHz	QPSK	1 RB / 24 RB Offset 25 RB / 0 RB Offset		
		20000 to 20350	20000	10 MHz	QPSK	1 RB / 0 RB Offset 50 RB / 0 RB Offset		
			20350	10 MHz	QPSK	1 RB / 49 RB Offset 50 RB / 0 RB Offset		
		20025 to 20325	20025	15 MHz	QPSK	1 RB / 0 RB Offset 75 RB / 0 RB Offset		
			20325	15 MHz	QPSK	1 RB / 74 RB Offset 75 RB / 0 RB Offset		
		20050 to 20300	20050	20 MHz	QPSK	1 RB / 0 RB Offset 100 RB / 0 RB Offset		
			20300	20 MHz	QPSK	1 RB / 99 RB Offset 100 RB / 0 RB Offset		
		-	Conducted Emission	19975 to 20375	19975, 20175, 20375	5 MHz	QPSK	1 RB / 0 RB Offset
				20000 to 20350	20000, 20175, 20350	10 MHz	QPSK	1 RB / 0 RB Offset
				20025 to 20325	20025, 20175, 20325	15 MHz	QPSK	1 RB / 0 RB Offset
				20050 to 20300	20050, 20175, 20300	20 MHz	QPSK	1 RB / 0 RB Offset
-	Radiated Emission	19975 to 20375	19975, 20175, 20375	5 MHz	QPSK	1 RB / 0 RB Offset		
		20050 to 20300	20050, 20175, 20300	20 MHz	QPSK	1 RB / 0 RB Offset		

**Note:** This device was tested under all bandwidths, RB configurations and modulations. The worst case was found in QPSK modulation.

## LTE Band 12

EUT Configure Mode	Test Item	Available Channel	Tested Channel	Channel Bandwidth	Modulation	Mode
-	ERP	23035 to 23155	23035, 23095, 23155	5 MHz	QPSK, 16QAM	1 RB / 0 RB Offset
		23060 to 23130	23060, 23095, 23130	10 MHz	QPSK, 16QAM	1 RB / 0 RB Offset
-	Modulation Characteristics	23060 to 23130	23095	10 MHz	QPSK, 16QAM	1 RB / 0 RB Offset
-	Frequency Stability	23035 to 23155	23035, 23155	5 MHz	QPSK	1 RB / 0 RB Offset
		23060 to 23130	23060, 23130	10 MHz	QPSK	1 RB / 0 RB Offset
-	Occupied Bandwidth	23035 to 23155	23035, 23095, 23155	5 MHz	QPSK, 16QAM	25 RB / 0 RB Offset
		23060 to 23130	23060, 23095, 23130	10 MHz	QPSK, 16QAM	50 RB / 0 RB Offset
-	Peak to Average Ratio	23035 to 23155	23035, 23095, 23155	5 MHz	QPSK, 16QAM	1 RB / 0 RB Offset
		23060 to 23130	23060, 23095, 23130	10 MHz	QPSK, 16QAM	1 RB / 0 RB Offset
-	Band Edge	23035 to 23155	23035	5 MHz	QPSK	1 RB / 0 RB Offset
			23155	5 MHz	QPSK	25 RB / 0 RB Offset
		23060 to 23130	23060	10 MHz	QPSK	1 RB / 24 RB Offset
			23130	10 MHz	QPSK	25 RB / 0 RB Offset
			23060	10 MHz	QPSK	1 RB / 0 RB Offset
			23130	10 MHz	QPSK	50 RB / 0 RB Offset
-	Conducted Emission	23035 to 23155	23035, 23095, 23155	5 MHz	QPSK	1 RB / 0 RB Offset
		23060 to 23130	23060, 23095, 23130	10 MHz	QPSK	1 RB / 0 RB Offset
-	Radiated Emission	23035 to 23155	23035, 23095, 23155	5 MHz	QPSK	1 RB / 0 RB Offset
		23060 to 23130	23060, 23095, 23130	10 MHz	QPSK	1 RB / 0 RB Offset

**Note:** This device was tested under all bandwidths, RB configurations and modulations. The worst case was found in QPSK modulation.

### LTE Band 66

EUT Configure Mode	Test Item	Available Channel	Tested Channel	Channel Bandwidth	Modulation	Mode
-	EIRP	131997 to 132647	131997, 132322, 132647	5 MHz	QPSK, 16QAM	1 RB / 0 RB Offset
		132022 to 132622	132022, 132322, 132622	10 MHz	QPSK, 16QAM	1 RB / 0 RB Offset
		132047 to 132597	132047, 132322, 132597	15 MHz	QPSK, 16QAM	1 RB / 0 RB Offset
		132072 to 132572	132072, 132322, 132572	20 MHz	QPSK, 16QAM	1 RB / 0 RB Offset
-	Modulation Characteristics	132072 to 132572	132322	10 MHz	QPSK, 16QAM	1 RB / 0 RB Offset
-	Frequency Stability	131997 to 132647	131997, 132647	5 MHz	QPSK	1 RB / 0 RB Offset
		132022 to 132622	132022, 132622	10 MHz	QPSK	1 RB / 0 RB Offset
		132047 to 132597	132047, 132597	15 MHz	QPSK	1 RB / 0 RB Offset
		132072 to 132572	132072, 132572	20 MHz	QPSK	1 RB / 0 RB Offset
-	Occupied Bandwidth	131997 to 132647	131997, 132322, 132647	5 MHz	QPSK, 16QAM	25 RB / 0 RB Offset
		132022 to 132622	132022, 132322, 132622	10 MHz	QPSK, 16QAM	50 RB / 0 RB Offset
		132047 to 132597	132047, 132322, 132597	15 MHz	QPSK, 16QAM	75 RB / 0 RB Offset
		132072 to 132572	132072, 132322, 132572	20 MHz	QPSK, 16QAM	100 RB / 0 RB Offset
-	Peak to Average Ratio	131997 to 132647	131997, 132322, 132647	5 MHz	QPSK, 16QAM	1 RB / 0 RB Offset
		132022 to 132622	132022, 132322, 132622	10 MHz	QPSK, 16QAM	1 RB / 0 RB Offset
		132047 to 132597	132047, 132322, 132597	15 MHz	QPSK, 16QAM	1 RB / 0 RB Offset
		132072 to 132572	132072, 132322, 132572	20 MHz	QPSK, 16QAM	1 RB / 0 RB Offset

EUT Configure Mode	Test Item	Available Channel	Tested Channel	Channel Bandwidth	Modulation	Mode		
-	Band Edge	131997 to 132647	131997	5 MHz	QPSK	1 RB / 0 RB Offset 25 RB / 0 RB Offset		
			132647	5 MHz	QPSK	1 RB / 24 RB Offset 25 RB / 0 RB Offset		
		132022 to 132622	132022	10 MHz	QPSK	1 RB / 0 RB Offset 50 RB / 0 RB Offset		
			132622	10 MHz	QPSK	1 RB / 49 RB Offset 50 RB / 0 RB Offset		
		132047 to 132597	132047	15 MHz	QPSK	1 RB / 0 RB Offset 75 RB / 0 RB Offset		
			132597	15 MHz	QPSK	1 RB / 74 RB Offset 75 RB / 0 RB Offset		
		132072 to 132572	132072	20 MHz	QPSK	1 RB / 0 RB Offset 100 RB / 0 RB Offset		
			132572	20 MHz	QPSK	1 RB / 99 RB Offset 100 RB / 0 RB Offset		
		-	Conducted Emission	131997 to 132647	131997, 132322, 132647	5 MHz	QPSK	1 RB / 0 RB Offset
				132022 to 132622	132022, 132322, 132622	10 MHz	QPSK	1 RB / 0 RB Offset
				132047 to 132597	132047, 132322, 132597	15 MHz	QPSK	1 RB / 0 RB Offset
				132072 to 132572	132072, 132322, 132572	20 MHz	QPSK	1 RB / 0 RB Offset
-	Radiated Emission	131997 to 132647	131997, 132322, 132647	5 MHz	QPSK	1 RB / 0 RB Offset		
		132072 to 132572	132072, 132322, 132572	20 MHz	QPSK	1 RB / 0 RB Offset		

**Test Condition:**

Test Item	Environmental Conditions	Input Power	Tested By
ERP / EIRP	25 deg. C, 65 % RH	120 Vac, 60 Hz	Thomas Wei
Modulation Characteristics	25 deg. C, 65 % RH	3.8 Vdc	Getaz Yang
Frequency Stability	25 deg. C, 65 % RH	3.8 Vdc	Getaz Yang
Occupied Bandwidth	25 deg. C, 65 % RH	3.8 Vdc	Getaz Yang
Band Edge	25 deg. C, 65 % RH	3.8 Vdc	Getaz Yang
Peak to Average Ratio	25 deg. C, 65 % RH	3.8 Vdc	Getaz Yang
Conducted Emission	25 deg. C, 65 % RH	3.8 Vdc	Getaz Yang
Radiated Emission	25 deg. C, 65 % RH	120 Vac, 60 Hz	Thomas Wei



### **3.4 EUT Operating Conditions**

The EUT makes a call to the communication simulator. The communication simulator station system controlled a EUT to export maximum output power under transmission mode and specific channel frequency

### **3.5 General Description of Applied Standards**

The EUT is a RF Product. According to the specifications of the manufacturer, it must comply with the requirements of the following standards:

**FCC 47 CFR Part 2**

**FCC 47 CFR Part 27**

**KDB 971168 D01 Power Meas License Digital Systems v03r01**

**ANSI/TIA/EIA-603-E 2016**

**ANSI 63.26-2015**

**Note:** All test items have been performed and recorded as per the above standards.

## 4 Test Types and Results

### 4.1 Output Power Measurement

#### 4.1.1 Limits of Output Power Measurement

Fixed, mobile, and portable (hand-held) stations operating in the 1710–1755 MHz band are limited to 1 watt EIRP.

Portable stations (hand-held devices) operating in the 704-716 MHz band are limited to 3 watts ERP

#### 4.1.2 Test Procedures

##### **EIRP / ERP Measurement:**

- a. All measurements were done at low, middle and high operational frequency range. RBW and VBW is 5 MHz for WCDMA and 10 MHz for LTE mode.
- b. Substitution method is used for E.I.R.P measurement. In the semi-anechoic chamber, EUT placed on the 0.8 m (below or equal 1 GHz) and/or 1.5 m (above 1 GHz) height of Turn Table, rotated the table around 360 degrees to search the maximum radiation power and receiver antenna shall be rotated vertical and horizontal polarization and moved height from 1 m to 4 m to find the maximum polar radiated power. The “Read Value” is the spectrum reading the maximum power value.
- c. The substitution horn antenna is substituted for EUT at the same position and signals generator export the CW signal to the substitution antenna via a tx cable. Rotated the Turn Table and moved receiving antenna to find the maximum radiation power. Adjust output power level of S.G to get a Value of spectrum reading equal to “Read Value” of step b. Record the power level of S.G.
- d.  $EIRP = \text{Output power level of S.G} - \text{TX cable loss} + \text{Antenna gain of substitution horn}$ . E.R.P power can be calculated form E.I.R.P power by subtracting the gain of dipole,  $E.R.P \text{ power} = E.I.R.P \text{ power} - 2.15 \text{ dB}$ .

##### **Conducted Power Measurement:**

- a. The EUT was set up for the maximum power with LTE link data modulation and link up with simulator.
- b. Set the EUT to transmit under low, middle and high channel and record the power level shown on simulator.

### 4.1.3 Test Setup

#### EIRP / ERP Measurement:

<Radiated Emission below or equal 1 GHz>

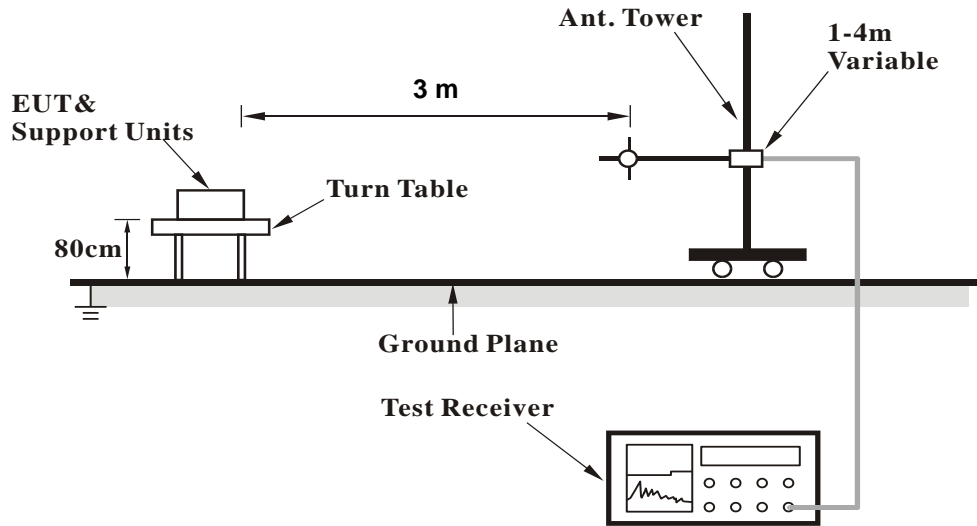

<Radiated Emission above 1 GHz>

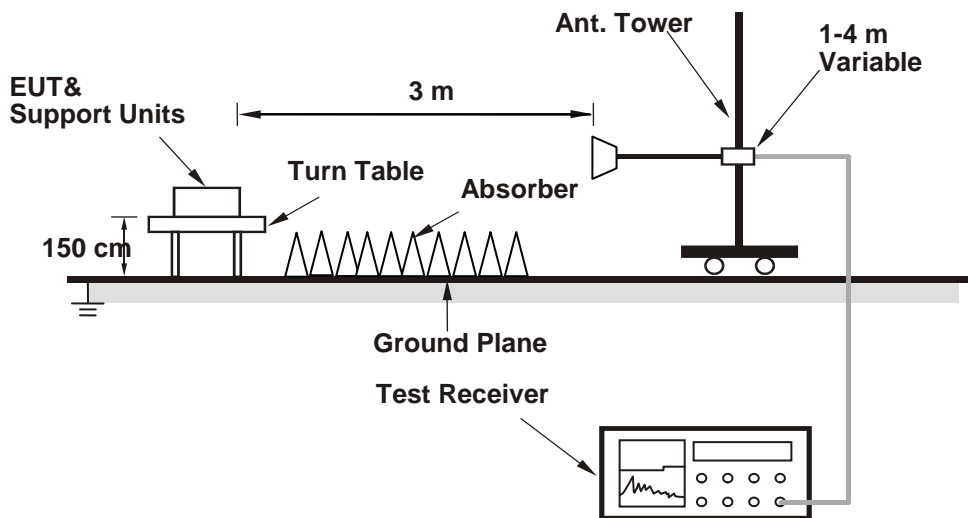

For the actual test configuration, please refer to the attached file (Test Setup Photo).

#### Conducted Power Measurement:

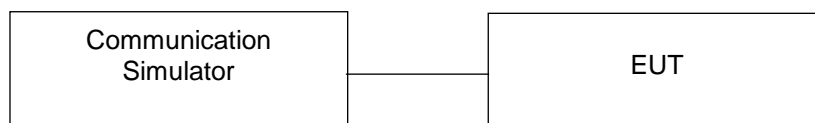

4.1.4 Test Results

**Conducted Output Power (dBm)**

**LTE Band 4**

BW (MHz): 5										
Test Frequency ID	N <sub>UL</sub>	Frequency of Uplink [MHz]	N <sub>DL</sub>	Frequency of Downlink [MHz]	Test Configuration Initial of Power				EUT	
					Modulation	RB Size	RB Offset	Narrowband Index	Cell power (dBm/15kHz)	power (dBm)
Low Range	19975	1712.5	1975	2112.5	QPSK	1	0	0	-85	22.9
					QPSK	1	5	0	-85	22.88
					QPSK	1	0	1	-85	22.95
					QPSK	1	5	1	-85	22.93
					QPSK	1	0	3	-85	22.91
					QPSK	1	5	3	-85	22.9
					QPSK	3	0	0	-85	22.14
					QPSK	3	3	3	-85	22.16
					QPSK	6	0	0	-85	22.09
					QPSK	6	0	1	-85	22.11
					QPSK	6	0	3	-85	22.04
					16QAM	1	0	0	-85	22.62
					16QAM	1	5	0	-85	22.87
					16QAM	1	0	1	-85	22.88
					16QAM	1	5	1	-85	22.87
					16QAM	1	0	3	-85	22.82
					16QAM	1	5	3	-85	22.57
					16QAM	3	0	0	-85	21.8
					16QAM	3	3	3	-85	22.86
					16QAM	5	0	0	-85	21.17
16QAM	5	0	1	-85	21.15					
16QAM	5	0	3	-85	21.09					
Mid Range	20175	1732.5	2175	2132.5	QPSK	1	0	0	-85	22.83
					QPSK	1	5	0	-85	22.81
					QPSK	1	0	1	-85	22.8
					QPSK	1	5	1	-85	22.78
					QPSK	1	0	3	-85	22.79
					QPSK	1	5	3	-85	22.79
					QPSK	3	0	0	-85	22.04
					QPSK	3	3	3	-85	22
					QPSK	6	0	0	-85	21.95
					QPSK	6	0	1	-85	21.94
					QPSK	6	0	3	-85	21.98
					16QAM	1	0	0	-85	22.44
					16QAM	1	5	0	-85	22.88
					16QAM	1	0	1	-85	22.76
					16QAM	1	5	1	-85	22.6
					16QAM	1	0	3	-85	22.58
					16QAM	1	5	3	-85	22.47
					16QAM	3	0	0	-85	21.97
					16QAM	3	3	3	-85	21.96
					16QAM	5	0	0	-85	20.98
16QAM	5	0	1	-85	20.96					
16QAM	5	0	3	-85	21.16					

Test Frequency ID	N <sub>UL</sub>	Frequency of Uplink [MHz]	N <sub>DL</sub>	Frequency of Downlink [MHz]	Test Configuration Initial of Power				EUT	
					Modulation	RB Size	RB Offset	Narrowband Index	Cell power (dBm/15kHz)	power (dBm)
High Range	20375	1752.5	2375	2152.5	QPSK	1	0	0	-85	22.69
					QPSK	1	5	0	-85	22.72
					QPSK	1	0	1	-85	22.7
					QPSK	1	5	1	-85	22.68
					QPSK	1	0	3	-85	22.71
					QPSK	1	5	3	-85	22.67
					QPSK	3	0	0	-85	21.88
					QPSK	3	3	3	-85	21.79
					QPSK	6	0	0	-85	21.82
					QPSK	6	0	1	-85	21.81
					QPSK	6	0	3	-85	21.75
					16QAM	1	0	0	-85	22.95
					16QAM	1	5	0	-85	23.01
					16QAM	1	0	1	-85	23.12
					16QAM	1	5	1	-85	22.92
					16QAM	1	0	3	-85	22.95
					16QAM	1	5	3	-85	22.97
					16QAM	3	0	0	-85	21.88
16QAM	3	3	3	-85	21.89					
16QAM	5	0	0	-85	20.93					
16QAM	5	0	1	-85	20.94					
16QAM	5	0	3	-85	20.95					

BW (MHz): 10										
Test Frequency ID	N <sub>UL</sub>	Frequency of Uplink [MHz]	N <sub>DL</sub>	Frequency of Downlink [MHz]	Test Configuration Initial of Power				EUT	
					Modulation	RB Size	RB Offset	Narrowband Index	Cell power (dBm/15kHz)	power (dBm)
Low Range	20000	1715	2000	2115	QPSK	1	0	0	-85	22.84
					QPSK	1	5	0	-85	22.85
					QPSK	1	0	3	-85	22.83
					QPSK	1	5	3	-85	22.84
					QPSK	1	0	7	-85	22.82
					QPSK	1	5	7	-85	22.81
					QPSK	4	0	0	-85	22.78
					QPSK	4	2	7	-85	22.77
					QPSK	6	0	0	-85	22.03
					QPSK	6	0	7	-85	21.97
					16QAM	1	0	0	-85	22.95
					16QAM	1	5	0	-85	22.51
					16QAM	1	0	3	-85	22.67
					16QAM	1	5	3	-85	22.57
					16QAM	1	0	7	-85	22.49
					16QAM	1	5	7	-85	22.67
					16QAM	4	2	0	-85	22.31
					16QAM	4	2	7	-85	22.05
16QAM	5	0	0	-85	22.01					
16QAM	5	0	7	-85	21.83					
Mid Range	20175	1732.5	2175	2132.5	QPSK	1	0	0	-85	22.87
					QPSK	1	5	0	-85	22.86
					QPSK	1	0	3	-85	22.84
					QPSK	1	5	3	-85	22.83
					QPSK	1	0	7	-85	22.82
					QPSK	1	5	7	-85	22.81
					QPSK	4	0	0	-85	22.81
					QPSK	4	2	7	-85	22.79
					QPSK	6	0	0	-85	21.97
					QPSK	6	0	7	-85	21.97
					16QAM	1	0	0	-85	22.52
					16QAM	1	5	0	-85	22.64
					16QAM	1	0	3	-85	22.49
					16QAM	1	5	3	-85	22.64
					16QAM	1	0	7	-85	22.54
					16QAM	1	5	7	-85	22.71
					16QAM	4	2	0	-85	22.01
					16QAM	4	2	7	-85	22.02
16QAM	5	0	0	-85	22.05					
16QAM	5	0	7	-85	21.81					
High Range	20350	1750	2350	2150	QPSK	1	0	0	-85	22.66
					QPSK	1	5	0	-85	22.59
					QPSK	1	5	7	-85	22.6
					QPSK	1	0	3	-85	22.64
					QPSK	1	5	3	-85	22.63
					QPSK	1	0	7	-85	22.61
					QPSK	4	0	0	-85	22.54
					QPSK	4	2	7	-85	22.53
					QPSK	6	0	0	-85	21.74
					QPSK	6	0	7	-85	21.73
					16QAM	1	0	0	-85	22.67
					16QAM	1	5	0	-85	22.51
					16QAM	1	0	3	-85	22.49
					16QAM	1	5	3	-85	22.72
					16QAM	1	0	7	-85	22.69
					16QAM	1	5	7	-85	22.41
					16QAM	4	2	0	-85	21.84
					16QAM	4	2	7	-85	22.01
16QAM	5	0	0	-85	21.95					
16QAM	5	0	7	-85	21.76					

BW (MHz): 15										
Test Frequency ID	N <sub>UL</sub>	Frequency of Uplink [MHz]	N <sub>DL</sub>	Frequency of Downlink [MHz]	Test Configuration Initial of Power				EUT	
					Modulation	RB Size	RB Offset	Narrowband Index	Cell power (dBm/15kHz)	power (dBm)
Low Range	20025	1717.5	2025	2117.5	QPSK	1	0	0	-85	22.82
					QPSK	1	5	0	-85	22.88
					QPSK	1	0	5	-85	22.86
					QPSK	1	5	5	-85	22.85
					QPSK	1	0	11	-85	22.81
					QPSK	1	5	11	-85	22.72
					QPSK	3	0	0	-85	22.87
					QPSK	3	3	11	-85	22.79
					QPSK	6	0	0	-85	22.87
					QPSK	6	0	11	-85	22.77
					16QAM	1	0	0	-85	22.86
					16QAM	1	5	0	-85	22.73
					16QAM	1	0	5	-85	23.01
					16QAM	1	5	5	-85	22.74
					16QAM	1	0	11	-85	22.61
					16QAM	1	5	11	-85	22.87
					16QAM	3	0	0	-85	22.68
					16QAM	3	3	11	-85	22.76
16QAM	5	0	0	-85	22.73					
16QAM	5	0	11	-85	22.67					
Mid Range	20175	1732.5	2175	2132.5	QPSK	1	0	0	-85	22.88
					QPSK	1	5	0	-85	22.84
					QPSK	1	0	5	-85	22.82
					QPSK	1	5	5	-85	22.81
					QPSK	1	0	11	-85	22.76
					QPSK	1	5	11	-85	22.73
					QPSK	3	0	0	-85	22.73
					QPSK	3	3	11	-85	22.72
					QPSK	6	0	0	-85	22.76
					QPSK	6	0	11	-85	22.72
					16QAM	1	0	0	-85	22.91
					16QAM	1	5	0	-85	22.92
					16QAM	1	0	5	-85	22.81
					16QAM	1	5	5	-85	22.87
					16QAM	1	0	11	-85	22.84
					16QAM	1	5	11	-85	22.64
					16QAM	3	0	0	-85	22.78
					16QAM	3	3	11	-85	22.73
16QAM	5	0	0	-85	22.76					
16QAM	5	0	11	-85	22.67					
High Range	20325	1747.5	2325	2147.5	QPSK	1	0	0	-85	22.69
					QPSK	1	5	11	-85	22.55
					QPSK	1	0	5	-85	22.68
					QPSK	1	5	5	-85	22.66
					QPSK	1	0	11	-85	22.58
					QPSK	1	5	11	-85	22.56
					QPSK	3	0	0	-85	22.71
					QPSK	3	3	11	-85	22.54
					QPSK	6	0	0	-85	22.64
					QPSK	6	0	11	-85	22.52
					16QAM	1	0	0	-85	22.34
					16QAM	1	5	0	-85	22.31
					16QAM	1	0	5	-85	22.26
					16QAM	1	5	5	-85	22.15
					16QAM	1	0	11	-85	22.18
					16QAM	1	5	11	-85	22.27
					16QAM	3	0	0	-85	22.74
					16QAM	3	3	11	-85	22.37
16QAM	5	0	0	-85	22.55					
16QAM	5	0	11	-85	22.49					

BW (MHz): 20										
Test Frequency ID	N <sub>UL</sub>	Frequency of Uplink [MHz]	N <sub>DL</sub>	Frequency of Downlink [MHz]	Test Configuration Initial of Power				EUT	
					Modulation	RB Size	RB Offset	Narrowband Index	Cell power (dBm/15kHz)	power (dBm)
Low Range	20050	1720	2050	2120	QPSK	1	0	0	-85	22.86
					QPSK	1	5	0	-85	22.84
					QPSK	1	0	7	-85	22.81
					QPSK	1	5	7	-85	22.79
					QPSK	1	0	15	-85	22.75
					QPSK	1	5	15	-85	22.74
					QPSK	3	0	0	-85	22.88
					QPSK	3	3	15	-85	22.71
					QPSK	6	0	0	-85	22.82
					QPSK	6	0	15	-85	22.76
					16QAM	1	0	0	-85	23
					16QAM	1	5	0	-85	22.78
					16QAM	1	0	7	-85	22.47
					16QAM	1	5	7	-85	22.48
					16QAM	1	0	15	-85	22.47
					16QAM	1	5	15	-85	22.48
					16QAM	3	0	0	-85	22.83
					16QAM	3	3	15	-85	22.71
16QAM	5	0	0	-85	22.81					
16QAM	5	0	15	-85	22.66					
Mid Range	20175	1732.5	2175	2132.5	QPSK	1	0	0	-85	22.76
					QPSK	1	5	0	-85	22.76
					QPSK	1	0	7	-85	22.71
					QPSK	1	5	7	-85	22.72
					QPSK	1	0	15	-85	22.65
					QPSK	1	5	15	-85	22.61
					QPSK	3	0	0	-85	22.71
					QPSK	3	3	15	-85	22.62
					QPSK	6	0	0	-85	22.72
					QPSK	6	0	15	-85	22.64
					16QAM	1	0	0	-85	22.62
					16QAM	1	5	0	-85	22.71
					16QAM	1	0	7	-85	22.51
					16QAM	1	5	7	-85	22.59
					16QAM	1	0	15	-85	22.19
					16QAM	1	5	15	-85	22.39
					16QAM	3	0	0	-85	22.62
					16QAM	3	3	15	-85	22.66
16QAM	5	0	0	-85	22.74					
16QAM	5	0	15	-85	22.51					
High Range	20300	1745	2300	2145	QPSK	1	0	0	-85	22.66
					QPSK	1	5	0	-85	22.65
					QPSK	1	0	7	-85	22.68
					QPSK	1	5	7	-85	22.65
					QPSK	1	0	15	-85	22.59
					QPSK	1	5	15	-85	22.58
					QPSK	3	0	0	-85	22.73
					QPSK	3	3	15	-85	22.57
					QPSK	6	0	0	-85	22.72
					QPSK	6	0	15	-85	22.52
					16QAM	1	0	0	-85	22.67
					16QAM	1	5	0	-85	22.36
					16QAM	1	0	7	-85	22.61
					16QAM	1	5	7	-85	22.29
					16QAM	1	0	15	-85	22.24
					16QAM	1	5	15	-85	22.37
					16QAM	3	0	0	-85	22.52
					16QAM	3	3	15	-85	22.48
16QAM	5	0	0	-85	22.51					
16QAM	5	0	15	-85	22.36					



### LTE Band 12

BW (MHz): 5										
Test Frequency ID	N <sub>UL</sub>	Frequency of Uplink [MHz]	N <sub>DL</sub>	Frequency of Downlink [MHz]	Test Configuration Initial of Power				EUT	
					Modulation	RB Size	RB Offset	Narrowband Index	Cell power (dBm/15kHz)	power (dBm)
Low Range	23035	701.5	5035	731.5	QPSK	1	0	0	-85	23.61
					QPSK	1	5	0	-85	23.6
					QPSK	1	0	1	-85	23.54
					QPSK	1	5	1	-85	23.61
					QPSK	1	0	3	-85	23.56
					QPSK	1	5	3	-85	23.64
					QPSK	3	0	0	-85	22.58
					QPSK	3	3	3	-85	22.63
					QPSK	6	0	0	-85	22.59
					QPSK	6	0	1	-85	22.61
					QPSK	6	0	3	-85	22.66
					16QAM	1	0	0	-85	23.8
					16QAM	1	5	0	-85	23.81
					16QAM	1	0	1	-85	23.81
					16QAM	1	5	1	-85	23.81
					16QAM	1	0	3	-85	23.83
					16QAM	1	5	3	-85	23.85
					16QAM	3	0	0	-85	22.76
					16QAM	3	3	3	-85	22.91
					16QAM	5	0	0	-85	21.63
16QAM	5	0	1	-85	21.49					
16QAM	5	0	3	-85	21.52					
Mid Range	23095	707.5	5095	737.5	QPSK	1	0	0	-85	23.64
					QPSK	1	5	0	-85	23.65
					QPSK	1	0	1	-85	23.64
					QPSK	1	5	1	-85	23.66
					QPSK	1	0	3	-85	23.71
					QPSK	1	5	3	-85	23.69
					QPSK	3	0	0	-85	22.62
					QPSK	3	3	3	-85	22.65
					QPSK	6	0	0	-85	22.62
					QPSK	6	0	1	-85	22.63
					QPSK	6	0	3	-85	22.61
					16QAM	1	0	0	-85	23.94
					16QAM	1	5	0	-85	23.93
					16QAM	1	0	1	-85	23.94
					16QAM	1	5	1	-85	23.94
					16QAM	1	0	3	-85	23.97
					16QAM	1	5	3	-85	23.95
					16QAM	3	0	0	-85	22.74
					16QAM	3	3	3	-85	22.77
					16QAM	5	0	0	-85	21.71
16QAM	5	0	1	-85	21.69					
16QAM	5	0	3	-85	21.67					

Test Frequency ID	N <sub>UL</sub>	Frequency of Uplink [MHz]	N <sub>DL</sub>	Frequency of Downlink [MHz]	Test Configuration Initial of Power				EUT	
					Modulation	RB Size	RB Offset	Narrowband Index	Cell power (dBm/15kHz)	power (dBm)
High Range	23155	713.5	5155	743.5	QPSK	1	0	0	-85	23.69
					QPSK	1	5	0	-85	23.68
					QPSK	1	0	1	-85	23.68
					QPSK	1	5	1	-85	23.69
					QPSK	1	0	3	-85	23.68
					QPSK	1	5	3	-85	23.7
					QPSK	3	0	0	-85	22.69
					QPSK	3	3	3	-85	22.66
					QPSK	6	0	0	-85	22.7
					QPSK	6	0	1	-85	22.68
					QPSK	6	0	3	-85	22.71
					16QAM	1	0	0	-85	23.78
					16QAM	1	5	0	-85	23.95
					16QAM	1	0	1	-85	23.84
					16QAM	1	5	1	-85	23.93
					16QAM	1	0	3	-85	23.77
					16QAM	1	5	3	-85	23.78
					16QAM	3	0	0	-85	22.68
16QAM	3	3	3	-85	22.71					
16QAM	5	0	0	-85	21.76					
16QAM	5	0	1	-85	21.76					
16QAM	5	0	3	-85	21.72					

BW (MHz): 10										
Test Frequency ID	N <sub>UL</sub>	Frequency of Uplink [MHz]	N <sub>DL</sub>	Frequency of Downlink [MHz]	Test Configuration Initial of Power				EUT	
					Modulation	RB Size	RB Offset	Narrowband Index	Cell power (dBm/15kHz)	power (dBm)
Low Range	23060	704	5060	734	QPSK	1	0	0	-85	23.62
					QPSK	1	5	0	-85	23.63
					QPSK	1	0	3	-85	23.64
					QPSK	1	5	3	-85	23.65
					QPSK	1	0	7	-85	23.67
					QPSK	1	5	7	-85	23.68
					QPSK	4	0	0	-85	23.54
					QPSK	4	2	7	-85	23.64
					QPSK	6	0	0	-85	22.55
					QPSK	6	0	7	-85	22.69
					16QAM	1	0	0	-85	23.61
					16QAM	1	5	0	-85	23.91
					16QAM	1	0	3	-85	23.83
					16QAM	1	5	3	-85	23.93
					16QAM	1	0	7	-85	23.86
					16QAM	1	5	7	-85	23.97
					16QAM	4	2	0	-85	22.78
					16QAM	4	2	7	-85	22.73
16QAM	5	0	0	-85	22.67					
16QAM	5	0	7	-85	22.75					
Mid Range	23095	707.5	5095	737.5	QPSK	1	0	0	-85	23.67
					QPSK	1	5	0	-85	23.66
					QPSK	1	0	3	-85	23.68
					QPSK	1	5	3	-85	23.69
					QPSK	1	0	7	-85	23.7
					QPSK	1	5	7	-85	23.71
					QPSK	4	0	0	-85	23.67
					QPSK	4	2	7	-85	23.65
					QPSK	6	0	0	-85	22.59
					QPSK	6	0	7	-85	22.69
					16QAM	1	0	0	-85	23.81
					16QAM	1	5	0	-85	23.81
					16QAM	1	0	3	-85	23.75
					16QAM	1	5	3	-85	23.76
					16QAM	1	0	7	-85	23.84
					16QAM	1	5	7	-85	23.98
					16QAM	4	2	0	-85	22.8
					16QAM	4	2	7	-85	23.02
16QAM	5	0	0	-85	22.78					
16QAM	5	0	7	-85	22.76					
High Range	23130	711	5130	741	QPSK	1	0	0	-85	23.7
					QPSK	1	5	0	-85	23.7
					QPSK	1	5	7	-85	23.71
					QPSK	1	0	3	-85	23.7
					QPSK	1	5	3	-85	23.69
					QPSK	1	0	7	-85	23.7
					QPSK	4	0	0	-85	23.58
					QPSK	4	2	7	-85	23.61
					QPSK	6	0	0	-85	22.63
					QPSK	6	0	7	-85	22.66
					16QAM	1	0	0	-85	23.76
					16QAM	1	5	0	-85	23.77
					16QAM	1	0	3	-85	23.78
					16QAM	1	5	3	-85	23.77
					16QAM	1	0	7	-85	23.71
					16QAM	1	5	7	-85	23.82
					16QAM	4	2	0	-85	22.7
					16QAM	4	2	7	-85	22.86
16QAM	5	0	0	-85	22.81					
16QAM	5	0	7	-85	22.84					

### LTE Band 66

BW (MHz): 5										
Test Frequency ID	N <sub>UL</sub>	Frequency of Uplink [MHz]	N <sub>DL</sub>	Frequency of Downlink [MHz]	Test Configuration Initial of Power				EUT	
					Modulation	RB Size	RB Offset	Narrowband Index	Cell power (dBm/15kHz)	power (dBm)
Low Range	131997	1712.5	66461	2112.5	QPSK	1	0	0	-85	23.27
					QPSK	1	5	0	-85	23.28
					QPSK	1	0	1	-85	23.27
					QPSK	1	5	1	-85	23.28
					QPSK	1	0	3	-85	23.26
					QPSK	1	5	3	-85	23.2
					QPSK	3	0	0	-85	22.37
					QPSK	3	3	3	-85	22.39
					QPSK	6	0	0	-85	22.31
					QPSK	6	0	1	-85	22.36
					QPSK	6	0	3	-85	22.38
					16QAM	1	0	0	-85	23.23
					16QAM	1	5	0	-85	23.46
					16QAM	1	0	1	-85	23.47
					16QAM	1	5	1	-85	23.46
					16QAM	1	0	3	-85	23.26
					16QAM	1	5	3	-85	23.27
					16QAM	3	0	0	-85	22.42
					16QAM	3	3	3	-85	22.27
					16QAM	5	0	0	-85	21.45
16QAM	5	0	1	-85	21.43					
16QAM	5	0	3	-85	21.43					
Mid Range	132322	1745	66786	2145	QPSK	1	0	0	-85	23.05
					QPSK	1	5	0	-85	23.04
					QPSK	1	0	1	-85	23.02
					QPSK	1	5	1	-85	23.03
					QPSK	1	0	3	-85	23.01
					QPSK	1	5	3	-85	23.02
					QPSK	3	0	0	-85	22.19
					QPSK	3	3	3	-85	22.18
					QPSK	6	0	0	-85	22.16
					QPSK	6	0	1	-85	22.14
					QPSK	6	0	3	-85	22.16
					16QAM	1	0	0	-85	23.43
					16QAM	1	5	0	-85	23.13
					16QAM	1	0	1	-85	23.41
					16QAM	1	5	1	-85	23.4
					16QAM	1	0	3	-85	23.36
					16QAM	1	5	3	-85	23.37
					16QAM	3	0	0	-85	22.02
					16QAM	3	3	3	-85	22.23
					16QAM	5	0	0	-85	21.34
16QAM	5	0	1	-85	21.45					
16QAM	5	0	3	-85	21.48					

Test Frequency ID	N <sub>UL</sub>	Frequency of Uplink [MHz]	N <sub>DL</sub>	Frequency of Downlink [MHz]	Test Configuration Initial of Power				EUT	
					Modulation	RB Size	RB Offset	Narrowband Index	Cell power (dBm/15kHz)	power (dBm)
High Range	132647	1777.5	67111	2177.5	QPSK	1	0	0	-85	22.24
					QPSK	1	5	0	-85	22.23
					QPSK	1	0	1	-85	22.23
					QPSK	1	5	1	-85	22.21
					QPSK	1	0	3	-85	22.22
					QPSK	1	5	3	-85	22.16
					QPSK	3	0	0	-85	21.51
					QPSK	3	3	3	-85	21.47
					QPSK	6	0	0	-85	21.46
					QPSK	6	0	1	-85	21.44
					QPSK	6	0	3	-85	21.42
					16QAM	1	0	0	-85	22.33
					16QAM	1	5	0	-85	22.32
					16QAM	1	0	1	-85	22.37
					16QAM	1	5	1	-85	22.32
					16QAM	1	0	3	-85	22.31
					16QAM	1	5	3	-85	22.34
					16QAM	3	0	0	-85	21.65
					16QAM	3	3	3	-85	21.63
					16QAM	5	0	0	-85	20.56
16QAM	5	0	1	-85	20.57					
16QAM	5	0	3	-85	20.54					

BW (MHz): 10										
Test Frequency ID	N <sub>UL</sub>	Frequency of Uplink [MHz]	N <sub>DL</sub>	Frequency of Downlink [MHz]	Test Configuration Initial of Power				EUT	
					Modulation	RB Size	RB Offset	Narrowband Index	Cell power (dBm/15kHz)	power (dBm)
Low Range	132022	1715	66486	2115	QPSK	1	0	0	-85	23.14
					QPSK	1	5	0	-85	23.15
					QPSK	1	0	3	-85	23.15
					QPSK	1	5	3	-85	23.14
					QPSK	1	0	7	-85	23.13
					QPSK	1	5	7	-85	23.14
					QPSK	4	0	0	-85	23.11
					QPSK	4	2	7	-85	23.15
					QPSK	6	0	0	-85	22.35
					QPSK	6	0	7	-85	22.35
					16QAM	1	0	0	-85	23.31
					16QAM	1	5	0	-85	23.38
					16QAM	1	0	3	-85	23.04
					16QAM	1	5	3	-85	23.05
					16QAM	1	0	7	-85	23.07
					16QAM	1	5	7	-85	23.06
					16QAM	4	2	0	-85	22.33
					16QAM	4	2	7	-85	22.31
16QAM	5	0	0	-85	22.34					
16QAM	5	0	7	-85	22.23					
Mid Range	132322	1745	66786	2145	QPSK	1	0	0	-85	22.71
					QPSK	1	5	0	-85	22.69
					QPSK	1	0	3	-85	22.67
					QPSK	1	5	3	-85	22.66
					QPSK	1	0	7	-85	22.65
					QPSK	1	5	7	-85	22.63
					QPSK	4	0	0	-85	22.66
					QPSK	4	2	7	-85	22.59
					QPSK	6	0	0	-85	21.87
					QPSK	6	0	7	-85	21.79
					16QAM	1	0	0	-85	22.68
					16QAM	1	5	0	-85	22.68
					16QAM	1	0	3	-85	22.78
					16QAM	1	5	3	-85	21.91
					16QAM	1	0	7	-85	22.56
					16QAM	1	5	7	-85	22.67
					16QAM	4	2	0	-85	22.01
					16QAM	4	2	7	-85	22.02
16QAM	5	0	0	-85	21.97					
16QAM	5	0	7	-85	21.82					
High Range	132622	1775	67086	2175	QPSK	1	0	0	-85	22.29
					QPSK	1	5	0	-85	22.27
					QPSK	1	5	7	-85	22.22
					QPSK	1	0	3	-85	22.26
					QPSK	1	5	3	-85	22.26
					QPSK	1	0	7	-85	22.37
					QPSK	4	0	0	-85	22.32
					QPSK	4	2	7	-85	22.26
					QPSK	6	0	0	-85	21.48
					QPSK	6	0	7	-85	21.44
					16QAM	1	0	0	-85	22.15
					16QAM	1	5	0	-85	22.13
					16QAM	1	0	3	-85	22.14
					16QAM	1	5	3	-85	22.03
					16QAM	1	0	7	-85	22.09
					16QAM	1	5	7	-85	22.03
					16QAM	4	2	0	-85	21.68
					16QAM	4	2	7	-85	21.56
16QAM	5	0	0	-85	21.63					
16QAM	5	0	7	-85	21.43					

BW (MHz): 15										
Test Frequency ID	N <sub>UL</sub>	Frequency of Uplink [MHz]	N <sub>DL</sub>	Frequency of Downlink [MHz]	Test Configuration Initial of Power				EUT	
					Modulation	RB Size	RB Offset	Narrowband Index	Cell power (dBm/15kHz)	power (dBm)
Low Range	132047	1717.5	66511	2117.5	QPSK	1	0	0	-85	22.84
					QPSK	1	5	0	-85	22.89
					QPSK	1	0	5	-85	22.86
					QPSK	1	5	5	-85	22.81
					QPSK	1	0	11	-85	22.82
					QPSK	1	5	11	-85	22.82
					QPSK	3	0	0	-85	22.91
					QPSK	3	3	11	-85	22.89
					QPSK	6	0	0	-85	22.81
					QPSK	6	0	11	-85	22.74
					16QAM	1	0	0	-85	22.91
					16QAM	1	5	0	-85	22.72
					16QAM	1	0	5	-85	22.71
					16QAM	1	5	5	-85	22.69
					16QAM	1	0	11	-85	23.07
					16QAM	1	5	11	-85	23.02
					16QAM	3	0	0	-85	22.87
					16QAM	3	3	11	-85	22.78
16QAM	5	0	0	-85	22.75					
16QAM	5	0	11	-85	22.96					
Mid Range	132322	1745	66786	2145	QPSK	1	0	0	-85	23.09
					QPSK	1	5	0	-85	23.04
					QPSK	1	0	5	-85	23.03
					QPSK	1	5	5	-85	23.02
					QPSK	1	0	11	-85	22.97
					QPSK	1	5	11	-85	22.96
					QPSK	3	0	0	-85	22.95
					QPSK	3	3	11	-85	23.03
					QPSK	6	0	0	-85	23.01
					QPSK	6	0	11	-85	22.89
					16QAM	1	0	0	-85	23.1
					16QAM	1	5	0	-85	22.95
					16QAM	1	0	5	-85	22.97
					16QAM	1	5	5	-85	23.02
					16QAM	1	0	11	-85	22.99
					16QAM	1	5	11	-85	22.85
					16QAM	3	0	0	-85	22.89
					16QAM	3	3	11	-85	22.88
16QAM	5	0	0	-85	23.05					
16QAM	5	0	11	-85	22.97					
High Range	132597	1772.5	67061	2172.5	QPSK	1	0	0	-85	22.33
					QPSK	1	5	11	-85	22.32
					QPSK	1	0	5	-85	22.3
					QPSK	1	5	5	-85	22.29
					QPSK	1	0	11	-85	22.23
					QPSK	1	5	11	-85	22.22
					QPSK	3	0	0	-85	22.41
					QPSK	3	3	11	-85	22.29
					QPSK	6	0	0	-85	22.38
					QPSK	6	0	11	-85	22.31
					16QAM	1	0	0	-85	22.21
					16QAM	1	5	0	-85	22.34
					16QAM	1	0	5	-85	22.35
					16QAM	1	5	5	-85	22.34
					16QAM	1	0	11	-85	22.27
					16QAM	1	5	11	-85	22.23
					16QAM	3	0	0	-85	22.29
					16QAM	3	3	11	-85	22.28
16QAM	5	0	0	-85	22.27					
16QAM	5	0	11	-85	22.28					

BW (MHz): 20										
Test Frequency ID	N <sub>UL</sub>	Frequency of Uplink [MHz]	N <sub>DL</sub>	Frequency of Downlink [MHz]	Test Configuration Initial of Power				EUT	
					Modulation	RB Size	RB Offset	Narrowband Index	Cell power (dBm/15kHz)	power (dBm)
Low Range	132072	1720	66536	2120	QPSK	1	0	0	-85	23.2
					QPSK	1	5	0	-85	23.15
					QPSK	1	0	7	-85	23.11
					QPSK	1	5	7	-85	23.1
					QPSK	1	0	15	-85	23.09
					QPSK	1	5	15	-85	23.12
					QPSK	3	0	0	-85	23.19
					QPSK	3	3	15	-85	23.11
					QPSK	6	0	0	-85	23.17
					QPSK	6	0	15	-85	23.07
					16QAM	1	0	0	-85	23.21
					16QAM	1	5	0	-85	23.07
					16QAM	1	0	7	-85	23.01
					16QAM	1	5	7	-85	22.72
					16QAM	1	0	15	-85	23.11
					16QAM	1	5	15	-85	23.01
					16QAM	3	0	0	-85	23.02
					16QAM	3	3	15	-85	23.04
16QAM	5	0	0	-85	23.07					
16QAM	5	0	15	-85	22.96					
Mid Range	132322	1745	66786	2145	QPSK	1	0	0	-85	23.07
					QPSK	1	5	0	-85	23.04
					QPSK	1	0	7	-85	22.99
					QPSK	1	5	7	-85	23.05
					QPSK	1	0	15	-85	22.91
					QPSK	1	5	15	-85	22.98
					QPSK	3	0	0	-85	23.03
					QPSK	3	3	15	-85	22.92
					QPSK	6	0	0	-85	23.02
					QPSK	6	0	15	-85	22.86
					16QAM	1	0	0	-85	23.02
					16QAM	1	5	0	-85	23.07
					16QAM	1	0	7	-85	22.92
					16QAM	1	5	7	-85	22.94
					16QAM	1	0	15	-85	22.93
					16QAM	1	5	15	-85	22.89
					16QAM	3	0	0	-85	23.02
					16QAM	3	3	15	-85	22.91
16QAM	5	0	0	-85	22.98					
16QAM	5	0	15	-85	22.96					
High Range	132572	1770	67036	2170	QPSK	1	0	0	-85	22.36
					QPSK	1	5	0	-85	22.41
					QPSK	1	0	7	-85	22.31
					QPSK	1	5	7	-85	22.24
					QPSK	1	0	15	-85	22.25
					QPSK	1	5	15	-85	22.17
					QPSK	3	0	0	-85	22.32
					QPSK	3	3	15	-85	22.28
					QPSK	6	0	0	-85	22.42
					QPSK	6	0	15	-85	22.17
					16QAM	1	0	0	-85	22.44
					16QAM	1	5	0	-85	22.43
					16QAM	1	0	7	-85	22.34
					16QAM	1	5	7	-85	22.23
					16QAM	1	0	15	-85	22.27
					16QAM	1	5	15	-85	22.22
					16QAM	3	0	0	-85	22.14
					16QAM	3	3	15	-85	22.13
16QAM	5	0	0	-85	22.45					
16QAM	5	0	15	-85	22.14					



**ERP Power (dBm)**

LTE Band 12							
Channel Bandwidth: 5 MHz / QPSK							
Plane	Channel	Frequency (MHz)	Reading (dBm)	Correction Factor (dB)	ERP (dBm)	ERP (mW)	Polarization (H/V)
X	23035	701.5	-2.01	30.17	26.01	399.02	H
	23095	707.5	-1.91	30.17	26.11	408.32	
	23155	713.5	-1.93	30.18	26.10	407.38	
	23035	701.5	-10.80	31.96	19.01	79.62	V
	23095	707.5	-9.18	31.98	20.65	116.14	
	23155	713.5	-10.51	32.03	19.37	86.50	
Channel Bandwidth: 5 MHz / 16QAM							
X	23035	701.5	-3.03	30.17	24.99	315.50	H
	23095	707.5	-2.93	30.17	25.09	322.85	
	23155	713.5	-2.95	30.18	25.08	322.11	
	23035	701.5	-11.82	31.96	17.99	62.95	V
	23095	707.5	-10.20	31.98	19.63	91.83	
	23155	713.5	-11.53	32.03	18.35	68.39	

Note: ERP (dBm) = Reading (dBm) + Correction Factor (dB) – 2.15

LTE Band 12							
Channel Bandwidth: 10 MHz / QPSK							
Plane	Channel	Frequency (MHz)	Reading (dBm)	Correction Factor (dB)	ERP (dBm)	ERP (mW)	Polarization (H/V)
X	23060	704.0	-2.33	30.17	25.69	370.68	H
	23095	707.5	-2.23	30.17	25.79	379.31	
	23130	711.0	-2.25	30.18	25.78	378.44	
	23060	704.0	-11.12	31.96	18.69	73.96	V
	23095	707.5	-9.50	31.98	20.33	107.89	
	23130	711.0	-10.83	32.03	19.05	80.35	
Channel Bandwidth: 10 MHz / 16QAM							
X	23060	704.0	-3.30	30.17	24.72	296.48	H
	23095	707.5	-3.20	30.17	24.82	303.39	
	23130	711.0	-3.22	30.18	24.81	302.69	
	23060	704.0	-12.09	31.96	17.72	59.16	V
	23095	707.5	-10.47	31.98	19.36	86.30	
	23130	711.0	-11.80	32.03	18.08	64.27	

Note: ERP (dBm) = Reading (dBm) + Correction Factor (dB) – 2.15

**EIRP Power (dBm)**

LTE Band 4							
Channel Bandwidth: 5 MHz / QPSK							
Plane	Channel	Frequency (MHz)	Reading (dBm)	Correction Factor (dB)	EIRP (dBm)	EIRP (mW)	Polarization (H/V)
X	19975	1712.5	-11.28	36.45	25.17	328.85	H
	20175	1732.5	-11.75	36.80	25.05	319.89	
	20375	1752.5	-12.00	36.94	24.94	311.89	
	19975	1712.5	-17.81	37.28	19.47	88.51	V
	20175	1732.5	-18.39	37.63	19.24	83.95	
	20375	1752.5	-18.63	37.64	19.01	79.62	
Channel Bandwidth: 5 MHz / 16QAM							
X	19975	1712.5	-12.29	36.45	24.16	260.62	H
	20175	1732.5	-12.76	36.80	24.04	253.51	
	20375	1752.5	-13.01	36.94	23.93	247.17	
	19975	1712.5	-18.82	37.28	18.46	70.15	V
	20175	1732.5	-19.40	37.63	18.23	66.53	
	20375	1752.5	-19.64	37.64	18.00	63.10	

Note: EIRP (dBm) = Reading (dBm) + Correction Factor (dB)

LTE Band 4							
Channel Bandwidth: 10 MHz / QPSK							
Plane	Channel	Frequency (MHz)	Reading (dBm)	Correction Factor (dB)	EIRP (dBm)	EIRP (mW)	Polarization (H/V)
X	20000	1715.0	-11.71	36.64	24.93	311.17	H
	20175	1732.5	-11.99	36.80	24.81	302.69	
	20350	1750.0	-12.10	36.80	24.70	295.12	
	20000	1715.0	-18.21	37.44	19.23	83.75	V
	20175	1732.5	-18.63	37.63	19.00	79.43	
	20350	1750.0	-18.87	37.64	18.77	75.34	
Channel Bandwidth: 10 MHz / 16QAM							
X	20000	1715.0	-12.70	36.64	23.94	247.74	H
	20175	1732.5	-12.98	36.80	23.82	240.99	
	20350	1750.0	-13.09	36.80	23.71	234.96	
	20000	1715.0	-19.20	37.44	18.24	66.68	V
	20175	1732.5	-19.62	37.63	18.01	63.24	
	20350	1750.0	-19.86	37.64	17.78	59.98	

Note: EIRP (dBm) = Reading (dBm) + Correction Factor (dB)

LTE Band 4							
Channel Bandwidth: 15 MHz / QPSK							
Plane	Channel	Frequency (MHz)	Reading (dBm)	Correction Factor (dB)	EIRP (dBm)	EIRP (mW)	Polarization (H/V)
X	20025	1717.5	-11.74	36.45	24.71	295.80	H
	20175	1732.5	-12.21	36.80	24.59	287.74	
	20325	1747.5	-12.46	36.94	24.48	280.54	
	20025	1717.5	-18.27	37.28	19.01	79.62	V
	20175	1732.5	-18.85	37.63	18.78	75.51	
	20325	1747.5	-19.09	37.64	18.55	71.61	
Channel Bandwidth: 15 MHz / 16QAM							
X	20025	1717.5	-12.76	36.45	23.69	233.88	H
	20175	1732.5	-13.23	36.80	23.57	227.51	
	20325	1747.5	-13.48	36.94	23.46	221.82	
	20025	1717.5	-19.29	37.28	17.99	62.95	V
	20175	1732.5	-19.87	37.63	17.76	59.70	
	20325	1747.5	-20.11	37.64	17.53	56.62	

Note: EIRP (dBm) = Reading (dBm) + Correction Factor (dB)

LTE Band 4							
Channel Bandwidth: 20 MHz / QPSK							
Plane	Channel	Frequency (MHz)	Reading (dBm)	Correction Factor (dB)	EIRP (dBm)	EIRP (mW)	Polarization (H/V)
X	20050	1720.0	-11.97	36.45	24.48	280.54	H
	20175	1732.5	-12.44	36.80	24.36	272.90	
	20300	1745.0	-12.69	36.94	24.25	266.07	
	20050	1720.0	-18.50	37.28	18.78	75.51	V
	20175	1732.5	-19.08	37.63	18.55	71.61	
	20300	1745.0	-19.32	37.64	18.32	67.92	
Channel Bandwidth: 20 MHz / 16QAM							
X	20050	1720.0	-12.96	36.45	23.49	223.36	H
	20175	1732.5	-13.43	36.80	23.37	217.27	
	20300	1745.0	-13.68	36.94	23.26	211.84	
	20050	1720.0	-19.49	37.28	17.79	60.12	V
	20175	1732.5	-20.07	37.63	17.56	57.02	
	20300	1745.0	-20.31	37.64	17.33	54.08	

Note: EIRP (dBm) = Reading (dBm) + Correction Factor (dB)

LTE Band 66							
Channel Bandwidth: 5 MHz / QPSK							
Plane	Channel	Frequency (MHz)	Reading (dBm)	Correction Factor (dB)	EIRP (dBm)	EIRP (mW)	Polarization (H/V)
X	131997	1712.5	-10.70	36.45	25.75	375.84	H
	132322	1745.0	-11.29	36.80	25.51	355.63	
	132647	1777.5	-11.66	36.94	25.28	337.29	
	131997	1712.5	-16.59	37.28	20.69	117.22	V
	132322	1745.0	-17.29	37.63	20.34	108.14	
	132647	1777.5	-17.63	37.64	20.01	100.23	
Channel Bandwidth: 5 MHz / 16QAM							
X	131997	1712.5	-11.71	36.45	24.74	297.85	H
	132322	1745.0	-12.30	36.80	24.50	281.84	
	132647	1777.5	-12.67	36.94	24.27	267.30	
	131997	1712.5	-17.60	37.28	19.68	92.90	V
	132322	1745.0	-18.30	37.63	19.33	85.70	
	132647	1777.5	-18.64	37.64	19.00	79.43	

Note: EIRP (dBm) = Reading (dBm) + Correction Factor (dB)

LTE Band 66							
Channel Bandwidth: 10 MHz / QPSK							
Plane	Channel	Frequency (MHz)	Reading (dBm)	Correction Factor (dB)	EIRP (dBm)	EIRP (mW)	Polarization (H/V)
X	132022	1715.0	-11.14	36.64	25.50	354.81	H
	132322	1745.0	-11.54	36.80	25.26	335.74	
	132622	1775.0	-11.77	36.80	25.03	318.42	
	132022	1715.0	-17.00	37.44	20.44	110.66	V
	132322	1745.0	-17.54	37.63	20.09	102.09	
	132622	1775.0	-17.88	37.64	19.76	94.62	
Channel Bandwidth: 10 MHz / 16QAM							
X	132022	1715.0	-12.12	36.64	24.52	283.14	H
	132322	1745.0	-12.52	36.80	24.28	267.92	
	132622	1775.0	-12.75	36.80	24.05	254.10	
	132022	1715.0	-17.98	37.44	19.46	88.31	V
	132322	1745.0	-18.52	37.63	19.11	81.47	
	132622	1775.0	-18.86	37.64	18.78	75.51	

Note: EIRP (dBm) = Reading (dBm) + Correction Factor (dB)

LTE Band 66							
Channel Bandwidth: 15 MHz / QPSK							
Plane	Channel	Frequency (MHz)	Reading (dBm)	Correction Factor (dB)	EIRP (dBm)	EIRP (mW)	Polarization (H/V)
X	132047	1717.5	-11.18	36.45	25.27	336.51	H
	132322	1745.0	-11.77	36.80	25.03	318.42	
	132597	1772.5	-12.14	36.94	24.80	302.00	
	132047	1717.5	-17.07	37.28	20.21	104.95	V
	132322	1745.0	-17.77	37.63	19.86	96.83	
	132597	1772.5	-18.11	37.64	19.53	89.74	
Channel Bandwidth: 15 MHz / 16QAM							
X	132047	1717.5	-12.17	36.45	24.28	267.92	H
	132322	1745.0	-12.76	36.80	24.04	253.51	
	132597	1772.5	-13.13	36.94	23.81	240.44	
	132047	1717.5	-18.06	37.28	19.22	83.56	V
	132322	1745.0	-18.76	37.63	18.87	77.09	
	132597	1772.5	-19.10	37.64	18.54	71.45	

Note: EIRP (dBm) = Reading (dBm) + Correction Factor (dB)

LTE Band 66							
Channel Bandwidth: 20 MHz / QPSK							
Plane	Channel	Frequency (MHz)	Reading (dBm)	Correction Factor (dB)	EIRP (dBm)	EIRP (mW)	Polarization (H/V)
X	132072	1720.0	-11.40	36.45	25.05	319.89	H
	132322	1745.0	-11.99	36.80	24.81	302.69	
	132572	1770.0	-12.36	36.94	24.58	287.08	
	132072	1720.0	-17.29	37.28	19.99	99.77	V
	132322	1745.0	-17.99	37.63	19.64	92.04	
	132572	1770.0	-18.33	37.64	19.31	85.31	
Channel Bandwidth: 20 MHz / 16QAM							
X	132072	1720.0	-12.37	36.45	24.08	255.86	H
	132322	1745.0	-12.96	36.80	23.84	242.10	
	132572	1770.0	-13.33	36.94	23.61	229.61	
	132072	1720.0	-18.26	37.28	19.02	79.80	V
	132322	1745.0	-18.96	37.63	18.67	73.62	
	132572	1770.0	-19.30	37.64	18.34	68.23	

Note: EIRP (dBm) = Reading (dBm) + Correction Factor (dB)

## 4.2 Modulation Characteristics Measurement

### 4.2.1 Limits of Modulation Characteristics

N/A

### 4.2.2 Test Setup

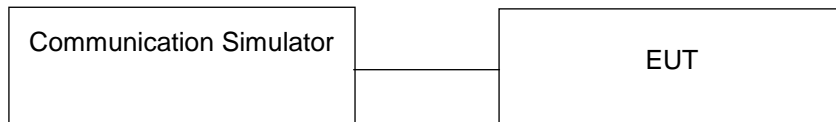

### 4.2.3 Test Procedure

Connect the EUT to Communication Simulator via the antenna connector. The frequency band is set as EUT supported Modulation and Channels, the EUT output is matched with 50 ohm load, the waveform quality and constellation of the EUT was tested.

### 4.2.4 Test Results

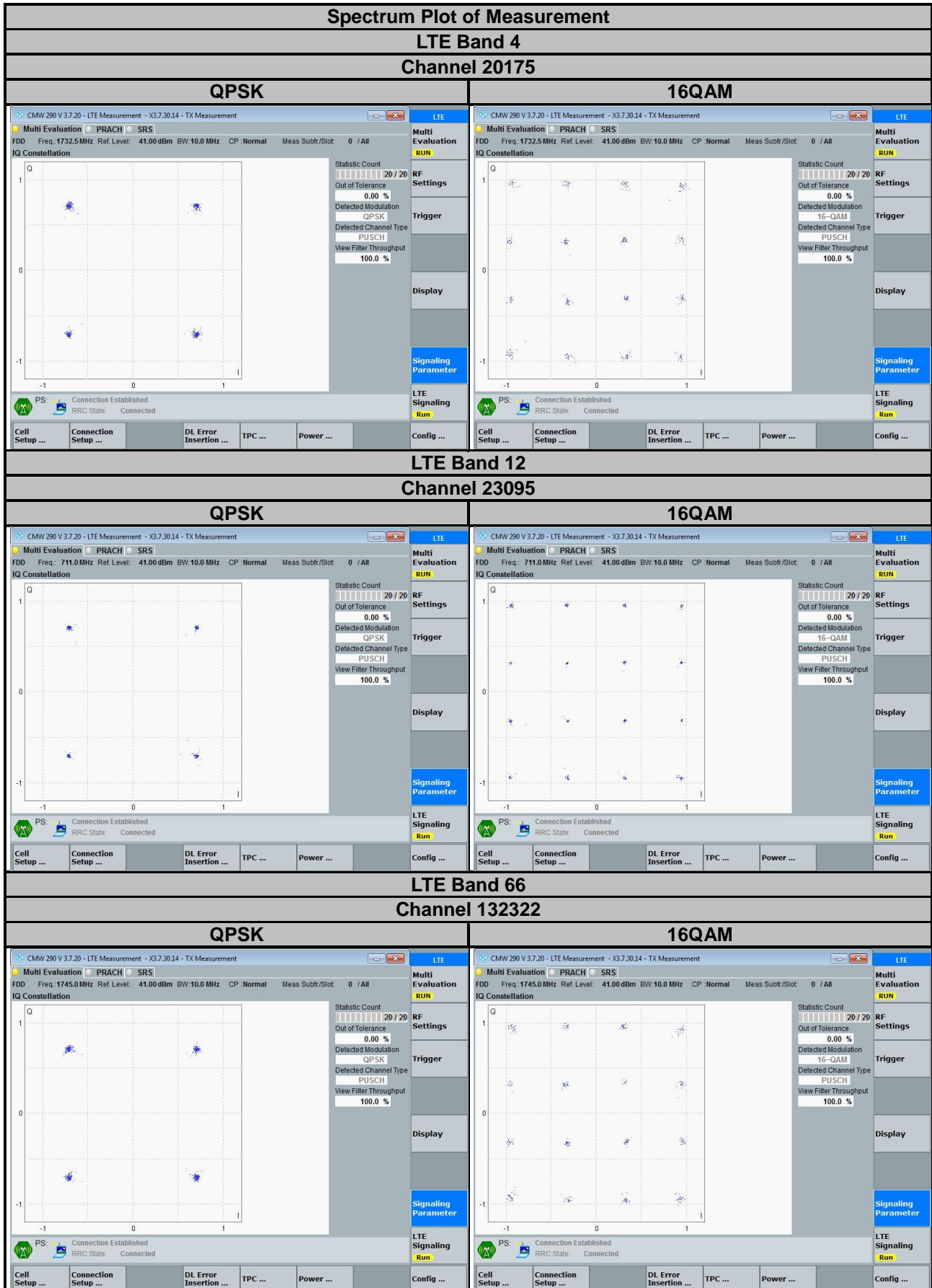

### 4.3 Frequency Stability Measurement

#### 4.3.1 Limits of Frequency Stability Measurement

The frequency stability shall be sufficient to ensure that the fundamental emissions stay within the authorized bands of operation.

#### 4.3.2 Test Procedure

- Device is placed at the oven room. The oven room could control the temperatures and humidity. Power warm up is at least 15 min and power applied should perform before recording frequency error.
- EUT is connected the external power supply to control the DC input power. The test voltage range is from minimum to maximum working voltage. Each step shall be record the frequency error rate.
- The temperature range step is 10 degrees in this test items. All temperature levels shall be hold the  $\pm 0.5$  °C during the measurement testing. The each temperature step shall be at least 0.5 hours, consider the EUT could be test under the stability condition.

**Note:** The frequency error was recorded frequency error from the communication simulator.

#### 4.3.3 Test Setup

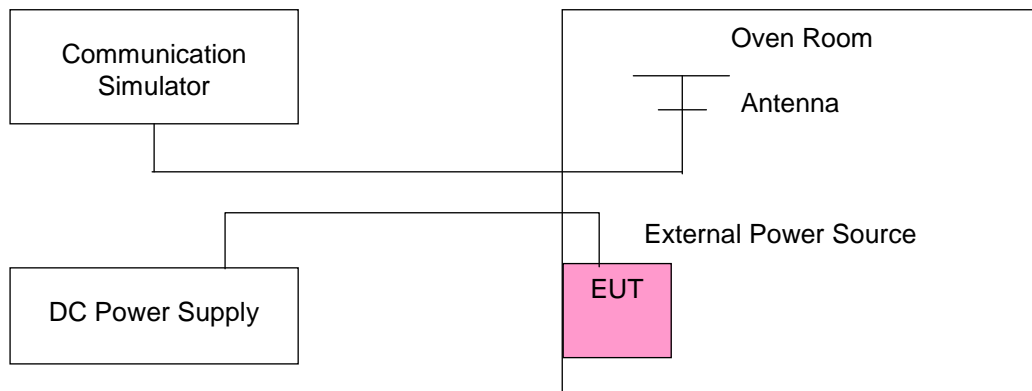



#### 4.3.4 Test Results

##### Frequency Error vs. Voltage

Voltage (Volts)	LTE Band 4				Limit (ppm)
	Channel Bandwidth: 5 MHz				
	Low Channel		High Channel		
	Frequency (MHz)	Frequency Error (ppm)	Frequency (MHz)	Frequency Error (ppm)	
3.8	1712.500004	0.002	1752.500004	0.002	2.5
3.1	1712.500004	0.002	1752.500004	0.002	2.5
4.5	1712.500003	0.002	1752.500003	0.002	2.5

**Note:** The applicant defined the normal working voltage of the battery is from 3.1 Vdc to 4.5 Vdc.

##### Frequency Error vs. Temperature

Temp. (°C)	LTE Band 4				Limit (ppm)
	Channel Bandwidth: 5 MHz				
	Low Channel		High Channel		
	Frequency (MHz)	Frequency Error (ppm)	Frequency (MHz)	Frequency Error (ppm)	
-30	1712.500004	0.002	1752.500002	0.001	2.5
-20	1712.500003	0.002	1752.500002	0.001	2.5
-10	1712.500004	0.002	1752.500004	0.002	2.5
0	1712.500001	0.001	1752.500001	0.001	2.5
10	1712.500002	0.001	1752.500003	0.002	2.5
20	1712.499998	-0.001	1752.499998	-0.001	2.5
30	1712.499997	-0.002	1752.499997	-0.002	2.5
40	1712.499997	-0.002	1752.499997	-0.002	2.5
50	1712.499997	-0.002	1752.499996	-0.002	2.5
60	1712.499998	-0.001	1752.499998	-0.001	2.5
70	1712.499998	-0.001	1752.499996	-0.002	2.5
80	1712.499998	-0.001	1752.499996	-0.002	2.5
85	1712.499997	-0.002	1752.499997	-0.002	2.5

## Frequency Error vs. Voltage

Voltage (Volts)	LTE Band 4				Limit (ppm)
	Channel Bandwidth: 10 MHz				
	Low Channel		High Channel		
	Frequency (MHz)	Frequency Error (ppm)	Frequency (MHz)	Frequency Error (ppm)	
3.8	1715.000001	0.001	1750.000001	0.001	2.5
3.1	1715.000003	0.002	1750.000003	0.002	2.5
4.5	1715.000002	0.001	1750.000004	0.002	2.5

**Note:** The applicant defined the normal working voltage of the battery is from 3.1 Vdc to 4.5 Vdc.

## Frequency Error vs. Temperature

Temp. (°C)	LTE Band 4				Limit (ppm)
	Channel Bandwidth: 10 MHz				
	Low Channel		High Channel		
	Frequency (MHz)	Frequency Error (ppm)	Frequency (MHz)	Frequency Error (ppm)	
-30	1715.000003	0.002	1750.000003	0.002	2.5
-20	1715.000003	0.002	1750.000001	0.001	2.5
-10	1715.000002	0.001	1750.000002	0.001	2.5
0	1715.000001	0.001	1750.000004	0.002	2.5
10	1715.000003	0.002	1750.000003	0.001	2.5
20	1714.999997	-0.002	1749.999997	-0.002	2.5
30	1714.999997	-0.002	1749.999997	-0.002	2.5
40	1714.999999	-0.001	1749.999998	-0.001	2.5
50	1714.999999	-0.001	1749.999999	-0.001	2.5
60	1714.999999	-0.001	1749.999998	-0.001	2.5
70	1714.999997	-0.002	1749.999997	-0.002	2.5
80	1714.999997	-0.002	1749.999999	-0.001	2.5
85	1714.999998	-0.001	1749.999996	-0.002	2.5

## Frequency Error vs. Voltage

Voltage (Volts)	LTE Band 4				Limit (ppm)
	Channel Bandwidth: 15 MHz				
	Low Channel		High Channel		
	Frequency (MHz)	Frequency Error (ppm)	Frequency (MHz)	Frequency Error (ppm)	
3.8	1717.500004	0.002	1747.500003	0.002	2.5
3.1	1717.500001	0.001	1747.500003	0.002	2.5
4.5	1717.500004	0.002	1747.500002	0.001	2.5

**Note:** The applicant defined the normal working voltage of the battery is from 3.1 Vdc to 4.5 Vdc.

## Frequency Error vs. Temperature

Temp. (°C)	LTE Band 4				Limit (ppm)
	Channel Bandwidth: 15 MHz				
	Low Channel		High Channel		
	Frequency (MHz)	Frequency Error (ppm)	Frequency (MHz)	Frequency Error (ppm)	
-30	1717.500002	0.001	1747.500003	0.001	2.5
-20	1717.500001	0.001	1747.500001	0.001	2.5
-10	1717.500003	0.002	1747.500001	0.001	2.5
0	1717.500003	0.002	1747.500002	0.001	2.5
10	1717.500003	0.002	1747.500004	0.002	2.5
20	1717.499998	-0.001	1747.499999	-0.001	2.5
30	1717.499998	-0.001	1747.499997	-0.002	2.5
40	1717.499998	-0.001	1747.499999	-0.001	2.5
50	1717.499997	-0.002	1747.499998	-0.001	2.5
60	1717.499997	-0.002	1747.499997	-0.002	2.5
70	1717.499998	-0.001	1747.499998	-0.001	2.5
80	1717.499998	-0.001	1747.499998	-0.001	2.5
85	1717.499997	-0.002	1747.499998	-0.001	2.5

Frequency Error vs. Voltage

Voltage (Volts)	LTE Band 4				Limit (ppm)
	Channel Bandwidth: 20 MHz				
	Low Channel		High Channel		
	Frequency (MHz)	Frequency Error (ppm)	Frequency (MHz)	Frequency Error (ppm)	
3.8	1720.000001	0.001	1745.000002	0.001	2.5
3.1	1720.000002	0.001	1745.000003	0.002	2.5
4.5	1720.000004	0.002	1745.000004	0.002	2.5

**Note:** The applicant defined the normal working voltage of the battery is from 3.1 Vdc to 4.5 Vdc.

Frequency Error vs. Temperature

Temp. (°C)	LTE Band 4				Limit (ppm)
	Channel Bandwidth: 20 MHz				
	Low Channel		High Channel		
	Frequency (MHz)	Frequency Error (ppm)	Frequency (MHz)	Frequency Error (ppm)	
-30	1720.000003	0.002	1745.000003	0.001	2.5
-20	1720.000003	0.002	1745.000002	0.001	2.5
-10	1720.000001	0.001	1745.000003	0.002	2.5
0	1720.000004	0.002	1745.000003	0.001	2.5
10	1720.000002	0.001	1745.000004	0.002	2.5
20	1719.999998	-0.001	1744.999997	-0.002	2.5
30	1719.999996	-0.002	1744.999999	-0.001	2.5
40	1719.999998	-0.001	1744.999998	-0.001	2.5
50	1719.999998	-0.001	1744.999997	-0.002	2.5
60	1719.999998	-0.001	1744.999997	-0.002	2.5
70	1719.999997	-0.002	1744.999998	-0.001	2.5
80	1719.999997	-0.002	1744.999999	-0.001	2.5
85	1719.999999	-0.001	1744.999998	-0.001	2.5

## Frequency Error vs. Voltage

Voltage (Volts)	LTE Band 12				Limit (ppm)
	Channel Bandwidth: 5 MHz				
	Low Channel		High Channel		
	Frequency (MHz)	Frequency Error (ppm)	Frequency (MHz)	Frequency Error (ppm)	
3.8	701.500003	0.004	713.500002	0.003	2.5
3.1	701.500004	0.005	713.500002	0.003	2.5
4.5	701.500003	0.004	713.500003	0.004	2.5

**Note:** The applicant defined the normal working voltage of the battery is from 3.1 Vdc to 4.5 Vdc.

## Frequency Error vs. Temperature

Temp. (°C)	LTE Band 12				Limit (ppm)
	Channel Bandwidth: 5 MHz				
	Low Channel		High Channel		
	Frequency (MHz)	Frequency Error (ppm)	Frequency (MHz)	Frequency Error (ppm)	
-30	701.500003	0.004	713.500001	0.002	2.5
-20	701.500001	0.002	713.500002	0.003	2.5
-10	701.500002	0.002	713.500004	0.005	2.5
0	701.500003	0.004	713.500004	0.005	2.5
10	701.500003	0.004	713.500002	0.003	2.5
20	701.499998	-0.002	713.499997	-0.004	2.5
30	701.499996	-0.005	713.499998	-0.003	2.5
40	701.499997	-0.004	713.499999	-0.002	2.5
50	701.499998	-0.003	713.499998	-0.003	2.5
60	701.499998	-0.003	713.499998	-0.003	2.5
70	701.499999	-0.002	713.499997	-0.004	2.5
80	701.499998	-0.003	713.499997	-0.005	2.5
85	701.499999	-0.002	713.499997	-0.005	2.5

Frequency Error vs. Voltage

Voltage (Volts)	LTE Band 12				Limit (ppm)
	Channel Bandwidth: 10 MHz				
	Low Channel		High Channel		
	Frequency (MHz)	Frequency Error (ppm)	Frequency (MHz)	Frequency Error (ppm)	
3.8	704.000003	0.004	711.000001	0.002	2.5
3.1	704.000004	0.005	711.000002	0.003	2.5
4.5	704.000002	0.002	711.000003	0.004	2.5

**Note:** The applicant defined the normal working voltage of the battery is from 3.1 Vdc to 4.5 Vdc.

Frequency Error vs. Temperature

Temp. (°C)	LTE Band 12				Limit (ppm)
	Channel Bandwidth: 10 MHz				
	Low Channel		High Channel		
	Frequency (MHz)	Frequency Error (ppm)	Frequency (MHz)	Frequency Error (ppm)	
-30	704.000003	0.004	711.000003	0.004	2.5
-20	704.000003	0.004	711.000001	0.002	2.5
-10	704.000003	0.004	711.000003	0.004	2.5
0	704.000002	0.003	711.000004	0.005	2.5
10	704.000002	0.003	711.000003	0.004	2.5
20	703.999997	-0.004	710.999996	-0.005	2.5
30	703.999998	-0.003	710.999997	-0.005	2.5
40	703.999996	-0.006	710.999997	-0.004	2.5
50	703.999999	-0.002	710.999999	-0.002	2.5
60	703.999998	-0.004	710.999997	-0.005	2.5
70	703.999999	-0.002	710.999998	-0.003	2.5
80	703.999997	-0.004	710.999996	-0.006	2.5
85	703.999998	-0.003	710.999998	-0.003	2.5

## Frequency Error vs. Voltage

Voltage (Volts)	LTE Band 66				Limit (ppm)
	Channel Bandwidth: 5 MHz				
	Low Channel		High Channel		
	Frequency (MHz)	Frequency Error (ppm)	Frequency (MHz)	Frequency Error (ppm)	
3.8	1712.500004	0.002	1777.500003	0.002	2.5
3.1	1712.500004	0.002	1777.500002	0.001	2.5
4.5	1712.500003	0.002	1777.500003	0.001	2.5

**Note:** The applicant defined the normal working voltage of the battery is from 3.1 Vdc to 4.5 Vdc.

## Frequency Error vs. Temperature

Temp. (°C)	LTE Band 66				Limit (ppm)
	Channel Bandwidth: 5 MHz				
	Low Channel		High Channel		
	Frequency (MHz)	Frequency Error (ppm)	Frequency (MHz)	Frequency Error (ppm)	
-30	1712.500002	0.001	1777.500001	0.001	2.5
-20	1712.500002	0.001	1777.500003	0.002	2.5
-10	1712.500003	0.002	1777.500004	0.002	2.5
0	1712.500004	0.002	1777.500004	0.002	2.5
10	1712.500002	0.001	1777.500004	0.002	2.5
20	1712.499998	-0.001	1777.499997	-0.002	2.5
30	1712.499998	-0.001	1777.499998	-0.001	2.5
40	1712.499999	-0.001	1777.499997	-0.002	2.5
50	1712.499997	-0.002	1777.499996	-0.002	2.5
60	1712.499998	-0.001	1777.499999	-0.001	2.5
70	1712.499997	-0.002	1777.499998	-0.001	2.5
80	1712.499998	-0.001	1777.499997	-0.002	2.5
85	1712.499999	-0.001	1777.499997	-0.002	2.5

## Frequency Error vs. Voltage

Voltage (Volts)	LTE Band 66				Limit (ppm)
	Channel Bandwidth: 10 MHz				
	Low Channel		High Channel		
	Frequency (MHz)	Frequency Error (ppm)	Frequency (MHz)	Frequency Error (ppm)	
3.8	1715.000003	0.002	1775.000001	0.001	2.5
3.1	1715.000002	0.001	1775.000002	0.001	2.5
4.5	1715.000003	0.001	1775.000003	0.002	2.5

**Note:** The applicant defined the normal working voltage of the battery is from 3.1 Vdc to 4.5 Vdc.

## Frequency Error vs. Temperature

Temp. (°C)	LTE Band 66				Limit (ppm)
	Channel Bandwidth: 10 MHz				
	Low Channel		High Channel		
	Frequency (MHz)	Frequency Error (ppm)	Frequency (MHz)	Frequency Error (ppm)	
-30	1715.000001	0.001	1775.000003	0.002	2.5
-20	1715.000002	0.001	1775.000002	0.001	2.5
-10	1715.000002	0.001	1775.000002	0.001	2.5
0	1715.000003	0.002	1775.000001	0.001	2.5
10	1715.000004	0.002	1775.000004	0.002	2.5
20	1714.999997	-0.002	1774.999998	-0.001	2.5
30	1714.999999	-0.001	1774.999997	-0.002	2.5
40	1714.999999	-0.001	1774.999996	-0.002	2.5
50	1714.999998	-0.001	1774.999999	-0.001	2.5
60	1714.999997	-0.002	1774.999998	-0.001	2.5
70	1714.999997	-0.002	1774.999996	-0.002	2.5
80	1714.999998	-0.001	1774.999996	-0.002	2.5
85	1714.999998	-0.001	1774.999997	-0.002	2.5



Frequency Error vs. Voltage

Voltage (Volts)	LTE Band 66				Limit (ppm)
	Channel Bandwidth: 15 MHz				
	Low Channel		High Channel		
	Frequency (MHz)	Frequency Error (ppm)	Frequency (MHz)	Frequency Error (ppm)	
3.8	1717.500004	0.002	1772.500004	0.002	2.5
3.1	1717.500003	0.002	1772.500004	0.002	2.5
4.5	1717.500002	0.001	1772.500004	0.002	2.5

**Note:** The applicant defined the normal working voltage of the battery is from 3.1 Vdc to 4.5 Vdc.

Frequency Error vs. Temperature

Temp. (°C)	LTE Band 66				Limit (ppm)
	Channel Bandwidth: 15 MHz				
	Low Channel		High Channel		
	Frequency (MHz)	Frequency Error (ppm)	Frequency (MHz)	Frequency Error (ppm)	
-30	1717.500004	0.002	1772.500001	0.001	2.5
-20	1717.500003	0.002	1772.500001	0.001	2.5
-10	1717.500003	0.002	1772.500002	0.001	2.5
0	1717.500004	0.002	1772.500002	0.001	2.5
10	1717.500003	0.002	1772.500002	0.001	2.5
20	1717.499997	-0.002	1772.499999	-0.001	2.5
30	1717.499998	-0.001	1772.499996	-0.002	2.5
40	1717.499999	-0.001	1772.499998	-0.001	2.5
50	1717.499998	-0.001	1772.499999	-0.001	2.5
60	1717.499998	-0.001	1772.499999	-0.001	2.5
70	1717.499998	-0.001	1772.499997	-0.002	2.5
80	1717.499998	-0.001	1772.499997	-0.002	2.5
85	1717.499996	-0.002	1772.499996	-0.002	2.5

## Frequency Error vs. Voltage

Voltage (Volts)	LTE Band 66				Limit (ppm)
	Channel Bandwidth: 20 MHz				
	Low Channel		High Channel		
	Frequency (MHz)	Frequency Error (ppm)	Frequency (MHz)	Frequency Error (ppm)	
3.8	1720.000004	0.002	1770.000003	0.002	2.5
3.1	1720.000003	0.002	1770.000003	0.002	2.5
4.5	1720.000001	0.001	1770.000003	0.002	2.5

**Note:** The applicant defined the normal working voltage of the battery is from 3.1 Vdc to 4.5 Vdc.

## Frequency Error vs. Temperature

Temp. (°C)	LTE Band 66				Limit (ppm)
	Channel Bandwidth: 20 MHz				
	Low Channel		High Channel		
	Frequency (MHz)	Frequency Error (ppm)	Frequency (MHz)	Frequency Error (ppm)	
-30	1720.000001	0.001	1770.000002	0.001	2.5
-20	1720.000001	0.001	1770.000002	0.001	2.5
-10	1720.000001	0.001	1770.000002	0.001	2.5
0	1720.000003	0.002	1770.000003	0.002	2.5
10	1720.000003	0.002	1770.000003	0.002	2.5
20	1719.999998	-0.001	1769.999999	-0.001	2.5
30	1719.999996	-0.002	1769.999998	-0.001	2.5
40	1719.999997	-0.002	1769.999997	-0.002	2.5
50	1719.999998	-0.001	1769.999998	-0.001	2.5
60	1719.999997	-0.002	1769.999997	-0.002	2.5
70	1719.999998	-0.001	1769.999996	-0.002	2.5
80	1719.999999	-0.001	1769.999997	-0.002	2.5
85	1719.999998	-0.001	1769.999999	-0.001	2.5

#### 4.4 Occupied Bandwidth Measurement

##### 4.4.1 Limits of Occupied Bandwidth Measurement

The width of a frequency band such that, below the lower and above the upper frequency limits, the mean powers emitted are each equal to a specified percentage 0.5 % of the total mean power of a given emission.

##### 4.4.2 Test Procedure

- The conducted occupied bandwidth used the power splitter via EUT RF power connector between simulation base station and spectrum analyzer.
- Use OBW measurement function of Spectrum analyzer to measure 99 % occupied bandwidth.

##### 4.4.3 Test Setup

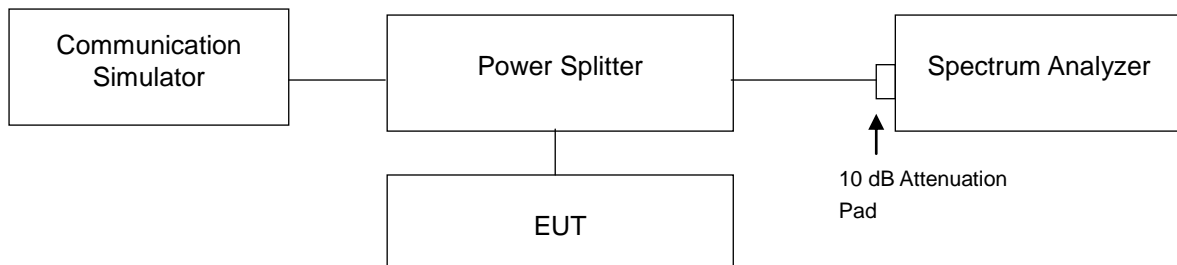

4.4.4 Test Result

LTE Band 4							
Channel Bandwidth: 5 MHz				Channel Bandwidth: 10 MHz			
Channel	Frequency (MHz)	99 % Occupied Bandwidth (MHz)		Channel	Frequency (MHz)	99 % Occupied Bandwidth (MHz)	
		QPSK	16QAM			QPSK	16QAM
19975	1712.5	1.1016	0.9255	20000	1715.0	1.0902	0.9190
20175	1732.5	1.0888	0.9245	20175	1732.5	1.0924	0.9171
20375	1752.5	1.0844	0.9153	20350	1750.0	1.0921	0.9179

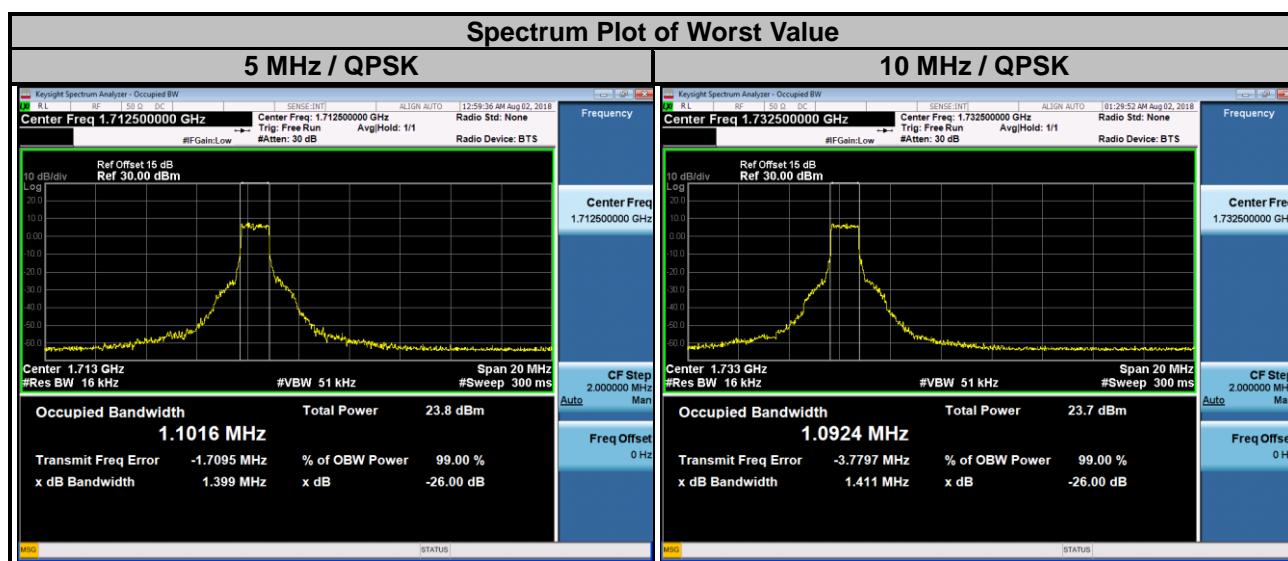

### LTE Band 4

Channel Bandwidth: 15 MHz				Channel Bandwidth: 20 MHz			
Channel	Frequency (MHz)	99 % Occupied Bandwidth (MHz)		Channel	Frequency (MHz)	99 % Occupied Bandwidth (MHz)	
		QPSK	16QAM			QPSK	16QAM
20025	1717.5	1.0802	0.9284	20050	1720.0	1.0912	0.9219
20175	1732.5	1.0972	0.9237	20175	1732.5	1.0966	0.9170
20325	1747.5	1.0850	0.9234	20300	1745.0	1.0937	0.9208

### Spectrum Plot of Worst Value

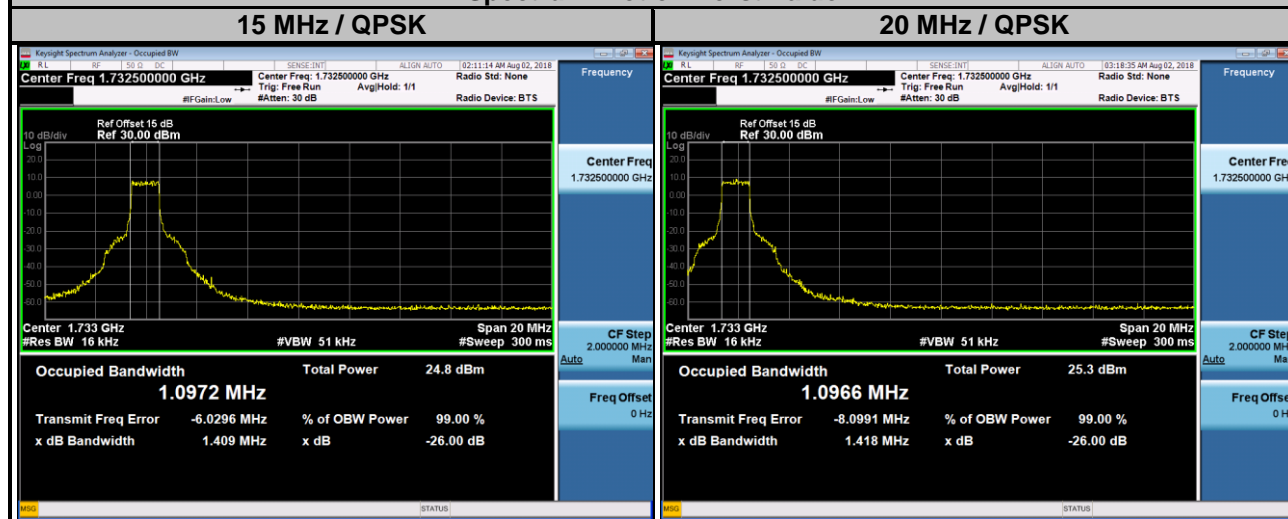

### LTE Band 12

Channel Bandwidth: 5 MHz				Channel Bandwidth: 10 MHz			
Channel	Frequency (MHz)	99 % Occupied Bandwidth (MHz)		Channel	Frequency (MHz)	99 % Occupied Bandwidth (MHz)	
		QPSK	16QAM			QPSK	16QAM
23035	701.5	1.0784	0.9190	23060	704.0	1.0922	0.9169
23095	707.5	1.0942	0.9186	23095	707.5	1.0897	0.9198
23155	713.5	1.0882	0.9186	23130	711.0	1.0924	0.9163

### Spectrum Plot of Worst Value

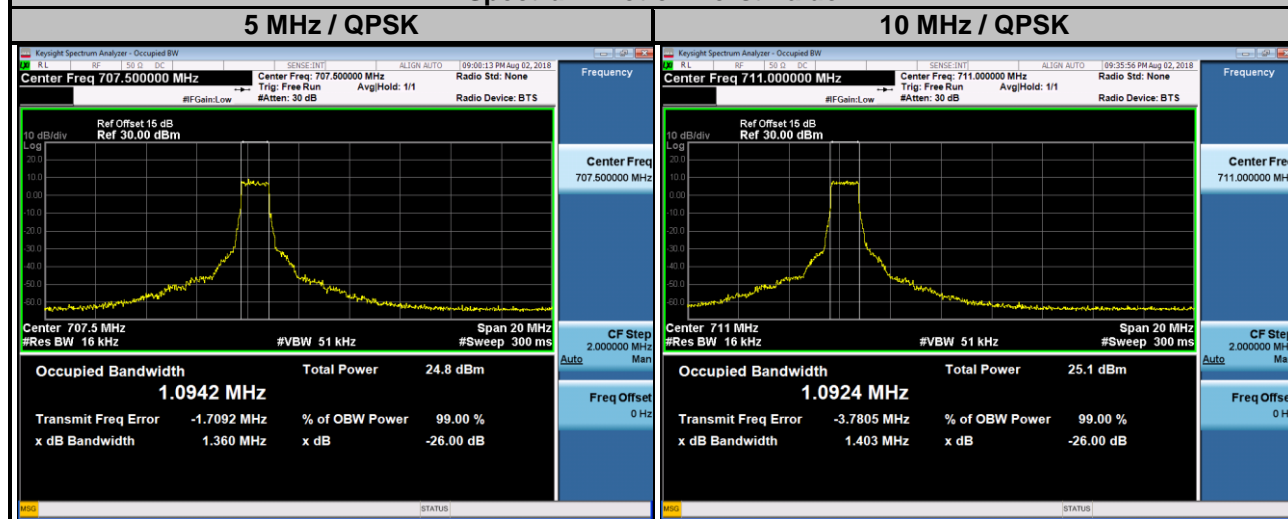

### LTE Band 66

Channel Bandwidth: 5 MHz				Channel Bandwidth: 10 MHz			
Channel	Frequency (MHz)	99 % Occupied Bandwidth (MHz)		Channel	Frequency (MHz)	99 % Occupied Bandwidth (MHz)	
		QPSK	16QAM			QPSK	16QAM
131997	1712.5	1.0897	0.9224	132022	1715.0	1.0918	0.9173
132322	1745.0	1.0950	0.9168	132322	1745.0	1.0890	0.9144
132647	1777.5	1.0869	0.9126	132622	1775.0	1.0930	0.9142

### Spectrum Plot of Worst Value

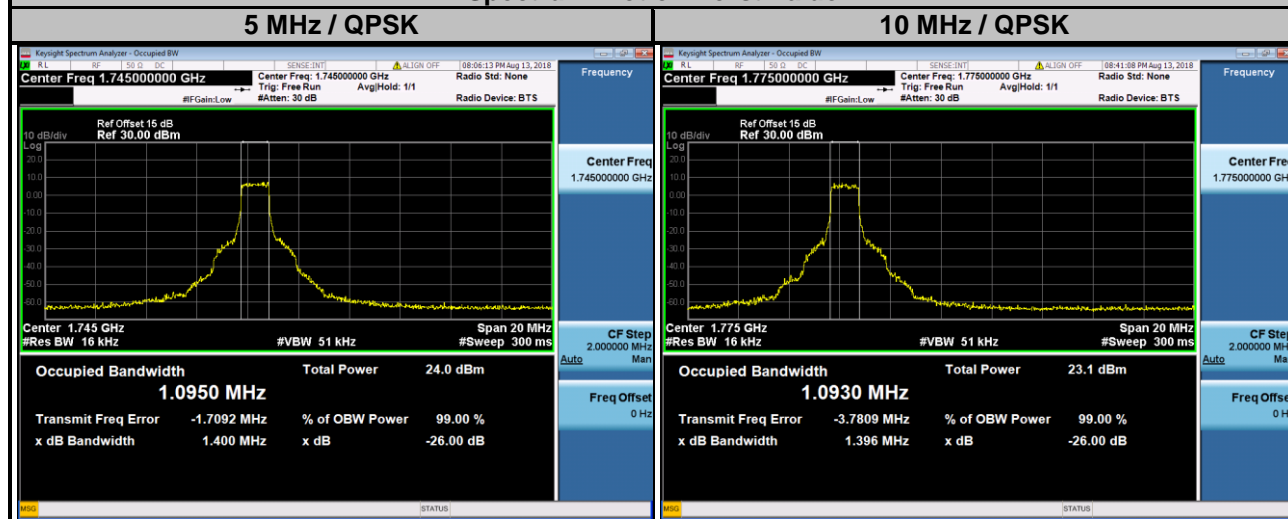

### LTE Band 66

Channel Bandwidth: 15 MHz				Channel Bandwidth: 20 MHz			
Channel	Frequency (MHz)	99 % Occupied Bandwidth (MHz)		Channel	Frequency (MHz)	99 % Occupied Bandwidth (MHz)	
		QPSK	16QAM			QPSK	16QAM
132047	1717.5	1.0789	0.9261	132072	1720.0	1.0911	0.9175
132322	1745.0	1.0919	0.9229	132322	1745.0	1.0913	0.9157
132597	1772.5	1.0816	0.9272	132572	1770.0	1.0979	0.9140

### Spectrum Plot of Worst Value

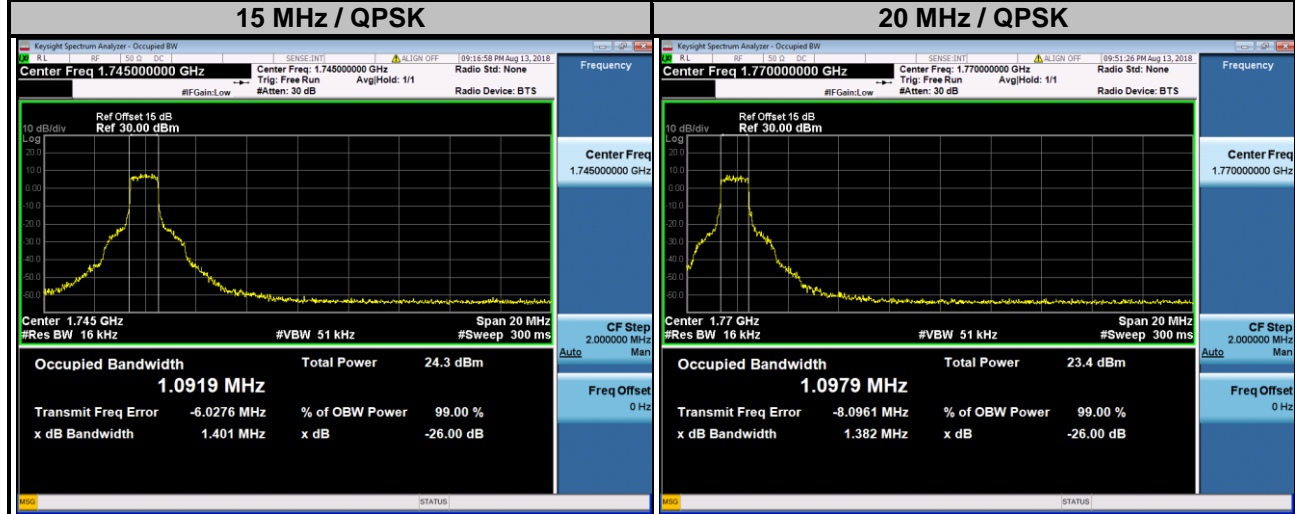



## 4.5 Band Edge Measurement

### 4.5.1 Limits of Band Edge Measurement

For operations in the 704-716 MHz band, the power of any emission outside a licensee's frequency band(s) of operation shall be attenuated below the transmitter power (P) within the licensed band(s) of operation, measured in watts, by at least  $43 + 10 \log (P)$  dB. Compliance with this provision is based on the use of measurement instrumentation employing a resolution bandwidth of 100 kilohertz or greater.

However, in the 100 kilohertz bands immediately outside and adjacent to a licensee's frequency block, a resolution bandwidth of at least 30 kHz may be employed.

For operations in the 1710–1755 MHz bands, the power of any emission outside a licensee's frequency block shall be attenuated below the transmitter power (P) by at least  $43 + 10 \log (P)$  dB.

### 4.5.2 Test Setup

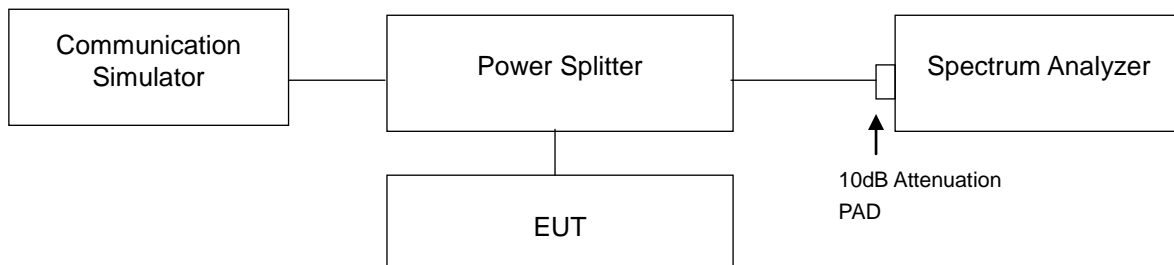

### 4.5.3 Test Procedures

- All measurements were done at low and high operational frequency range.
- The center frequency of spectrum is the band edge frequency and span is 1 MHz. RB of the spectrum is 16 kHz and VB of the spectrum is 51 kHz.
- Record the max. trace plot into the test report.

### 4.5.4 Test Results

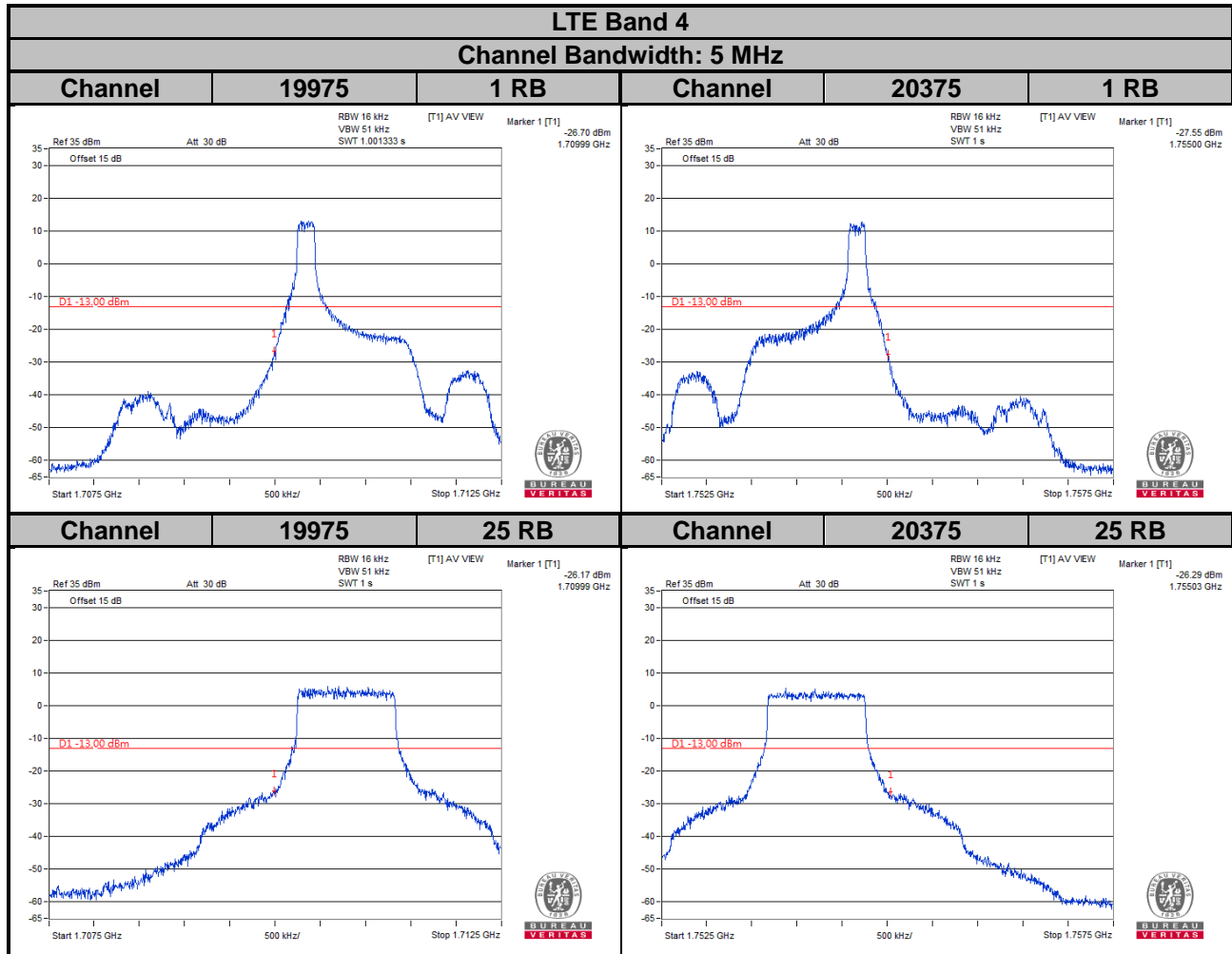

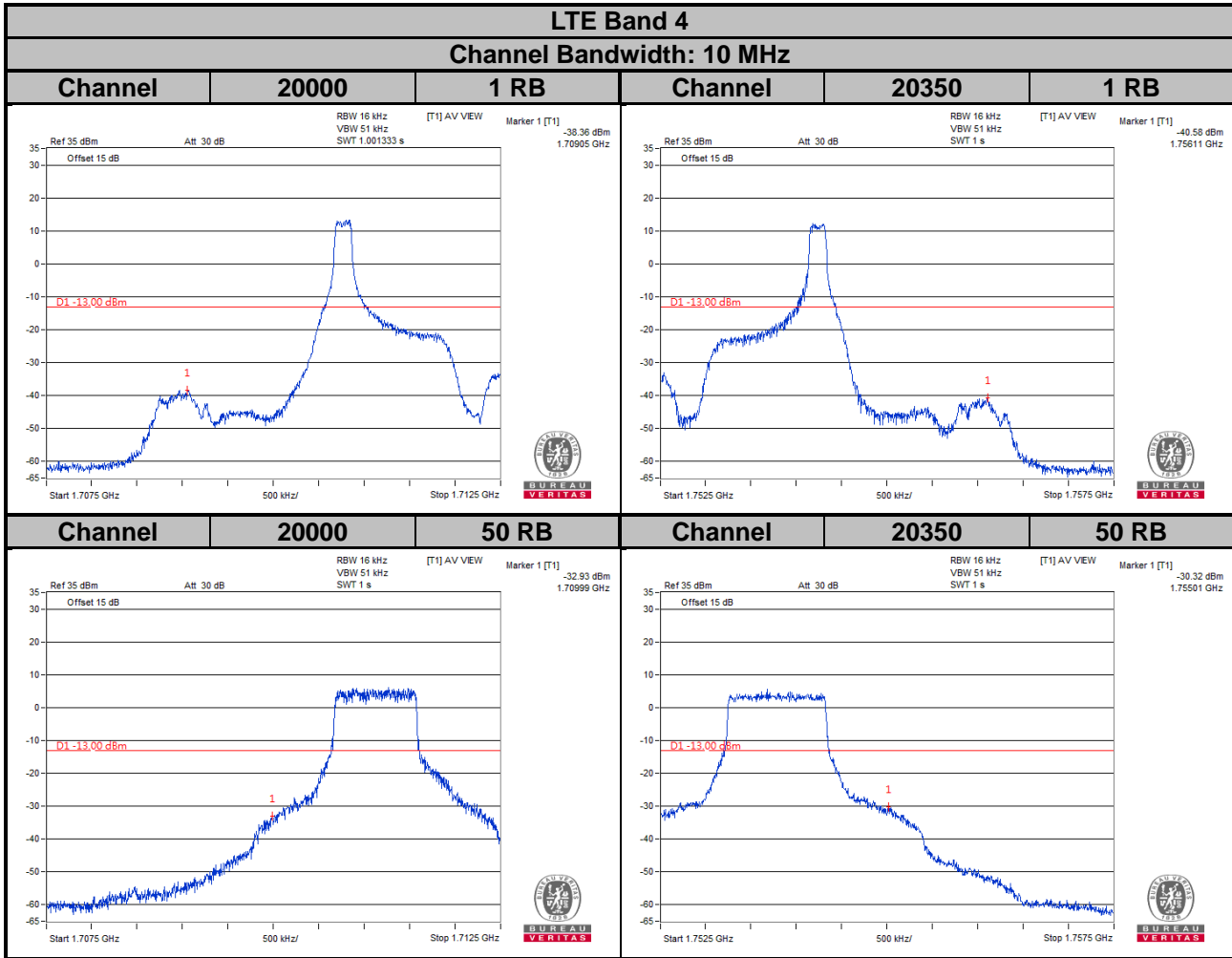

**LTE Band 4**  
**Channel Bandwidth: 15 MHz**

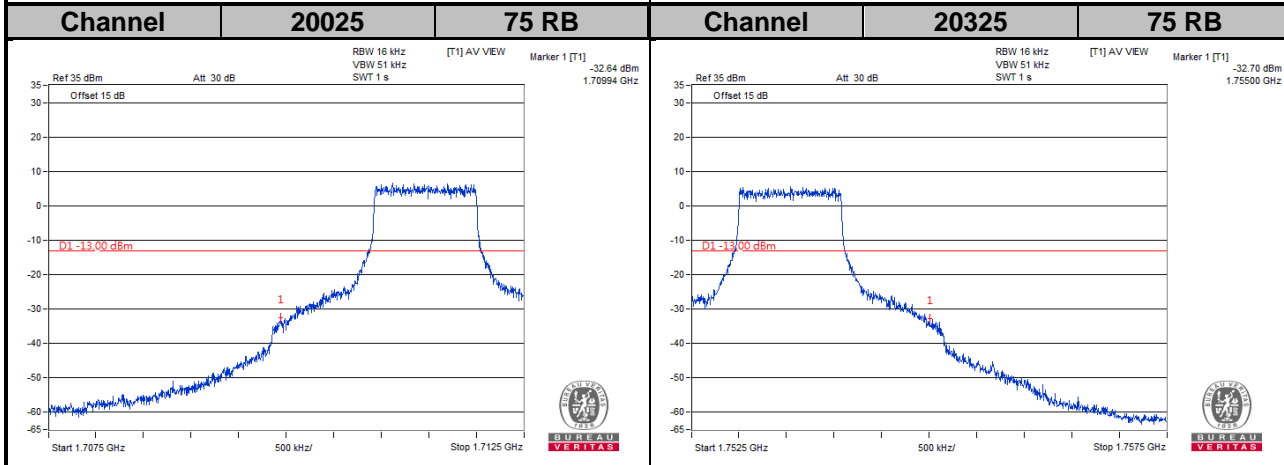
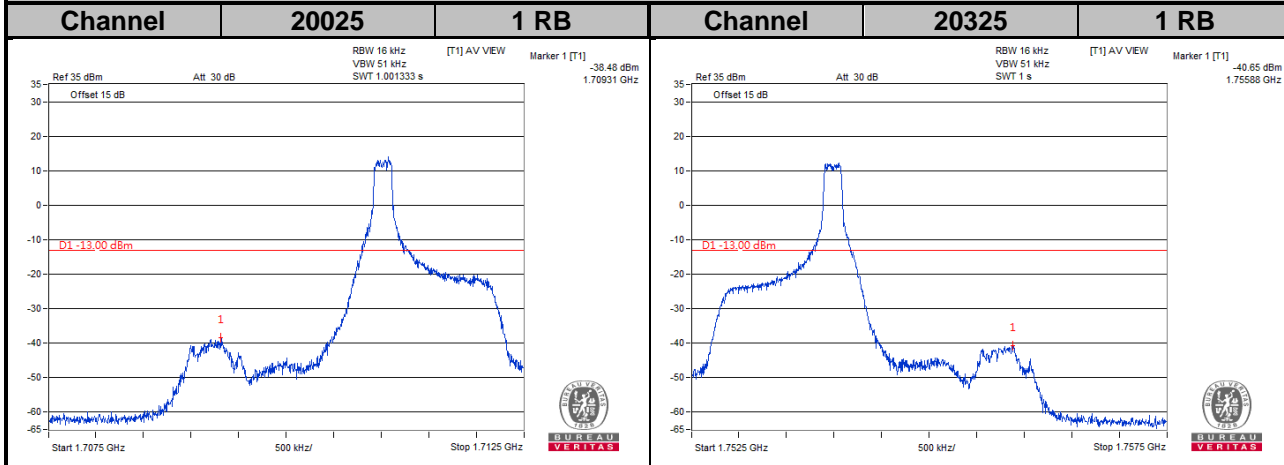

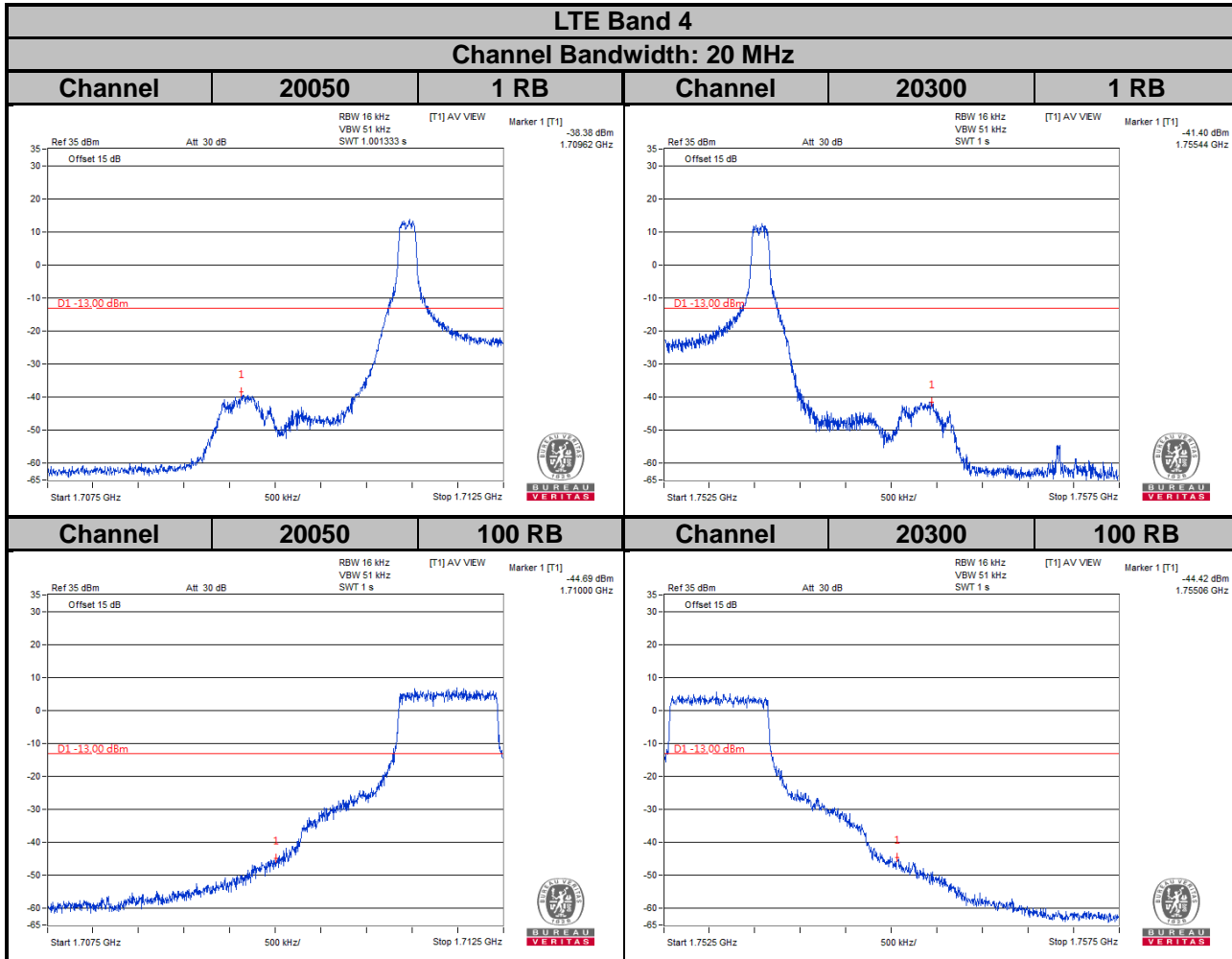

**LTE Band 12**  
**Channel Bandwidth: 5 MHz**

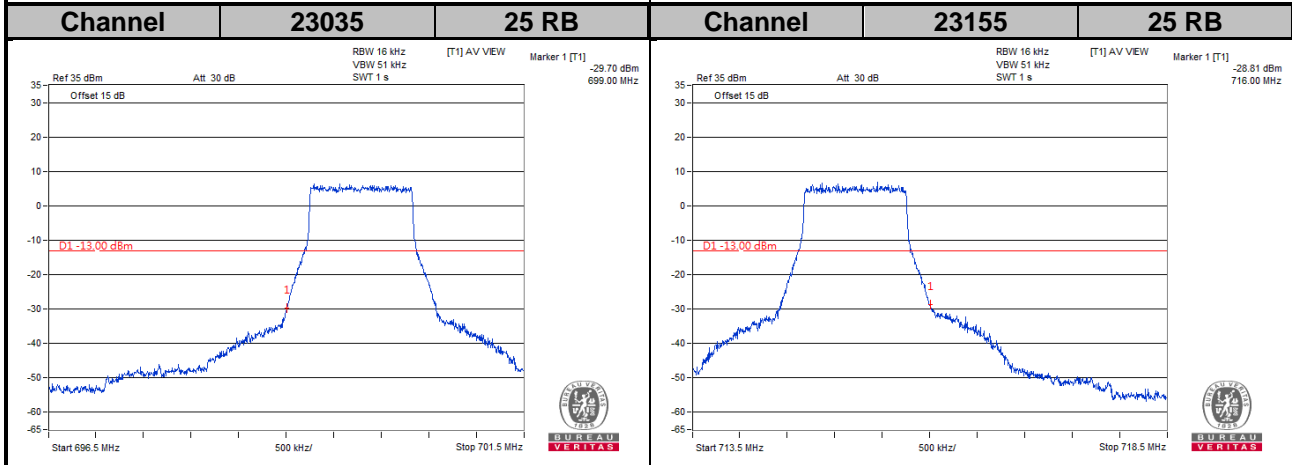
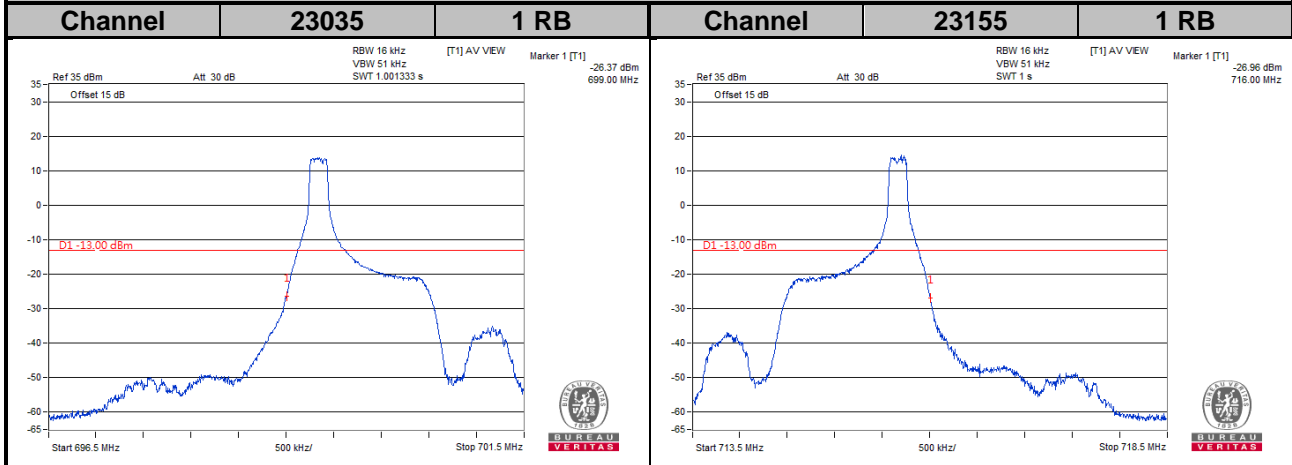

**LTE Band 12**  
**Channel Bandwidth: 10 MHz**

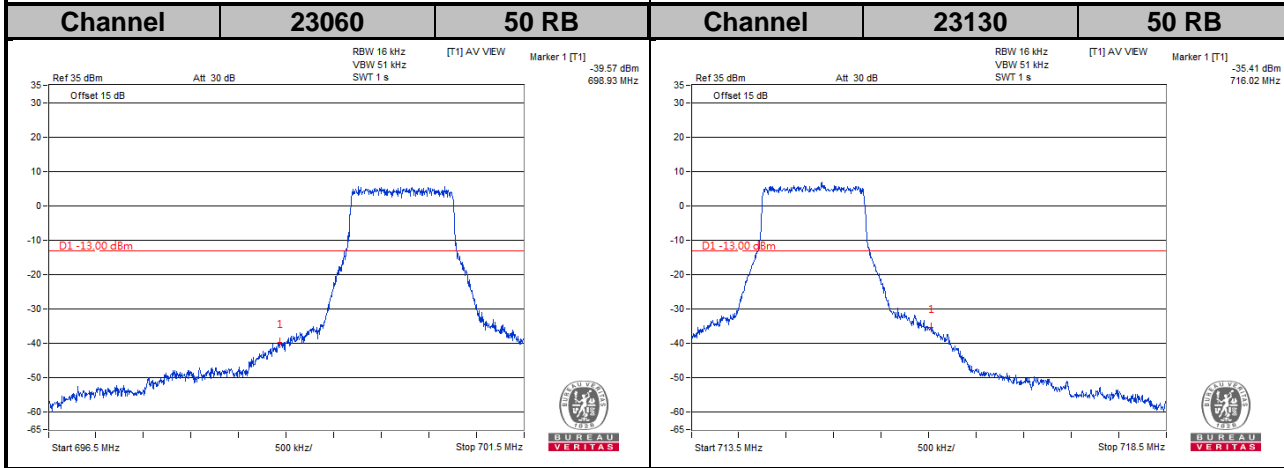
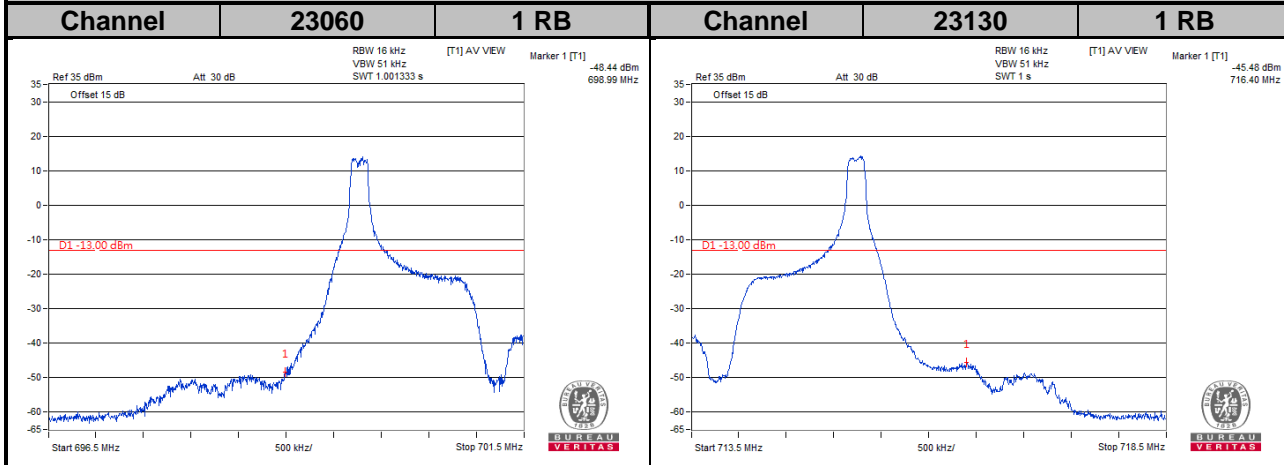

**LTE Band 66**  
**Channel Bandwidth: 5 MHz**

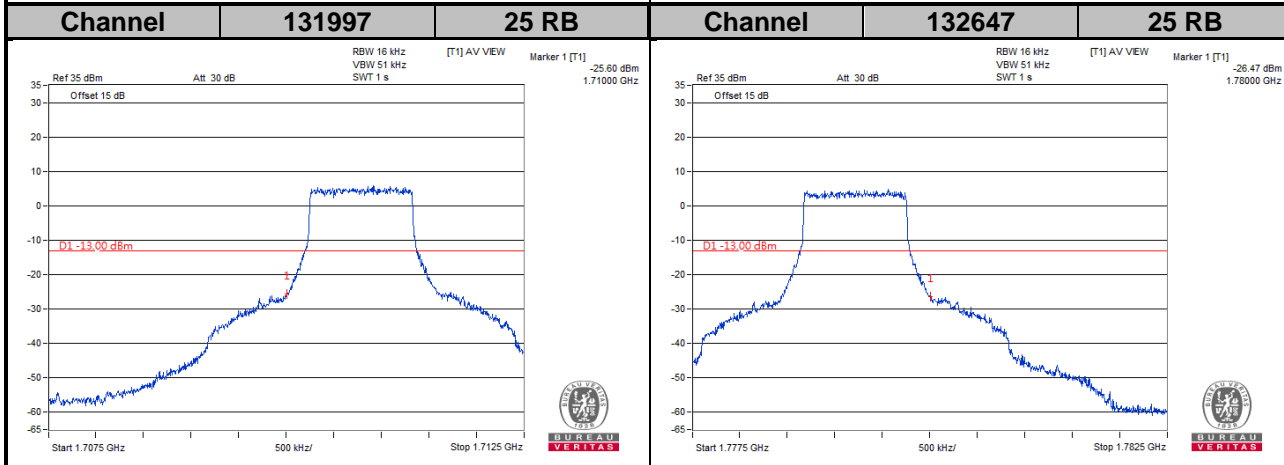
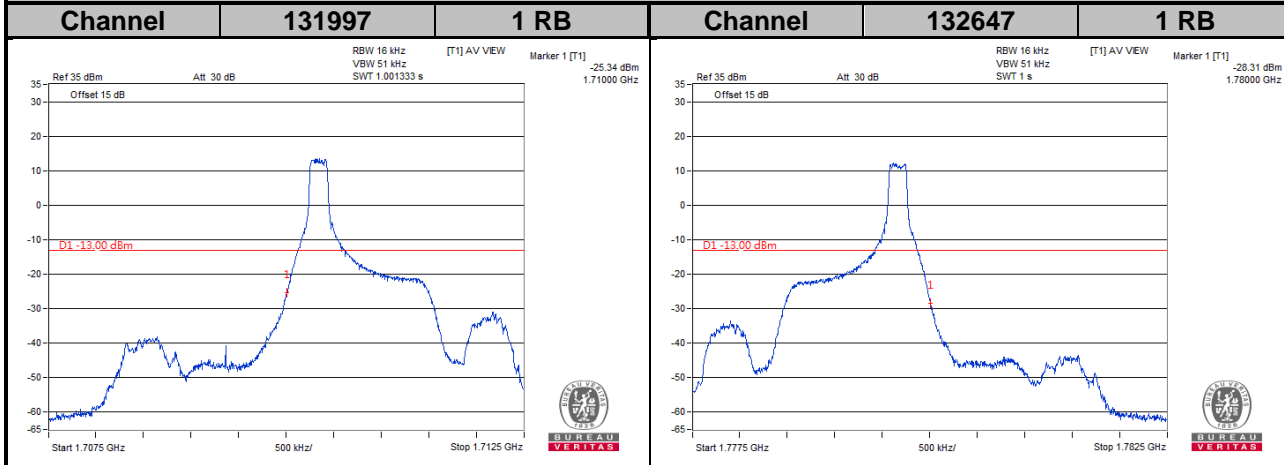



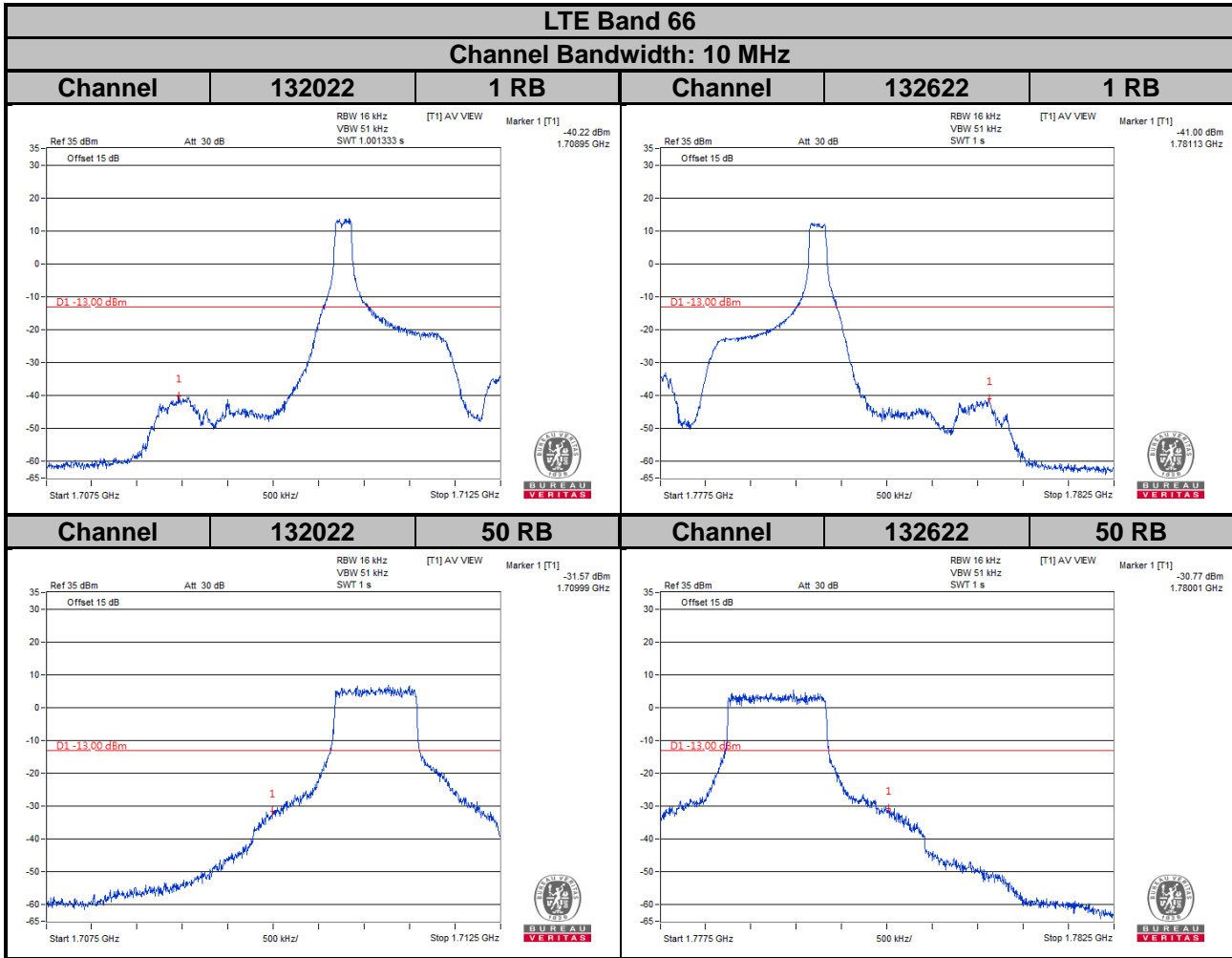

**LTE Band 66**  
**Channel Bandwidth: 15 MHz**

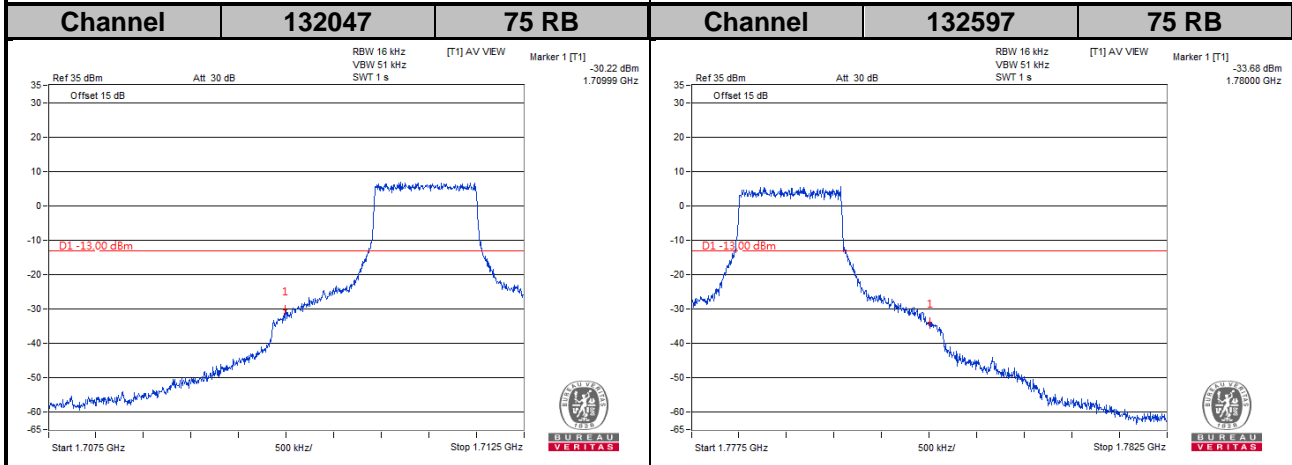
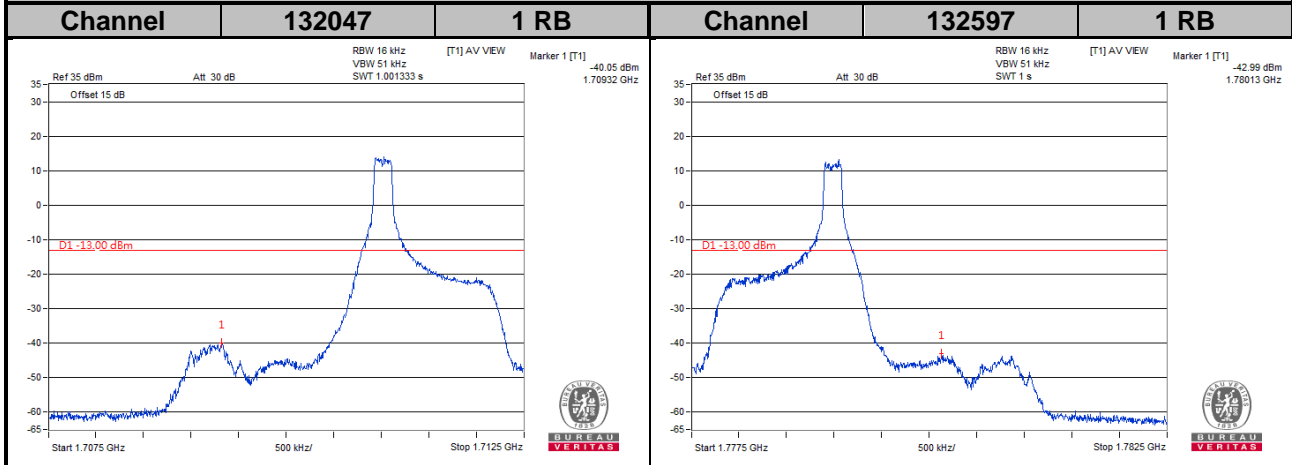

**LTE Band 66**  
**Channel Bandwidth: 20 MHz**

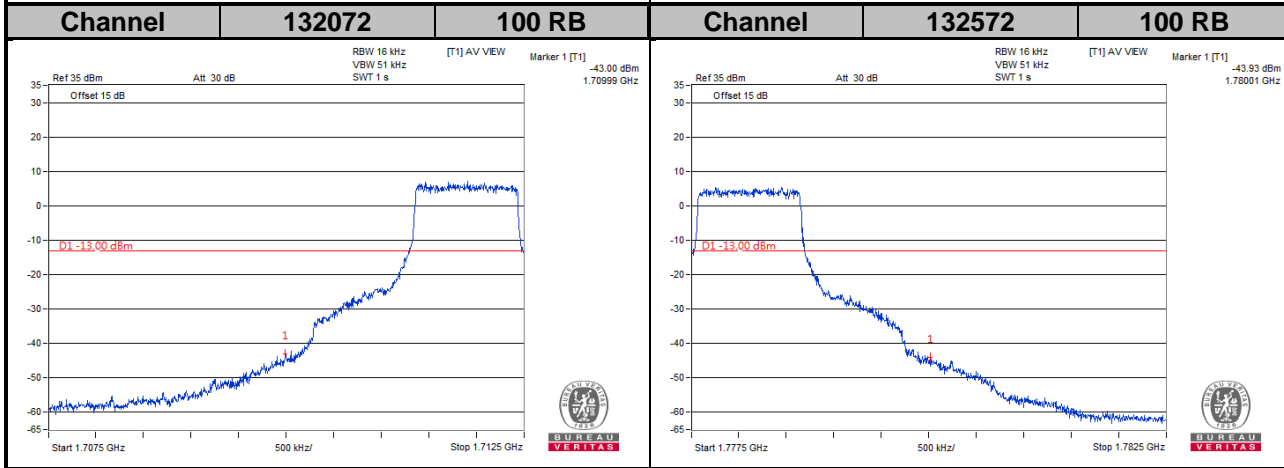
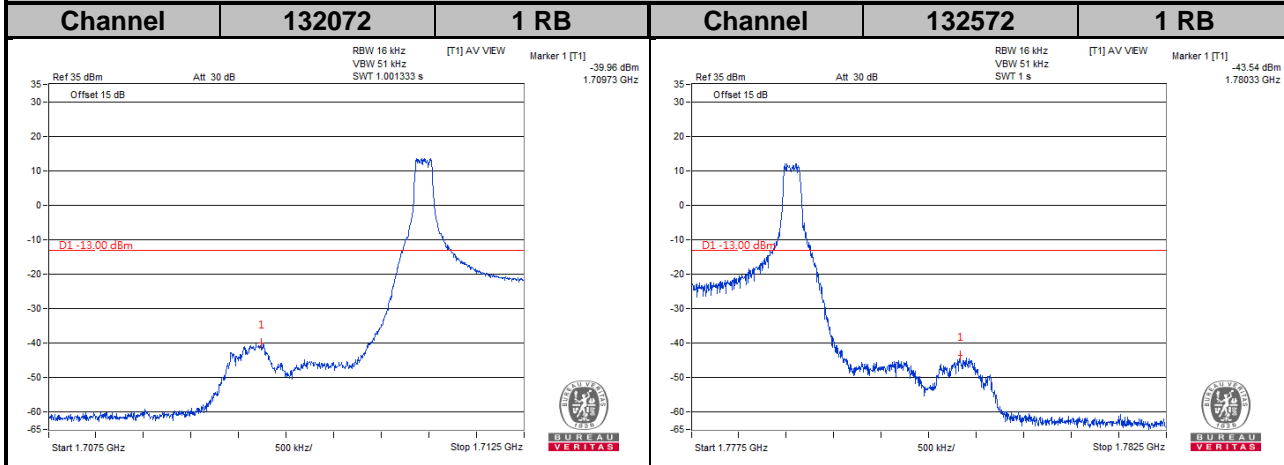

## 4.6 Peak to Average Ratio

### 4.6.1 Limits of Peak to Average Ratio Measurement

In measuring transmissions in this band using an average power technique, the peak to-average ratio (PAR) of the transmission may not exceed 13 dB.

### 4.6.2 Test Setup

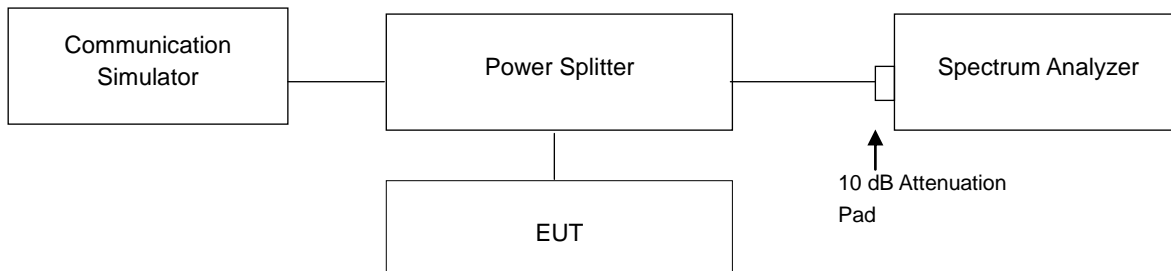

### 4.6.3 Test Procedures

1. Set resolution/measurement bandwidth  $\geq$  signal's occupied bandwidth;
2. Set the number of counts to a value that stabilizes the measured CCDF curve;
3. Record the maximum PAPR level associated with a probability of 0.1 %.

#### 4.6.4 Test Results

LTE Band 4							
Channel Bandwidth: 5 MHz				Channel Bandwidth: 10 MHz			
Channel	Frequency (MHz)	Peak to Average Ratio (dB)		Channel	Frequency (MHz)	Peak to Average Ratio (dB)	
		QPSK	16QAM			QPSK	16QAM
19975	1712.5	4.33	4.75	20000	1715.0	4.36	5.07
20175	1732.5	4.52	4.71	20175	1732.5	4.37	4.75
20375	1752.5	4.51	4.70	20350	1750.0	4.36	5.34

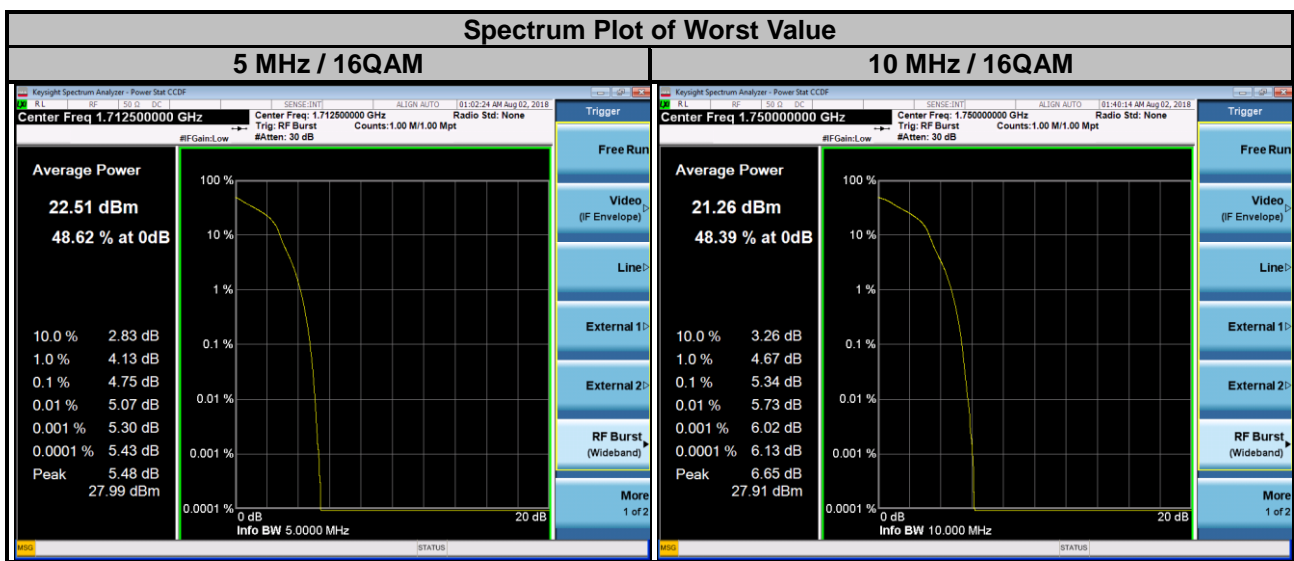

LTE Band 4							
Channel Bandwidth: 15 MHz				Channel Bandwidth: 20 MHz			
Channel	Frequency (MHz)	Peak to Average Ratio (dB)		Channel	Frequency (MHz)	Peak to Average Ratio (dB)	
		QPSK	16QAM			QPSK	16QAM
20025	1717.5	4.28	4.81	20050	1720.0	4.29	4.84
20175	1732.5	4.47	4.80	20175	1732.5	4.62	4.71
20325	1747.5	4.56	4.78	20300	1745.0	4.42	4.94

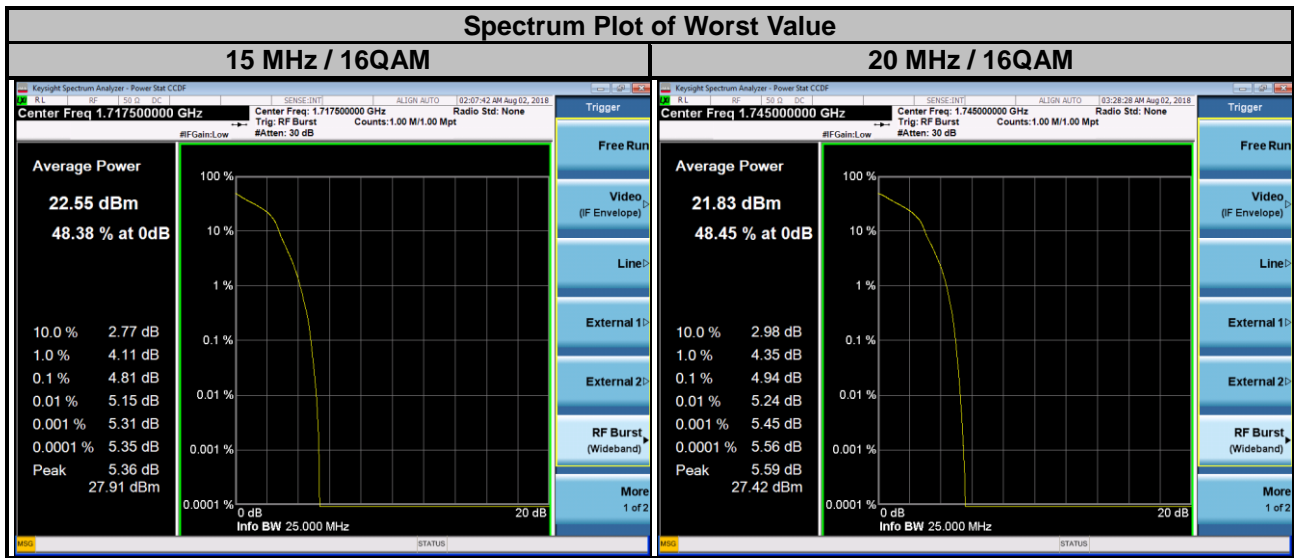

### LTE Band 12

Channel Bandwidth: 5 MHz				Channel Bandwidth: 10 MHz			
Channel	Frequency (MHz)	Peak to Average Ratio (dB)		Channel	Frequency (MHz)	Peak to Average Ratio (dB)	
		QPSK	16QAM			QPSK	16QAM
23035	701.5	4.96	5.12	23060	704.0	4.79	5.77
23095	707.5	4.68	5.18	23095	707.5	4.75	5.51
23155	713.5	4.63	5.04	23130	711.0	4.68	5.09

### Spectrum Plot of Worst Value

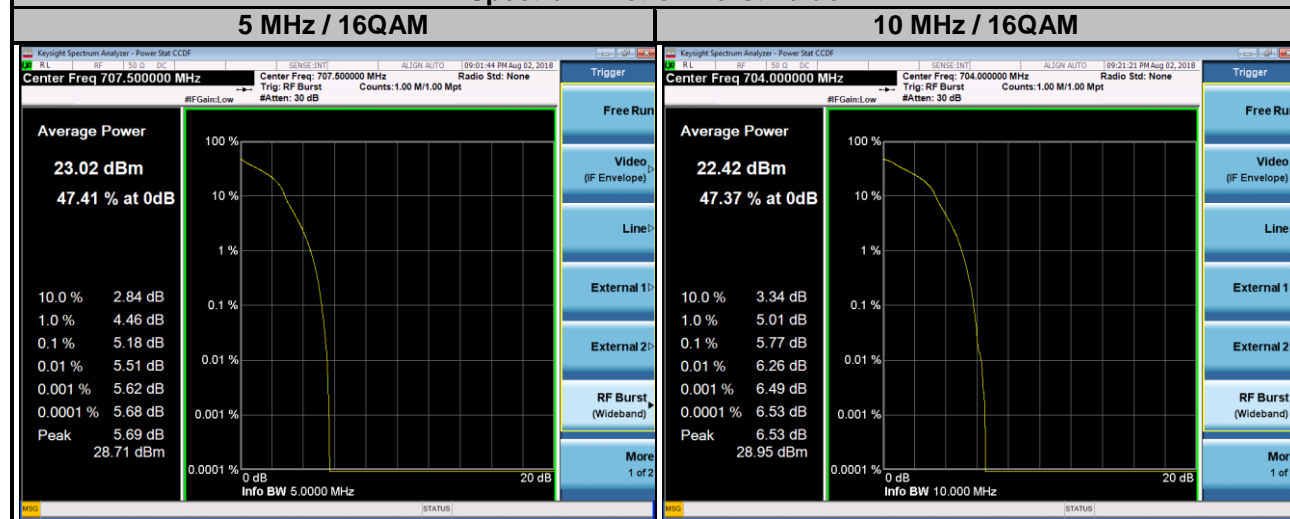

### LTE Band 66

Channel Bandwidth: 5 MHz				Channel Bandwidth: 10 MHz			
Channel	Frequency (MHz)	Peak to Average Ratio (dB)		Channel	Frequency (MHz)	Peak to Average Ratio (dB)	
		QPSK	16QAM			QPSK	16QAM
131997	1712.5	4.47	4.67	132022	1715.0	4.29	4.69
132322	1745.0	4.26	4.65	132322	1745.0	4.52	4.77
132647	1777.5	4.49	4.71	132622	1775.0	4.38	4.77

### Spectrum Plot of Worst Value

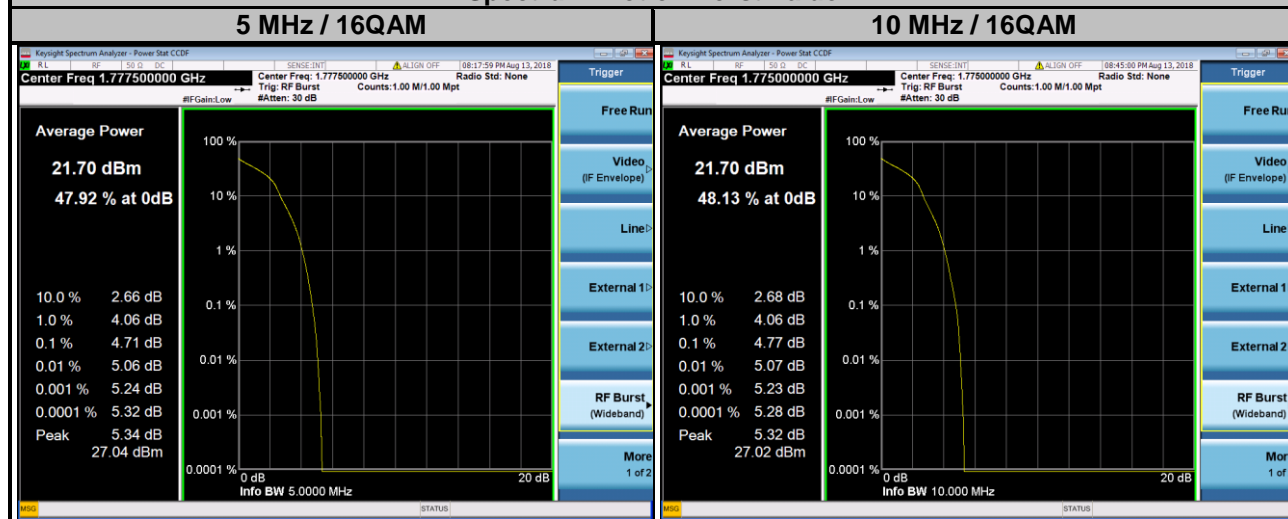



### LTE Band 66

Channel Bandwidth: 15 MHz				Channel Bandwidth: 20 MHz			
Channel	Frequency (MHz)	Peak to Average Ratio (dB)		Channel	Frequency (MHz)	Peak to Average Ratio (dB)	
		QPSK	16QAM			QPSK	16QAM
132047	1717.5	4.70	5.01	132072	1720.0	4.69	4.68
132322	1745.0	4.70	4.70	132322	1745.0	4.40	4.77
132597	1772.5	4.54	4.79	132572	1770.0	4.50	4.96

### Spectrum Plot of Worst Value

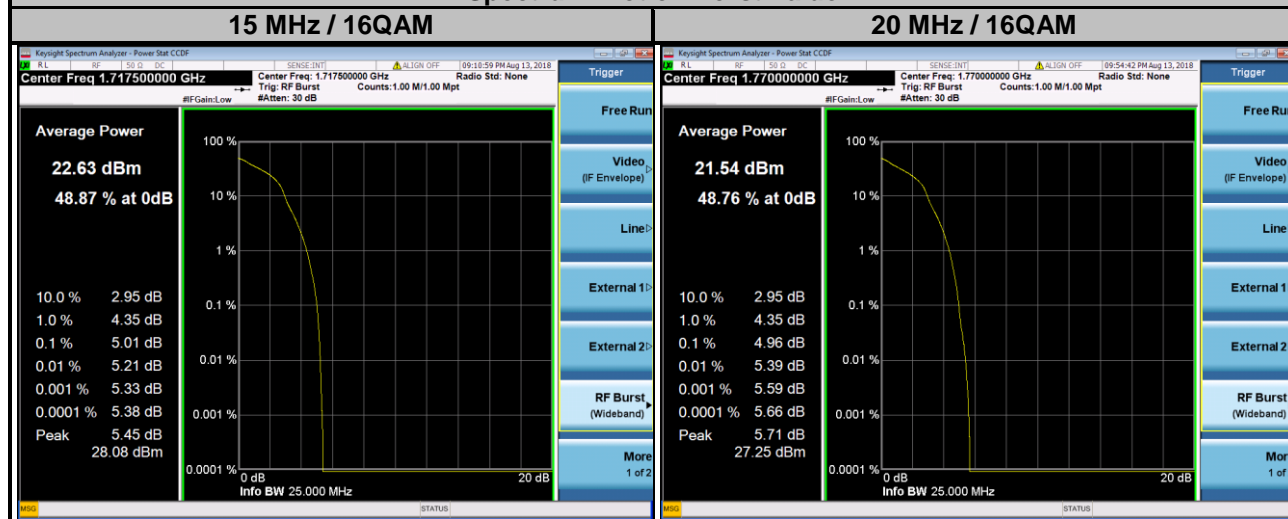

## 4.7 Conducted Spurious Emissions

### 4.7.1 Limits of Conducted Spurious Emissions Measurement

The power of any emission outside a licensee's frequency block shall be attenuated below the transmitter power (P) by at least  $43 + 10 \log (P)$  dB. The limit of emission is equal to -13 dBm.

### 4.7.2 Test Setup

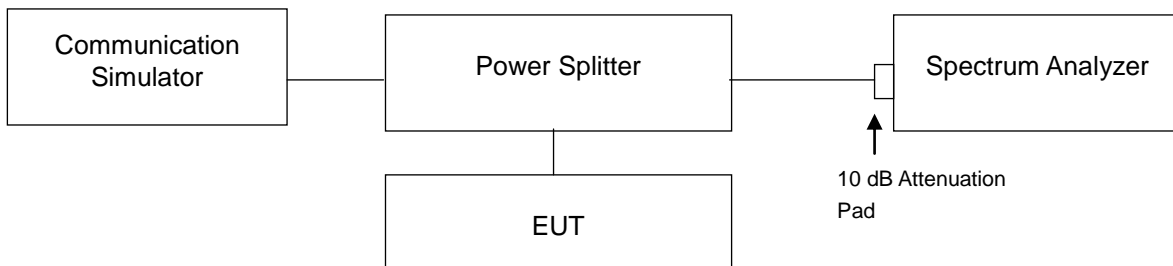

### 4.7.3 Test Procedure

- The EUT makes a phone call to the communication simulator. All measurements were done at low, middle and high operational frequency range.
- Measuring frequency range is from 9 kHz to 1 GHz. 10 dB attenuation pad is connected with spectrum. RBW = 100 kHz and VBW = 300 kHz is used for conducted emission measurement.
- Measuring frequency range is from 1 GHz to 27 GHz. 10 dB attenuation pad is connected with spectrum. RBW = 1 MHz and VBW = 3 MHz is used for conducted emission measurement.

### 4.7.4 Test Results

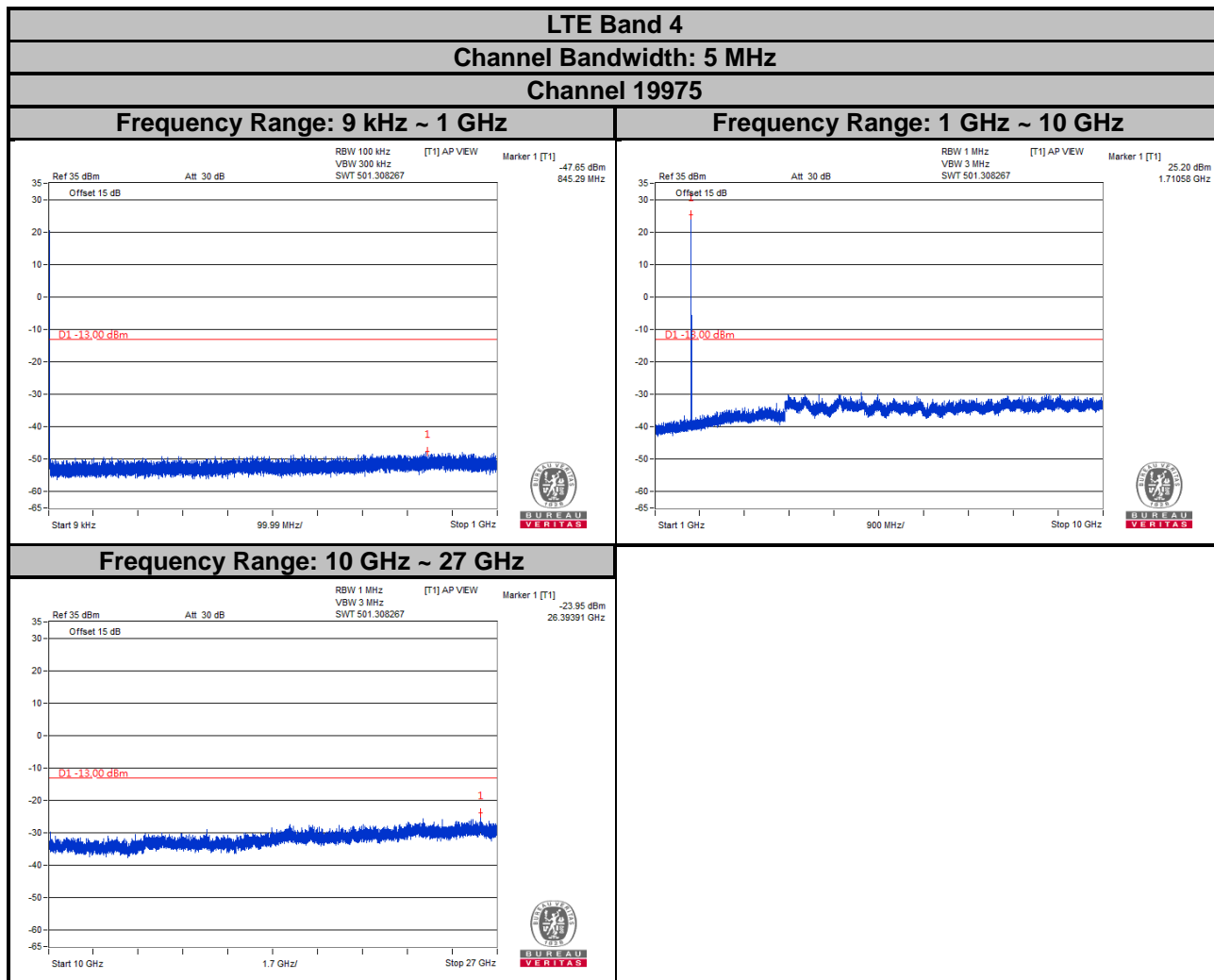

**LTE Band 4**

**Channel Bandwidth: 5 MHz**

**Channel 20175**

**Frequency Range: 9 kHz ~ 1 GHz**

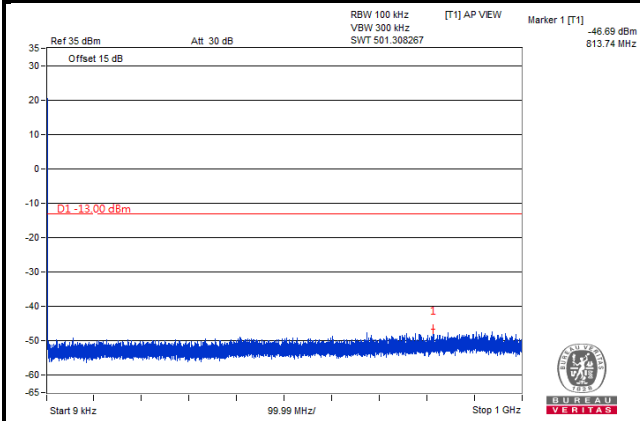

**Frequency Range: 1 GHz ~ 10 GHz**

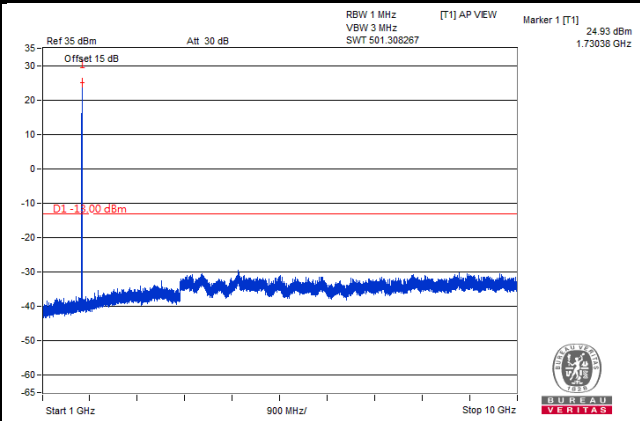

**Frequency Range: 10 GHz ~ 27 GHz**

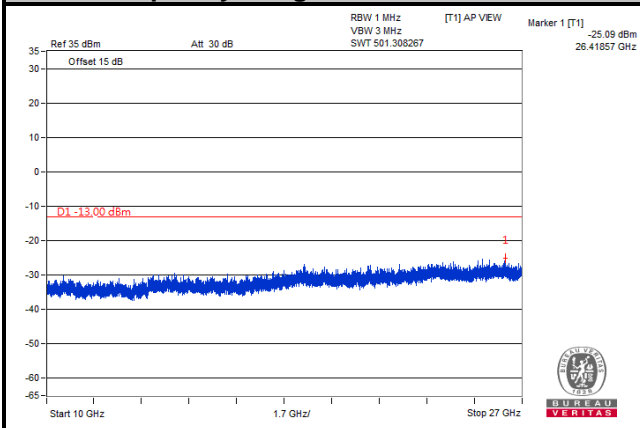

### LTE Band 4

Channel Bandwidth: 5 MHz

Channel 20375

Frequency Range: 9 kHz ~ 1 GHz

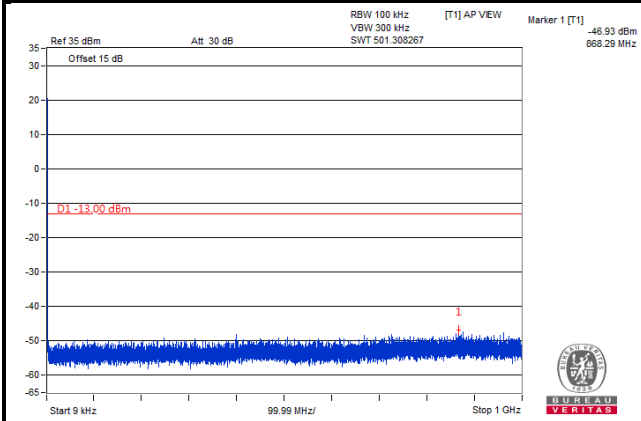

Frequency Range: 1 GHz ~ 10 GHz

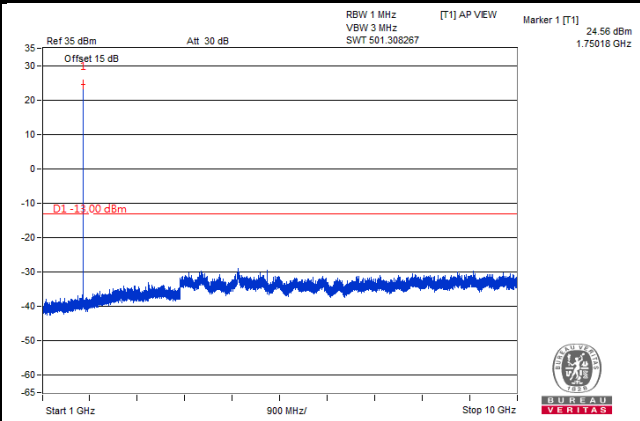

Frequency Range: 10 GHz ~ 27 GHz

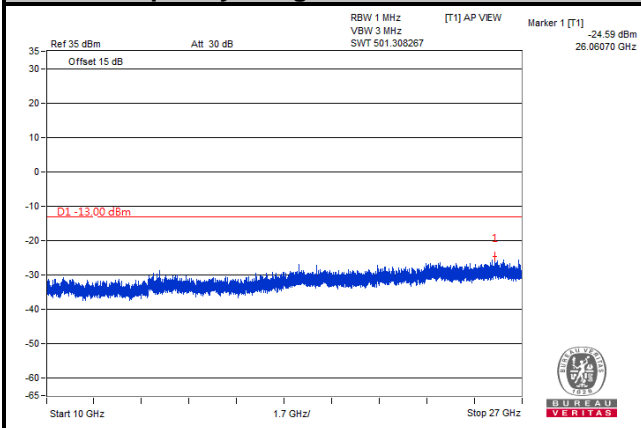

**LTE Band 4**  
**Channel Bandwidth: 10 MHz**  
**Channel 20000**

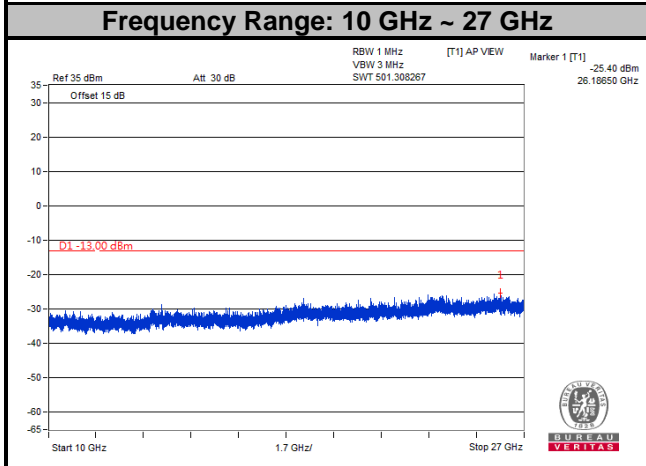
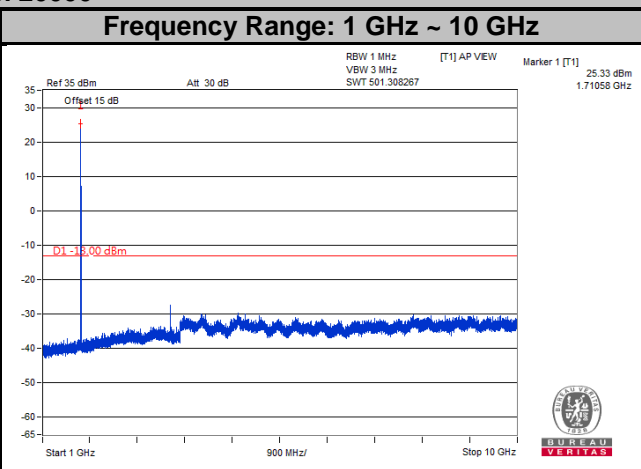
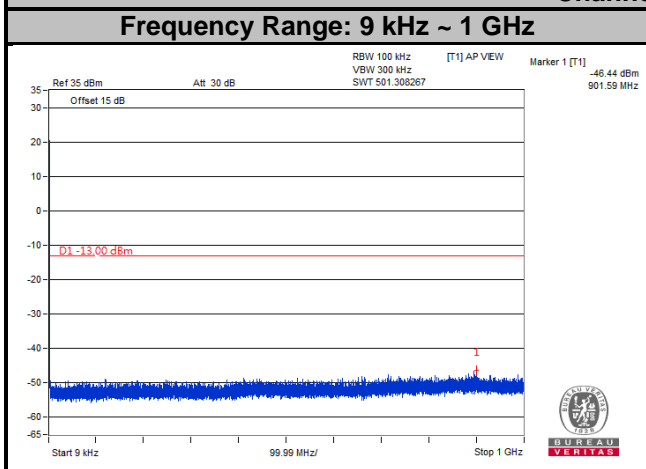

**LTE Band 4**

**Channel Bandwidth: 10 MHz**

**Channel 20175**

**Frequency Range: 9 kHz ~ 1 GHz**

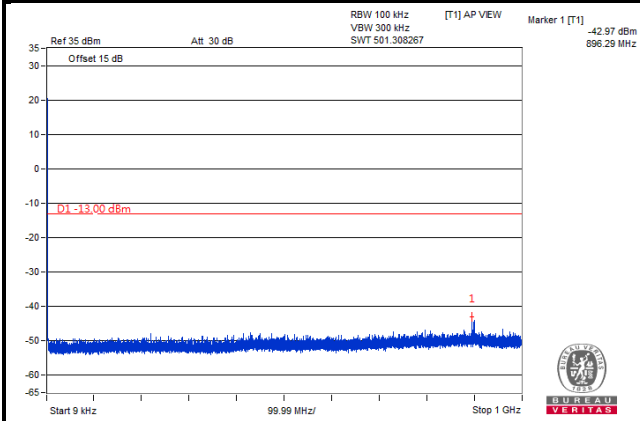

**Frequency Range: 1 GHz ~ 10 GHz**

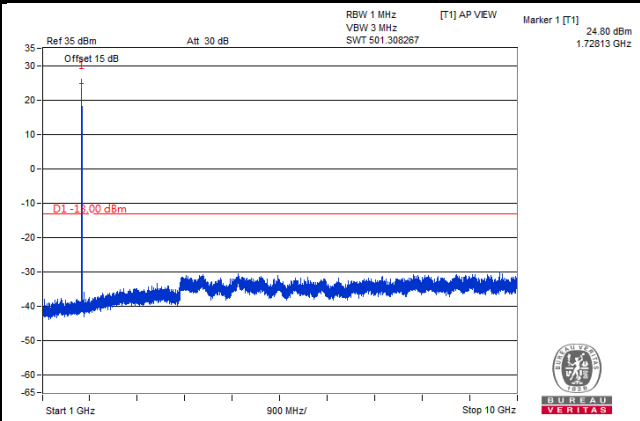

**Frequency Range: 10 GHz ~ 27 GHz**

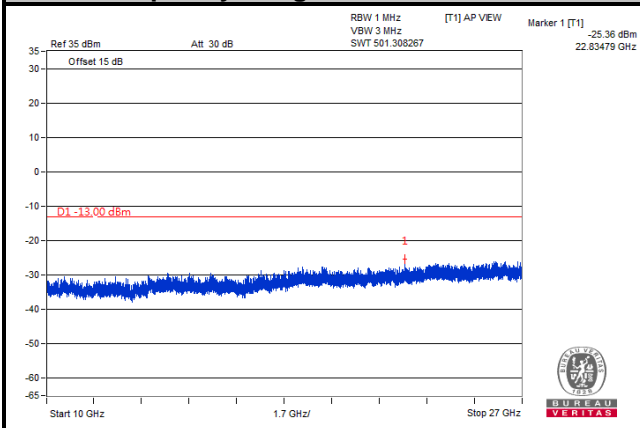

### LTE Band 4

Channel Bandwidth: 10 MHz

Channel 20350

Frequency Range: 9 kHz ~ 1 GHz

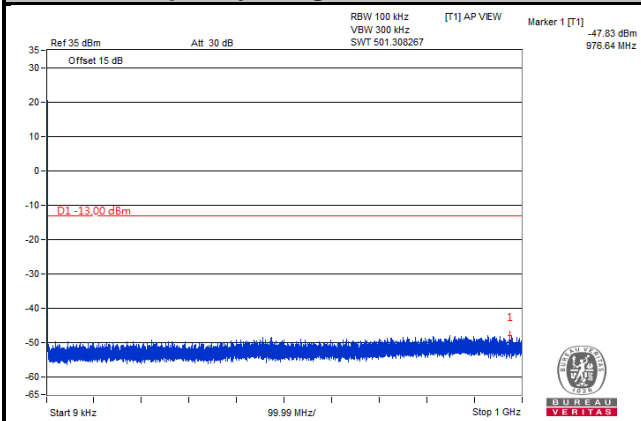

Frequency Range: 1 GHz ~ 10 GHz

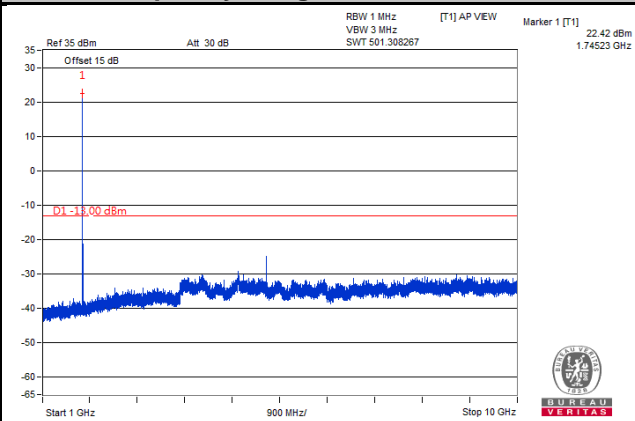

Frequency Range: 10 GHz ~ 27 GHz

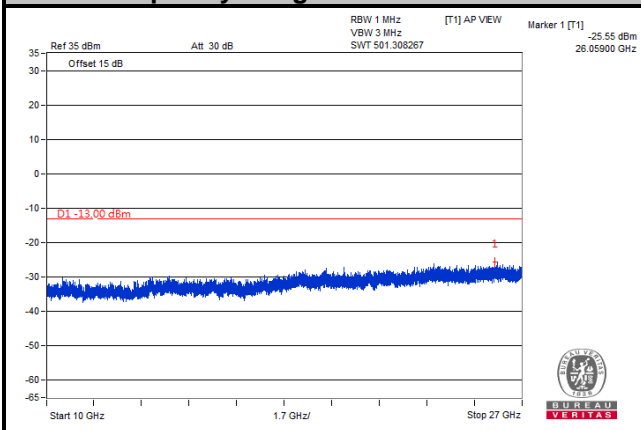



**LTE Band 4**  
**Channel Bandwidth: 15 MHz**  
**Channel 20025**

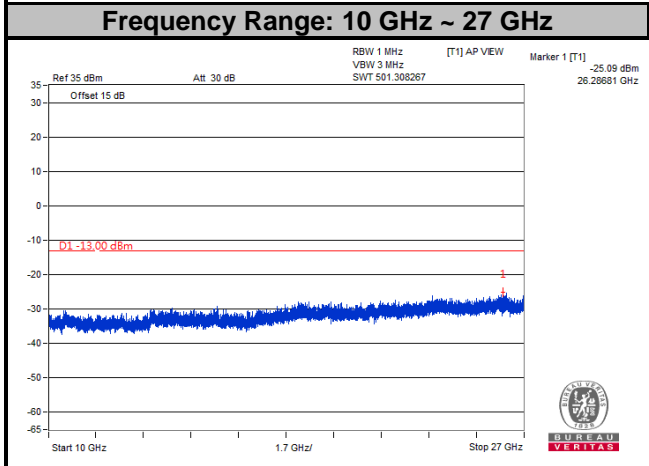
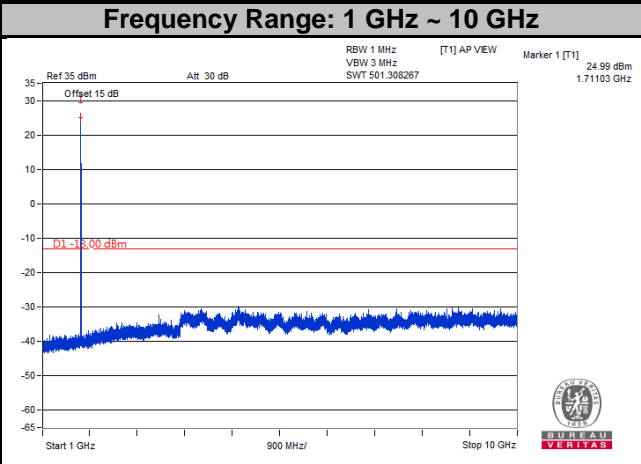
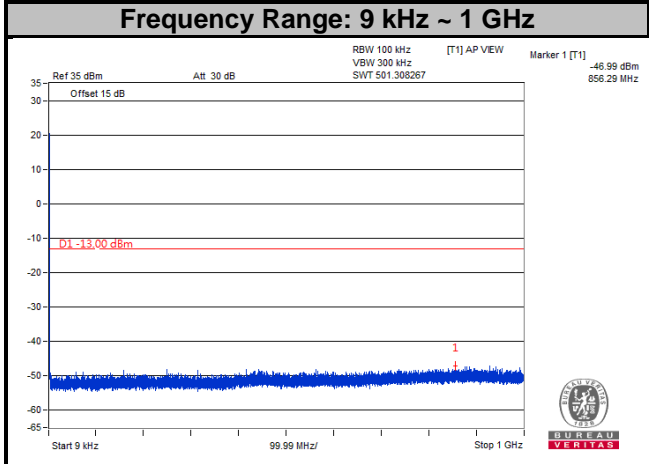

**LTE Band 4**

**Channel Bandwidth: 15 MHz**

**Channel 20175**

**Frequency Range: 9 kHz ~ 1 GHz**

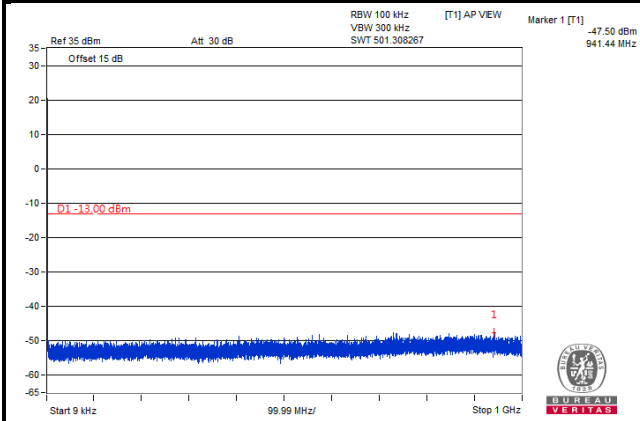

**Frequency Range: 1 GHz ~ 10 GHz**

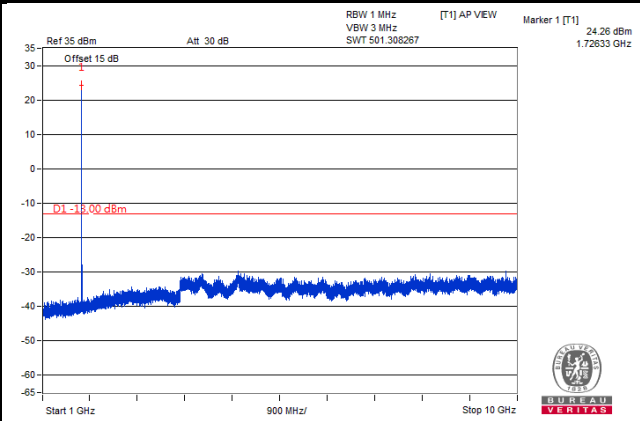

**Frequency Range: 10 GHz ~ 27 GHz**

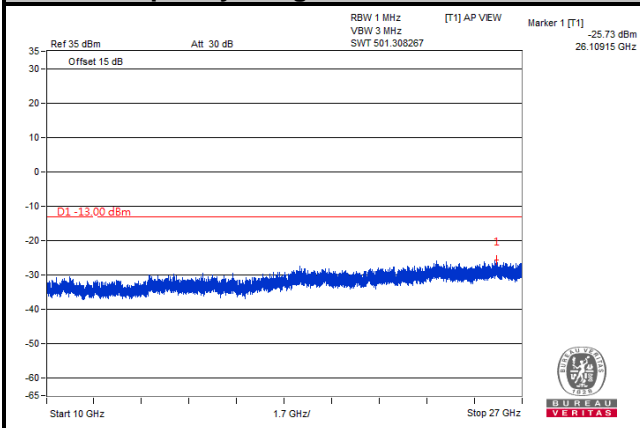

**LTE Band 4**

**Channel Bandwidth: 15 MHz**

**Channel 20325**

**Frequency Range: 9 kHz ~ 1 GHz**

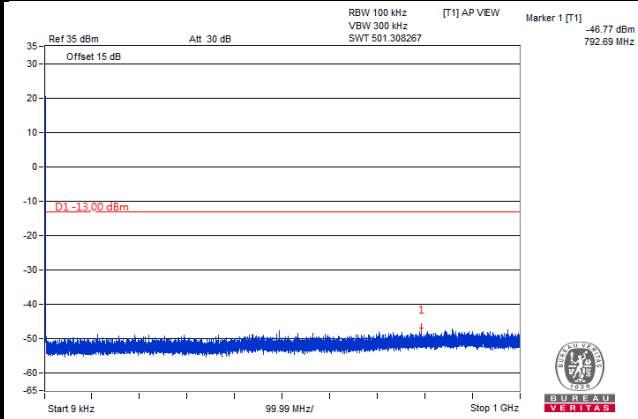

**Frequency Range: 1 GHz ~ 10 GHz**

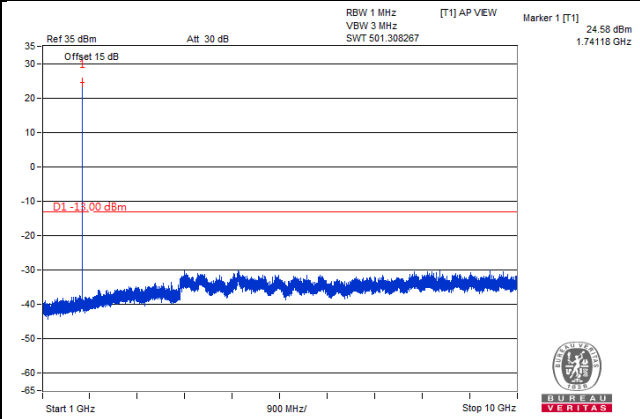

**Frequency Range: 10 GHz ~ 27 GHz**

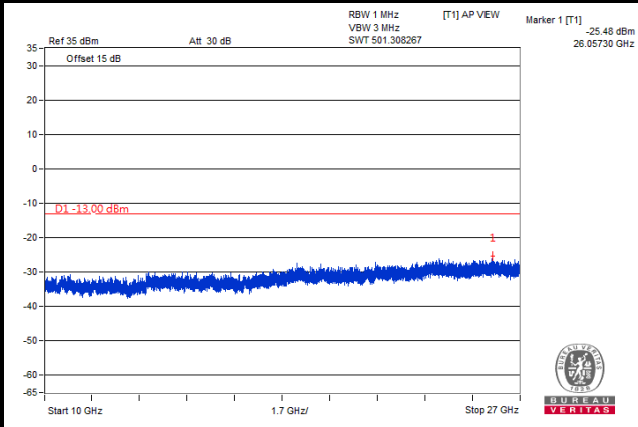

**LTE Band 4**  
**Channel Bandwidth: 20 MHz**  
**Channel 20050**

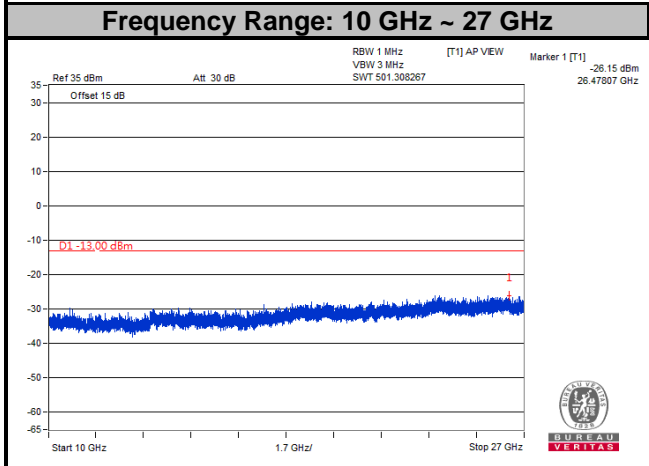
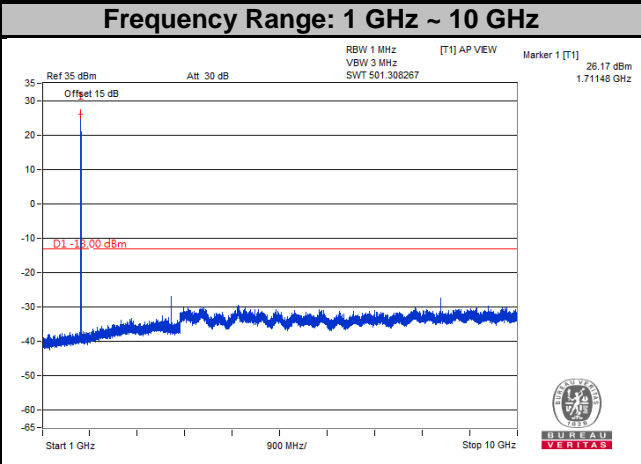
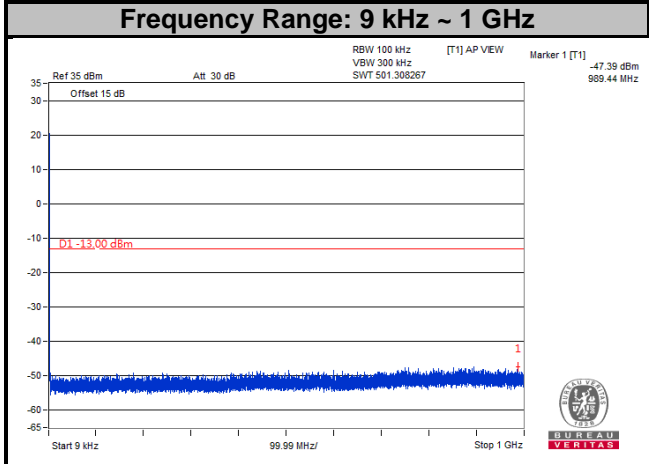

**LTE Band 4**

**Channel Bandwidth: 20 MHz**

**Channel 20175**

**Frequency Range: 9 kHz ~ 1 GHz**

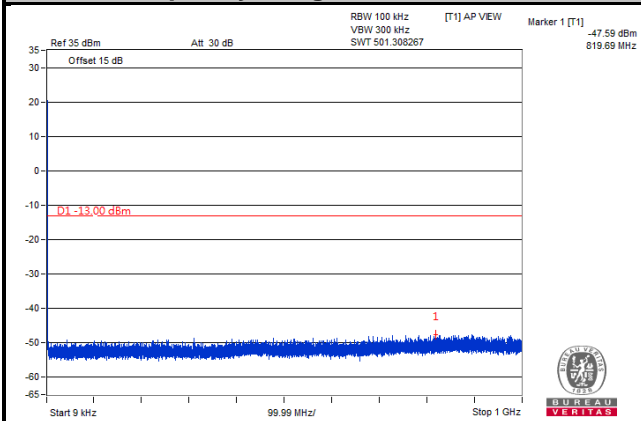

**Frequency Range: 1 GHz ~ 10 GHz**

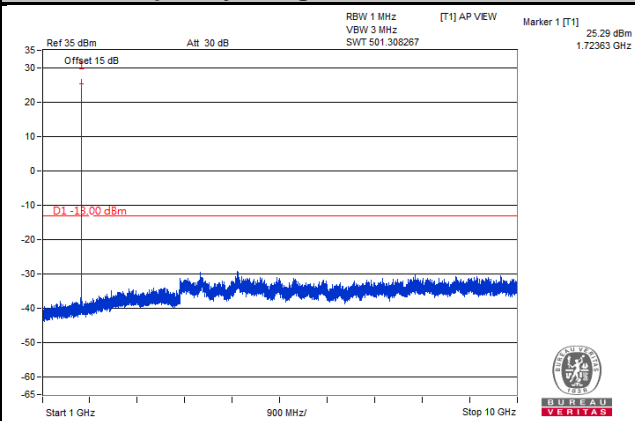

**Frequency Range: 10 GHz ~ 27 GHz**

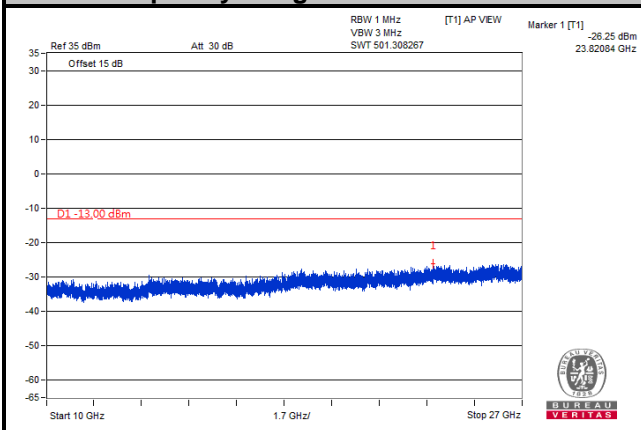

**LTE Band 4**

**Channel Bandwidth: 20 MHz**

**Channel 20300**

**Frequency Range: 9 kHz ~ 1 GHz**

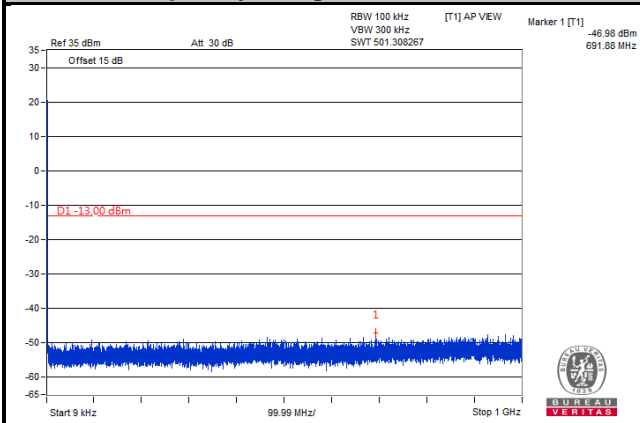

**Frequency Range: 1 GHz ~ 10 GHz**

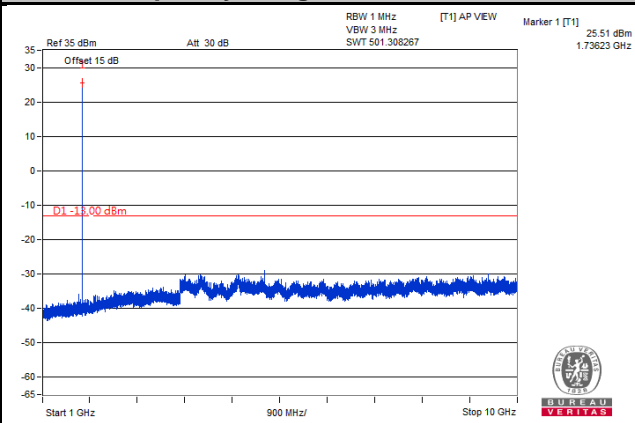

**Frequency Range: 10 GHz ~ 27 GHz**

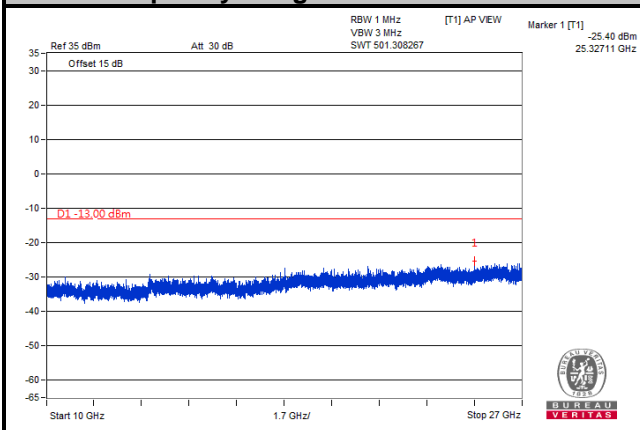

### LTE Band 12

Channel Bandwidth: 5 MHz

### Channel 23035

Frequency Range: 9 kHz ~ 1 GHz

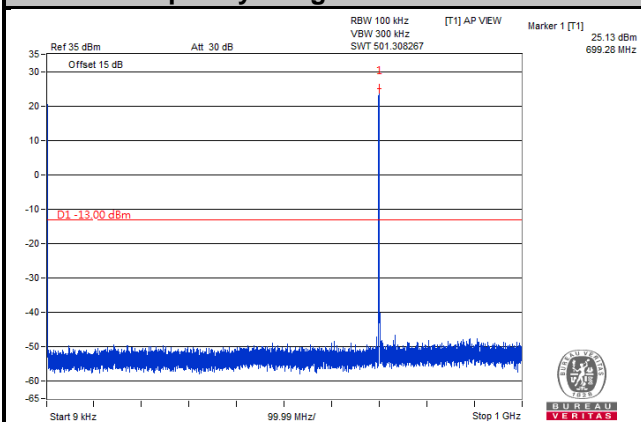

Frequency Range: 1 GHz ~ 10 GHz

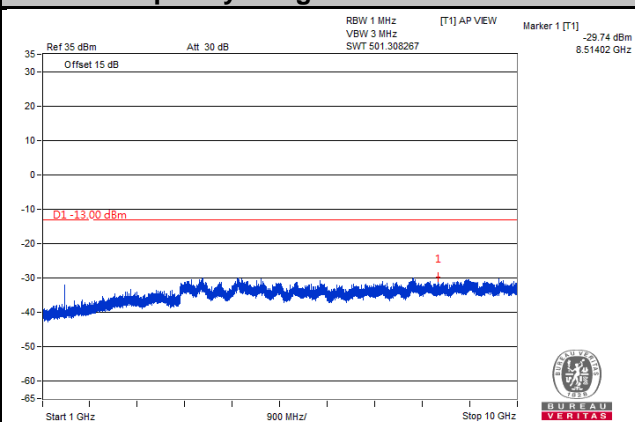

### Channel 23095

Frequency Range: 9 kHz ~ 1 GHz

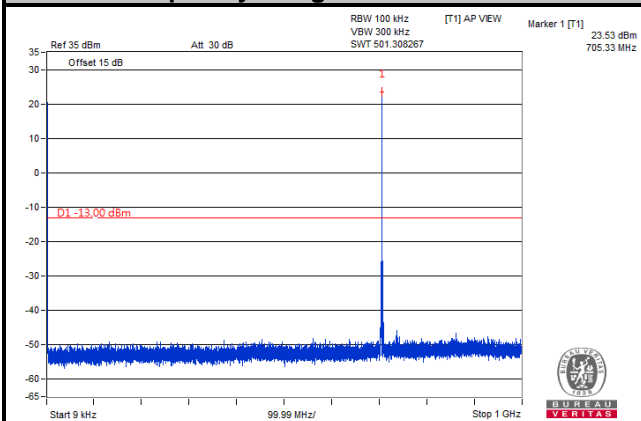

Frequency Range: 1 GHz ~ 10 GHz

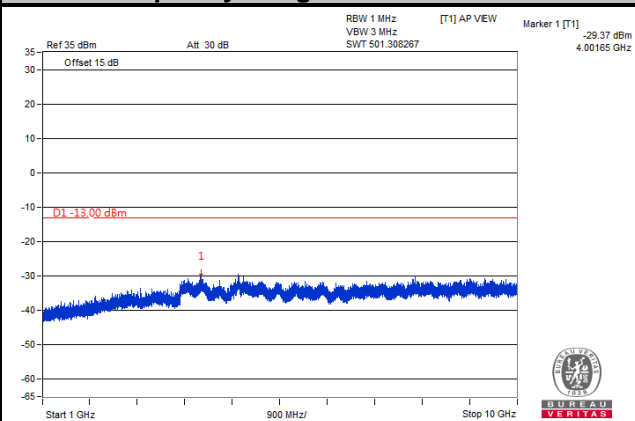

### Channel 23155

Frequency Range: 9 kHz ~ 1 GHz

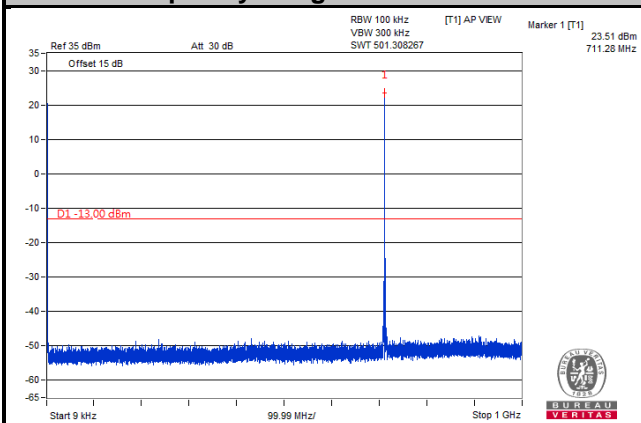

Frequency Range: 1 GHz ~ 10 GHz

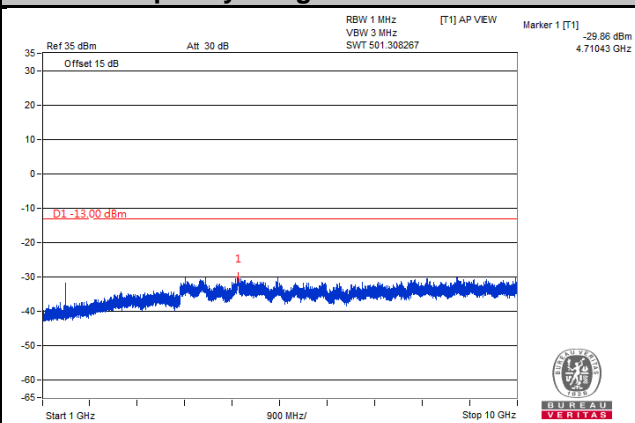

**LTE Band 12**  
**Channel Bandwidth: 10 MHz**

**Channel 23060**

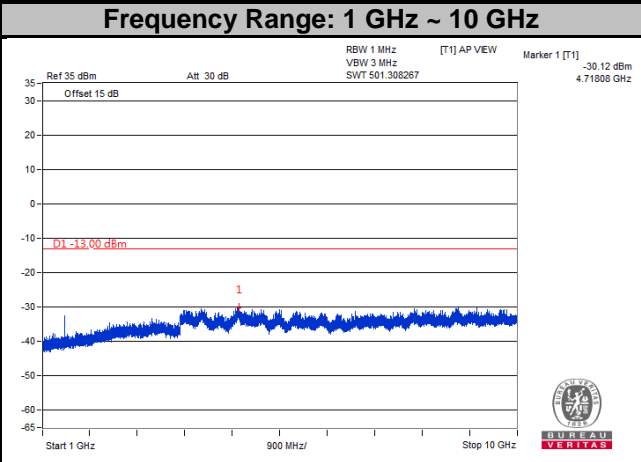
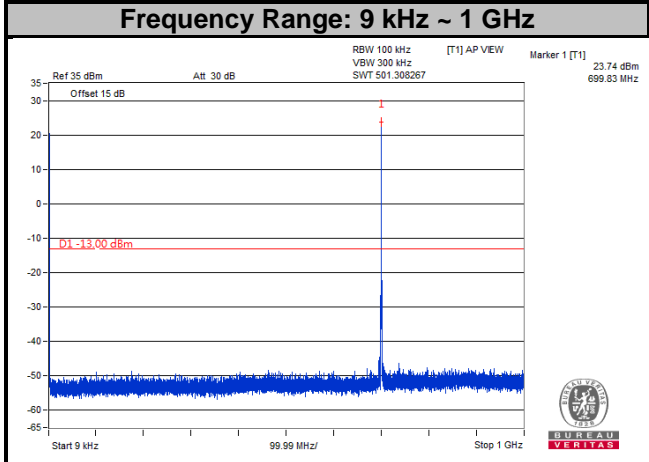

**Channel 23095**

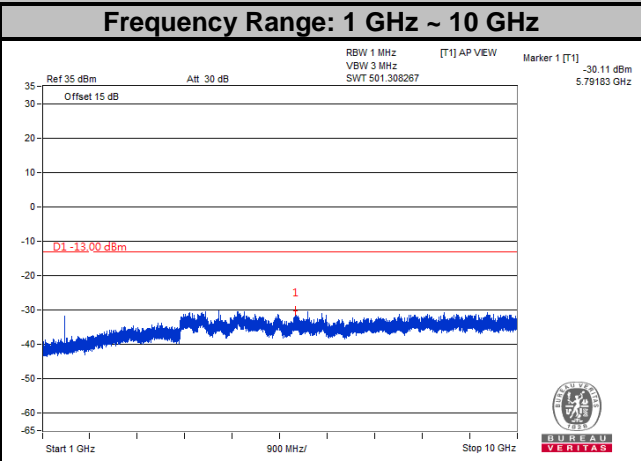
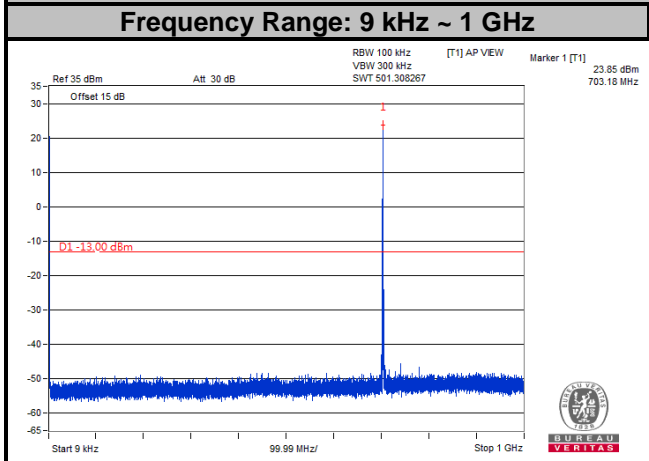

**Channel 23130**

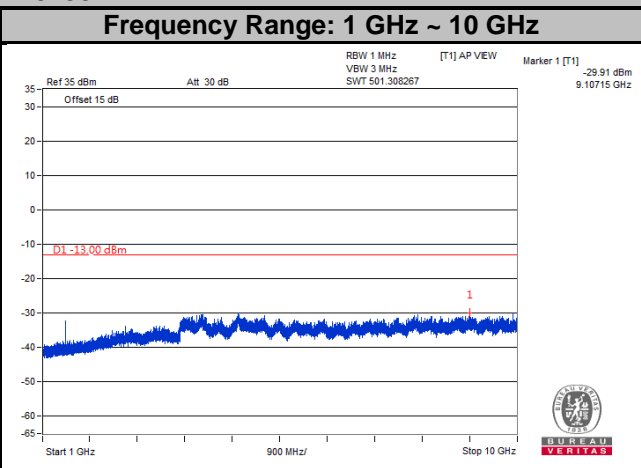
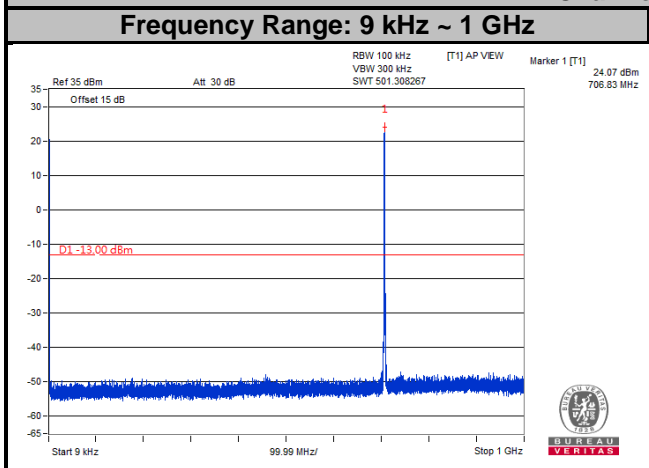



LTE Band 66

Channel Bandwidth: 5 MHz

Channel 131997

Frequency Range: 9 kHz ~ 1 GHz

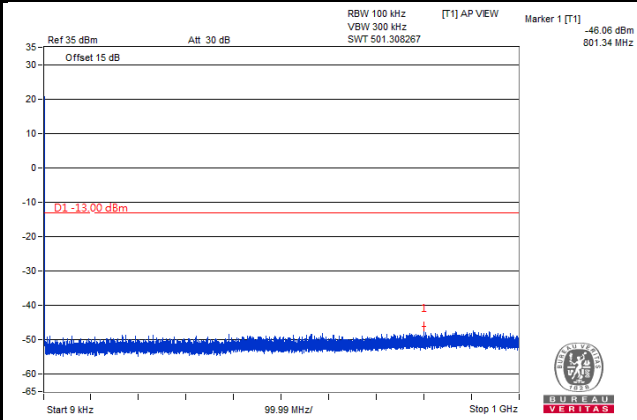

Frequency Range: 1 GHz ~ 10 GHz

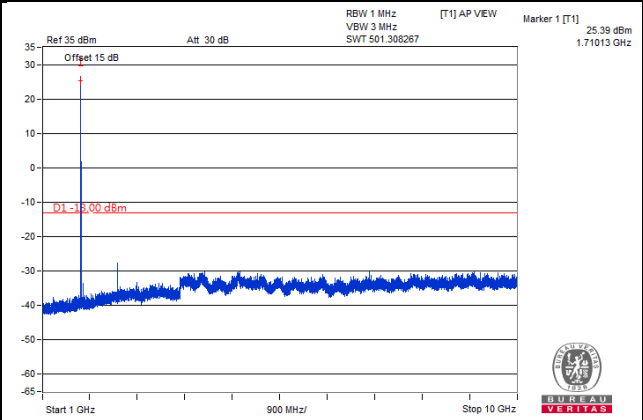

Frequency Range: 10 GHz ~ 27 GHz

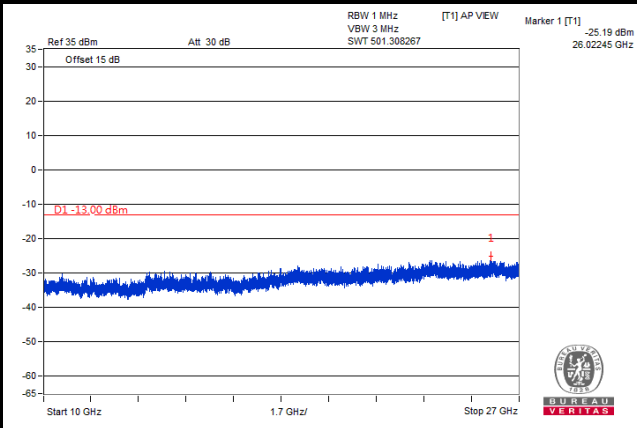

**LTE Band 66**

**Channel Bandwidth: 5 MHz**

**Channel 132322**

**Frequency Range: 9 kHz ~ 1 GHz**

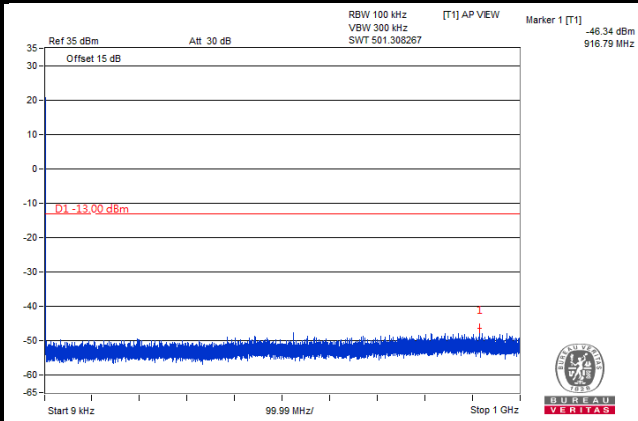

**Frequency Range: 1 GHz ~ 10 GHz**

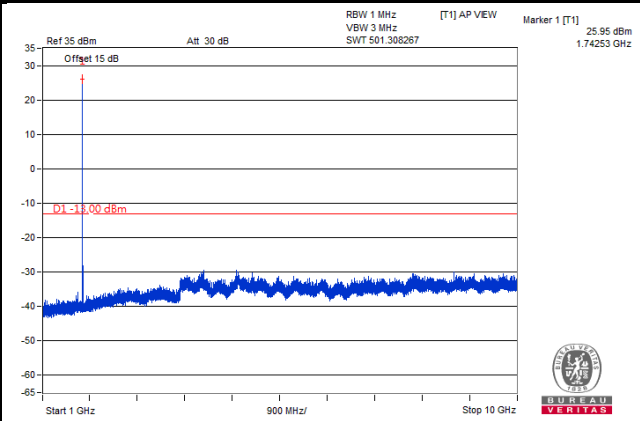

**Frequency Range: 10 GHz ~ 27 GHz**

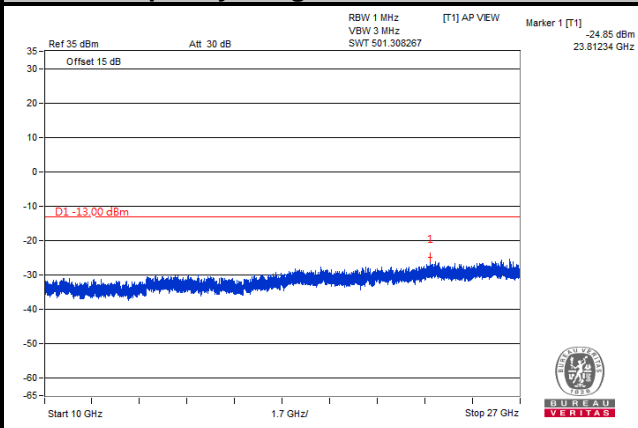

**LTE Band 66**

**Channel Bandwidth: 5 MHz**

**Channel 132647**

**Frequency Range: 9 kHz ~ 1 GHz**

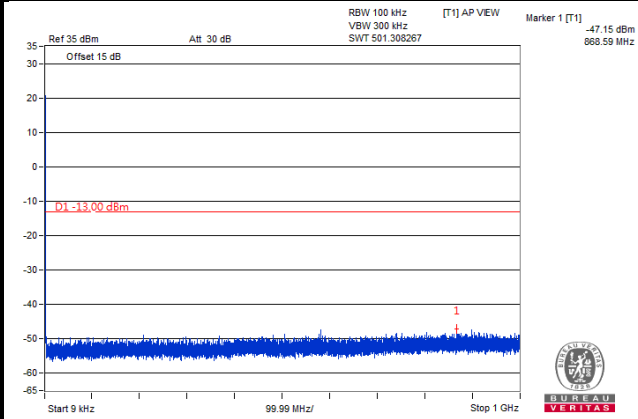

**Frequency Range: 1 GHz ~ 10 GHz**

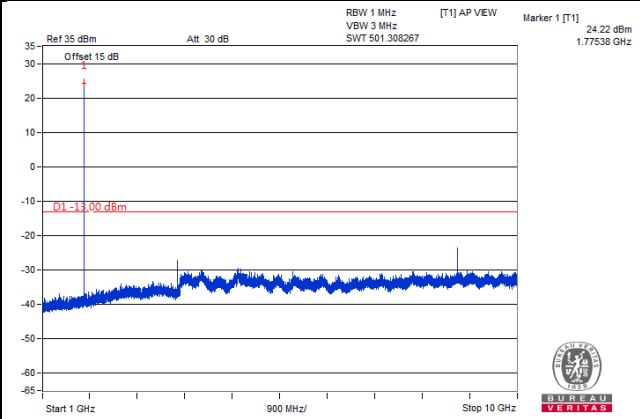

**Frequency Range: 10 GHz ~ 27 GHz**

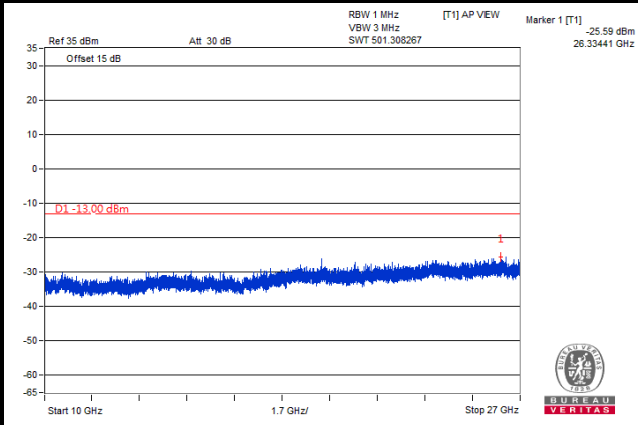

**LTE Band 66**  
**Channel Bandwidth: 10 MHz**  
**Channel 132022**

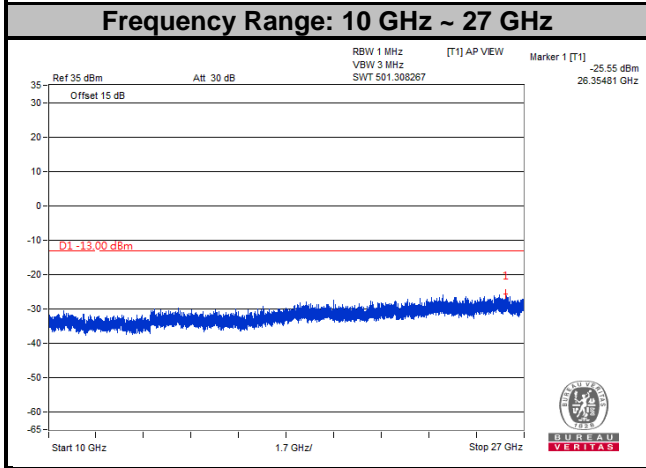
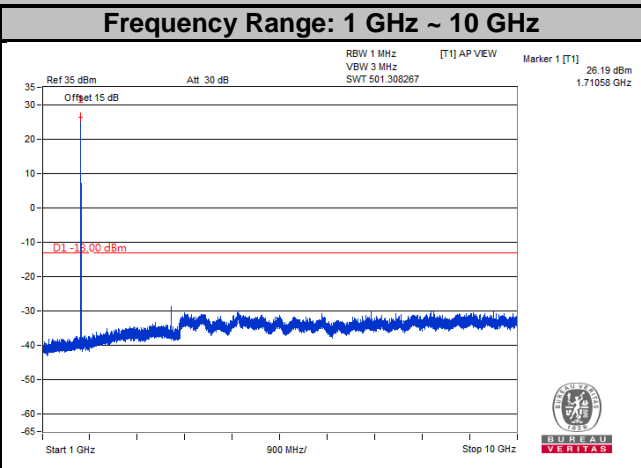
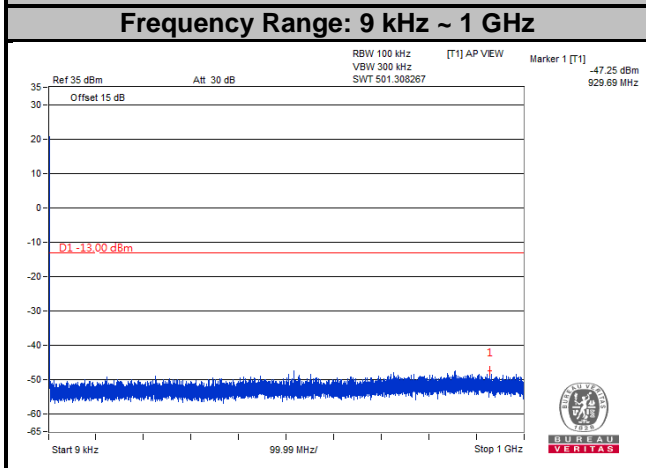

**LTE Band 66**

**Channel Bandwidth: 10 MHz**

**Channel 132322**

**Frequency Range: 9 kHz ~ 1 GHz**

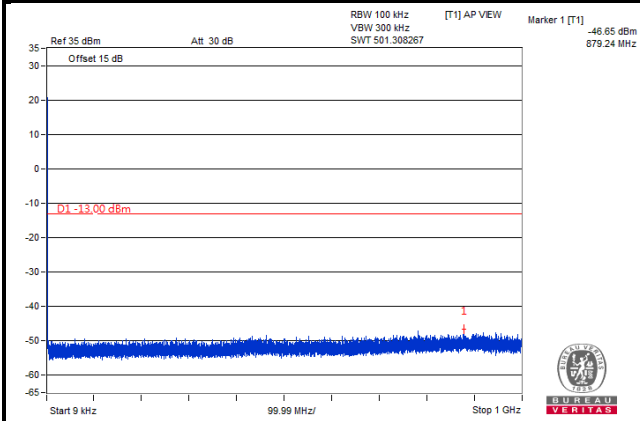

**Frequency Range: 1 GHz ~ 10 GHz**

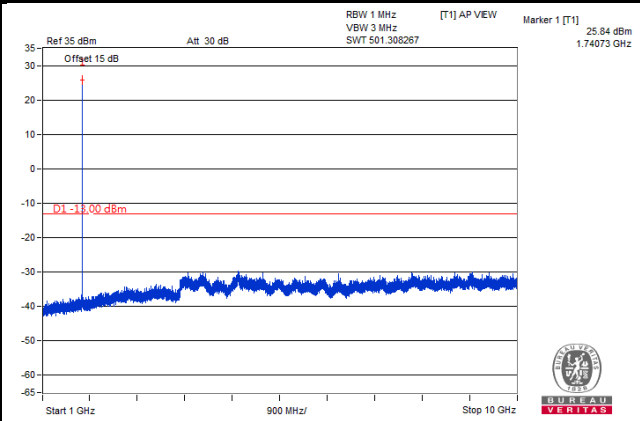

**Frequency Range: 10 GHz ~ 27 GHz**

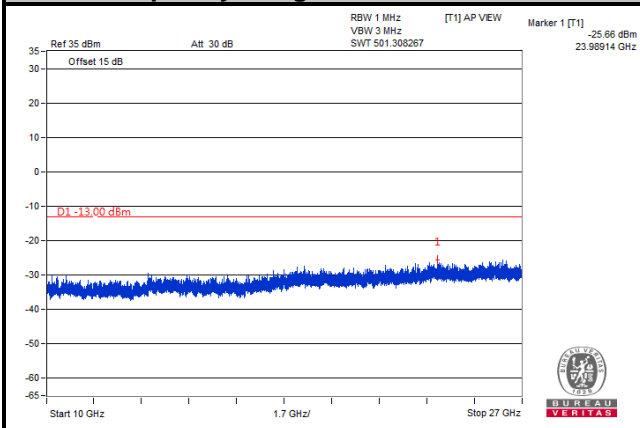

**LTE Band 66**

**Channel Bandwidth: 10 MHz**

**Channel 132622**

**Frequency Range: 9 kHz ~ 1 GHz**

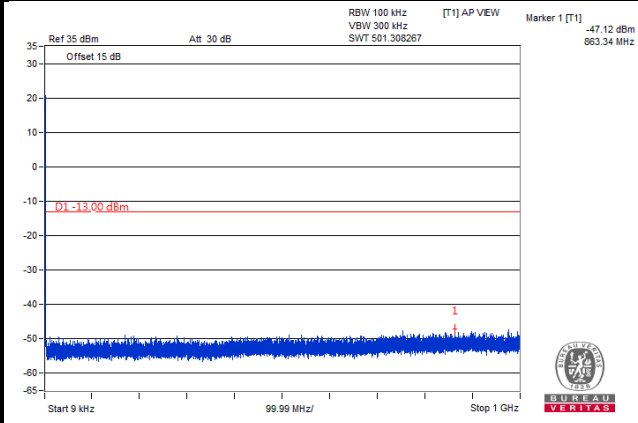

**Frequency Range: 1 GHz ~ 10 GHz**

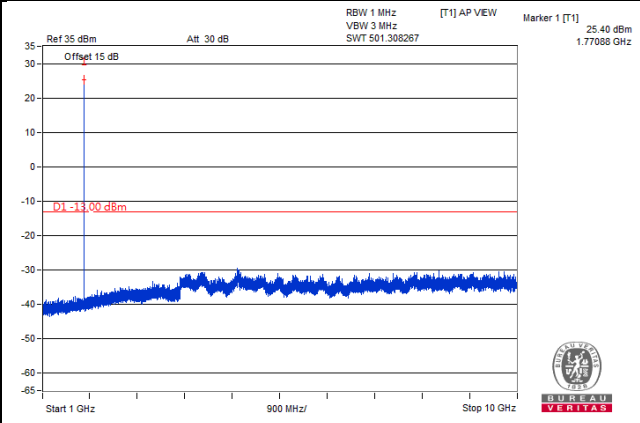

**Frequency Range: 10 GHz ~ 27 GHz**

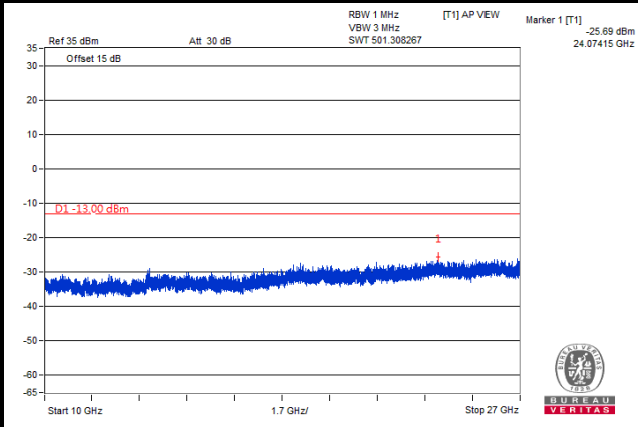

### LTE Band 66

Channel Bandwidth: 15 MHz

Channel 132047

#### Frequency Range: 9 kHz ~ 1 GHz

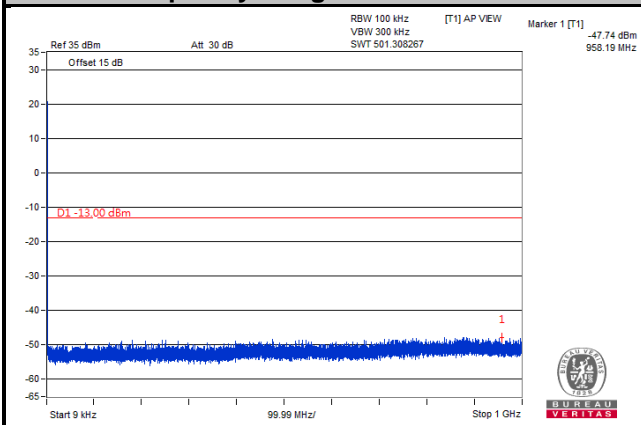

#### Frequency Range: 1 GHz ~ 10 GHz

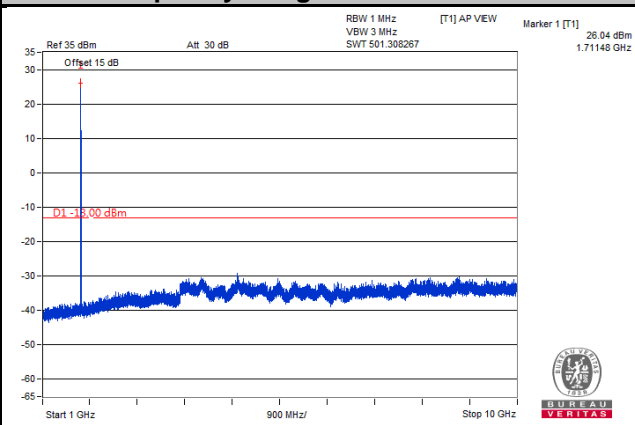

#### Frequency Range: 10 GHz ~ 27 GHz

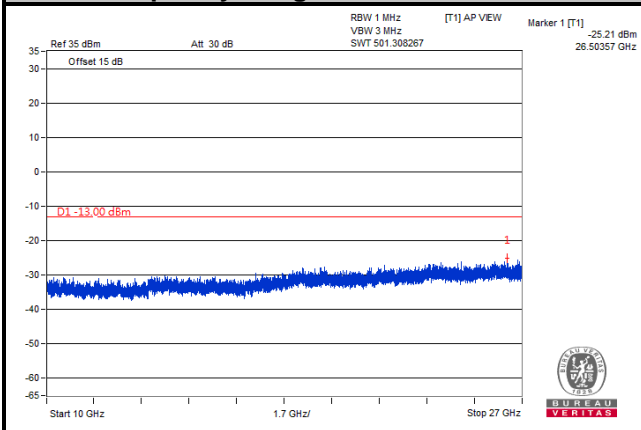

### LTE Band 66

Channel Bandwidth: 15 MHz

Channel 132322

#### Frequency Range: 9 kHz ~ 1 GHz

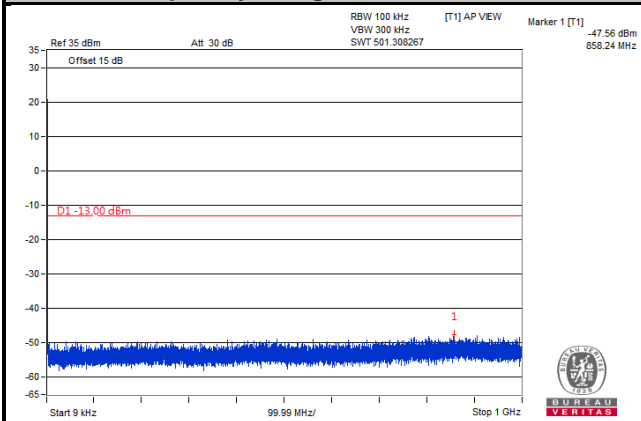

#### Frequency Range: 1 GHz ~ 10 GHz

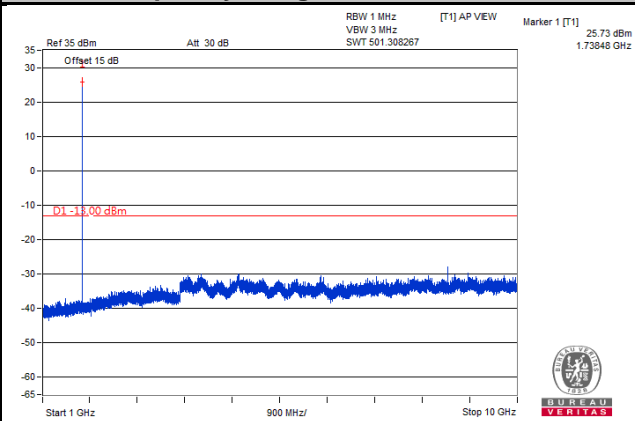

#### Frequency Range: 10 GHz ~ 27 GHz

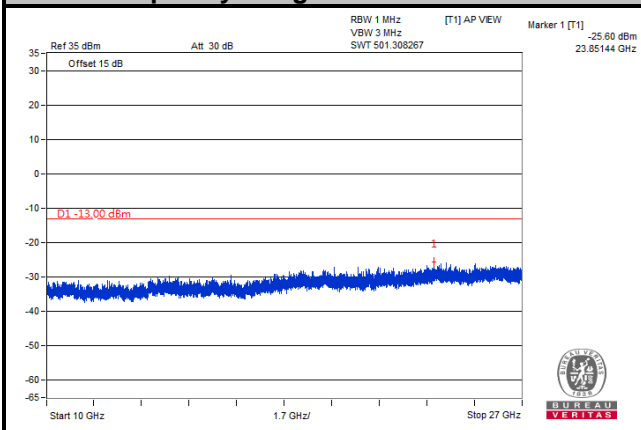



**LTE Band 66**

**Channel Bandwidth: 15 MHz**

**Channel 132597**

**Frequency Range: 9 kHz ~ 1 GHz**

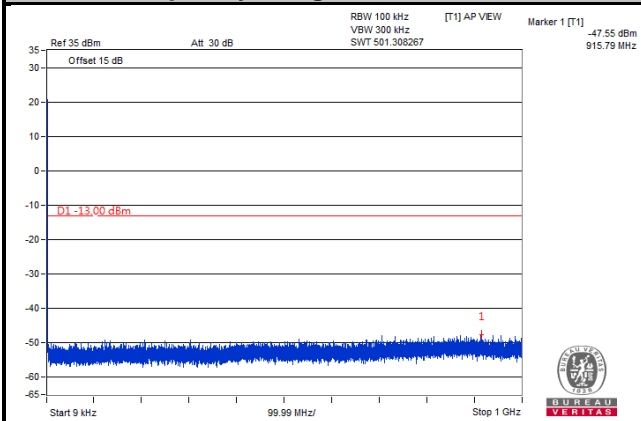

**Frequency Range: 1 GHz ~ 10 GHz**

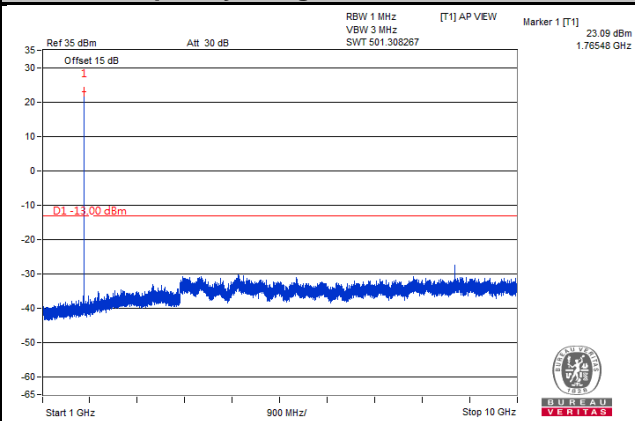

**Frequency Range: 10 GHz ~ 27 GHz**

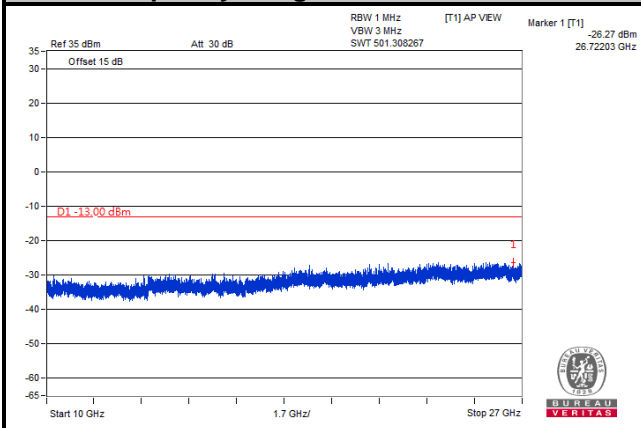

**LTE Band 66**  
**Channel Bandwidth: 20 MHz**  
**Channel 132072**

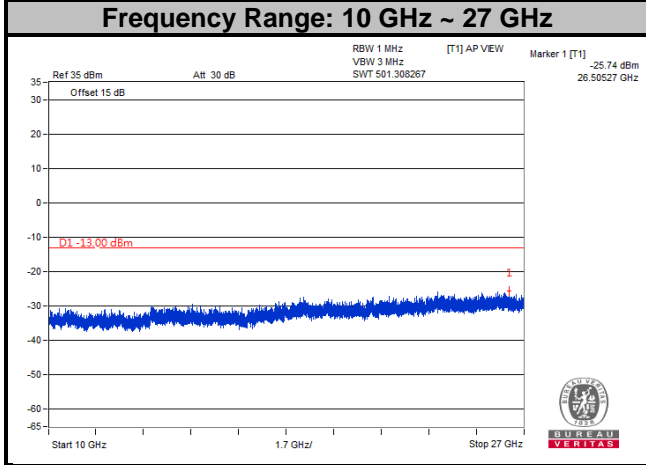
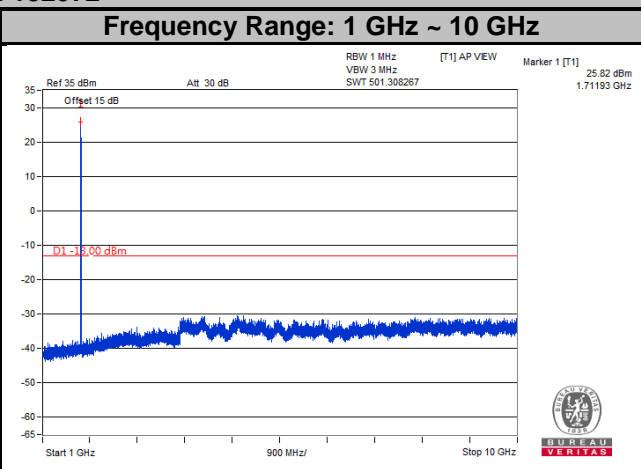
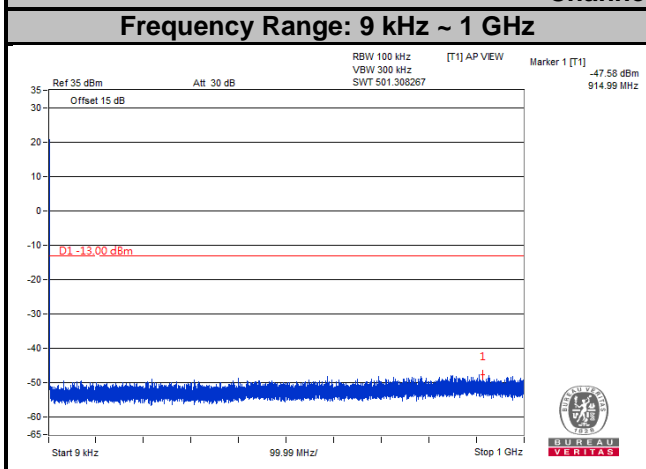

**LTE Band 66**  
**Channel Bandwidth: 20 MHz**  
**Channel 132322**

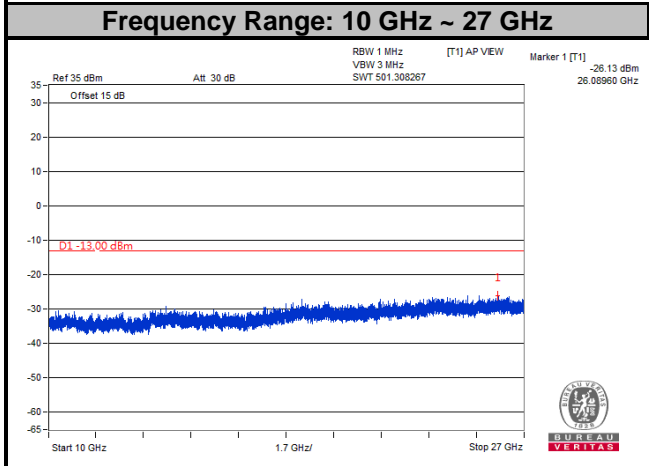
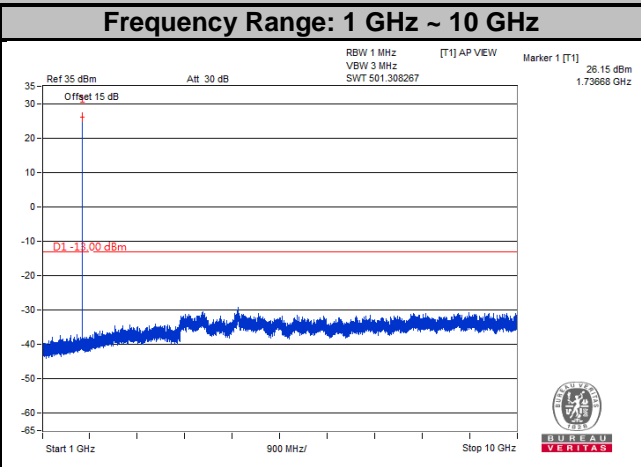
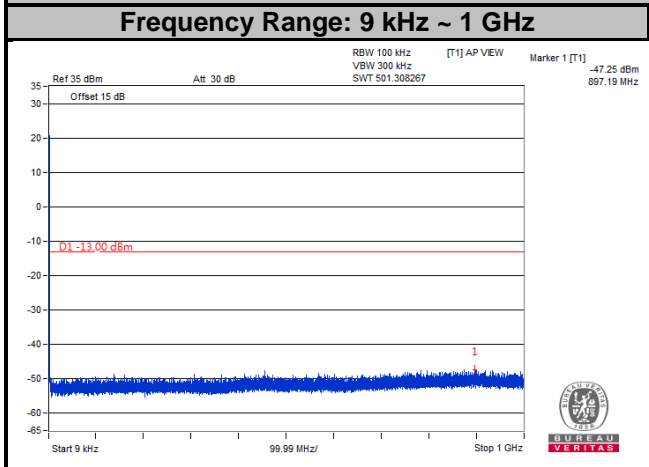

**LTE Band 66**  
**Channel Bandwidth: 20 MHz**  
**Channel 132572**

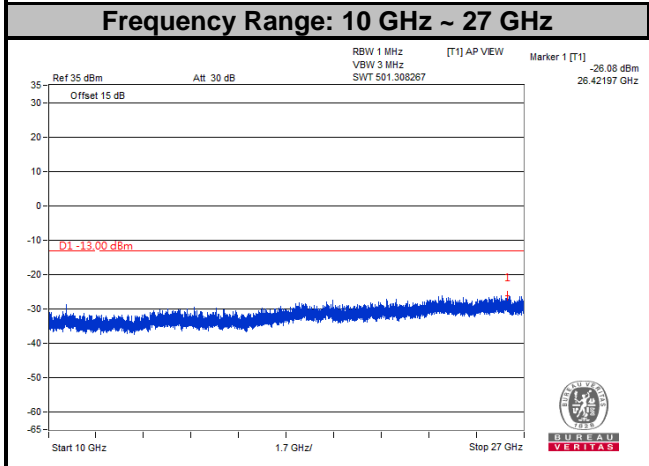
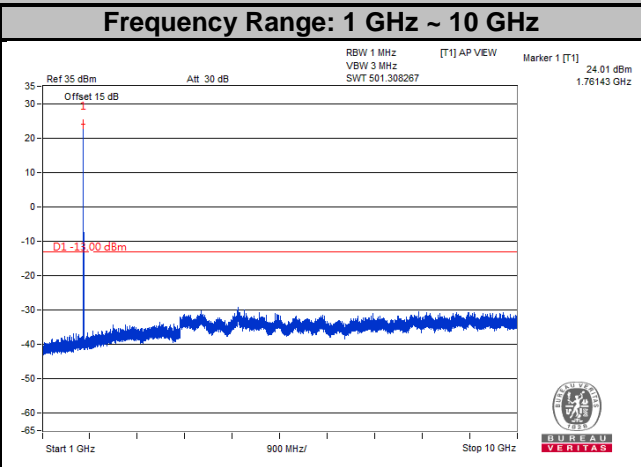
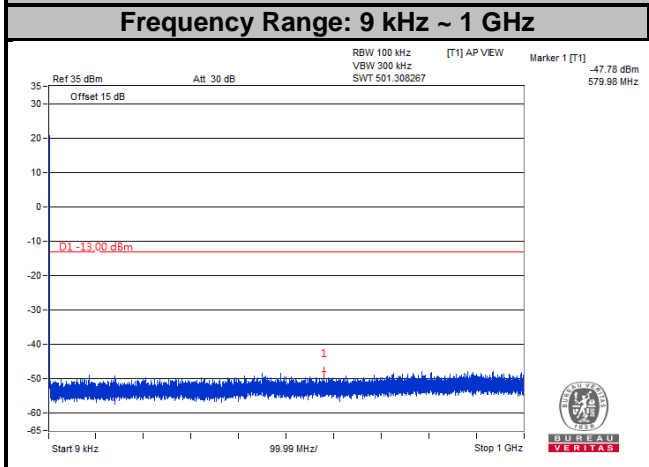

## 4.8 Radiated Emission Measurement

### 4.8.1 Limits of Radiated Emission Measurement

- a. The power of any emission outside a licensee's frequency block shall be attenuated below the transmitter power (P) by at least  $43 + 10 \log (P)$  dB. The limit of emission is equal to -13 dBm.

### 4.8.2 Test Procedure

- a. Substitution method is used for E.I.R.P measurement. In the semi-anechoic chamber, EUT placed on the 0.8 m (below or equal 1 GHz) and/or 1.5 m (above 1 GHz) height of Turn Table, rotated the table around 360 degrees to search the maximum radiation power and receiver antenna shall be rotated vertical and horizontal polarization and moved height from 1 m to 4 m to find the maximum polar radiated power. The "Read Value" is the spectrum reading the maximum power value.
- b. The substitution horn antenna is substituted for EUT at the same position and signals generator export the CW signal to the substitution antenna via a TX cable. Rotated the Turn Table and moved receiving antenna to find the maximum radiation power. Adjust output power level of S.G to get a Value of spectrum reading equal to "Read Value" of step a. Record the power level of S.G.
- c.  $EIRP = \text{Output power level of S.G} - \text{TX cable loss} + \text{Antenna gain of substitution horn}$ .
- d. E.R.P power can be calculated form E.I.R.P power by subtracting the gain of dipole,  $E.R.P \text{ power} = E.I.R.P \text{ power} - 2.15 \text{ dB}$ .

**Note:** The resolution bandwidth of spectrum analyzer is 1 MHz and the video bandwidth is 3 MHz.

### 4.8.3 Deviation from Test Standard

No deviation.

4.8.4 Test Setup

<Radiated Emission below or equal 1 GHz>

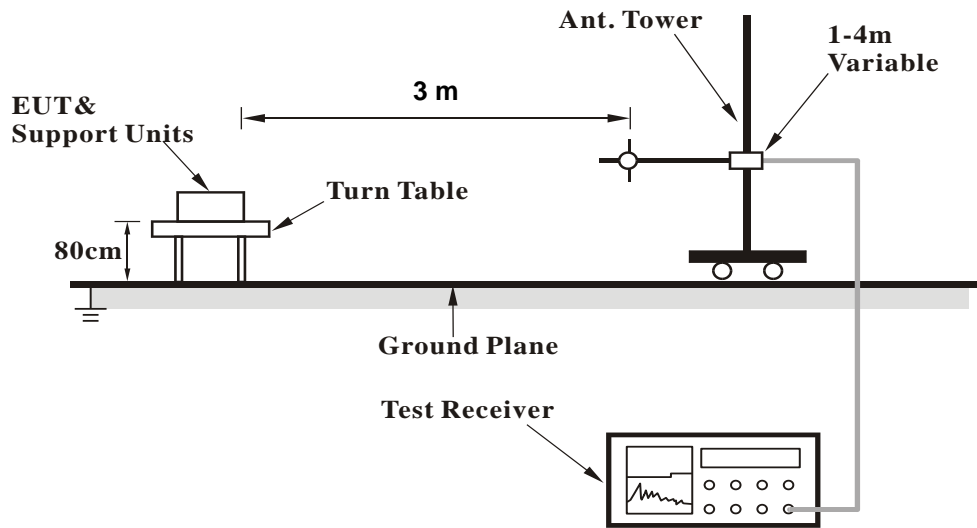

<Radiated Emission above 1 GHz>

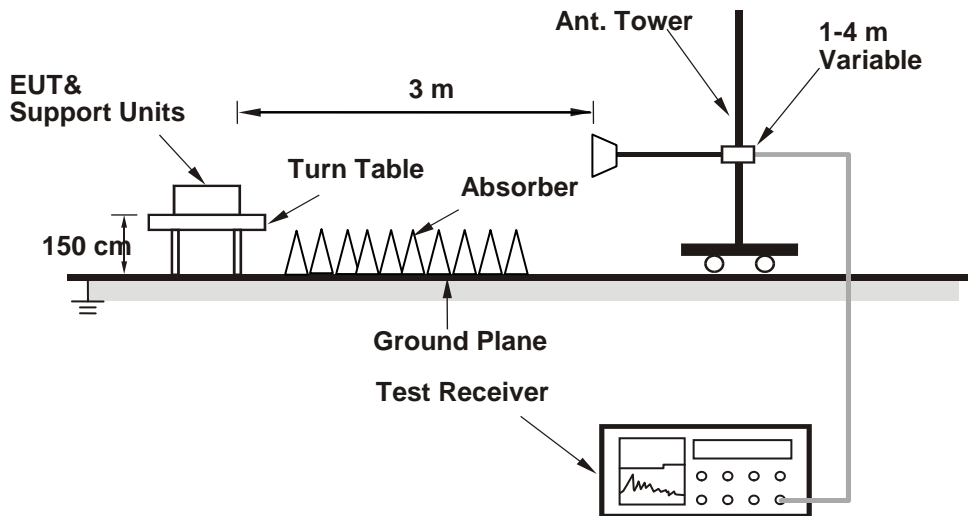

For the actual test configuration, please refer to the attached file (Test Setup Photo).

4.8.5 Test Results

LTE Band 4

Channel Bandwidth: 5 MHz / QPSK

Low Channel



Bureau Veritas Consumer Products Services Ltd., Taoyuan Branch

A D T

Data: 1

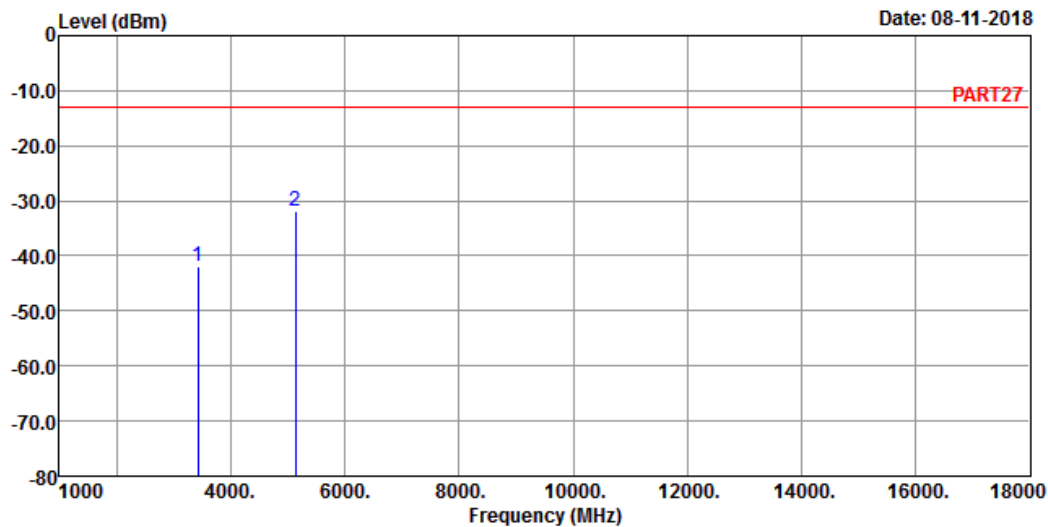

Site : 966 Chamber 5  
 Condition: PART27 HORIZONTAL  
 Remak : Cat-M1 Band 4 QPSK\_5M Link\_L-CH  
 Tested by: Thomas Wei

	Freq	Level	Read Level	Limit Line	Over Limit	Factor	Remark
	MHz	dBm	dBm	dBm	dB	dB	
1	3425.00	-41.89	-33.55	-13.00	-28.89	-8.34	Peak
2 pp	5137.50	-31.92	-30.18	-13.00	-18.92	-1.74	Peak



Bureau Veritas Consumer Products Services Ltd., Taoyuan Branch

A D T

Data: 2

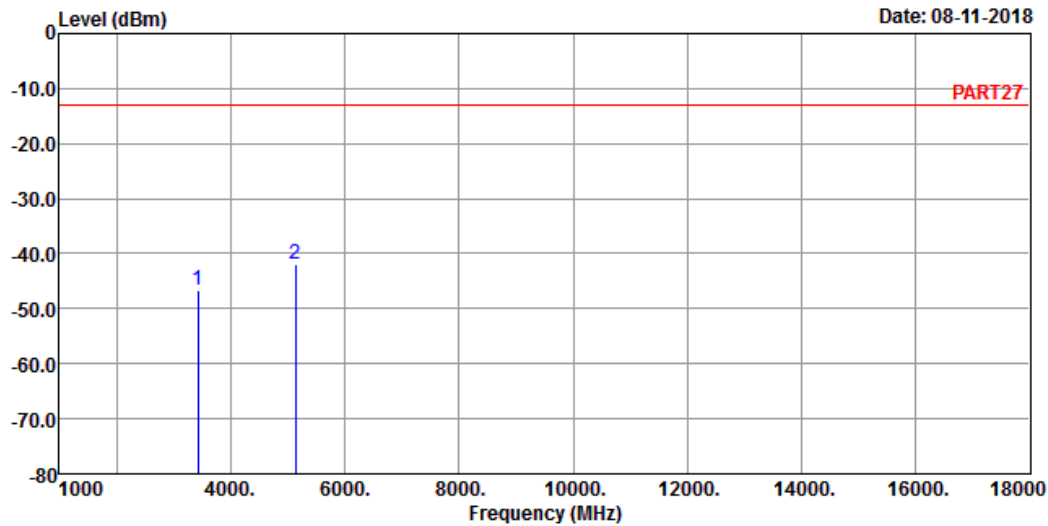

Site : 966 Chamber 5  
 Condition: PART27 VERTICAL  
 Remak : Cat-M1 Band 4 QPSK\_5M Link\_L-CH  
 Tested by: Thomas Wei

	Freq	Level	Read Level	Limit Line	Over Limit	Factor	Remark
	MHz	dBm	dBm	dBm	dB	dB	
1	3425.00	-46.74	-38.40	-13.00	-33.74	-8.34	Peak
2 pp	5137.50	-42.02	-40.28	-13.00	-29.02	-1.74	Peak



Middle Channel



Bureau Veritas Consumer Products Services Ltd., Taoyuan Branch

A D T

Data: 5

Date: 08-11-2018

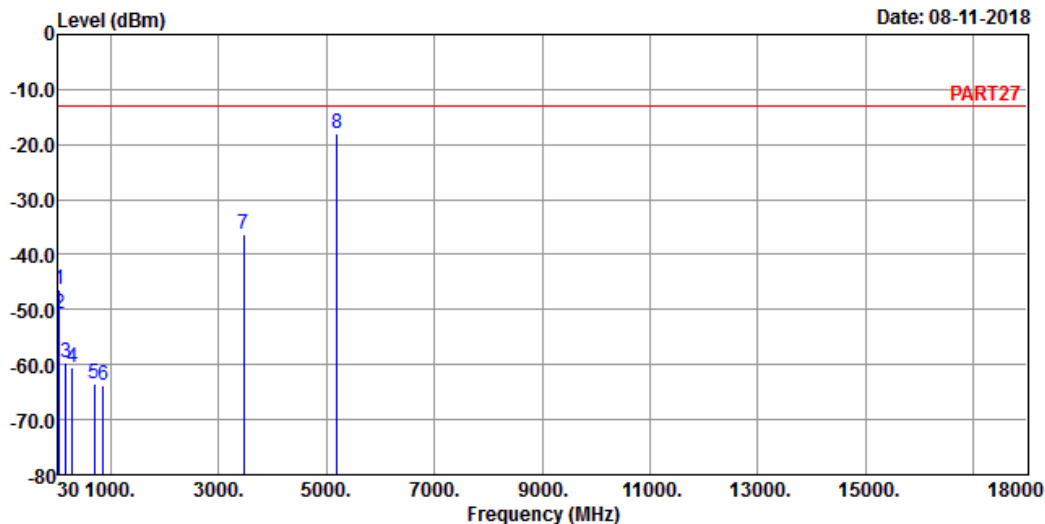

Site : 966 Chamber 5  
 Condition: PART27 HORIZONTAL  
 Remak : Cat-M1 Band 4 QPSK\_5M Link\_M-CH  
 Tested by: Thomas Wei

	Freq	Level	Read Level	Limit	Over	Factor	Remark
	MHz	dBm	dBm	dBm	dB	dB	
1	43.58	-46.29	-44.82	-13.00	-33.29	-1.47	Peak
2	53.28	-50.72	-44.91	-13.00	-37.72	-5.81	Peak
3	177.44	-59.75	-52.86	-13.00	-46.75	-6.89	Peak
4	293.84	-60.43	-53.54	-13.00	-47.43	-6.89	Peak
5	701.24	-63.41	-63.33	-13.00	-50.41	-0.08	Peak
6	857.41	-63.78	-64.11	-13.00	-50.78	0.33	Peak
7	3465.00	-36.41	-28.53	-13.00	-23.41	-7.88	Peak
8 pp	5197.00	-18.14	-16.07	-13.00	-5.14	-2.07	Peak



Bureau Veritas Consumer Products Services Ltd., Taoyuan Branch

A D T

Data: 6

Date: 08-11-2018

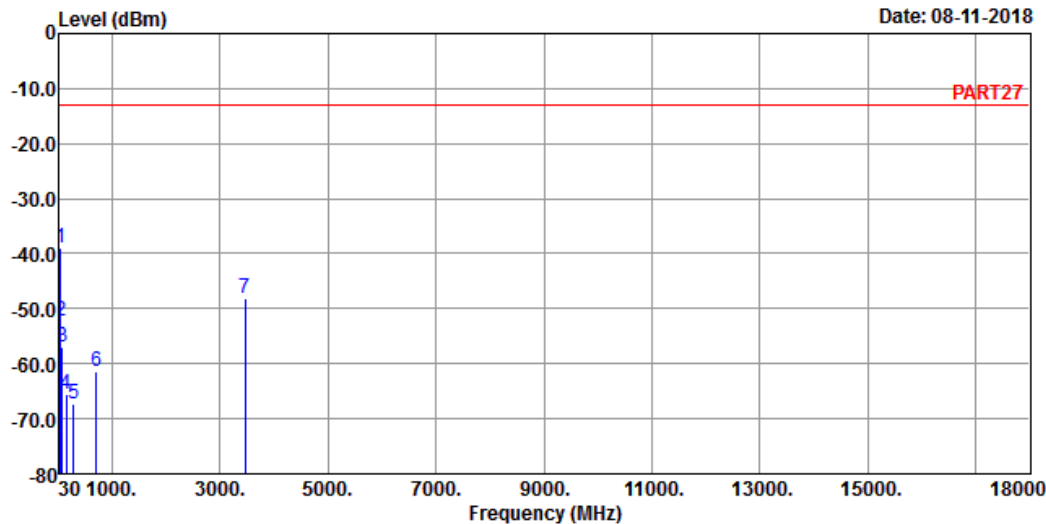

Site : 966 Chamber 5  
 Condition: PART27 VERTICAL  
 Remak : Cat-M1 Band 4 QPSK\_5M Link\_M-CH  
 Tested by: Thomas Wei

	Freq	Level	Read Level	Limit Line	Over Limit	Factor	Remark
	MHz	dBm	dBm	dBm	dB	dB	
1 pp	43.58	-38.93	-37.46	-13.00	-25.93	-1.47	Peak
2	53.28	-52.38	-46.57	-13.00	-39.38	-5.81	Peak
3	75.59	-57.04	-47.29	-13.00	-44.04	-9.75	Peak
4	161.92	-65.57	-60.59	-13.00	-52.57	-4.98	Peak
5	293.84	-67.34	-60.45	-13.00	-54.34	-6.89	Peak
6	717.73	-61.30	-61.55	-13.00	-48.30	0.25	Peak
7	3465.00	-48.20	-40.32	-13.00	-35.20	-7.88	Peak

High Channel



Bureau Veritas Consumer Products Services Ltd., Taoyuan Branch

A D T

Data: 1

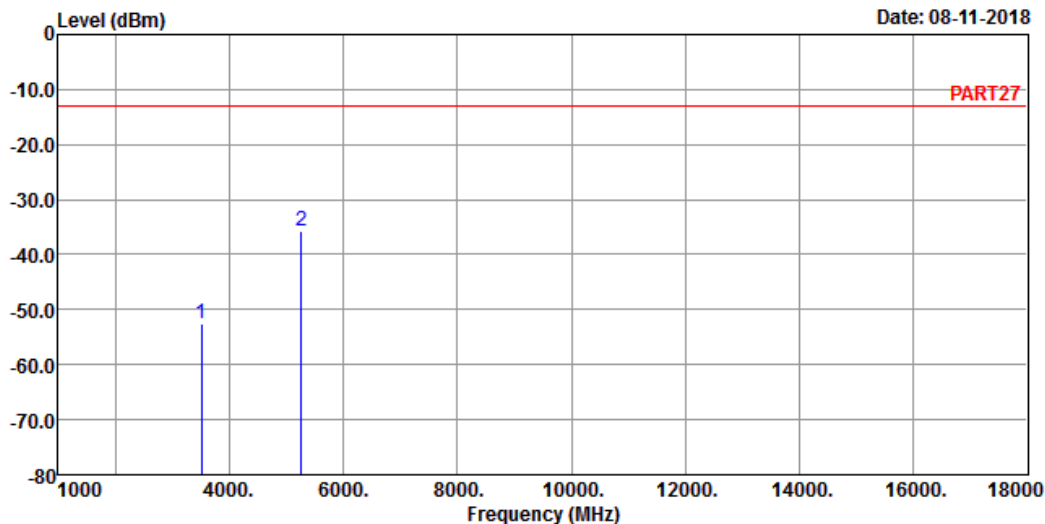

Site : 966 Chamber 5  
 Condition: PART27 HORIZONTAL  
 Remak : Cat-M1 Band 4 QPSK\_5M Link\_H-CH  
 Tested by: Thomas Wei

	Freq	Level	Read Level	Limit Line	Over Limit	Factor	Remark
	MHz	dBm	dBm	dBm	dB	dB	
1	3505.00	-52.59	-45.14	-13.00	-39.59	-7.45	Peak
2	5257.50	-35.58	-33.06	-13.00	-22.58	-2.52	Peak



Bureau Veritas Consumer Products Services Ltd., Taoyuan Branch

A D T

Data: 2

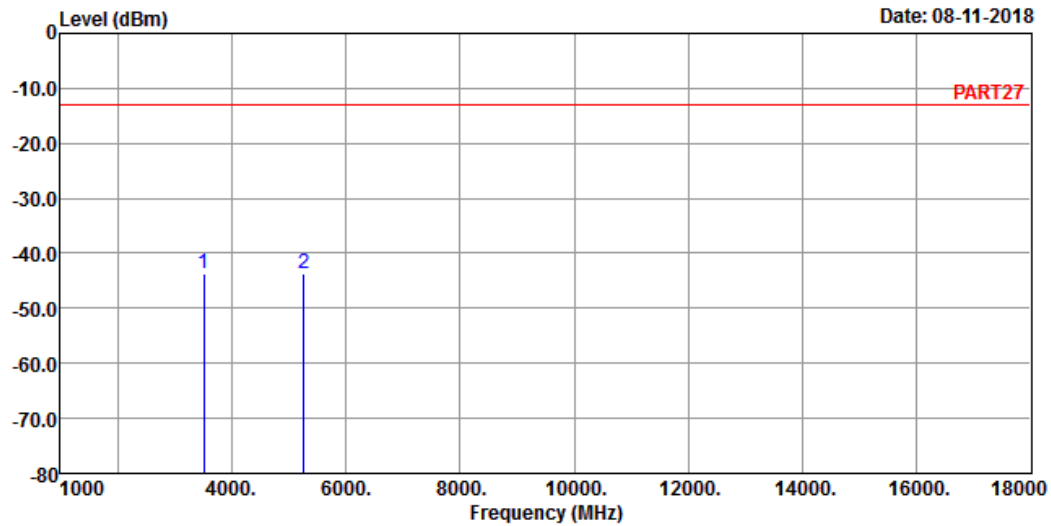

Site : 966 Chamber 5  
 Condition: PART27 VERTICAL  
 Remak : Cat-M1 Band 4 QPSK\_5M Link\_H-CH  
 Tested by: Thomas Wei

	Freq	Level	Read Level	Limit Line	Over Limit	Factor	Remark
	MHz	dBm	dBm	dBm	dB	dB	
1 pp	3505.00	-43.73	-36.28	-13.00	-30.73	-7.45	Peak
2	5257.50	-43.74	-41.22	-13.00	-30.74	-2.52	Peak

Channel Bandwidth: 20 MHz / QPSK  
Low Channel



Bureau Veritas Consumer Products Services Ltd., Taoyuan Branch

A D T

Data: 1

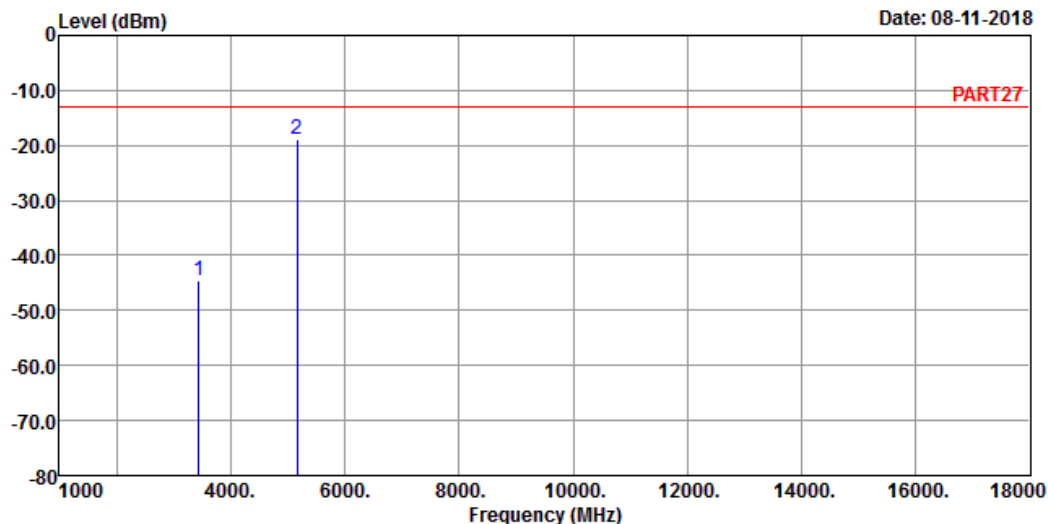

Site : 966 Chamber 5  
Condition: PART27 HORIZONTAL  
Remak : Cat-M1 Band 4 QPSK\_20M Link\_L-CH  
Tested by: Thomas Wei

	Freq	Level	Read Level	Limit Line	Over Limit	Factor	Remark
	MHz	dBm	dBm	dBm	dB	dB	
1	3440.00	-44.64	-36.42	-13.00	-31.64	-8.22	Peak
2 pp	5160.00	-18.97	-17.06	-13.00	-5.97	-1.91	Peak



Bureau Veritas Consumer Products Services Ltd., Taoyuan Branch

A D T

Data: 2

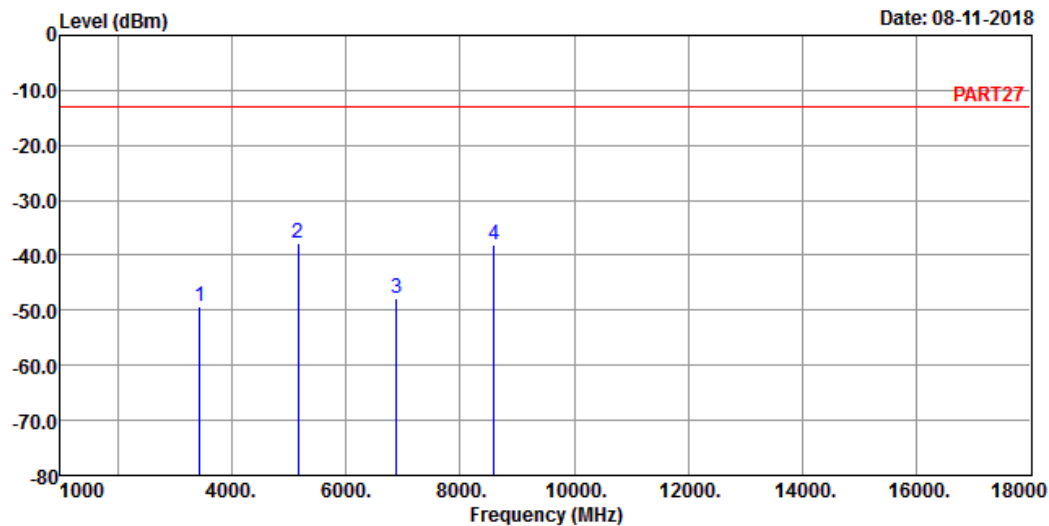

Site : 966 Chamber 5  
 Condition: PART27 VERTICAL  
 Remak : Cat-M1 Band 4 QPSK\_20M Link\_L-CH  
 Tested by: Thomas Wei

	Freq	Level	Read Level	Limit Line	Over Limit	Factor	Remark
	MHz	dBm	dBm	dBm	dB	dB	
1	3440.00	-49.18	-40.96	-13.00	-36.18	-8.22	Peak
2 pp	5160.00	-37.69	-35.78	-13.00	-24.69	-1.91	Peak
3	6880.00	-47.74	-50.22	-13.00	-34.74	2.48	Peak
4	8600.00	-38.07	-42.68	-13.00	-25.07	4.61	Peak

Middle Channel



Bureau Veritas Consumer Products Services Ltd., Taoyuan Branch

A D T

Data: 1

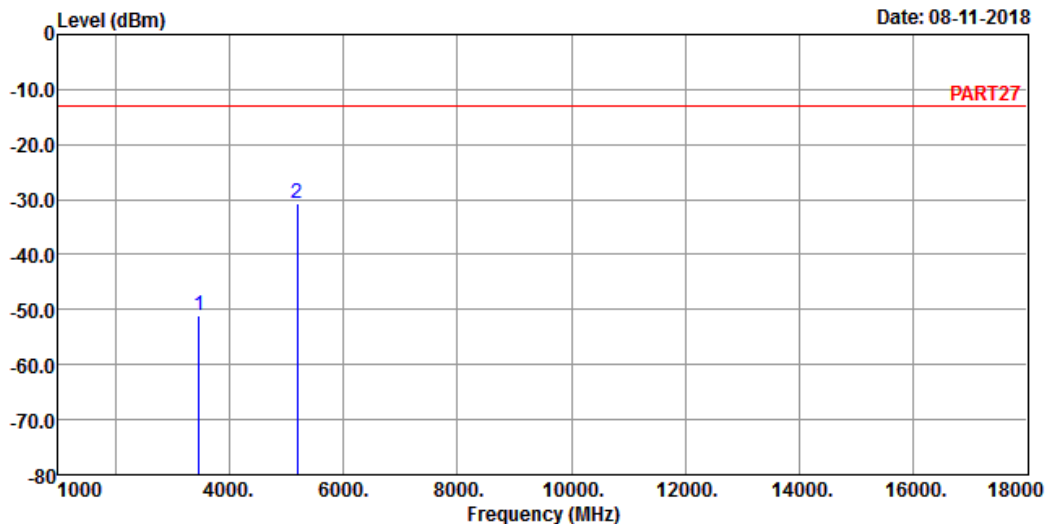

Site : 966 Chamber 5  
 Condition: PART27 HORIZONTAL  
 Remak : Cat-M1 Band 4 QPSK\_20M Link\_M-CH  
 Tested by: Thomas Wei

	Freq	Level	Read Level	Limit Line	Over Limit	Factor	Remark
	MHz	dBm	dBm	dBm	dB	dB	
1	3465.00	-51.13	-43.25	-13.00	-38.13	-7.88	Peak
2 pp	5197.50	-30.67	-28.60	-13.00	-17.67	-2.07	Peak



Bureau Veritas Consumer Products Services Ltd., Taoyuan Branch

A D T

Data: 2

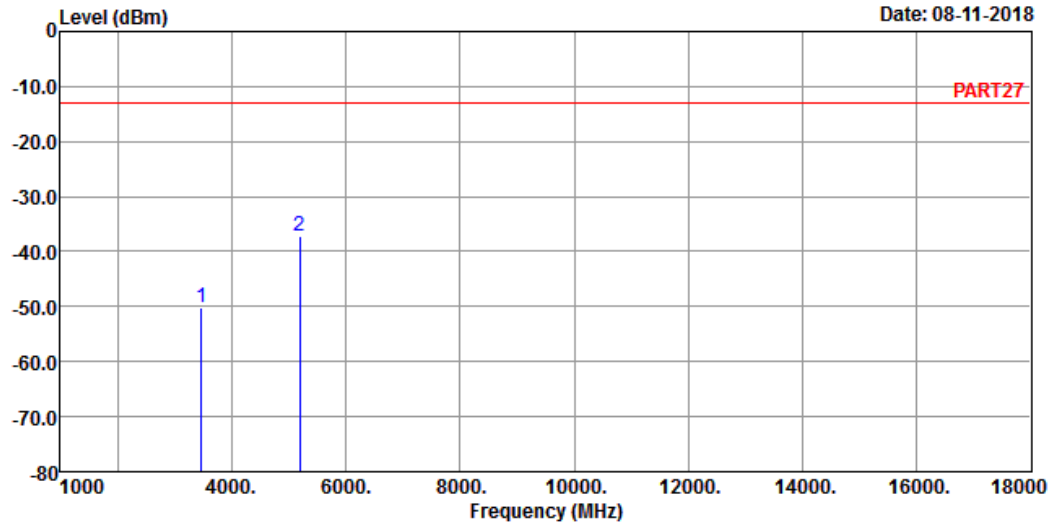

Site : 966 Chamber 5  
 Condition: PART27 VERTICAL  
 Remak : Cat-M1 Band 4 QPSK\_20M Link\_M-CH  
 Tested by: Thomas Wei

	Freq	Level	Read Level	Limit Line	Over Limit	Factor	Remark
	MHz	dBm	dBm	dBm	dB	dB	
1	3465.00	-50.09	-42.21	-13.00	-37.09	-7.88	Peak
2 pp	5197.50	-37.24	-35.17	-13.00	-24.24	-2.07	Peak



High Channel



Bureau Veritas Consumer Products Services Ltd., Taoyuan Branch

A D T

Data: 1

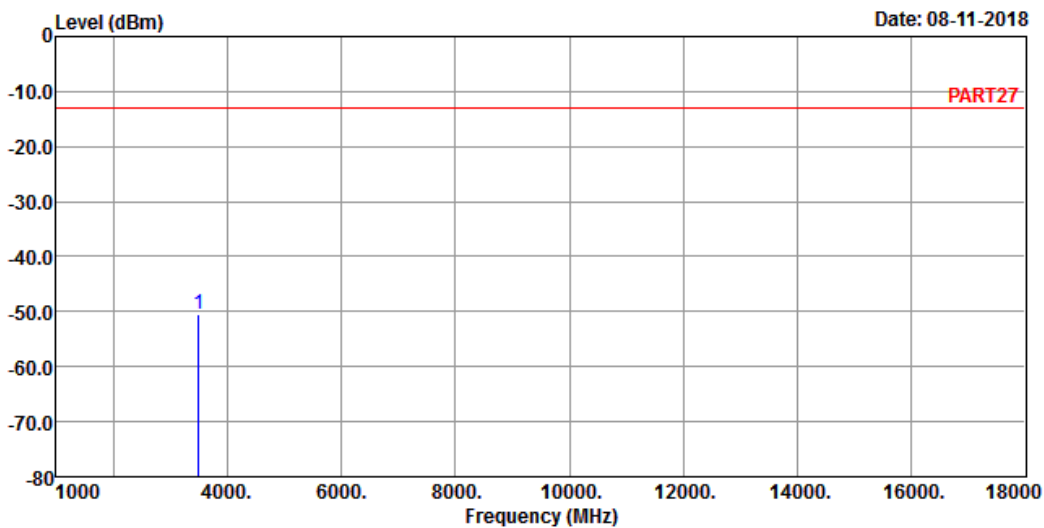

Site : 966 Chamber 5  
 Condition: PART27 HORIZONTAL  
 Remak : Cat-M1 Band 4 QPSK\_20M Link\_H-CH  
 Tested by: Thomas Wei

Freq	Level	Read Level	Limit	Over	Factor	Remark
MHz	dBm	dBm	dBm	dB	dB	

1 pp 3490.00 -50.54 -42.89 -13.00 -37.54 -7.65 Peak



Bureau Veritas Consumer Products Services Ltd., Taoyuan Branch

A D T

Data: 2

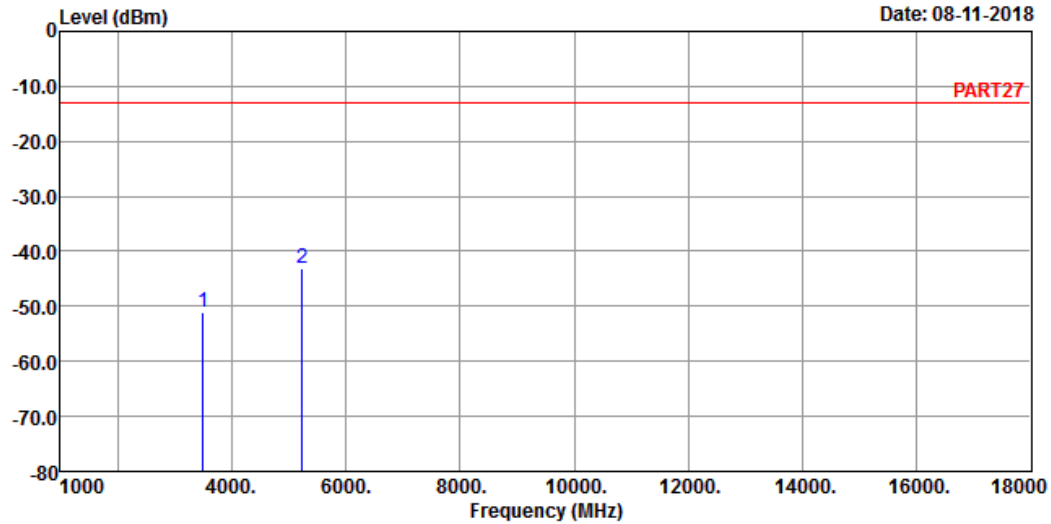

Site : 966 Chamber 5  
 Condition: PART27 VERTICAL  
 Remak : Cat-M1 Band 4 QPSK\_20M Link\_H-CH  
 Tested by: Thomas Wei

	Freq	Level	Read Level	Limit Line	Over Limit	Factor	Remark
	MHz	dBm	dBm	dBm	dB	dB	
1	3490.00	-51.14	-43.49	-13.00	-38.14	-7.65	Peak
2 pp	5235.00	-43.07	-40.66	-13.00	-30.07	-2.41	Peak

LTE Band 12  
 Channel Bandwidth: 5 MHz / QPSK  
 Low Channel



Bureau Veritas Consumer Products Services Ltd., Taoyuan Branch

A D T

Data: 1

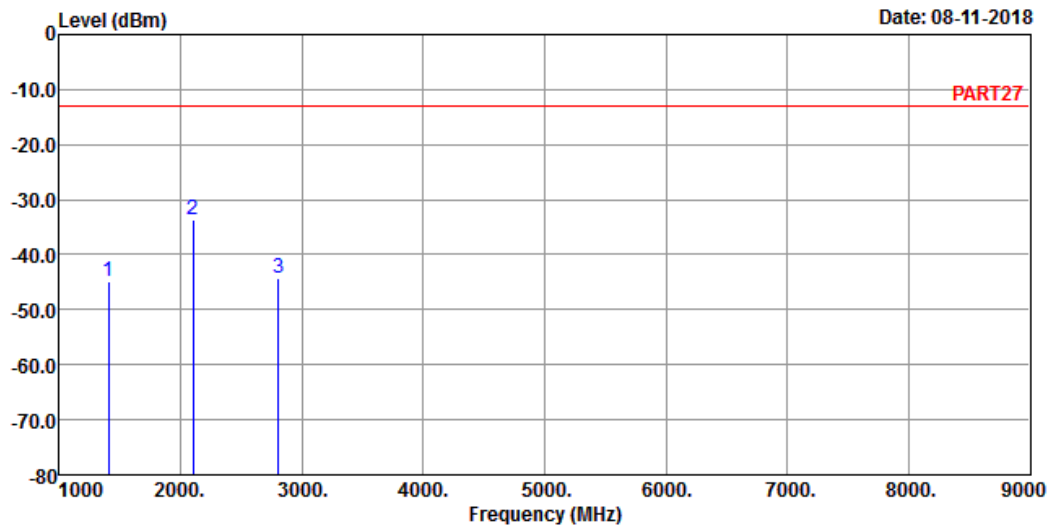

Site : 966 Chamber 5  
 Condition: PART27 HORIZONTAL  
 Remak : Cat-M1 Band 12 QPSK\_5M Link\_L-CH  
 Tested by: Thomas Wei

	Freq	Level	Read Level	Limit Line	Over Limit	Factor	Remark
	MHz	dBm	dBm	dBm	dB	dB	
1	1403.00	-44.92	-33.01	-13.00	-31.92	-11.91	Peak
2	2104.50	-33.63	-23.47	-13.00	-20.63	-10.16	Peak
3	2806.00	-44.33	-35.81	-13.00	-31.33	-8.52	Peak



Bureau Veritas Consumer Products Services Ltd., Taoyuan Branch

A D T

Data: 2

Date: 08-11-2018

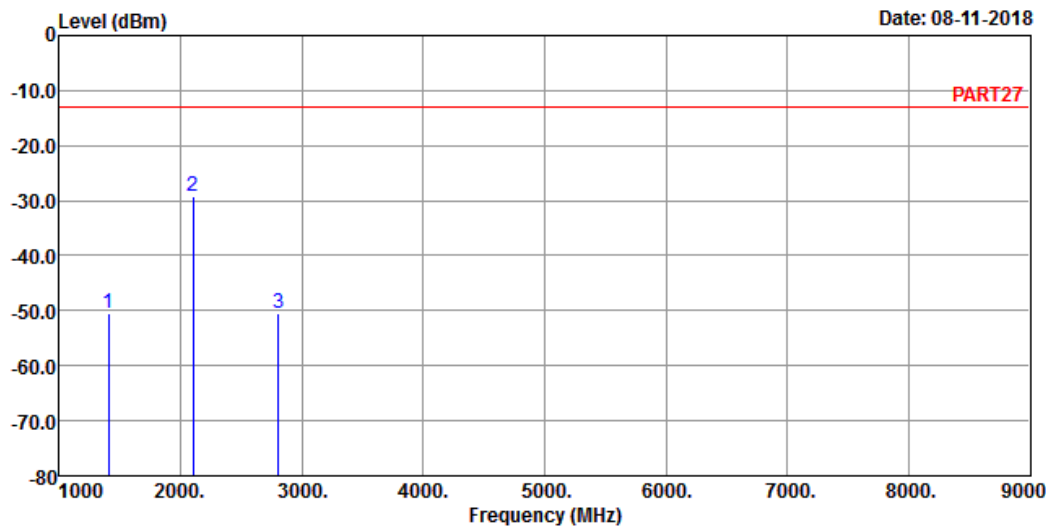

Site : 966 Chamber 5  
 Condition: PART27 VERTICAL  
 Remak : Cat-M1 Band 12 QPSK\_5M Link\_L-CH  
 Tested by: Thomas Wei

	Freq	Level	Read Level	Limit Line	Over Limit	Factor	Remark
	MHz	dBm	dBm	dBm	dB	dB	
1	1403.00	-50.49	-38.58	-13.00	-37.49	-11.91	Peak
2 pp	2104.50	-29.25	-19.09	-13.00	-16.25	-10.16	Peak
3	2806.00	-50.36	-41.84	-13.00	-37.36	-8.52	Peak

Middle Channel



Bureau Veritas Consumer Products Services Ltd., Taoyuan Branch

A D T

Data: 1

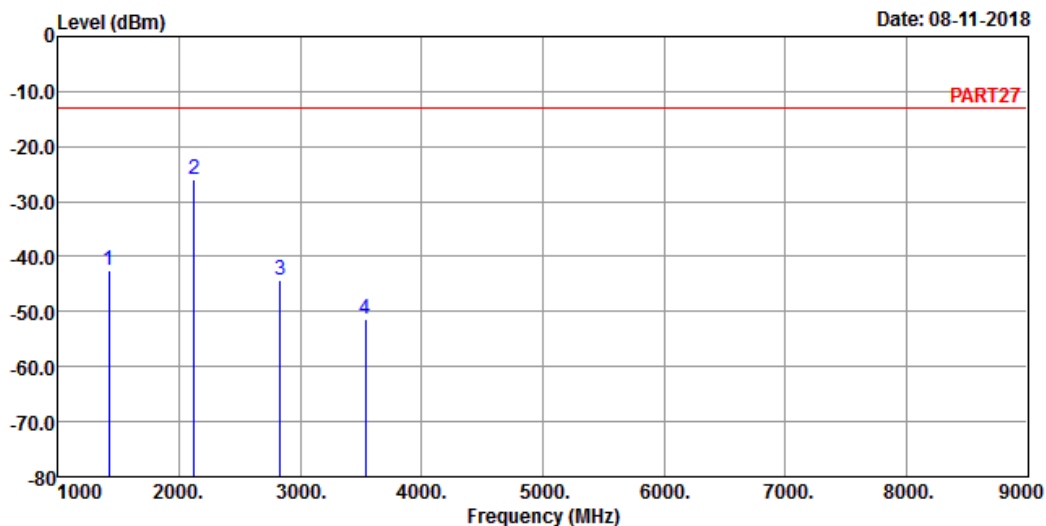

Site : 966 Chamber 5  
 Condition: PART27 HORIZONTAL  
 Remak : Cat-M1 Band 12 QPSK\_5M Link\_M-CH  
 Tested by: Thomas Wei

	Freq	Level	Read Level	Limit Line	Over Limit	Factor	Remark
	MHz	dBm	dBm	dBm	dB	dB	
1	1415.00	-42.47	-30.39	-13.00	-29.47	-12.08	Peak
2 pp	2122.50	-25.89	-16.02	-13.00	-12.89	-9.87	Peak
3	2830.00	-44.42	-35.94	-13.00	-31.42	-8.48	Peak
4	3537.50	-51.41	-44.19	-13.00	-38.41	-7.22	Peak



Bureau Veritas Consumer Products Services Ltd., Taoyuan Branch

A D T

Data: 2

Date: 08-11-2018

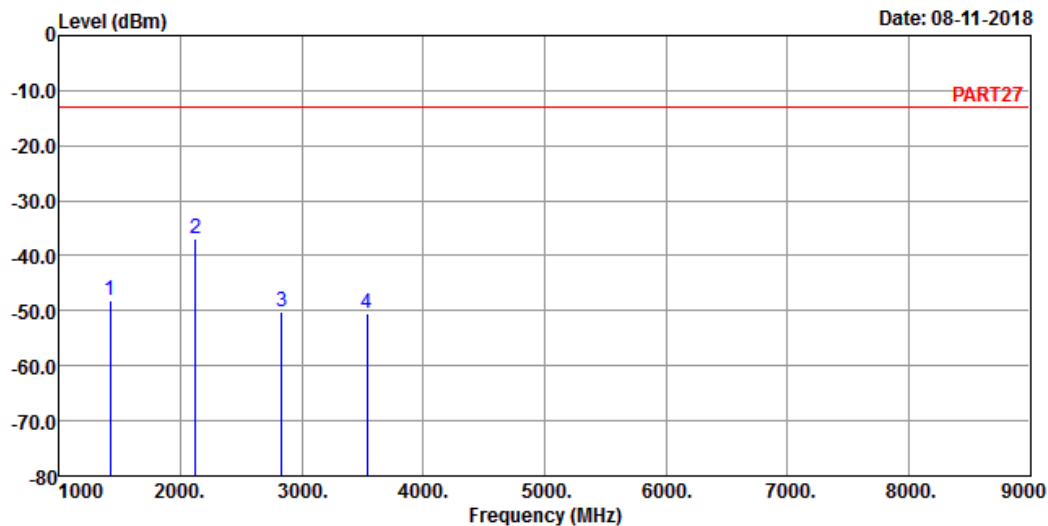

Site : 966 Chamber 5  
 Condition: PART27 VERTICAL  
 Remak : Cat-M1 Band 12 QPSK\_5M Link\_M-CH  
 Tested by: Thomas Wei

	Freq	Level	Read Level	Limit Line	Over Limit	Factor	Remark
	MHz	dBm	dBm	dBm	dB	dB	
1	1415.00	-48.04	-35.96	-13.00	-35.04	-12.08	Peak
2 pp	2122.50	-36.77	-26.90	-13.00	-23.77	-9.87	Peak
3	2830.00	-50.19	-41.71	-13.00	-37.19	-8.48	Peak
4	3537.50	-50.46	-43.24	-13.00	-37.46	-7.22	Peak

High Channel



Bureau Veritas Consumer Products Services Ltd., Taoyuan Branch

A D T

Data: 5

Date: 08-11-2018

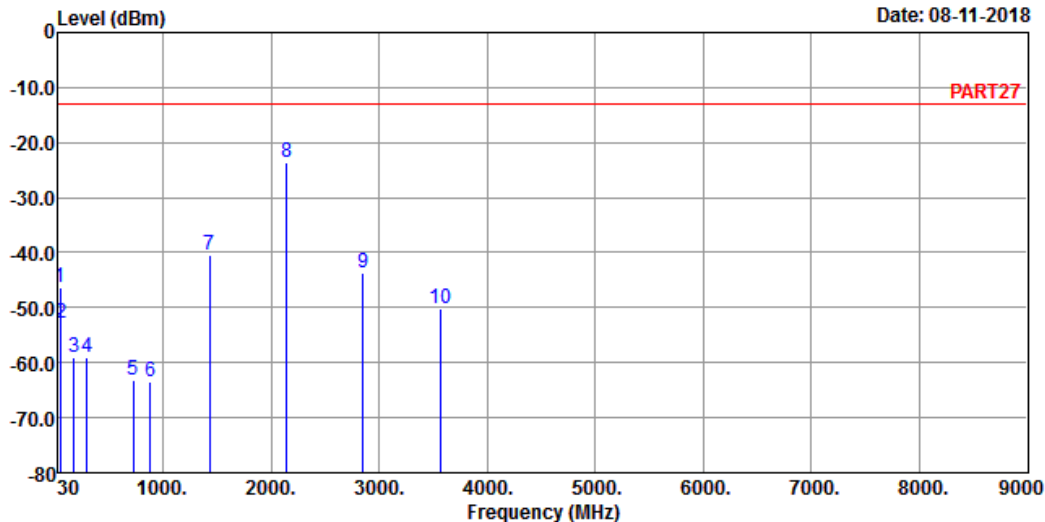

Site : 966 Chamber 5  
 Condition: PART27 HORIZONTAL  
 Remak : Cat-M1 Band 12 QPSK\_5M Link\_H-CH  
 Tested by: Thomas Wei

	Read	Limit	Over				
	Freq	Level	Level	Line	Limit	Factor	Remark
	MHz	dBm	dBm	dBm	dB	dB	
1	43.58	-46.22	-44.75	-13.00	-33.22	-1.47	Peak
2	53.28	-52.76	-46.95	-13.00	-39.76	-5.81	Peak
3	178.41	-59.11	-52.05	-13.00	-46.11	-7.06	Peak
4	292.87	-58.97	-52.10	-13.00	-45.97	-6.87	Peak
5	727.43	-63.15	-63.59	-13.00	-50.15	0.44	Peak
6	879.72	-63.33	-63.79	-13.00	-50.33	0.46	Peak
7	1427.00	-40.47	-28.22	-13.00	-27.47	-12.25	Peak
8 pp	2140.50	-23.61	-14.04	-13.00	-10.61	-9.57	Peak
9	2854.00	-43.74	-35.30	-13.00	-30.74	-8.44	Peak
10	3567.50	-50.19	-43.20	-13.00	-37.19	-6.99	Peak



Bureau Veritas Consumer Products Services Ltd., Taoyuan Branch

A D T

Data: 6

Date: 08-11-2018

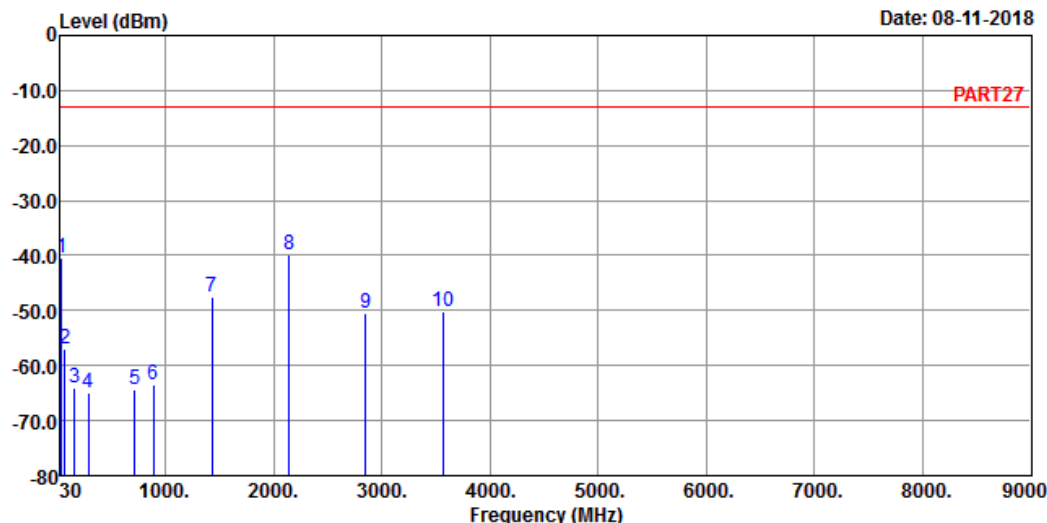

Site : 966 Chamber 5  
 Condition: PART27 VERTICAL  
 Remak : Cat-M1 Band 12 QPSK\_5M Link\_H-CH  
 Tested by: Thomas Wei

	Freq	Level	Read Level	Limit Line	Over Limit	Factor	Remark
	MHz	dBm	dBm	dBm	dB	dB	
1	39.70	-40.57	-41.21	-13.00	-27.57	0.64	Peak
2	70.74	-56.84	-48.22	-13.00	-43.84	-8.62	Peak
3	161.92	-64.12	-59.14	-13.00	-51.12	-4.98	Peak
4	290.93	-65.02	-58.19	-13.00	-52.02	-6.83	Peak
5	714.82	-64.45	-64.64	-13.00	-51.45	0.19	Peak
6	886.51	-63.54	-64.04	-13.00	-50.54	0.50	Peak
7	1427.00	-47.46	-35.21	-13.00	-34.46	-12.25	Peak
8 pp	2140.50	-39.81	-30.24	-13.00	-26.81	-9.57	Peak
9	2854.00	-50.43	-41.99	-13.00	-37.43	-8.44	Peak
10	3567.50	-50.12	-43.13	-13.00	-37.12	-6.99	Peak



Channel Bandwidth: 10 MHz / QPSK  
Low Channel



Bureau Veritas Consumer Products Services Ltd., Taoyuan Branch

A D T

Data: 1

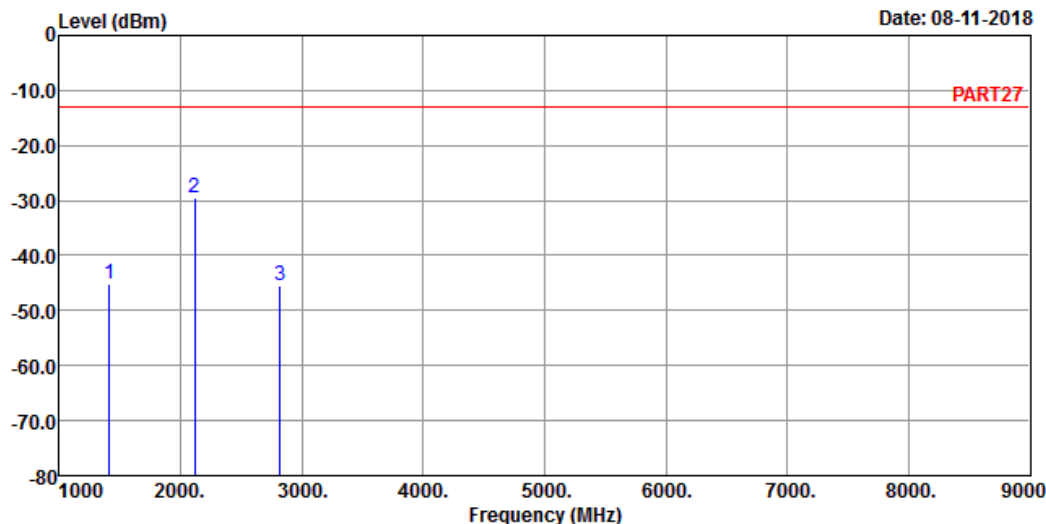

Site : 966 Chamber 5  
Condition: PART27 HORIZONTAL  
Remak : Cat-M1 Band 12 QPSK\_10M Link\_L-CH  
Tested by: Thomas Wei

	Freq	Level	Read Level	Limit Line	Over Limit	Factor	Remark
	MHz	dBm	dBm	dBm	dB	dB	
1	1408.00	-45.20	-33.24	-13.00	-32.20	-11.96	Peak
2	pp 2112.00	-29.48	-19.52	-13.00	-16.48	-9.96	Peak
3	2816.00	-45.45	-36.96	-13.00	-32.45	-8.49	Peak



Bureau Veritas Consumer Products Services Ltd., Taoyuan Branch

A D T

Data: 2

Date: 08-11-2018

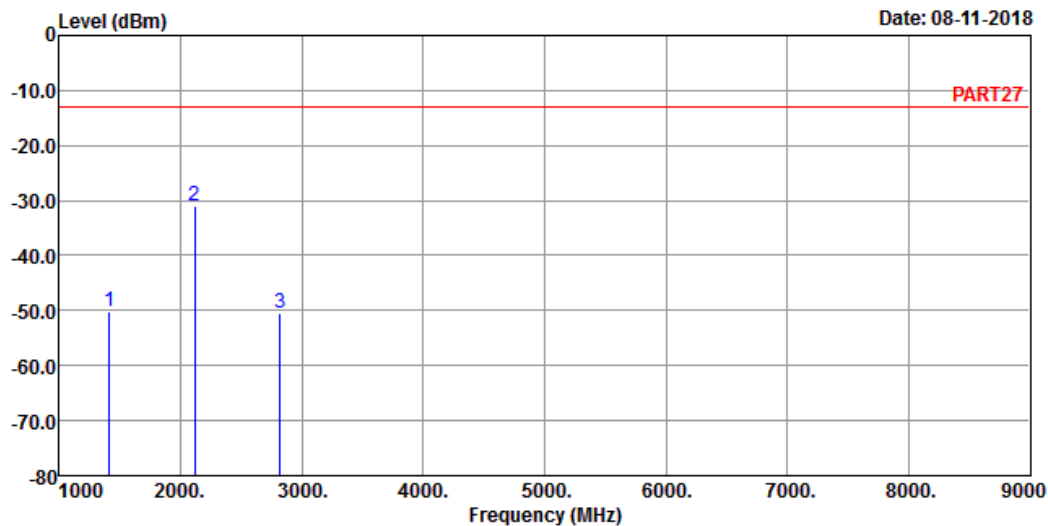

Site : 966 Chamber 5  
 Condition: PART27 VERTICAL  
 Remak : Cat-M1 Band 12 QPSK\_10M Link\_L-CH  
 Tested by: Thomas Wei

	Freq	Level	Read Level	Limit Line	Over Limit	Factor	Remark
	MHz	dBm	dBm	dBm	dB	dB	
1	1408.00	-50.15	-38.19	-13.00	-37.15	-11.96	Peak
2 pp	2112.00	-30.97	-21.01	-13.00	-17.97	-9.96	Peak
3	2816.00	-50.33	-41.84	-13.00	-37.33	-8.49	Peak

Middle Channel



Bureau Veritas Consumer Products Services Ltd., Taoyuan Branch

A D T

Data: 1

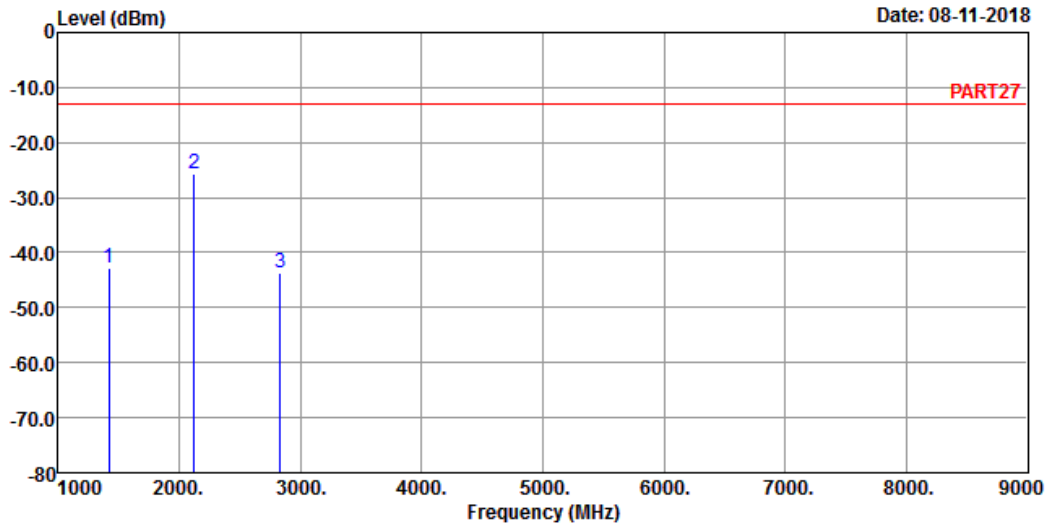

Site : 966 Chamber 5  
 Condition: PART27 HORIZONTAL  
 Remak : Cat-M1 Band 12 QPSK\_10M Link\_M-CH  
 Tested by: Thomas Wei

	Freq	Level	Read Level	Limit Line	Over Limit	Factor	Remark
	MHz	dBm	dBm	dBm	dB	dB	
1	1415.00	-42.85	-30.77	-13.00	-29.85	-12.08	Peak
2 pp	2122.50	-25.58	-15.71	-13.00	-12.58	-9.87	Peak
3	2830.00	-43.56	-35.08	-13.00	-30.56	-8.48	Peak



Bureau Veritas Consumer Products Services Ltd., Taoyuan Branch

A D T

Data: 2

Date: 08-11-2018

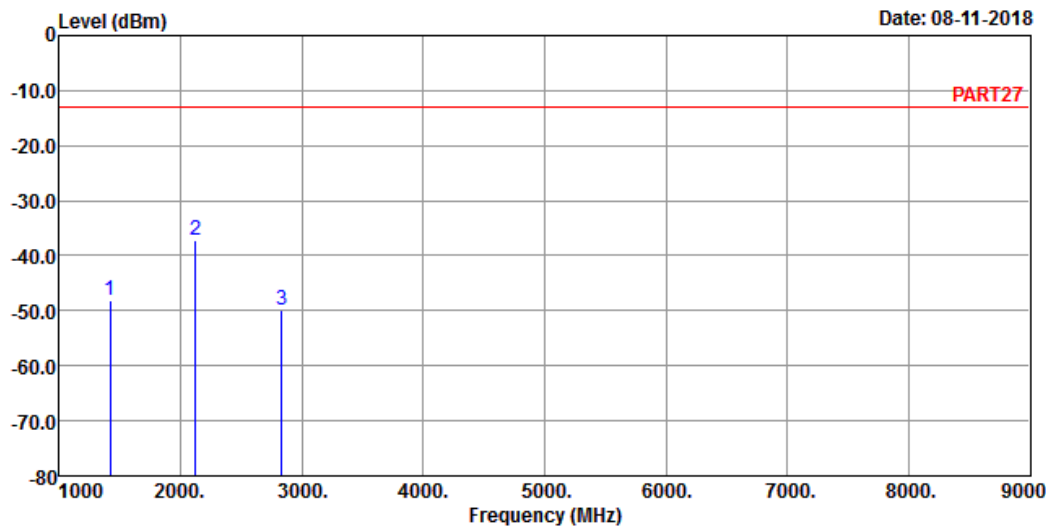

Site : 966 Chamber 5  
 Condition: PART27 VERTICAL  
 Remak : Cat-M1 Band 12 QPSK\_10M Link\_M-CH  
 Tested by: Thomas Wei

	Freq	Level	Read Level	Limit Line	Over Limit	Factor	Remark
	MHz	dBm	dBm	dBm	dB	dB	
1	1415.00	-48.15	-36.07	-13.00	-35.15	-12.08	Peak
2 pp	2122.50	-37.29	-27.42	-13.00	-24.29	-9.87	Peak
3	2830.00	-50.01	-41.53	-13.00	-37.01	-8.48	Peak

High Channel



Bureau Veritas Consumer Products Services Ltd., Taoyuan Branch

A D T

Data: 1

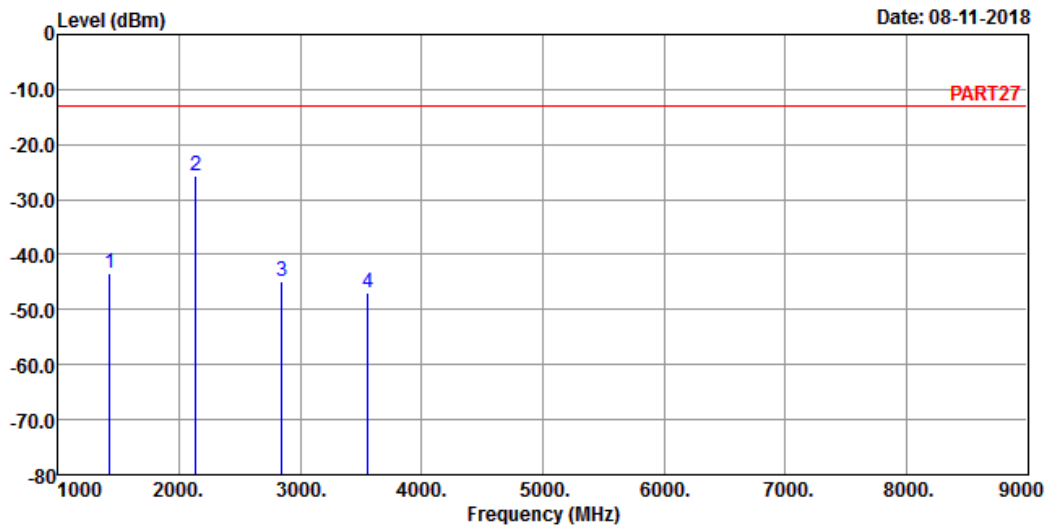

Site : 966 Chamber 5  
 Condition: PART27 HORIZONTAL  
 Remak : Cat-M1 Band 12 QPSK\_10M Link\_H-CH  
 Tested by: Thomas Wei

	Freq	Level	Read Level	Limit Line	Over Limit	Factor	Remark
	MHz	dBm	dBm	dBm	dB	dB	
1	1422.00	-43.48	-31.29	-13.00	-30.48	-12.19	Peak
2 pp	2133.00	-25.76	-16.09	-13.00	-12.76	-9.67	Peak
3	2844.00	-44.79	-36.33	-13.00	-31.79	-8.46	Peak
4	3555.00	-46.98	-39.83	-13.00	-33.98	-7.15	Peak



Bureau Veritas Consumer Products Services Ltd., Taoyuan Branch

A D T

Data: 2

Date: 08-11-2018

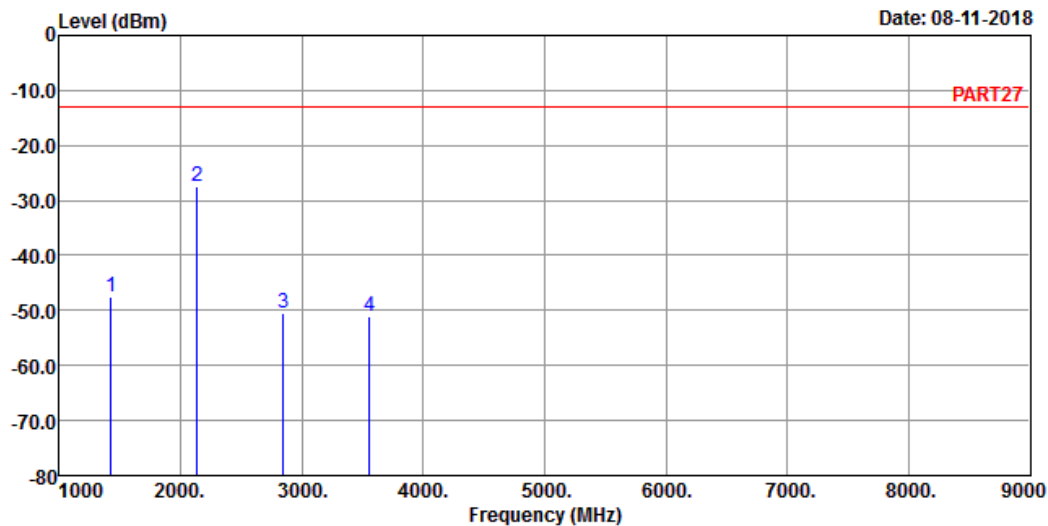

Site : 966 Chamber 5  
 Condition: PART27 VERTICAL  
 Remak : Cat-M1 Band 12 QPSK\_10M Link\_H-CH  
 Tested by: Thomas Wei

	Freq	Level	Read Level	Limit Line	Over Limit	Factor	Remark
	MHz	dBm	dBm	dBm	dB	dB	
1	1422.00	-47.44	-35.25	-13.00	-34.44	-12.19	Peak
2 pp	2133.00	-27.32	-17.65	-13.00	-14.32	-9.67	Peak
3	2844.00	-50.35	-41.89	-13.00	-37.35	-8.46	Peak
4	3555.00	-51.12	-43.97	-13.00	-38.12	-7.15	Peak

LTE Band 66:  
 Channel Bandwidth: 5 MHz / QPSK  
 Low Channel



Bureau Veritas Consumer Products Services Ltd., Taoyuan Branch

A D T

Data: 5

Date: 08-11-2018

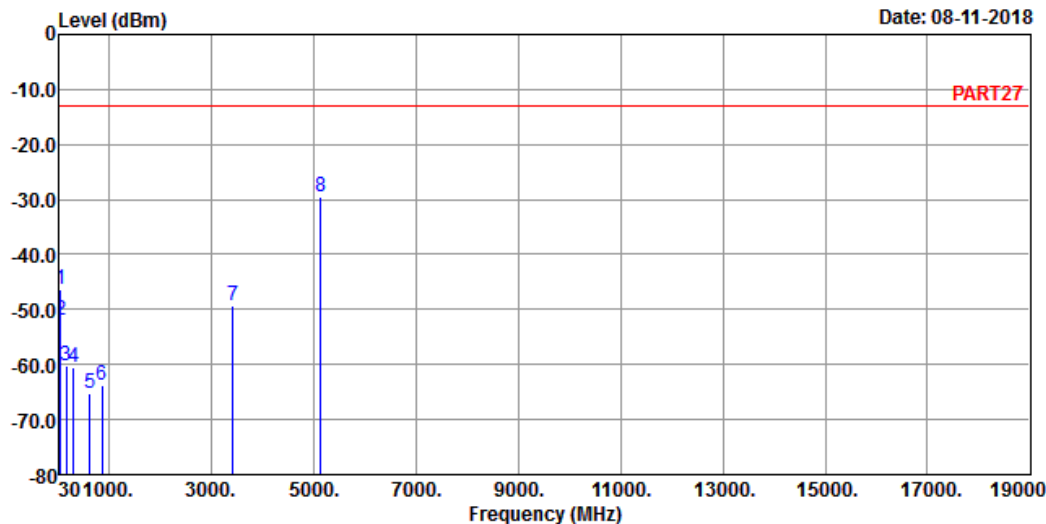

Site : 966 Chamber 5  
 Condition: PART27 HORIZONTAL  
 Remak : Cat-M1 Band 66 QPSK\_5M Link\_L-CH  
 Tested by: Thomas Wei

	Freq	Level	Read Level	Limit Line	Over Limit	Factor	Remark
	MHz	dBm	dBm	dBm	dB	dB	
1	44.55	-46.41	-44.42	-13.00	-33.41	-1.99	Peak
2	52.31	-52.06	-46.52	-13.00	-39.06	-5.54	Peak
3	162.89	-60.28	-55.23	-13.00	-47.28	-5.05	Peak
4	301.60	-60.54	-53.56	-13.00	-47.54	-6.98	Peak
5	620.73	-65.21	-64.40	-13.00	-52.21	-0.81	Peak
6	869.05	-63.89	-64.29	-13.00	-50.89	0.40	Peak
7	3425.00	-49.38	-41.04	-13.00	-36.38	-8.34	Peak
8 pp	5137.50	-29.56	-27.82	-13.00	-16.56	-1.74	Peak



Bureau Veritas Consumer Products Services Ltd., Taoyuan Branch

A D T

Data: 6

Date: 08-11-2018

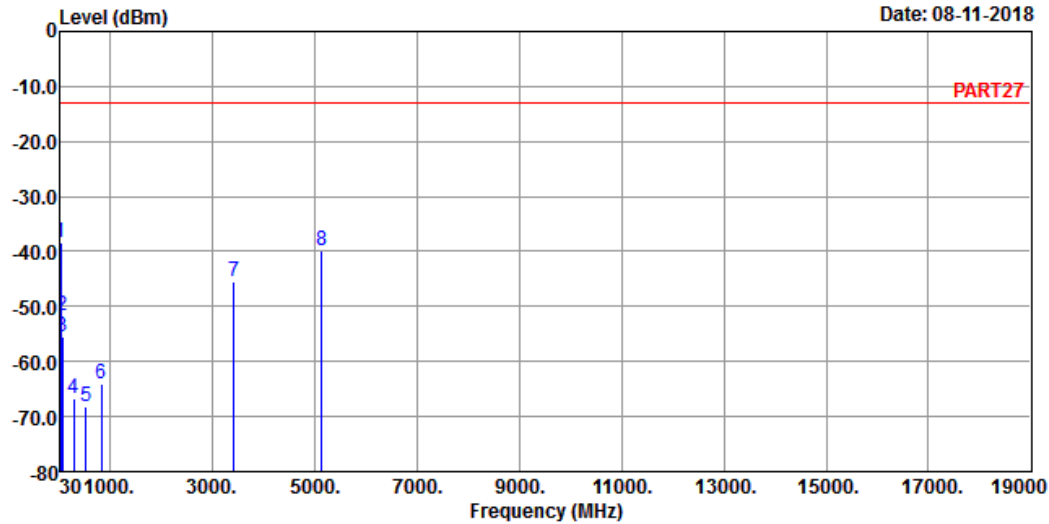

Site : 966 Chamber 5  
 Condition: PART27 VERTICAL  
 Remak : Cat-M1 Band 66 QPSK\_5M Link\_L-CH  
 Tested by: Thomas Wei

	Freq	Level	Read Level	Limit Line	Over Limit	Factor	Remark
	MHz	dBm	dBm	dBm	dB	dB	
1 pp	39.70	-38.42	-39.06	-13.00	-25.42	0.64	Peak
2	53.28	-51.78	-45.97	-13.00	-38.78	-5.81	Peak
3	68.80	-55.64	-47.32	-13.00	-42.64	-8.32	Peak
4	290.93	-66.78	-59.95	-13.00	-53.78	-6.83	Peak
5	534.40	-68.21	-64.81	-13.00	-55.21	-3.40	Peak
6	828.31	-63.99	-64.47	-13.00	-50.99	0.48	Peak
7	3425.00	-45.44	-37.10	-13.00	-32.44	-8.34	Peak
8	5137.50	-39.97	-38.23	-13.00	-26.97	-1.74	Peak



Middle Channel



Bureau Veritas Consumer Products Services Ltd., Taoyuan Branch

A D T

Data: 1

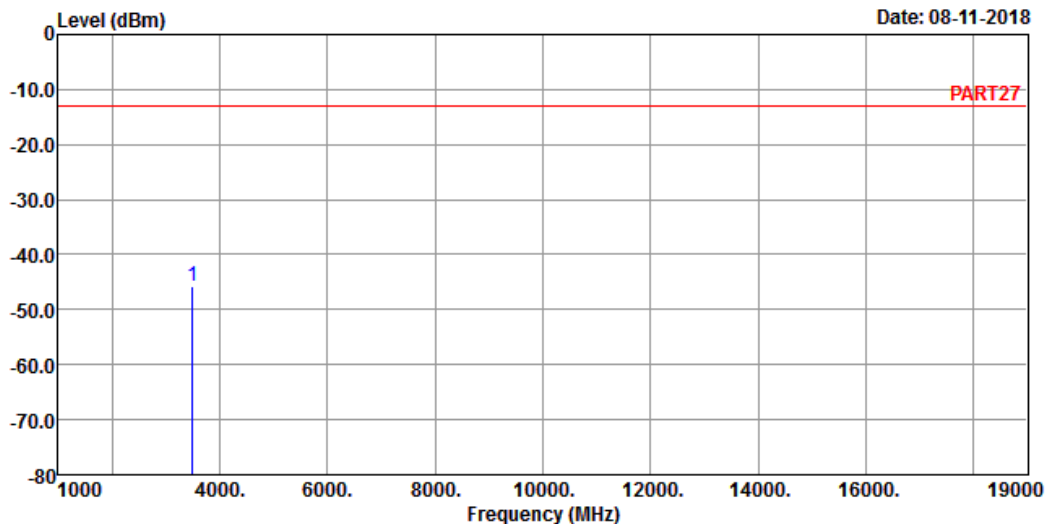

Site : 966 Chamber 5  
 Condition: PART27 HORIZONTAL  
 Remak : Cat-M1 Band 66 QPSK\_5M Link\_M-CH  
 Tested by: Thomas Wei

Freq	Level	Read Level	Limit Line	Over Limit	Factor	Remark
MHz	dBm	dBm	dBm	dB	dB	
1 pp 3490.00	-45.89	-38.24	-13.00	-32.89	-7.65	Peak



Bureau Veritas Consumer Products Services Ltd., Taoyuan Branch

A D T

Data: 2

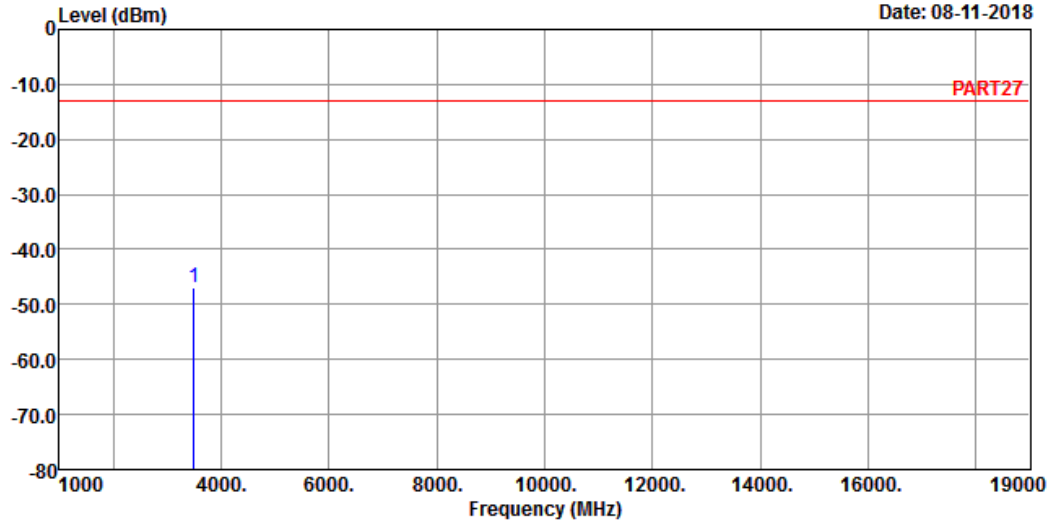

Site : 966 Chamber 5  
 Condition: PART27 VERTICAL  
 Remak : Cat-M1 Band 66 QPSK\_5M Link\_M-CH  
 Tested by: Thomas Wei

Freq	Level	Read Level	Limit Line	Over Limit	Factor	Remark
MHz	dBm	dBm	dBm	dB	dB	
1 pp 3490.00	-46.81	-39.16	-13.00	-33.81	-7.65	Peak

High Channel



Bureau Veritas Consumer Products Services Ltd., Taoyuan Branch

A D T

Data: 3

Date: 08-11-2018

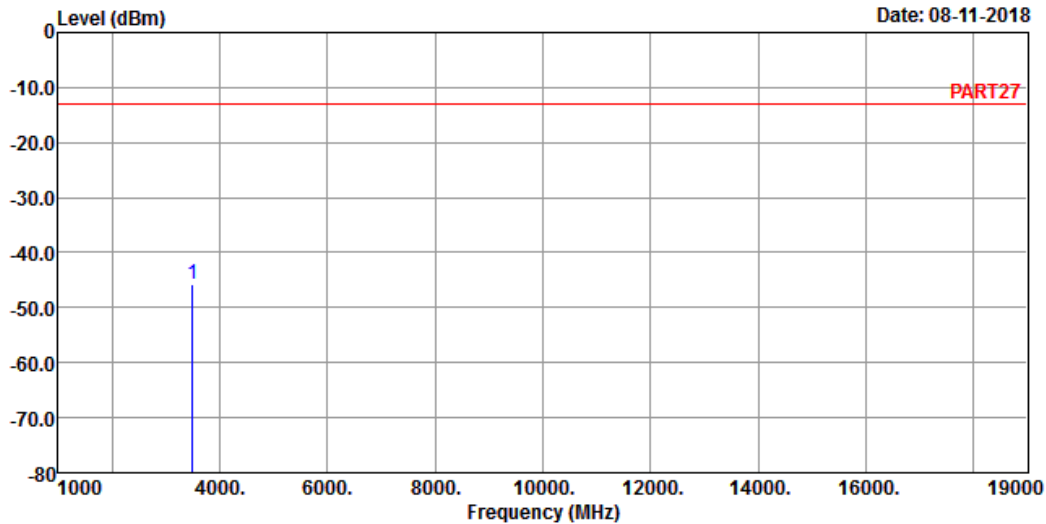

Site : 966 Chamber 5  
 Condition: PART27 HORIZONTAL  
 Remak : Cat-M1 Band 66 QPSK\_5M Link\_H-CH  
 Tested by: Thomas Wei

	Read	Limit	Over			
Freq	Level	Level	Line	Limit	Factor	Remark
MHz	dBm	dBm	dBm	dB	dB	
1 pp 3490.00	-45.89	-38.24	-13.00	-32.89	-7.65	Peak



Bureau Veritas Consumer Products Services Ltd., Taoyuan Branch

A D T

Data: 4

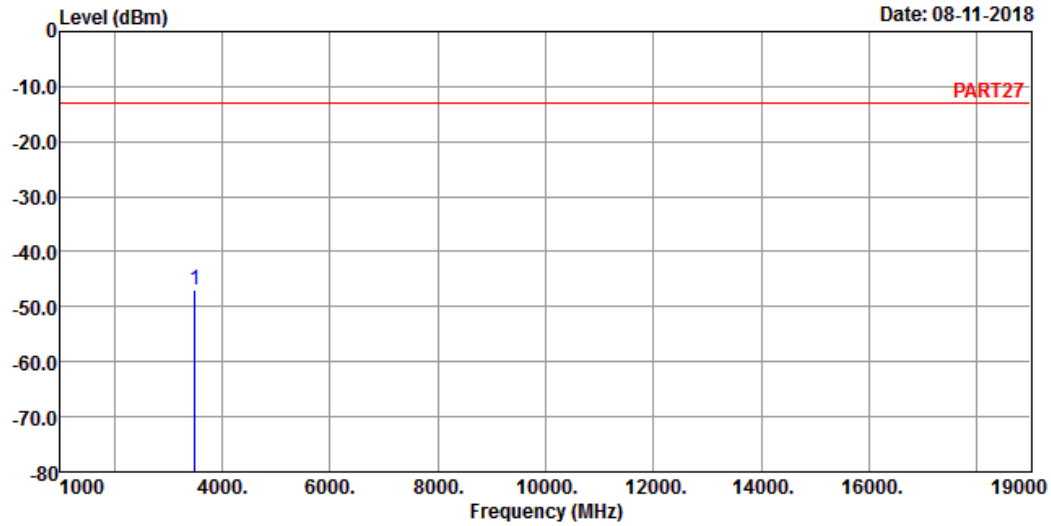

Site : 966 Chamber 5  
 Condition: PART27 VERTICAL  
 Remak : Cat-M1 Band 66 QPSK\_5M Link\_H-CH  
 Tested by: Thomas Wei

Freq	Level	Read Level	Limit Line	Over Limit	Factor	Remark
MHz	dBm	dBm	dBm	dB	dB	
1 pp 3490.00	-46.81	-39.16	-13.00	-33.81	-7.65	Peak

Channel Bandwidth: 20 MHz / QPSK  
Low Channel



Bureau Veritas Consumer Products Services Ltd., Taoyuan Branch

A D T

Data: 1

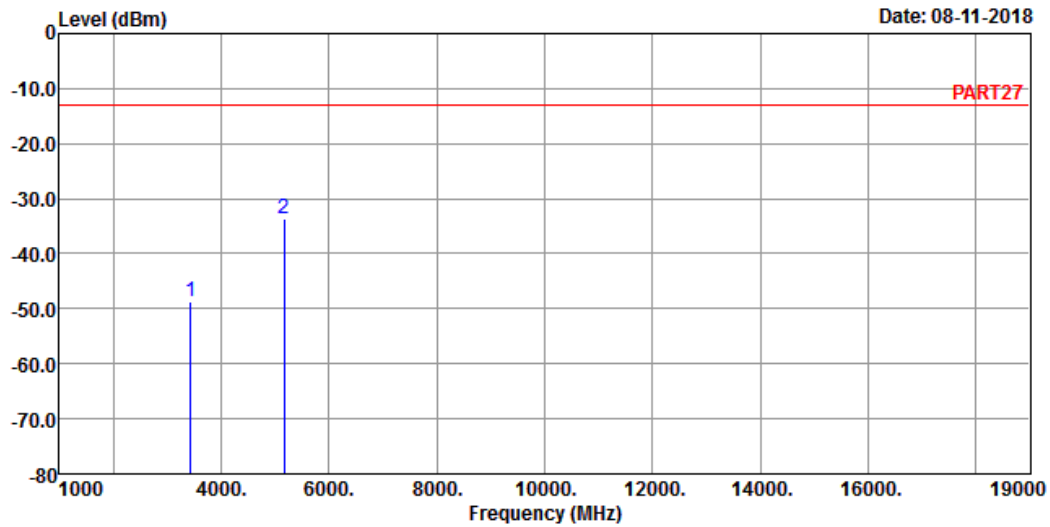

Site : 966 Chamber 5  
Condition: PART27 HORIZONTAL  
Remak : Cat-M1 Band 66 QPSK\_20M Link\_L-CH  
Tested by: Thomas Wei

	Freq	Level	Read Level	Limit Line	Over Limit	Factor	Remark
	MHz	dBm	dBm	dBm	dB	dB	
1	3440.00	-48.57	-40.35	-13.00	-35.57	-8.22	Peak
2 pp	5160.00	-33.76	-31.85	-13.00	-20.76	-1.91	Peak



Bureau Veritas Consumer Products Services Ltd., Taoyuan Branch

A D T

Data: 2

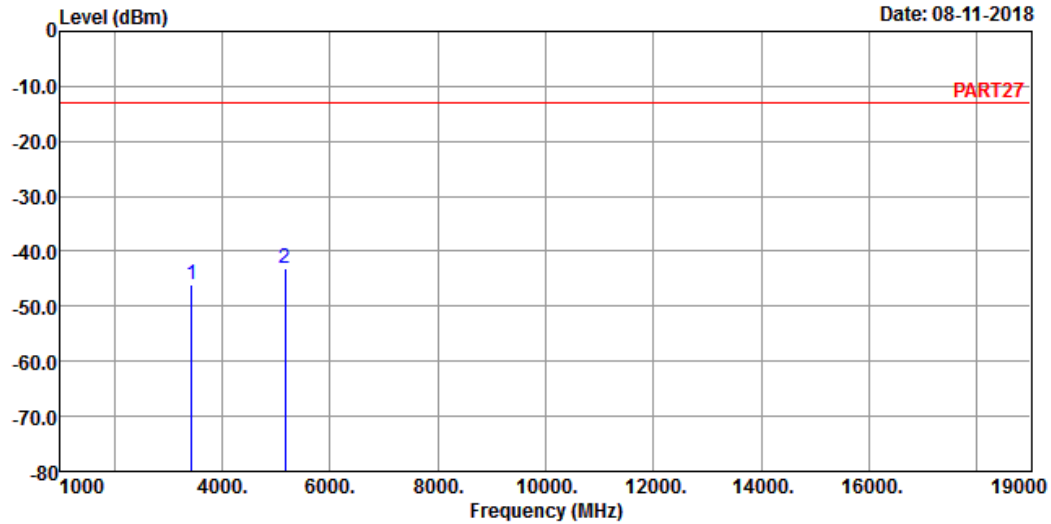

Site : 966 Chamber 5  
 Condition: PART27 VERTICAL  
 Remak : Cat-M1 Band 66 QPSK\_20M Link\_L-CH  
 Tested by: Thomas Wei

	Freq	Level	Read Level	Limit Line	Over Limit	Factor	Remark
	MHz	dBm	dBm	dBm	dB	dB	
1	3440.00	-46.02	-37.80	-13.00	-33.02	-8.22	Peak
2 pp	5160.00	-42.96	-41.05	-13.00	-29.96	-1.91	Peak

Middle Channel



Bureau Veritas Consumer Products Services Ltd., Taoyuan Branch

A D T

Data: 1

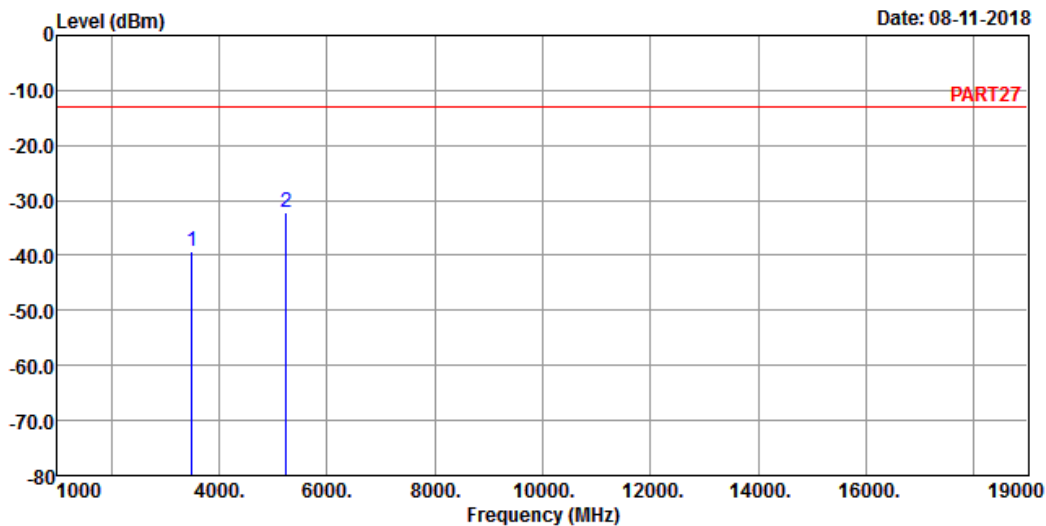

Site : 966 Chamber 5  
 Condition: PART27 HORIZONTAL  
 Remak : Cat-M1 Band 66 QPSK\_20M Link\_M-CH  
 Tested by: Thomas Wei

	Freq	Level	Read Level	Limit Line	Over Limit	Factor	Remark
	MHz	dBm	dBm	dBm	dB	dB	
1	3490.00	-39.14	-31.49	-13.00	-26.14	-7.65	Peak
2 pp	5235.00	-32.11	-29.70	-13.00	-19.11	-2.41	Peak



Bureau Veritas Consumer Products Services Ltd., Taoyuan Branch

A D T

Data: 2

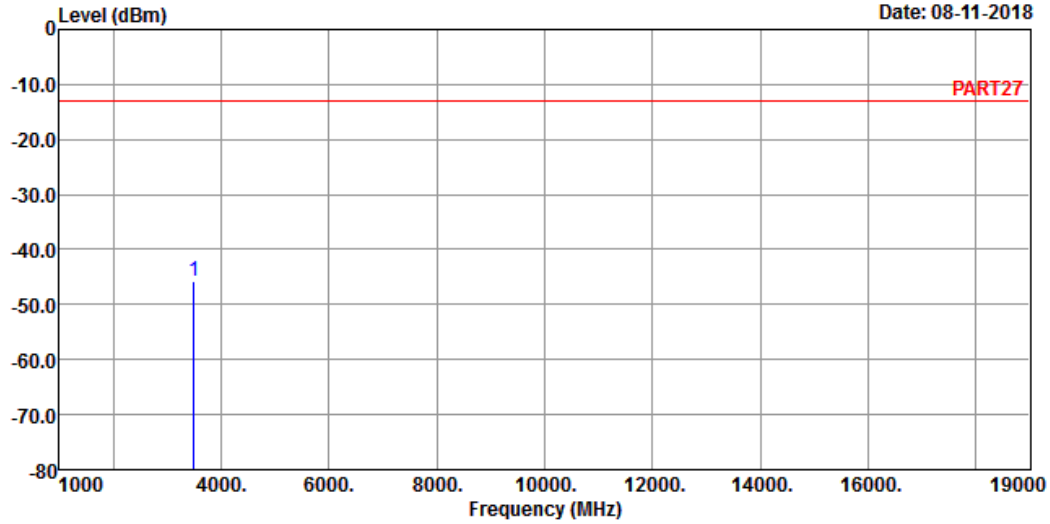

Site : 966 Chamber 5  
 Condition: PART27 VERTICAL  
 Remak : Cat-M1 Band 66 QPSK\_20M Link\_M-CH  
 Tested by: Thomas Wei

Freq	Level	Read Level	Limit Line	Over Limit	Factor	Remark
MHz	dBm	dBm	dBm	dB	dB	
1 pp 3490.00	-45.76	-38.11	-13.00	-32.76	-7.65	Peak



# High Channel



Bureau Veritas Consumer Products Services Ltd., Taoyuan Branch

A D T

Data: 3

Date: 08-14-2018

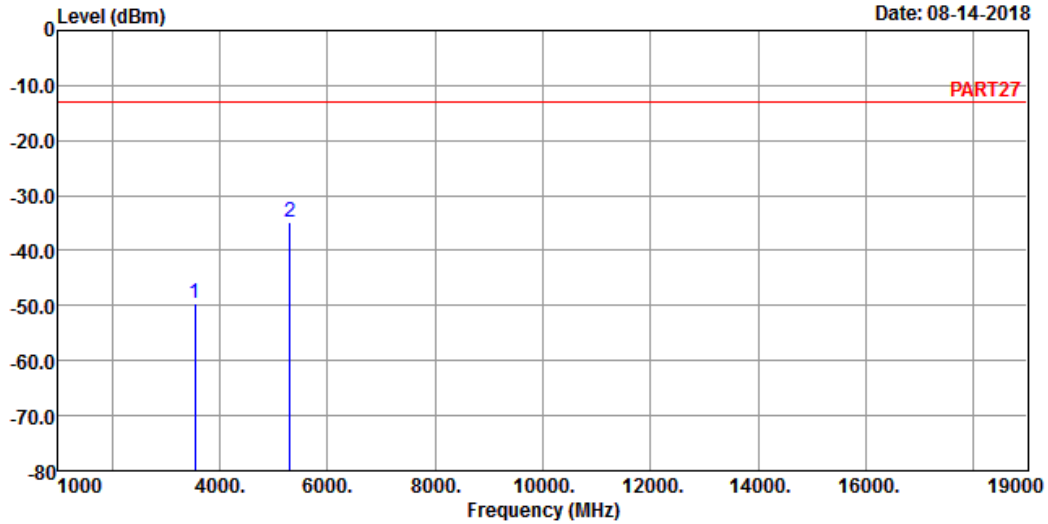

Site : 966 Chamber 5  
 Condition: PART27 HORIZONTAL  
 Remak : Cat-M1 Band 66 QPSK\_20M Link\_H-CH  
 Tested by: Thomas Wei

	Freq	Level	Read Level	Limit	Over	Factor	Remark
	MHz	dBm	dBm	dBm	dB	dB	
1	3540.00	-49.52	-42.30	-13.00	-36.52	-7.22	Peak
2 pp	5310.00	-34.96	-32.10	-13.00	-21.96	-2.86	Peak



Bureau Veritas Consumer Products Services Ltd., Taoyuan Branch

A D T

Data: 4

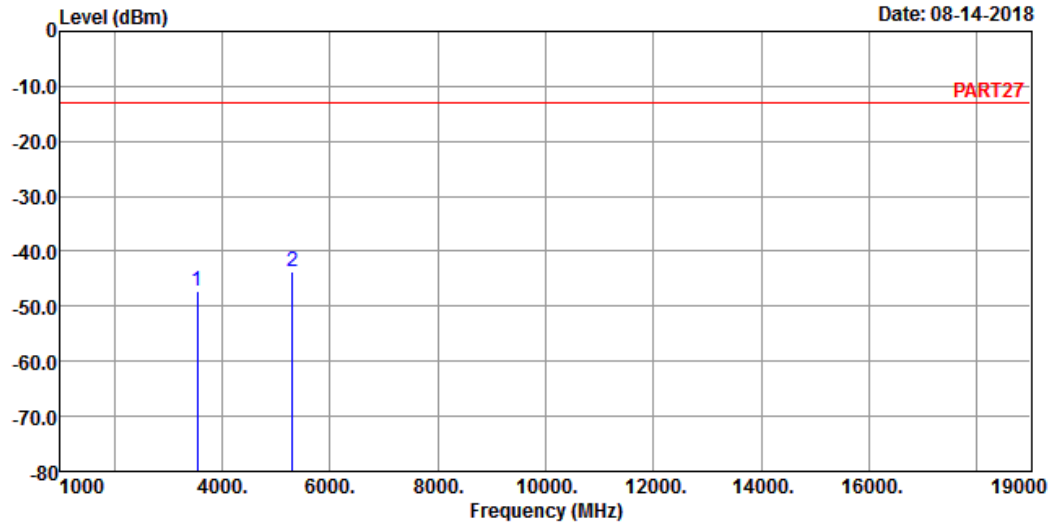

Site : 966 Chamber 5  
 Condition: PART27 VERTICAL  
 Remak : Cat-M1 Band 66 QPSK\_20M Link\_H-CH  
 Tested by: Thomas Wei

	Freq	Level	Read Level	Limit Line	Over Limit	Factor	Remark
	MHz	dBm	dBm	dBm	dB	dB	
1	3540.00	-47.25	-40.03	-13.00	-34.25	-7.22	Peak
2	5310.00	-43.65	-40.79	-13.00	-30.65	-2.86	Peak

## 5 Pictures of Test Arrangements

Please refer to the attached file (Test Setup Photo).

## Appendix – Information on the Testing Laboratories

We, Bureau Veritas Consumer Products Services (H.K.) Ltd., Taoyuan Branch, were founded in 1988 to provide our best service in EMC, Radio, Telecom and Safety consultation. Our laboratories are FCC recognized accredited test firms and accredited according to ISO/IEC 17025.

If you have any comments, please feel free to contact us at the following:

**Linko EMC/RF Lab**

Tel: 886-2-26052180

Fax: 886-2-26051924

**Hsin Chu EMC/RF/Telecom Lab**

Tel: 886-3-6668565

Fax: 886-3-6668323

**Hwa Ya EMC/RF/Safety**

Tel: 886-3-3183232

Fax: 886-3-3270892

**Email:** [service.adt@tw.bureauveritas.com](mailto:service.adt@tw.bureauveritas.com)

**Web Site:** [www.bureauveritas-adt.com](http://www.bureauveritas-adt.com)

The address and road map of all our labs can be found in our web site also.

--- END ---