



**CFR 47 FCC PART 15 SUBPART C
CERTIFICATION TEST REPORT**

For

Tablet

MODEL NUMBER: VT-TABLET-5081G

FCC ID: 2AAGE5081GB48

REPORT NUMBER: 4789823272-1

ISSUE DATE: March 12, 2021

Prepared for

**Chengdu Vantron Technology Co., Ltd.
No.5 GaoPeng Road, Hi-Tech Zone, Chengdu, SiChuan, P.R. China**

Prepared by

UL Verification Services (Guangzhou) Co., Ltd, Song Shan Lake Branch

Building 10, Innovation Technology Park, No. 1, Li Bin Road, Song Shan Lake Hi-Tech Development Zone Dongguan, 523808, People's Republic of China

Tel: +86 769 22038881

Fax: +86 769 33244054

Website: www.ul.com



Revision History

<u>Rev.</u>	<u>Issue Date</u>	<u>Revisions</u>	<u>Revised By</u>
V0	03/12/2021	Initial Issue	



Summary of Test Results			
Clause	Test Items	FCC Rules	Test Results
1	6dB Bandwidth and 99% Occupied Bandwidth	FCC Part 15.247 (a) (2)	Pass
2	Conducted Output Power	FCC Part 15.247 (b) (3)	Pass
3	Power Spectral Density	FCC Part 15.247 (e)	Pass
4	Conducted Bandedge and Spurious Emission	FCC Part 15.247 (d)	Pass
5	Radiated Bandedge and Spurious Emission	FCC Part 15.247 (d) FCC Part 15.209 FCC Part 15.205	Pass
6	Conducted Emission Test for AC Power Port	FCC Part 15.207	Pass
7	Antenna Requirement	FCC Part 15.203	Pass

Note:
1. This test report is only published to and used by the applicant, and it is not for evidence purpose in China.
2. The measurement result for the sample received is <Pass> according to < CFR 47 FCC PART 15 SUBPART C >when <Accuracy Method> decision rule is applied.



TABLE OF CONTENTS

1. ATTESTATION OF TEST RESULTS	6
2. TEST METHODOLOGY	7
3. FACILITIES AND ACCREDITATION	7
4. CALIBRATION AND UNCERTAINTY	8
4.1. MEASURING INSTRUMENT CALIBRATION	8
4.2. MEASUREMENT UNCERTAINTY	8
5. EQUIPMENT UNDER TEST	9
5.1. DESCRIPTION OF EUT	9
5.2. CHANNEL LIST	9
5.3. THE WORSE CASE POWER SETTING PARAMETER	9
5.4. MAXIMUM OUTPUT POWER	10
5.5. TEST CHANNEL CONFIGURATION	10
5.6. THE WORSE CASE CONFIGURATIONS	11
5.7. DESCRIPTION OF AVAILABLE ANTENNAS	12
5.8. DESCRIPTION OF TEST SETUP	13
6. MEASURING INSTRUMENT AND SOFTWARE USED	14
7. ANTENNA PORT TEST RESULTS	16
7.1. ON TIME AND DUTY CYCLE	16
7.2. 6 dB DTS BANDWIDTH AND 99 % OCCUPIED BANDWIDTH	17
7.3. CONDUCTED OUTPUT POWER	19
7.4. POWER SPECTRAL DENSITY	20
7.5. CONDUCTED BANDEDGE AND SPURIOUS EMISSIONS	22
8. RADIATED TEST RESULTS	24
8.1. RESTRICTED BANDEDGE	30
8.1.1. 802.11b SISO MODE	30
8.1.2. 802.11g SISO MODE	34
8.1.3. 802.11n HT20 MIMO MODE	38
8.2. SPURIOUS EMISSIONS (1 GHz ~ 3 GHz)	42
8.2.1. 802.11g SISO MODE	42
8.3. SPURIOUS EMISSIONS (3 GHz ~ 18 GHz)	48
8.3.1. 802.11b SISO MODE	48
8.3.2. 802.11g SISO MODE	54
8.3.3. 802.11n HT20 MIMO MODE	60
8.4. SPURIOUS EMISSIONS (18 GHz ~ 26 GHz)	66



8.4.1.	802.11n HT20 MIMO MODE	66
8.5.	<i>SPURIOUS EMISSIONS (30 MHz ~ 1 GHz)</i>	68
8.5.1.	802.11n HT20 MIMO MODE	68
8.6.	<i>SPURIOUS EMISSIONS BELOW 30 MHz</i>	70
8.6.1.	802.11n HT20 MIMO MODE	70
9.	AC POWER LINE CONDUCTED EMISSIONS	73
9.1.	802.11n HT20 MIMO MODE	74
10.	ANTENNA REQUIREMENTS	76
11.	Appendix	77
11.1.	<i>Appendix A: DTS Bandwidth</i>	77
11.1.1.	Test Result.....	77
11.1.2.	Test Graphs	78
11.2.	<i>Appendix B: Occupied Channel Bandwidth</i>	84
11.2.1.	Test Result.....	84
11.2.2.	Test Graphs	85
11.3.	<i>Appendix C: Maximum conducted output power</i>	91
11.3.1.	Test Result.....	91
11.4.	<i>Appendix D: Maximum power spectral density</i>	92
11.4.1.	Test Result.....	92
11.4.2.	Test Graphs	93
11.5.	<i>Appendix E: Band edge measurements</i>	99
11.5.1.	Test Result.....	99
11.5.2.	Test Graphs	100
11.6.	<i>Appendix F: Conducted Spurious Emission</i>	104
11.6.1.	Test Result.....	104
11.6.2.	Test Graphs	106
11.7.	<i>Appendix G: Duty Cycle</i>	124
11.7.1.	Test Result.....	124
11.7.2.	Test Graphs	125



1. ATTESTATION OF TEST RESULTS

Applicant Information

Company Name: Chengdu Vantron Technology Co., Ltd.
Address: No.5 GaoPeng Road, Hi-Tech Zone, Chengdu, SiChuan, P.R. China

Manufacturer Information

Company Name: Chengdu Vantron Technology Co., Ltd.
Address: No.5 GaoPeng Road, Hi-Tech Zone, Chengdu, SiChuan, P.R. China

EUT Information

EUT Name: Tablet
Model: VT-TABLET-5081G
Brand: VANTRON
Sample Received Date: January 20, 2021
Sample Status: Normal
Sample ID: /
Date of Tested: January 20, 2021~ March 05,2021

APPLICABLE STANDARDS	
STANDARD	TEST RESULTS
CFR 47 FCC PART 15 SUBPART C	PASS

Prepared By:

Jacky Jiang
Engineer Project Associate

Checked By:

Shawn Wen
Laboratory Leader

Approved By:

Stephen Guo
Laboratory Manager



2. TEST METHODOLOGY

The tests documented in this report were performed in accordance with KDB 558074 D01 15.247 Meas Guidance v05r02, KDB 414788 D01 Radiated Test Site v01r01, KDB 662911 D01 Multiple Transmitter Output v02r01, CFR 47 FCC Part 2, CFR 47 FCC Part 15, ANSI C63.10-2013.

3. FACILITIES AND ACCREDITATION

Accreditation Certificate	<p>A2LA (Certificate No.: 4102.01) UL Verification Services (Guangzhou) Co., Ltd. Song Shan Lake Branch. has been assessed and proved to be in compliance with A2LA.</p> <p>FCC (FCC Designation No.: CN1187) UL Verification Services (Guangzhou) Co., Ltd. Song Shan Lake Branch. Has been recognized to perform compliance testing on equipment subject to the Commission's Declaration of Conformity (DoC) and Certification rules</p> <p>ISED (Company No.: 21320) UL Verification Services (Guangzhou) Co., Ltd. Song Shan Lake Branch. has been registered and fully described in a report filed with ISED. The Company Number is 21320.</p> <p>VCCI (Registration No.: G-20019, R-20004, C-20012 and T-20011) UL Verification Services (Guangzhou) Co., Ltd. Song Shan Lake Branch. has been assessed and proved to be in compliance with VCCI, the Membership No. is 3793. Facility Name: Chamber D, the VCCI registration No. is G-20019 and R-20004 Shielding Room B , the VCCI registration No. is C-20012 and T-20011</p>
---------------------------	--

Note 1: All tests measurement facilities use to collect the measurement data are located at Building 10, Innovation Technology Park, Song Shan Lake Hi tech Development Zone, Dongguan, 523808, China

Note 2: The test anechoic chamber in UL Verification Services (Guangzhou) Co., Ltd. Song Shan Lake Branch had been calibrated and compared to the open field sites and the test anechoic chamber is shown to be equivalent to or worst case from the open field site.

Note 3: For below 30 MHz, lab had performed measurements at test anechoic chamber and comparing to measurements obtained on an open field site. And these measurements below 30 MHz had been correlated to measurements performed on an OFS.



4. CALIBRATION AND UNCERTAINTY

4.1. MEASURING INSTRUMENT CALIBRATION

The measuring equipment utilized to perform the tests documented in this report has been calibrated in accordance with the manufacturer's recommendations and is traceable to recognize national standards.

4.2. MEASUREMENT UNCERTAINTY

Where relevant, the following measurement uncertainty levels have been estimated for tests performed on the apparatus:

Test Item	Uncertainty
Conduction emission	3.62 dB
Radiated Emission (Included Fundamental Emission) (9 kHz ~ 30 MHz)	2.2 dB
Radiated Emission (Included Fundamental Emission) (30 MHz ~ 1 GHz)	4.00 dB
Radiated Emission (Included Fundamental Emission) (1 GHz to 26 GHz)	5.78 dB (1 GHz ~ 18 GHz)
	5.23 dB (18 GHz ~ 26 GHz)
Note: This uncertainty represents an expanded uncertainty expressed at approximately the 95% confidence level using a coverage factor of k=2.	

5. EQUIPMENT UNDER TEST

5.1. DESCRIPTION OF EUT

EUT Name	Tablet		
Model	VT-TABLET-5081G		
Radio Technology	WLAN (IEEE 802.11b/g/n HT20)		
Operation frequency	IEEE 802.11b: 2412MHz ~ 2462MHz IEEE 802.11g: 2412MHz ~ 2462MHz IEEE 802.11n HT20: 2412MHz ~ 2462MHz		
Modulation	IEEE 802.11b: DSSS (CCK, DQPSK, DBPSK) IEEE 802.11g: OFDM (64QAM, 16QAM, QPSK, BPSK) IEEE 802.11n HT20: OFDM (256QAM, 64QAM, 16QAM, QPSK, BPSK)		
Power Supply	Li-ion Battery	3.8 V, 8000 mAh, 30.4Wh	

5.2. CHANNEL LIST

Channel List for 802.11b/g/n (20 MHz)							
Channel	Frequency (MHz)	Channel	Frequency (MHz)	Channel	Frequency (MHz)	Channel	Frequency (MHz)
1	2412	4	2427	7	2442	10	2457
2	2417	5	2432	8	2447	11	2462
3	2422	6	2437	9	2452	/	/

5.3. THE WORSE CASE POWER SETTING PARAMETER

The Worst Case Power Setting Parameter under 2400 ~ 2483.5MHz Band							
Test Software		RFTtesttool					
Modulation Mode	Transmit Antenna Number	Test Channel					
		NCB: 20MHz			NCB: 40MHz		
		CH 1	CH 6	CH 11	CH 3	CH 6	CH 9
802.11b	1	default	default	default	/		
802.11g	1	default	default	default			
802.11n HT20	1	default	default	default			



5.4. MAXIMUM OUTPUT POWER

IEEE Std. 802.11	Frequency (MHz)	Channel Number	Maximum Conducted AVG Output Power (dBm)	Maximum AVG EIRP (dBm)
b	2412 ~ 2462	1-11[11]	12.58	14.78
g	2412 ~ 2462	1-11[11]	13.40	15.60
n HT20	2412 ~ 2462	1-11[11]	15.74	21.57

5.5. TEST CHANNEL CONFIGURATION

IEEE Std. 802.11	Test Channel Number	Frequency
b	CH 1(Low Channel), CH 6(MID Channel), CH 11(High Channel)	2412 MHz, 2437 MHz, 2462 MHz
g	CH 1(Low Channel), CH 6(MID Channel), CH 11(High Channel)	2412 MHz, 2437 MHz, 2462 MHz
n HT20	CH 1(Low Channel), CH 6(MID Channel), CH 11(High Channel)	2412 MHz, 2437 MHz, 2462 MHz

5.6. THE WORSE CASE CONFIGURATIONS

The EUT was tested in the following configuration(s):

Controlled in test mode using a software application on the EUT supplied by customer. The application was used to enable a continuous transmission and to select the mode, test channels, bandwidth, data rates as required.

Test channels referring to section 5.2.

Maximum power setting referring to section 5.3.

Worst case Data Rates declared by the customer:

IEEE 802.11b / SISO – DBPSK / 1 Mbps
IEEE 802.11g / SISO – BPSK / 6 Mbps
IEEE 802.11n HT20 / SISO – BPSK / MCS0

For Radiated test of 802.11b and g mode, the antenna with higher output power was selected to be test.

The EUT support Cyclic Shift Diversity(CDD), Space Time Coding(STBC), Spatial Division Multiplexing(SDM) modes. They use the same conducted power per chain in any given mode, so we only chose the worst case mode CDD for final testing.

5.7. DESCRIPTION OF AVAILABLE ANTENNAS

Antenna	Frequency (MHz)	Antenna Type	MAX Antenna Gain (dBi)
1	2412-2462	Internal Antenna	3.4
2	2412-2462	Internal Antenna	2.2

Note: Note: Directional gain= $10 \log[(10^{G1/20} + 10^{G2/20})^2 / N_{ANT}]$ dBi=5.83 dBi.

N_{ANT} : Antenna numbers

Note: The value of the antenna gain was declared by customer.

Test Mode	Transmit and Receive Mode	Description
IEEE 802.11b	<input checked="" type="checkbox"/> 2TX, 2RX	ANT 1 or ANT 2 can be used as transmitting/receiving antenna.
IEEE 802.11g	<input checked="" type="checkbox"/> 2TX, 2RX	ANT 1 or 2 can be used as transmitting/receiving antenna.
IEEE 802.11n HT20	<input checked="" type="checkbox"/> 2TX, 2RX	ANT1&2 can be used as transmitting/receiving antenna.
Note: 1.BT, BLE, WLAN 2.4G and WLAN 5G can't transmit simultaneously. (declared by client)		

Note: The value of the antenna gain was declared by customer.

5.8. DESCRIPTION OF TEST SETUP

SUPPORT EQUIPMENT

Item	Equipment	Brand Name	Model Name	P/N
/	/	/	/	/

I/O CABLES

Cable No	Port	Connector Type	Cable Type	Cable Length(m)	Remarks
1	USB	Type C	/	1.0	/

ACCESSORIES

Item	Accessory	Brand Name	Model Name	Description
1	Power supply	/	NA010050020	OUTPUT 5V, 2A
2	Earphone	/	/	/
3	TF Card	/	/	/

TEST SETUP

The EUT can work in engineering mode with a software installed.

SETUP DIAGRAM FOR TESTS

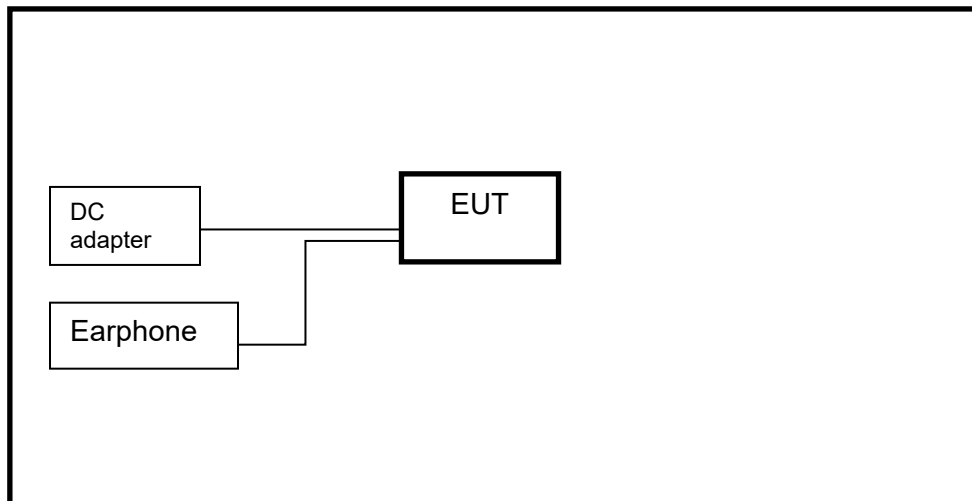

**6. MEASURING INSTRUMENT AND SOFTWARE USED**

Conducted Emissions					
Equipment	Manufacturer	Model No.	Serial No.	Last Cal.	Due Date
EMI Test Receiver	R&S	ESR3	101961	Nov. 12, 2020	Nov. 11, 2021
Two-Line V-Network	R&S	ENV216	101983	Nov. 12, 2020	Nov. 11, 2021
Artificial Mains Networks	Schwarzbeck	NSLK 8126	8126465	Nov. 12, 2020	Nov. 11, 2021
Software					
Description			Manufacturer	Name	Version
Test Software for Conducted Emissions			Farad	EZ-EMC	Ver. UL-3A1
Radiated Emissions					
Equipment	Manufacturer	Model No.	Serial No.	Last Cal.	Due Date
MXE EMI Receiver	KESIGHT	N9038A	MY56400036	Nov. 12, 2020	Nov. 11, 2021
Hybrid Log Periodic Antenna	TDK	HLP-3003C	130959	Sept. 17, 2018	Sept. 17, 2021
Hybrid Log Periodic Antenna	TDK	HLP-3003C	130960	Aug. 11, 2018	Aug. 11, 2021
Preamplifier	HP	8447D	2944A09099	Nov. 12, 2020	Nov. 11, 2021
EMI Measurement Receiver	R&S	ESR26	101377	Nov. 12, 2020	Nov. 11, 2021
Horn Antenna	TDK	HRN-0118	130939	Sept. 17, 2018	Sept. 17, 2021
Preamplifier	TDK	PA-02-0118	TRS-305-00067	Nov. 20, 2020	Nov. 19, 2021
Horn Antenna	Schwarzbeck	BBHA9170	#691	Aug. 11, 2018	Aug. 11, 2021
Preamplifier	TDK	PA-02-2	TRS-307-00003	Nov. 12, 2020	Nov. 11, 2021
Preamplifier	TDK	PA-02-3	TRS-308-00002	Nov. 12, 2020	Nov. 11, 2021
Loop antenna	Schwarzbeck	1519B	00008	Jan.17, 2019	Jan.17,2022
Preamplifier	TDK	PA-02-001-3000	TRS-302-00050	Nov. 12, 2020	Nov. 11, 2021
High Pass Filter	Wi	WHKX10-2700-3000-18000-40SS	23	Nov. 12, 2020	Nov. 11, 2021
Band Reject Filter	Wainwright	WRCJV8-2350-2400-2483.5-2533.5-40SS	4	Nov. 12, 2020	Nov. 11, 2021



Software					
Description	Manufacturer	Name	Version		
Test Software for Radiated Emissions	Farad	EZ-EMC	Ver. UL-3A1		
Tonsend RF Test System					
Equipment	Manufacturer	Model No.	Serial No.	Last Cal.	Due. Date
Wideband Radio Communication Tester	R&S	CMW500	155523	Nov.20,2020	Nov.19,2021
PXA Signal Analyzer	Keysight	N9030A	MY55410512	Nov.20,2020	Nov.19,2021
MXG Vector Signal Generator	Keysight	N5182B	MY56200284	Nov.20,2020	Nov.19,2021
MXG Vector Signal Generator	Keysight	N5172B	MY56200301	Nov.20,2020	Nov.19,2021
DC power supply	Keysight	E3642A	MY55159130	Nov.24,2020	Nov.23,2021
Temperature & Humidity Chamber	SANMOOD	SG-80-CC-2	2088	Nov.20,2020	Nov.19,2021
Software					
Description	Manufacturer	Name	Version		
Tonsend SRD Test System	Tonsend	JS1120-3 RF Test System	2.6.77.0518		
Other Instruments					
Equipment	Manufacturer	Model No.	Serial No.	Last Cal.	Next Cal.
Dual Channel Power Meter	Keysight	N1912A	MY55416024	Nov. 20, 2020	Nov. 19, 2021
Power Sensor	Keysight	USB Wideband Power Sensor	MY5100022	Nov. 20, 2020	Nov. 19, 2021

7. ANTENNA PORT TEST RESULTS

7.1. ON TIME AND DUTY CYCLE

LIMITS

None; for reporting purposes only

PROCEDURE

Refer to ANSI C63.10-2013 clause 11.6 Zero – Span Spectrum Analyzer method.

TEST SETUP

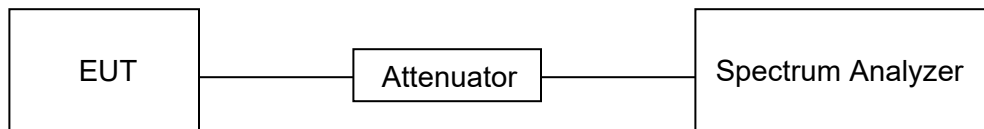

TEST ENVIRONMENT

Temperature	26.3 °C	Relative Humidity	67.5 %
Atmosphere Pressure	101 kPa	Test Voltage	DC 5 V

RESULTS

Please refer to appendix G.

**7.2. 6 dB DTS BANDWIDTH AND 99 % OCCUPIED BANDWIDTH****LIMITS**

CFR 47 FCC Part15 (15.247) Subpart C			
Section	Test Item	Limit	Frequency Range (MHz)
CFR 47 FCC 15.247(a)(2)	6 dB Bandwidth	≥ 500 kHz	2400-2483.5
ISED RSS-Gen Clause 6.7	99 % Occupied Bandwidth	For reporting purposes only.	2400-2483.5

TEST PROCEDURE

Refer to ANSI C63.10-2013 clause 11.8 for DTS bandwidth and clause 6.9 for Occupied Bandwidth.

Connect the EUT to the spectrum analyzer and use the following settings:

Center Frequency	The center frequency of the channel under test
Frequency Span	Between 1.5 times and 5.0 times the OBW
Detector	Peak
RBW	For 6 dB Bandwidth: 100 kHz For 99 % Occupied Bandwidth: 1 % to 5 % of the occupied bandwidth
VBW	For 6 dB Bandwidth: $\geq 3 \times$ RBW For 99 % Occupied Bandwidth: $\geq 3 \times$ RBW
Trace	Max hold
Sweep	Auto couple

- a) Use the 99 % power bandwidth function of the instrument, allow the trace to stabilize and report the measured bandwidth.
- b) Allow the trace to stabilize and measure the maximum width of the emission that is constrained by the frequencies associated with the two outermost amplitude points (upper and lower frequencies) that are attenuated by 6 dB relative to the maximum level measured in the fundamental emission.



TEST SETUP

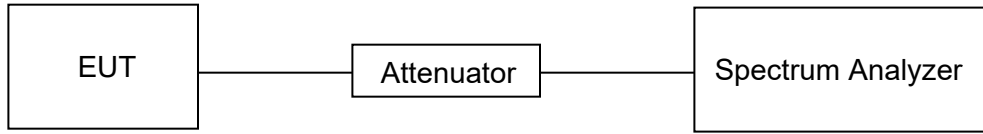

TEST ENVIRONMENT

Temperature	26.3 °C	Relative Humidity	67.5 %
Atmosphere Pressure	101 kPa	Test Voltage	DC 5 V

RESULTS

Please refer to appendix A & B.

7.3. CONDUCTED OUTPUT POWER

LIMITS

CFR 47 FCC Part15 (15.247) Subpart C			
Section	Test Item	Limit	Frequency Range (MHz)
CFR 47 FCC 15.247(b)(3)	Conducted Output Power	1 watt or 30 dBm	2400-2483.5

TEST PROCEDURE

Refer to ANSI C63.10-2013 clause 11.9.

Connect the EUT to a low loss RF cable from the antenna port to the power sensor (video bandwidth is greater than the occupied bandwidth). Measure peak emission level, the indicated level is the average output power, after any corrections for external attenuators and cables.

TEST SETUP

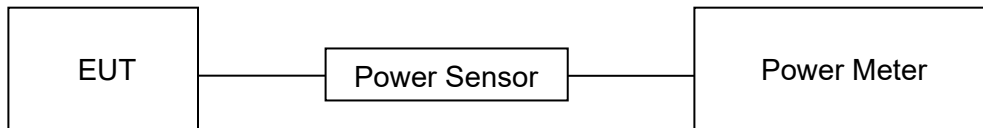

TEST ENVIRONMENT

Temperature	26.3 °C	Relative Humidity	67.5 %
Atmosphere Pressure	101 kPa	Test Voltage	DC 5 V

RESULTS

Please refer to appendix C.

7.4. POWER SPECTRAL DENSITY

LIMITS

CFR 47 FCC Part15 (15.247) Subpart C			
Section	Test Item	Limit	Frequency Range (MHz)
CFR 47 FCC §15.247 (e)	Power Spectral Density	8 dBm/3 kHz	2400-2483.5

TEST PROCEDURE

Refer to ANSI C63.10-2013 clause 11.10.

Connect the EUT to the spectrum analyzer and use the following settings:

Center Frequency	The center frequency of the channel under test
Detector	Peak
RBW	$3 \text{ kHz} \leq \text{RBW} \leq 100 \text{ kHz}$
VBW	$\geq 3 \times \text{RBW}$
Span	1.5 x DTS bandwidth
Trace	Max hold
Sweep time	Auto couple

Allow trace to fully stabilize and use the peak marker function to determine the maximum amplitude level within the RBW.

If measured value exceeds limit, reduce RBW (no less than 3 kHz) and repeat.

TEST SETUP

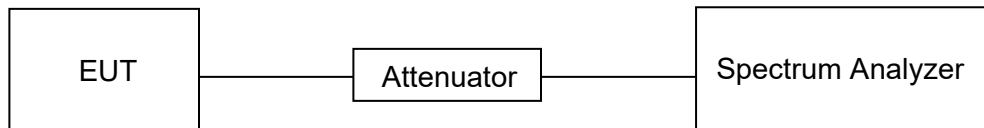

TEST ENVIRONMENT

Temperature	26.3 °C	Relative Humidity	67.5 %
Atmosphere Pressure	101 kPa	Test Voltage	DC 5 V



RESULTS

Please refer to appendix D.



7.5. CONDUCTED BANDEGE AND SPURIOUS EMISSIONS

LIMITS

CFR 47 FCC Part15 (15.247) Subpart C		
Section	Test Item	Limit
CFR 47 FCC §15.247 (d)	Conducted Bandedge and Spurious Emissions	at least 30 dB below that in the 100 kHz bandwidth within the band that contains the highest level of the desired power

TEST PROCEDURE

Refer to ANSI C63.10-2013 clause 11.11 and 11.13.

Connect the EUT to the spectrum analyzer and use the following settings for reference level measurement:

Center Frequency	The center frequency of the channel under test
Detector	Peak
RBW	100 kHz
VBW	$\geq 3 \times \text{RBW}$
Span	1.5 x DTS bandwidth
Trace	Max hold
Sweep time	Auto couple.

Allow trace to fully stabilize and use the peak marker function to determine the maximum PSD level.

Change the settings for emission level measurement:

Span	Set the center frequency and span to encompass frequency range to be measured
Detector	Peak
RBW	100 kHz
VBW	$\geq 3 \times \text{RBW}$
measurement points	$\geq \text{span}/\text{RBW}$
Trace	Max hold
Sweep time	Auto couple.

Allow trace to fully stabilize and use the peak marker function to determine the maximum PSD level. Ensure that the amplitude of all unwanted emissions outside of the authorized frequency band (excluding restricted frequency bands) is attenuated by at least the minimum requirements specified in 11.11.

TEST SETUP

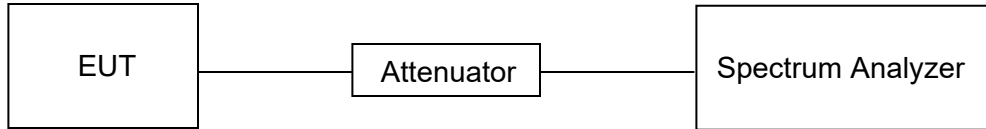

TEST ENVIRONMENT

Temperature	26.3 °C	Relative Humidity	67.5 %
Atmosphere Pressure	101 kPa	Test Voltage	DC 5 V

RESULTS

Please refer to appendix E & F.



8. RADIATED TEST RESULTS

LIMITS

Please refer to CFR 47 FCC §15.205 and §15.209.

Radiation Disturbance Test Limit for FCC (Class B) (9 kHz ~ 1 GHz)

Emissions radiated outside of the specified frequency bands above 30 MHz			
Frequency Range (MHz)	Field Strength Limit (uV/m) at 3 m	Field Strength Limit (dBuV/m) at 3 m	
		Quasi-Peak	
30 - 88	100	40	
88 - 216	150	43.5	
216 - 960	200	46	
Above 960	500	54	
Above 1000	500	Peak	Average
		74	54

FCC Emissions radiated outside of the specified frequency bands below 30 MHz		
Frequency (MHz)	Field strength (microvolts/meter)	Measurement distance (meters)
0.009-0.490	2400/F(kHz)	300
0.490-1.705	24000/F(kHz)	30
1.705-30.0	30	30

FCC Restricted bands of operation refer to FCC §15.205 (a):

MHz	MHz	MHz	GHz
0.090-0.110	16.42-16.423	399.9-410	4.5-5.15
¹ 0.495-0.505	16.69475-16.69525	608-614	5.35-5.46
2.1735-2.1905	16.80425-16.80475	960-1240	7.25-7.75
4.125-4.128	25.5-25.67	1300-1427	8.025-8.5
4.17725-4.17775	37.5-38.25	1435-1626.5	9.0-9.2
4.20725-4.20775	73-74.6	1645.5-1646.5	9.3-9.5
6.215-6.218	74.8-75.2	1660-1710	10.6-12.7
6.26775-6.26825	108-121.94	1718.8-1722.2	13.25-13.4
6.31175-6.31225	123-138	2200-2300	14.47-14.5
8.291-8.294	149.9-150.05	2310-2390	15.35-16.2
8.362-8.366	156.52475-156.52525	2483.5-2500	17.7-21.4
8.37625-8.38675	156.7-156.9	2690-2900	22.01-23.12
8.41425-8.41475	162.0125-167.17	3260-3267	23.6-24.0
12.29-12.293	167.72-173.2	3332-3339	31.2-31.8
12.51975-12.52025	240-285	3345.8-3358	36.43-36.5
12.57675-12.57725	322-335.4	3600-4400	(²)
13.36-13.41			

Note: ¹Until February 1, 1999, this restricted band shall be 0.490-0.510 MHz.
²Above 38.6c

TEST SETUP AND PROCEDURE

Below 30 MHz

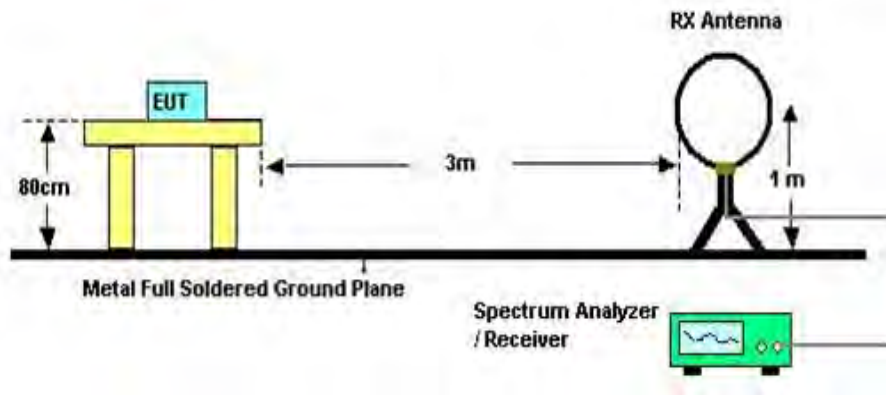

The setting of the spectrum analyzer

RBW	200 Hz (From 9 kHz to 0.15 MHz) / 9 kHz (From 0.15 MHz to 30 MHz)
VBW	200 Hz (From 9 kHz to 0.15 MHz) / 9 kHz (From 0.15 MHz to 30 MHz)
Sweep	Auto
Trace	Max hold

1. The testing follows the guidelines in ANSI C63.10-2013 clause 6.4.
2. The EUT was arranged to its worst case and then turntable (from 0 degree to 360 degrees) to find the maximum reading. A pre-amp and a high pass filter are used for the test in order to get better signal level. Both Horizontal, Face-on and Face-off polarizations of the antenna are set to make the measurement.
3. The EUT was placed on a turntable with 80cm above ground.
4. The EUT was set 3 meters from the interference receiving antenna, which was mounted on the top of a 1 m height antenna tower.



5. The radiated emission limits are based on measurements employing a CISPR quasi-peak detector except for the frequency bands 9-90 kHz, 110-490 kHz and above 1000 MHz. Radiated emission limits in these three bands are based on measurements employing an average detector.
6. For measurement below 1 GHz, the initial step in collecting conducted emission data is a spectrum analyzer peak detector mode pre-scanning the measurement frequency range. Significant peaks are then marked and then Quasi Peak and average detector mode re-measured. If the emission level of the EUT measured by the peak detector is 3 dB lower than the applicable limit, the peak emission level will be reported. Otherwise, the emission measurement will be repeated using the quasi-peak and average detector and reported.
7. Although these tests were performed other than open field site, adequate comparison measurements were confirmed against 30 m open field site. Therefore sufficient tests were made to demonstrate that the alternative site produces results that correlate with the ones of tests made in an open field site based on KDB 414788.

Below 1 GHz and above 30 MHz

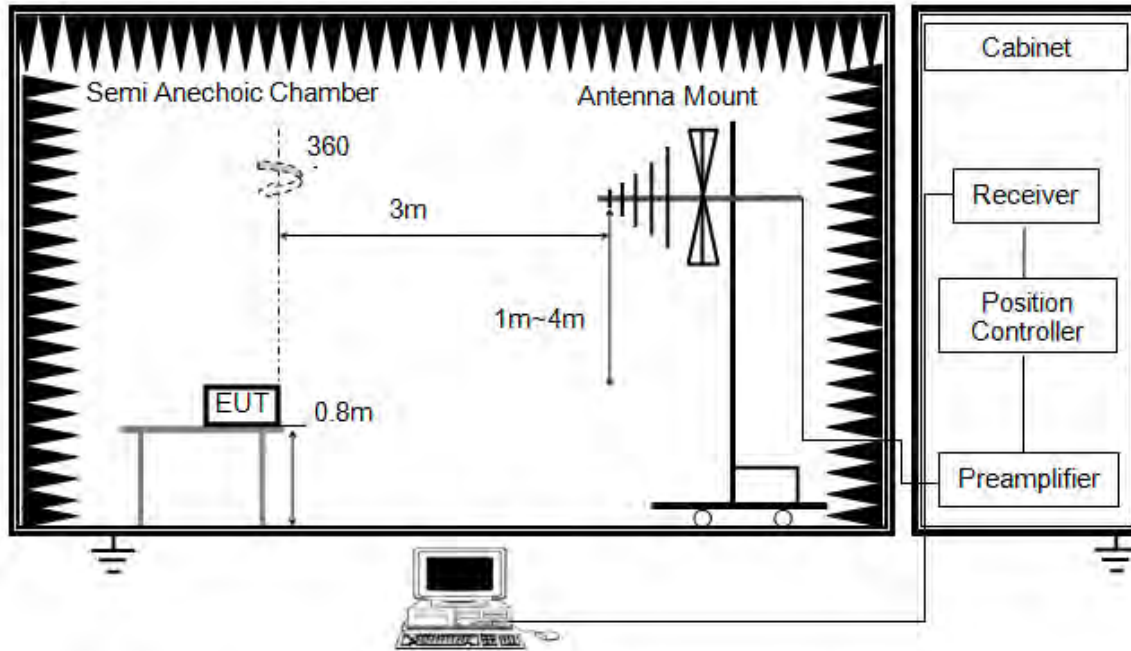

The setting of the spectrum analyzer

RBW	120 kHz
VBW	300 kHz
Sweep	Auto
Detector	Peak/QP
Trace	Max hold

1. The testing follows the guidelines in ANSI C63.10-2013 clause 6.5.
2. The EUT was arranged to its worst case and then tune the antenna tower (from 1 m to 4 m) and turntable (from 0 degree to 360 degrees) to find the maximum reading. A pre-amp and a high pass filter are used for the test in order to get better signal level. Both horizontal and vertical polarizations of the antenna are set to make the measurement.
3. The EUT was placed on a turntable with 80 cm above ground.
4. The EUT was set 3 meters from the interference receiving antenna, which was mounted on the top of a variable height antenna tower.
5. For measurement below 1 GHz, the initial step in collecting conducted emission data is a spectrum analyzer peak detector mode pre-scanning the measurement frequency range. Significant peaks are then marked and then Quasi Peak detector mode re-measured. If the emission level of the EUT measured by the peak detector is 3 dB lower than the applicable limit, the peak emission level will be reported. Otherwise, the emission measurement will be repeated using the quasi-peak detector and reported.

Above 1 GHz

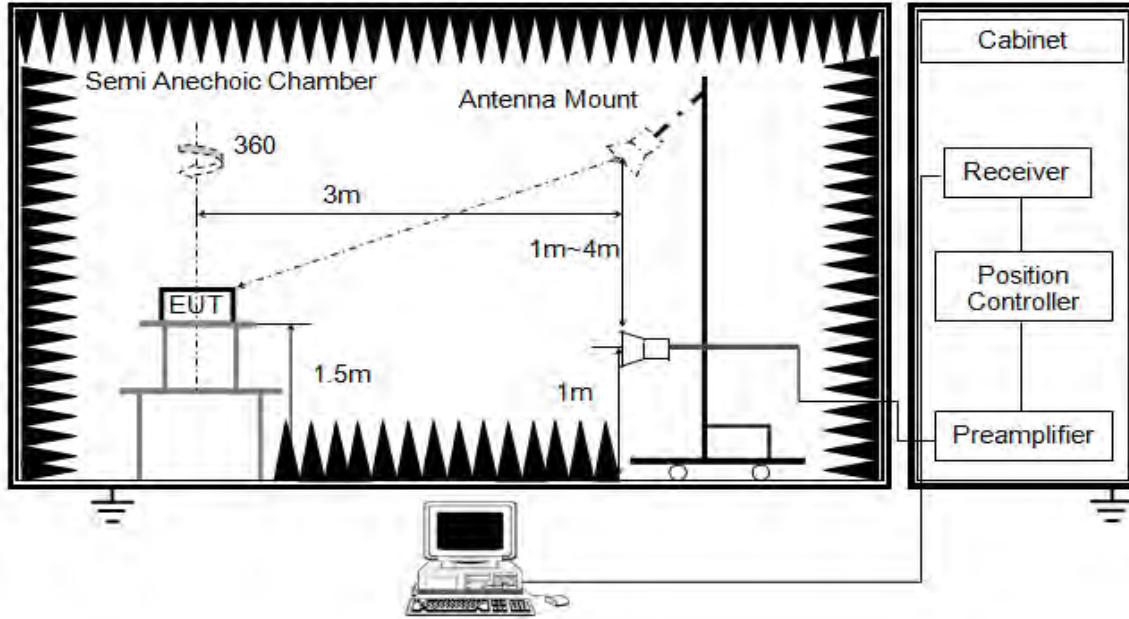

The setting of the spectrum analyzer

RBW	1 MHz
VBW	PEAK: 3 MHz AVG: see note 6
Sweep	Auto
Detector	Peak
Trace	Max hold

1. The testing follows the guidelines in ANSI C63.10-2013 clause 6.6.
2. The EUT was arranged to its worst case and then tune the antenna tower (1- s4 m) and turntable (from 0 degree to 360 degrees) to find the maximum reading. A pre-amp and a high pass filter are used for the test in order to get better signal level. Both horizontal and vertical polarizations of the antenna are set to make the measurement.
3. The EUT was placed on a turntable with 1.5 m above ground.
4. The EUT was set 3 meters from the interference receiving antenna, which was mounted on the top of a variable height antenna tower.
5. For measurement above 1 GHz, the emission measurement will be measured by the peak detector. This peak level, once corrected, must comply with the limit specified in Section 15.209.
6. For measurements above 1 GHz the resolution bandwidth is set to 1 MHz, then the video bandwidth is set to 3 MHz for peak measurements and 1 MHz resolution bandwidth with 1/T video bandwidth with peak detector for average measurements. For the Duty Cycle please refer to clause 7.1.ON TIME AND DUTY CYCLE.

X axis, Y axis, Z axis positions:

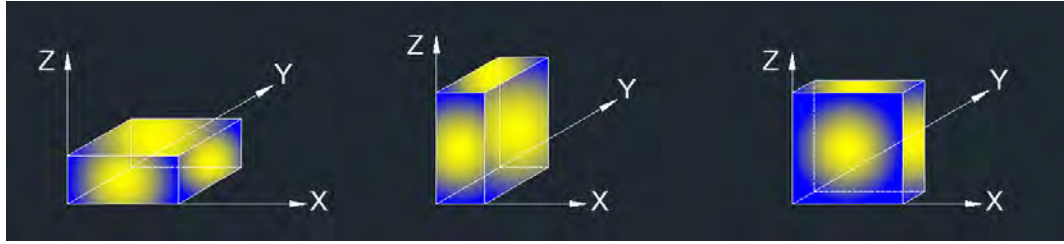

Note 1: For all radiated test, EUT in each of three orthogonal axis emissions had been tested, but only the worst case (X axis) data recorded in the report.

Note 2: Simultaneous transmission was not evaluated with the 2.4 GHz WiFi, 5 GHz WiFi and BT transmitter due they couldn't transmit in simultaneous.

Note 3: The EUT was fully exercised with external accessories during the test. In the case of multiple accessory external ports, an external accessory shall be connected to one of each type of port.

TEST ENVIRONMENT

Temperature	22.6 °C	Relative Humidity	64.4 %
Atmosphere Pressure	101 kPa	Test Voltage	DC 5 V

RESULTS

8.1. RESTRICTED BANDEDGE

8.1.1. 802.11b SISO MODE

RESTRICTED BANDEDGE (LOW CHANNEL, VERTICAL)

PEAK

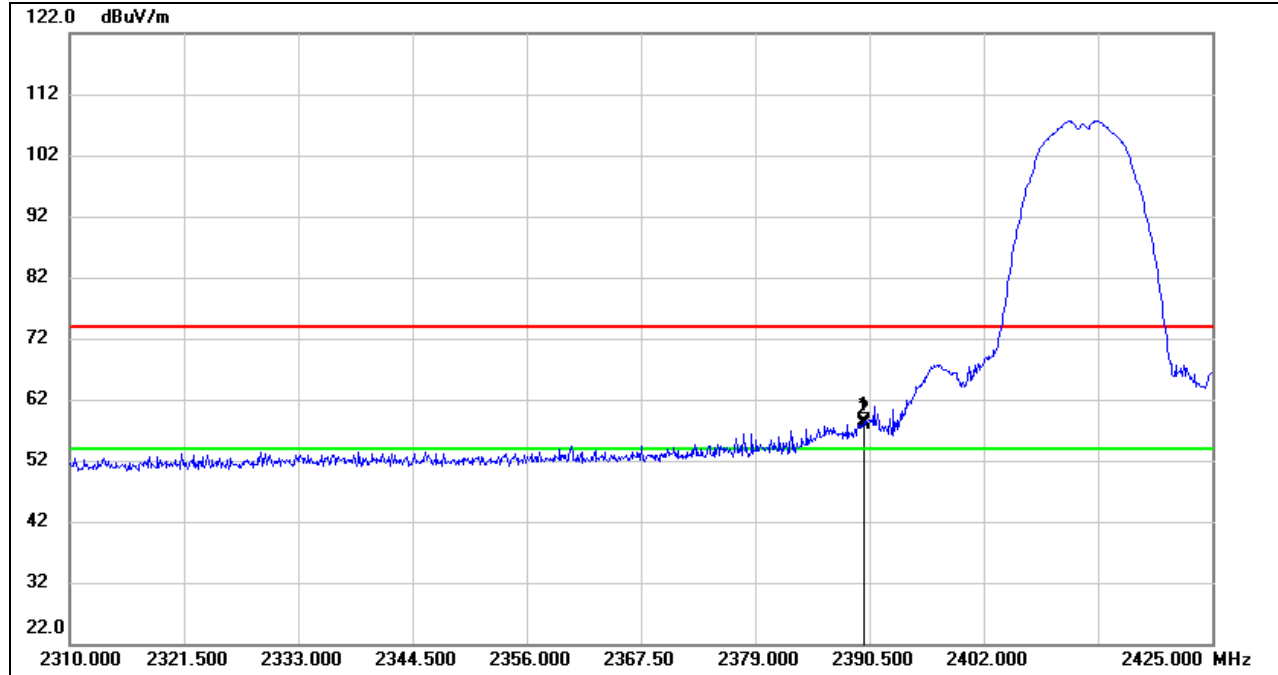

No.	Frequency (MHz)	Reading (dBuV)	Correct (dB/m)	Result (dBuV/m)	Limit (dBuV/m)	Margin (dB)	Remark
1	2389.925	24.97	33.35	58.32	74.00	-15.68	peak
2	2390.000	24.52	33.35	57.87	74.00	-16.13	peak

- Note:
1. Measurement = Reading Level + Correct Factor.
 2. If Peak Result complies with AV limit, AV Result is deemed to comply with AV limit.
 3. Peak: Peak detector.
 4. Only the worst data was recorded, if it complies with the limit, the other emissions deemed to comply with the limit.



AVG

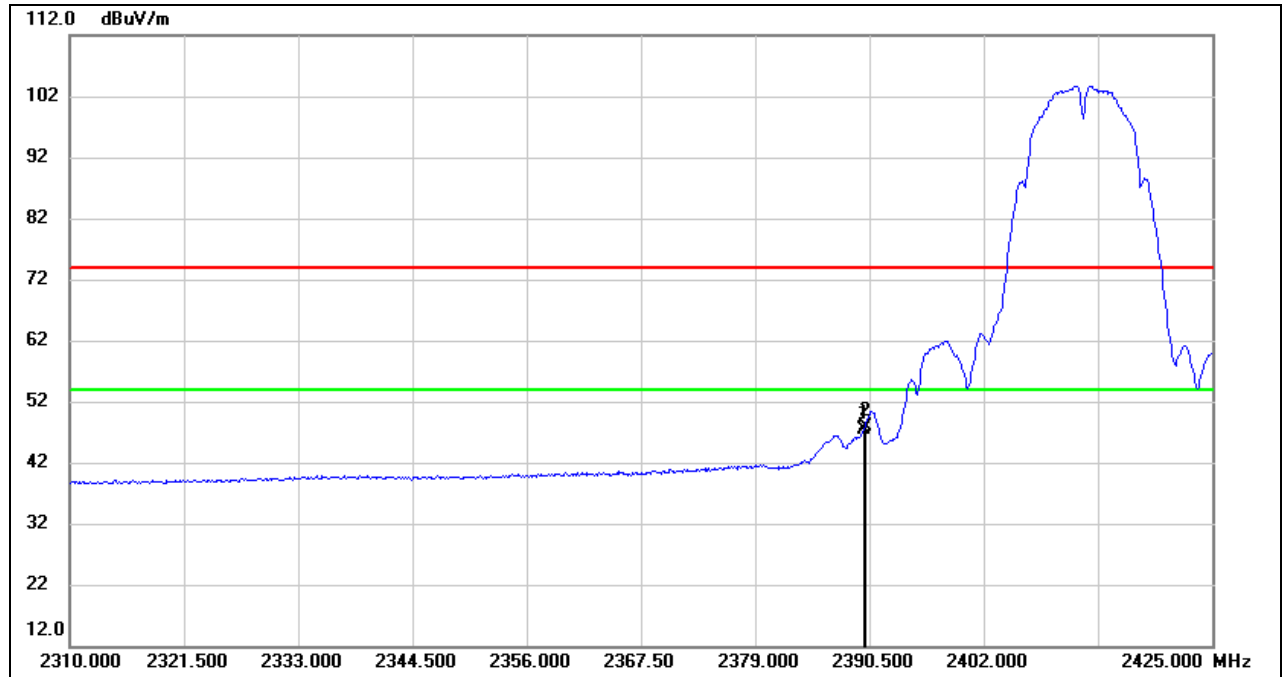

No.	Frequency (MHz)	Reading (dBuV)	Correct (dB/m)	Result (dBuV/m)	Limit (dBuV/m)	Margin (dB)	Remark
1	2389.925	14.05	33.35	47.40	54.00	-6.60	AVG
2	2390.000	14.50	33.35	47.85	54.00	-6.15	AVG

- Note:
1. Measurement = Reading Level + Correct Factor.
 2. If Peak Result complies with AV limit, AV Result is deemed to comply with AV limit.
 3. AVG: $VBW=1/Ton$, where: Ton is the transmitting duration.
 4. For the transmitting duration, please refer to clause 7.1.
 5. Only the worst data was recorded, if it complies with the limit, the other emissions deemed to comply with the limit.

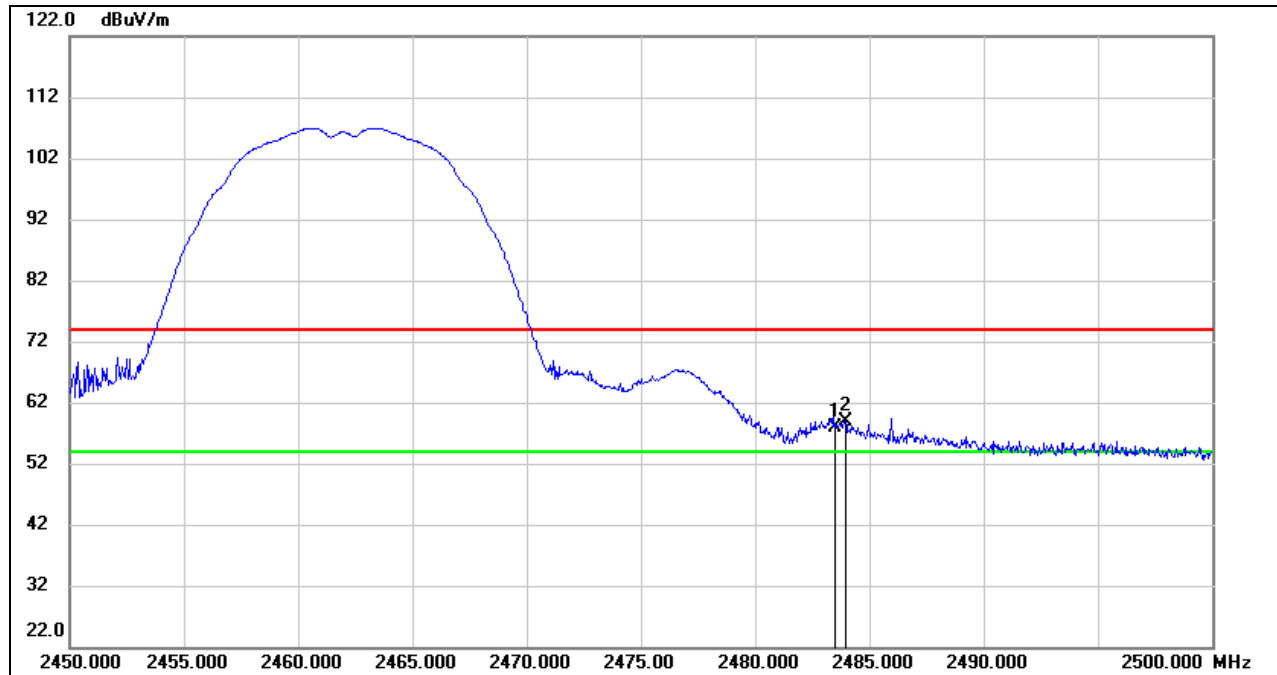
**RESTRICTED BANDEDGE (HIGH CHANNEL, VERTICAL)****PEAK**

No.	Frequency (MHz)	Reading (dBuV)	Correct (dB/m)	Result (dBuV/m)	Limit (dBuV/m)	Margin (dB)	Remark
1	2483.500	24.14	33.71	57.85	74.00	-16.15	peak
2	2483.950	25.24	33.71	58.95	74.00	-15.05	peak

- Note: 1. Measurement = Reading Level + Correct Factor.
 2. If Peak Result complies with AV limit, AV Result is deemed to comply with AV limit.
 3. Peak: Peak detector.
 4. Only the worst data was recorded, if it complies with the limit, the other emissions deemed to comply with the limit.

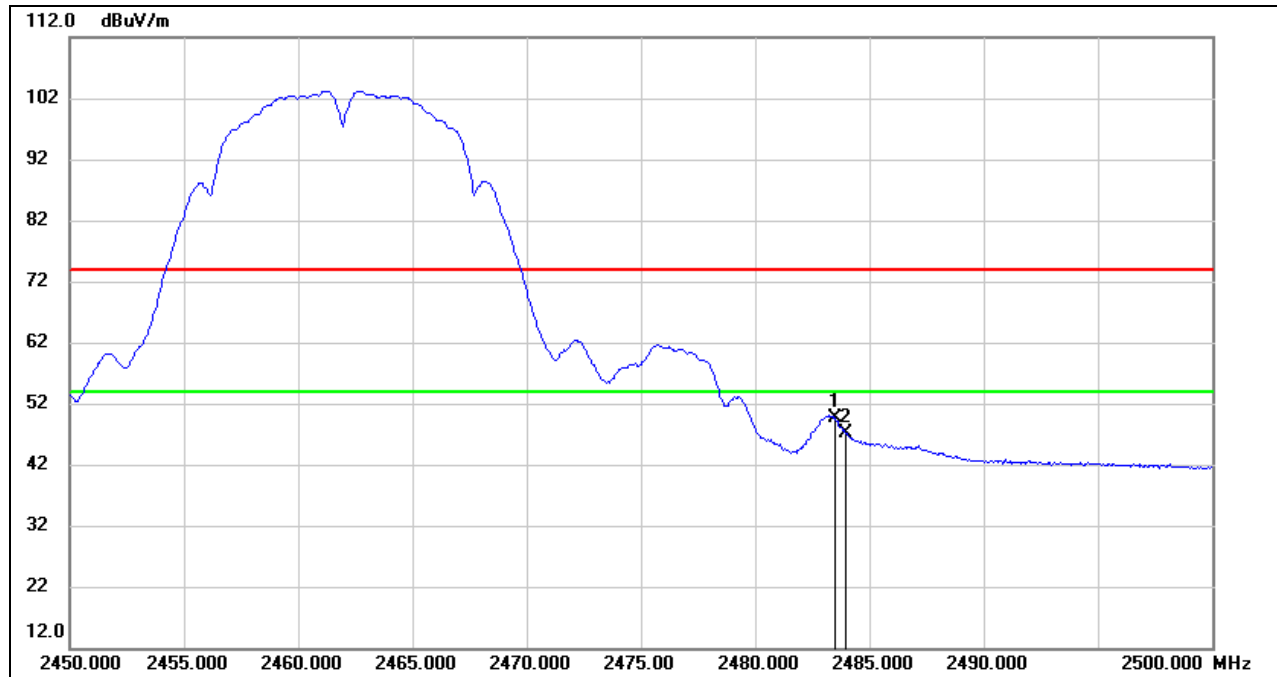
AVG

No.	Frequency (MHz)	Reading (dBuV)	Correct (dB/m)	Result (dBuV/m)	Limit (dBuV/m)	Margin (dB)	Remark
1	2483.500	15.81	33.71	49.52	54.00	-4.48	AVG
2	2483.950	13.44	33.71	47.15	54.00	-6.85	AVG

- Note:
1. Measurement = Reading Level + Correct Factor.
 2. If Peak Result complies with AV limit, AV Result is deemed to comply with AV limit.
 3. AVG: $VBW=1/T_{on}$, where: T_{on} is the transmitting duration.
 4. For the transmitting duration, please refer to clause 7.1.
 5. Only the worst data was recorded, if it complies with the limit, the other emissions deemed to comply with the limit.

8.1.2. 802.11g SISO MODE

RESTRICTED BANDEDGE (LOW CHANNEL, VERTICAL)

PEAK

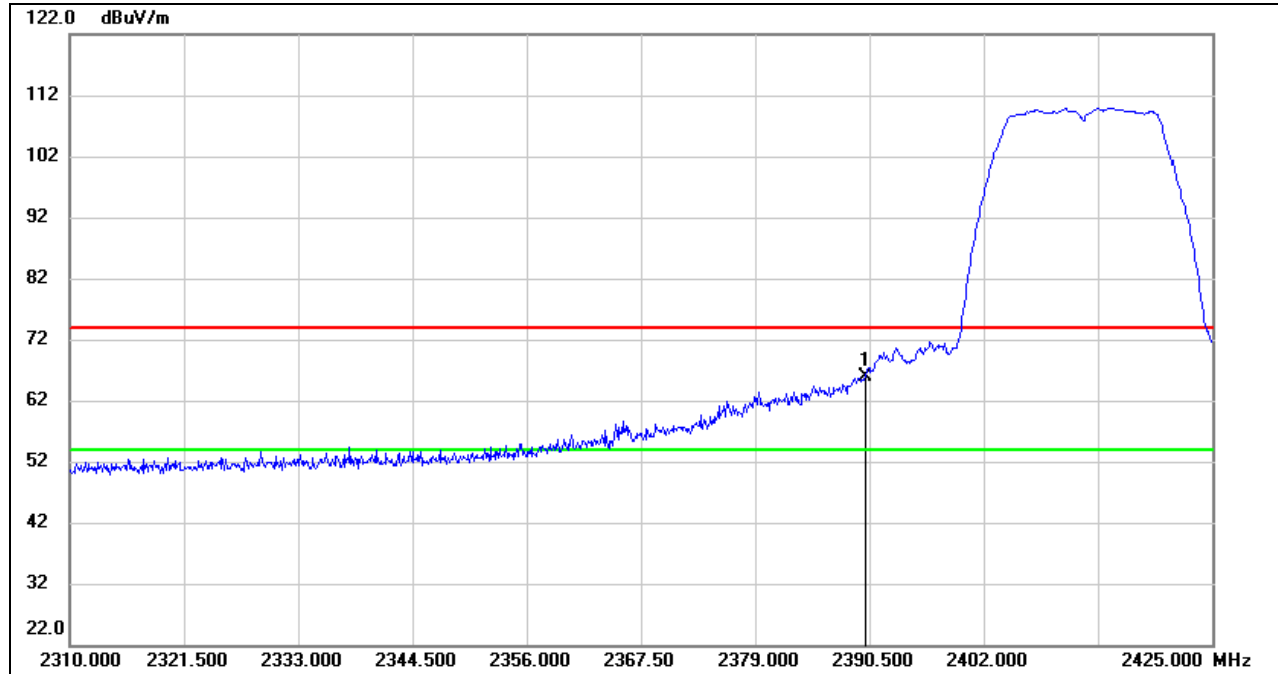

No.	Frequency (MHz)	Reading (dBuV)	Correct (dB/m)	Result (dBuV/m)	Limit (dBuV/m)	Margin (dB)	Remark
1	2390.000	32.61	33.35	65.96	74.00	-8.04	peak

- Note:
1. Measurement = Reading Level + Correct Factor.
 2. If Peak Result complies with AV limit, AV Result is deemed to comply with AV limit.
 3. Peak: Peak detector.
 4. Only the worst data was recorded, if it complies with the limit, the other emissions deemed to comply with the limit.



AVG

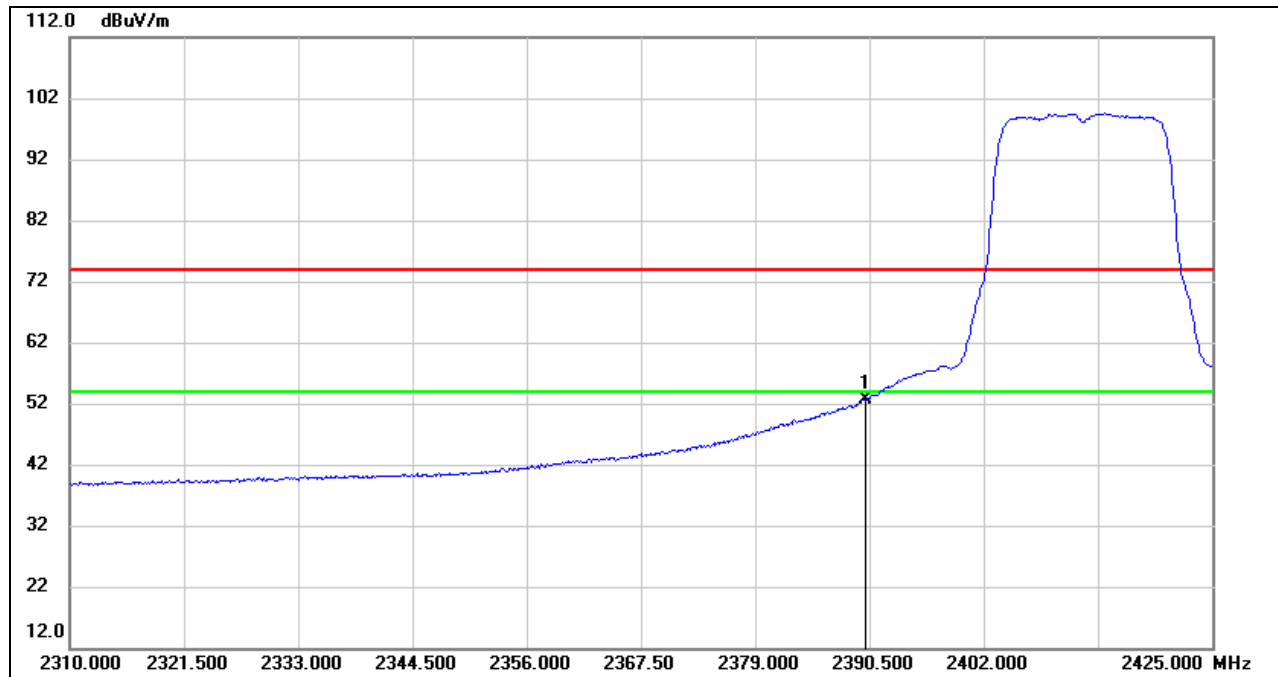

No.	Frequency (MHz)	Reading (dBuV)	Correct (dB/m)	Result (dBuV/m)	Limit (dBuV/m)	Margin (dB)	Remark
1	2390.000	19.19	33.35	52.54	54.00	-1.46	AVG

- Note:
1. Measurement = Reading Level + Correct Factor.
 2. If Peak Result complies with AV limit, AV Result is deemed to comply with AV limit.
 3. AVG: $VBW=1/Ton$, where: Ton is the transmitting duration.
 4. For the transmitting duration, please refer to clause 7.1.
 5. Only the worst data was recorded, if it complies with the limit, the other emissions deemed to comply with the limit.



RESTRICTED BANDEDGE (HIGH CHANNEL, VERTICAL)

PEAK

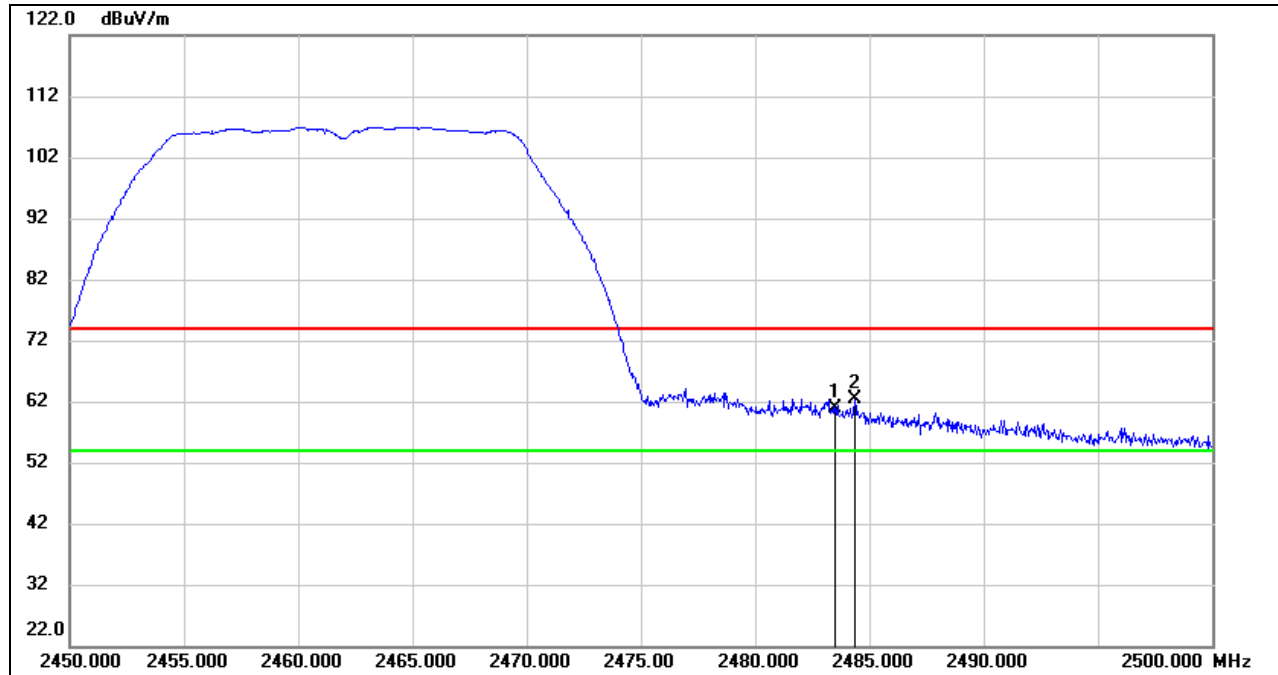

No.	Frequency (MHz)	Reading (dBuV)	Correct (dB/m)	Result (dBuV/m)	Limit (dBuV/m)	Margin (dB)	Remark
1	2483.500	27.21	33.71	60.92	74.00	-13.08	peak
2	2484.350	28.56	33.71	62.27	74.00	-11.73	peak

- Note: 1. Measurement = Reading Level + Correct Factor.
 2. If Peak Result complies with AV limit, AV Result is deemed to comply with AV limit.
 3. Peak: Peak detector.
 4. Only the worst data was recorded, if it complies with the limit, the other emissions deemed to comply with the limit.



AVG

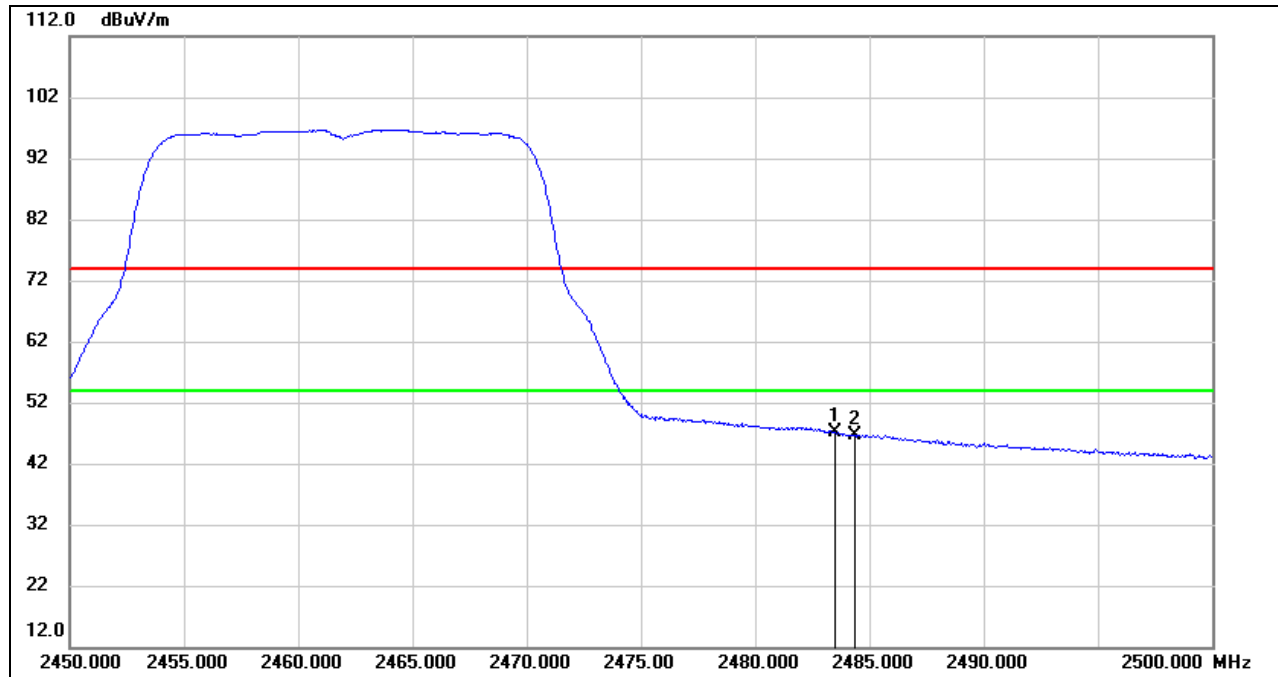

No.	Frequency (MHz)	Reading (dBuV)	Correct (dB/m)	Result (dBuV/m)	Limit (dBuV/m)	Margin (dB)	Remark
1	2483.500	13.40	33.71	47.11	54.00	-6.89	AVG
2	2484.350	12.97	33.71	46.68	54.00	-7.32	AVG

- Note: 1. Measurement = Reading Level + Correct Factor.
 2. If Peak Result complies with AV limit, AV Result is deemed to comply with AV limit.
 3. AVG: $VBW=1/Ton$, where: Ton is the transmitting duration.
 4. For the transmitting duration, please refer to clause 7.1.
 5. Only the worst data was recorded, if it complies with the limit, the other emissions deemed to comply with the limit

8.1.3. 802.11n HT20 MIMO MODE

RESTRICTED BANDEDGE (LOW CHANNEL, VERTICAL)

PEAK

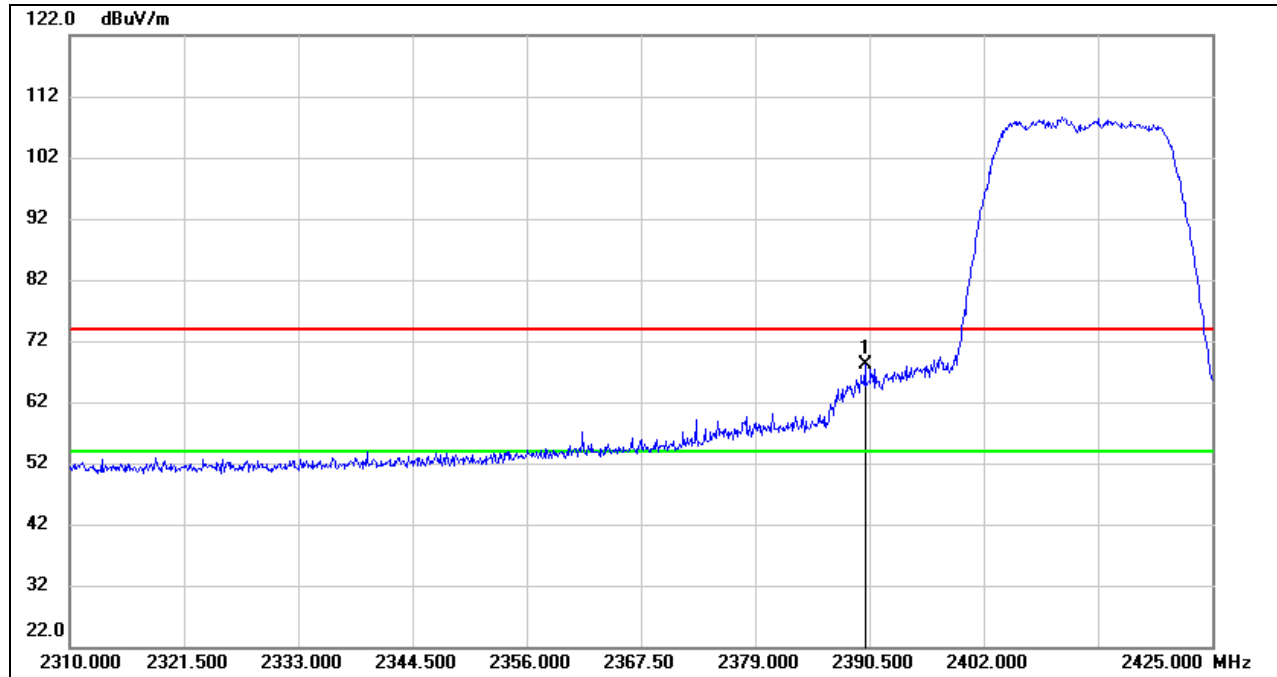

No.	Frequency (MHz)	Reading (dBuV)	Correct (dB/m)	Result (dBuV/m)	Limit (dBuV/m)	Margin (dB)	Remark
1	2390.000	34.79	33.35	68.14	74.00	-5.86	peak

- Note:
1. Measurement = Reading Level + Correct Factor.
 2. If Peak Result complies with AV limit, AV Result is deemed to comply with AV limit.
 3. Peak: Peak detector.
 4. Only the worst data was recorded, if it complies with the limit, the other emissions deemed to comply with the limit.



AVG

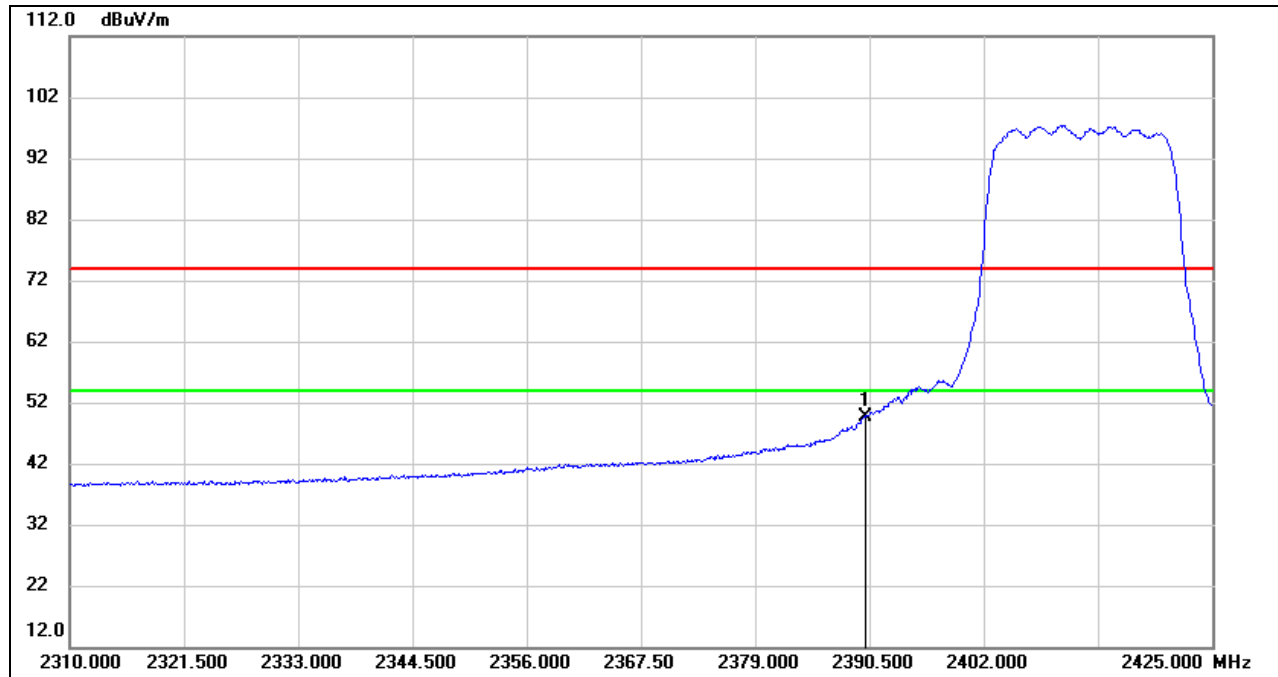

No.	Frequency (MHz)	Reading (dBuV)	Correct (dB/m)	Result (dBuV/m)	Limit (dBuV/m)	Margin (dB)	Remark
1	2390.000	16.38	33.35	49.73	54.00	-4.27	AVG

- Note:
1. Measurement = Reading Level + Correct Factor.
 2. If Peak Result complies with AV limit, AV Result is deemed to comply with AV limit.
 3. AVG: $VBW=1/Ton$, where: Ton is the transmitting duration.
 4. For the transmitting duration, please refer to clause 7.1.
 5. Only the worst data was recorded, if it complies with the limit, the other emissions deemed to comply with the limit.



RESTRICTED BANDEDGE (HIGH CHANNEL, VERTICAL)

PEAK

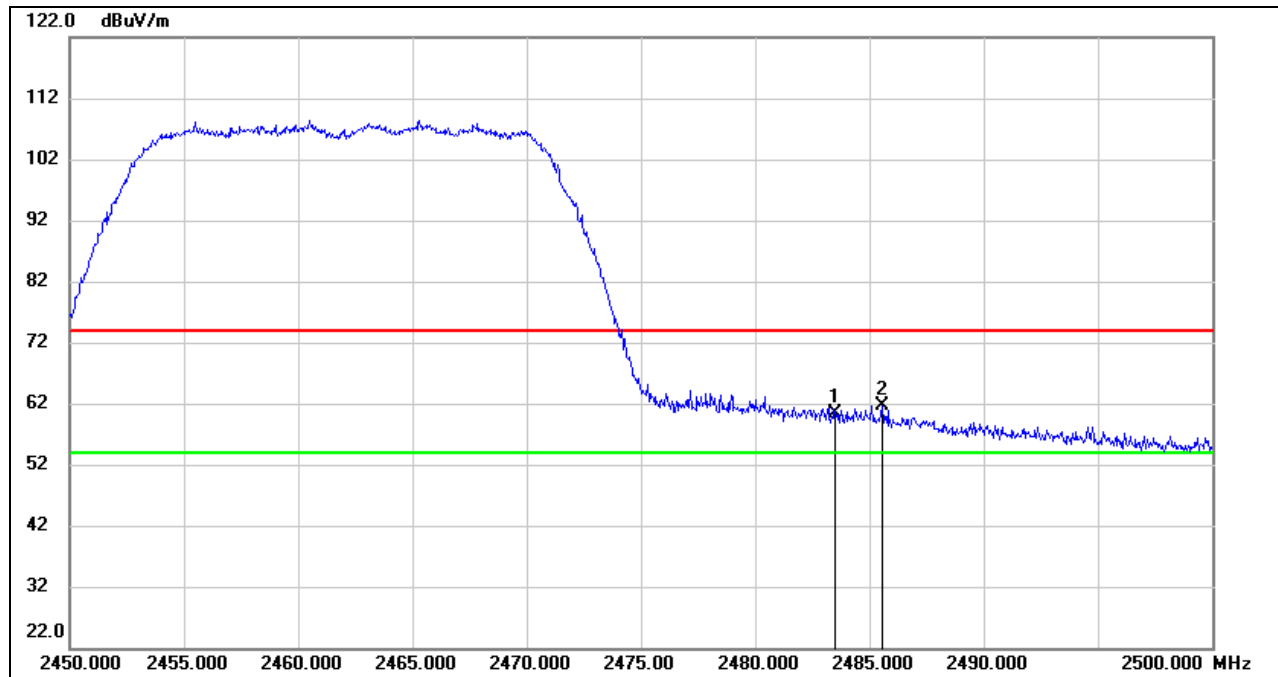

No.	Frequency (MHz)	Reading (dBuV)	Correct (dB/m)	Result (dBuV/m)	Limit (dBuV/m)	Margin (dB)	Remark
1	2483.500	26.59	33.71	60.30	74.00	-13.70	peak
2	2485.550	27.99	33.71	61.70	74.00	-12.30	peak

- Note: 1. Measurement = Reading Level + Correct Factor.
 2. If Peak Result complies with AV limit, AV Result is deemed to comply with AV limit.
 3. Peak: Peak detector.
 4. Only the worst data was recorded, if it complies with the limit, the other emissions deemed to comply with the limit.



AVG

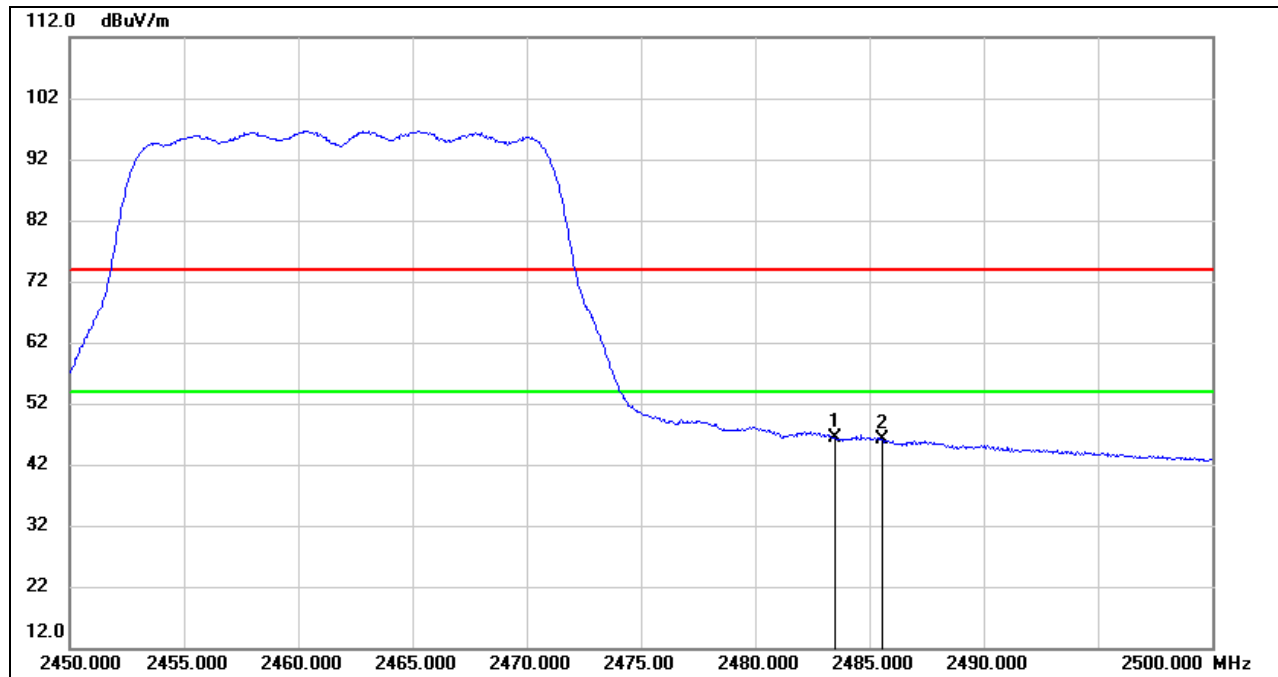

No.	Frequency (MHz)	Reading (dBuV)	Correct (dB/m)	Result (dBuV/m)	Limit (dBuV/m)	Margin (dB)	Remark
1	2483.500	12.65	33.71	46.36	54.00	-7.64	AVG
2	2485.550	12.41	33.71	46.12	54.00	-7.88	AVG

- Note: 1. Measurement = Reading Level + Correct Factor.
 2. If Peak Result complies with AV limit, AV Result is deemed to comply with AV limit.
 3. AVG: $VBW=1/Ton$, where: Ton is the transmitting duration.
 4. For the transmitting duration, please refer to clause 7.1.
 5. Only the worst data was recorded, if it complies with the limit, the other emissions deemed to comply with the limit.

Note: All the polarities (vertical and horizontal) had been tested, only the worst data was recorded in the report.

8.2. SPURIOUS EMISSIONS (1 GHz ~ 3 GHz)

8.2.1. 802.11g SISO MODE

HARMONICS AND SPURIOUS EMISSIONS (LOW CHANNEL, HORIZONTAL)

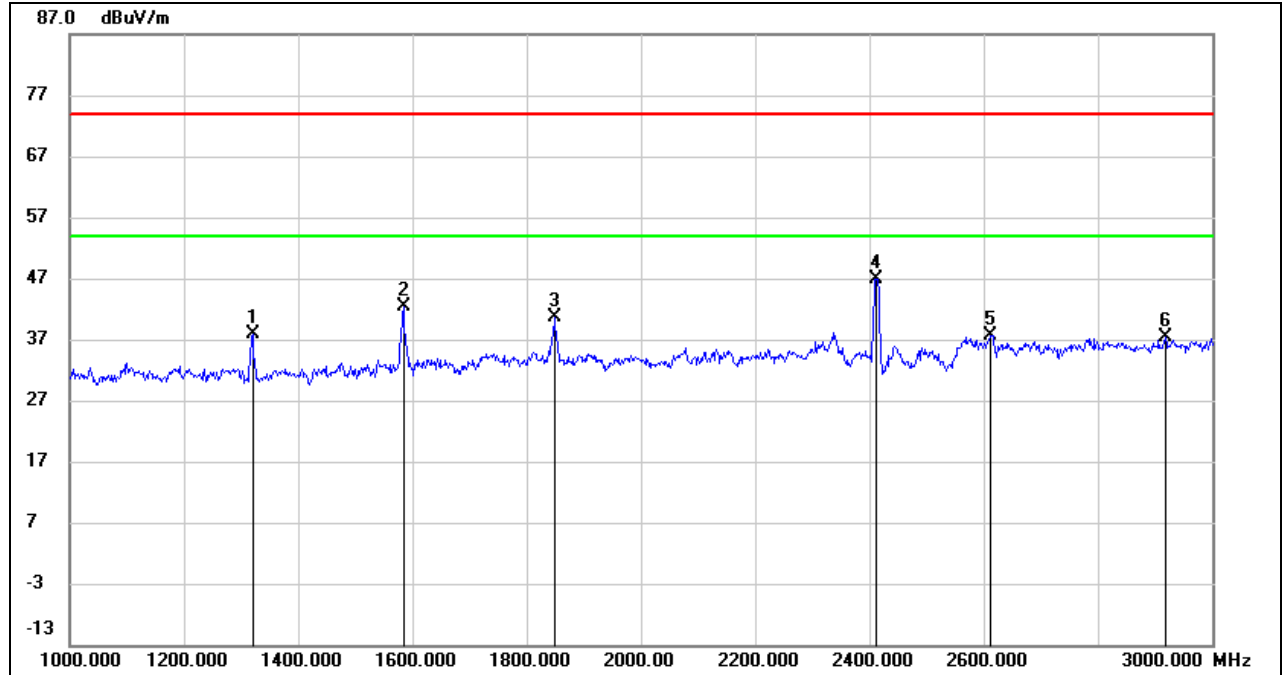

No.	Frequency (MHz)	Reading (dBuV)	Correct (dB/m)	Result (dBuV/m)	Limit (dBuV/m)	Margin (dB)	Remark
1	1320.000	50.68	-12.82	37.86	74.00	-36.14	peak
2	1584.000	54.01	-11.66	42.35	74.00	-31.65	peak
3	1848.000	50.74	-10.09	40.65	74.00	-33.35	peak
4	2412.000	55.25	-8.37	46.88	74.00	-27.12	peak
5	2612.000	45.52	-7.79	37.73	74.00	-36.27	peak
6	2918.000	43.34	-5.99	37.35	74.00	-36.65	peak

- Note: 1. Measurement = Reading Level + Correct Factor.
 2. If Peak Result complies with AV limit, AV Result is deemed to comply with AV limit.
 3. Peak: Peak detector
 4. The Band Reject filter loss factor already add into the correct factor.
 5. Proper operation of the transmitter prior to adding the filter to the measurement chain.

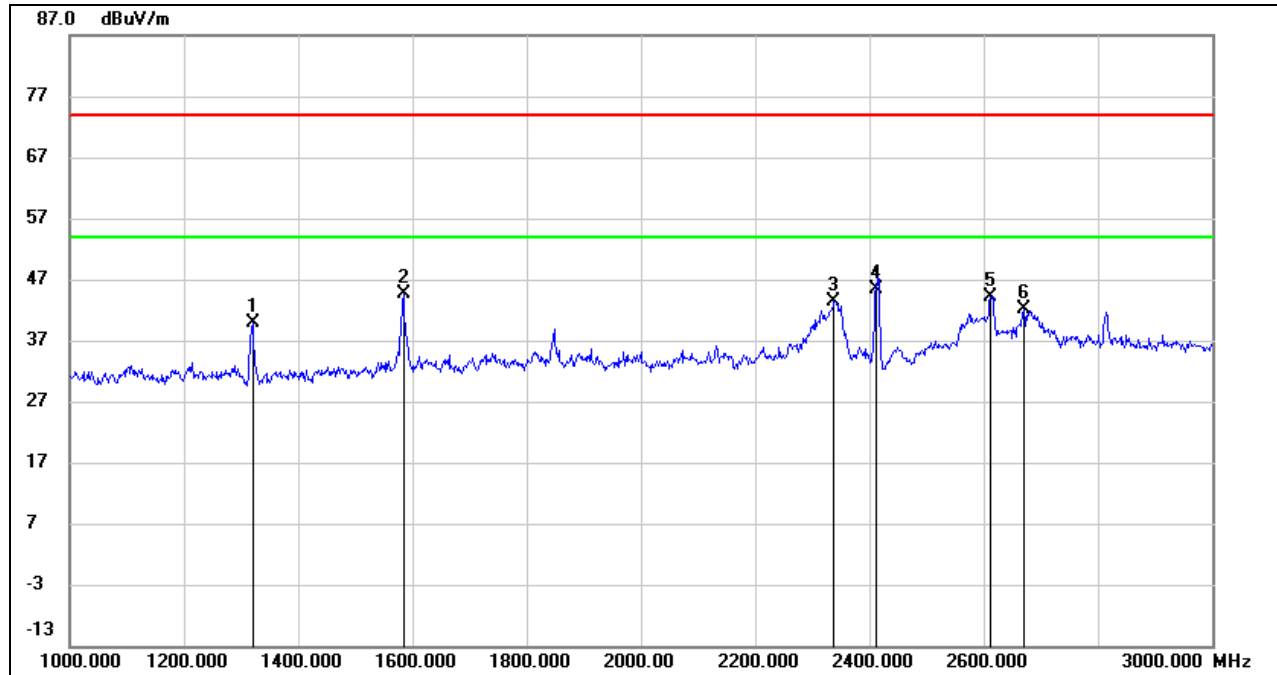
**HARMONICS AND SPURIOUS EMISSIONS (LOW CHANNEL, VERTICAL)**

No.	Frequency (MHz)	Reading (dBuV)	Correct (dB/m)	Result (dBuV/m)	Limit (dBuV/m)	Margin (dB)	Remark
1	1320.000	52.75	-12.82	39.93	74.00	-34.07	peak
2	1584.000	56.23	-11.66	44.57	74.00	-29.43	peak
3	2338.000	52.06	-8.60	43.46	74.00	-30.54	peak
4	2412.000	53.71	-8.37	45.34	74.00	-28.66	peak
5	2612.000	51.97	-7.79	44.18	74.00	-29.82	peak
6	2670.000	49.42	-7.41	42.01	74.00	-31.99	peak

- Note: 1. Measurement = Reading Level + Correct Factor.
 2. If Peak Result complies with AV limit, AV Result is deemed to comply with AV limit.
 3. Peak: Peak detector.
 4. The Band Reject filter loss factor already add into the correct factor.
 5. Proper operation of the transmitter prior to adding the filter to the measurement chain.

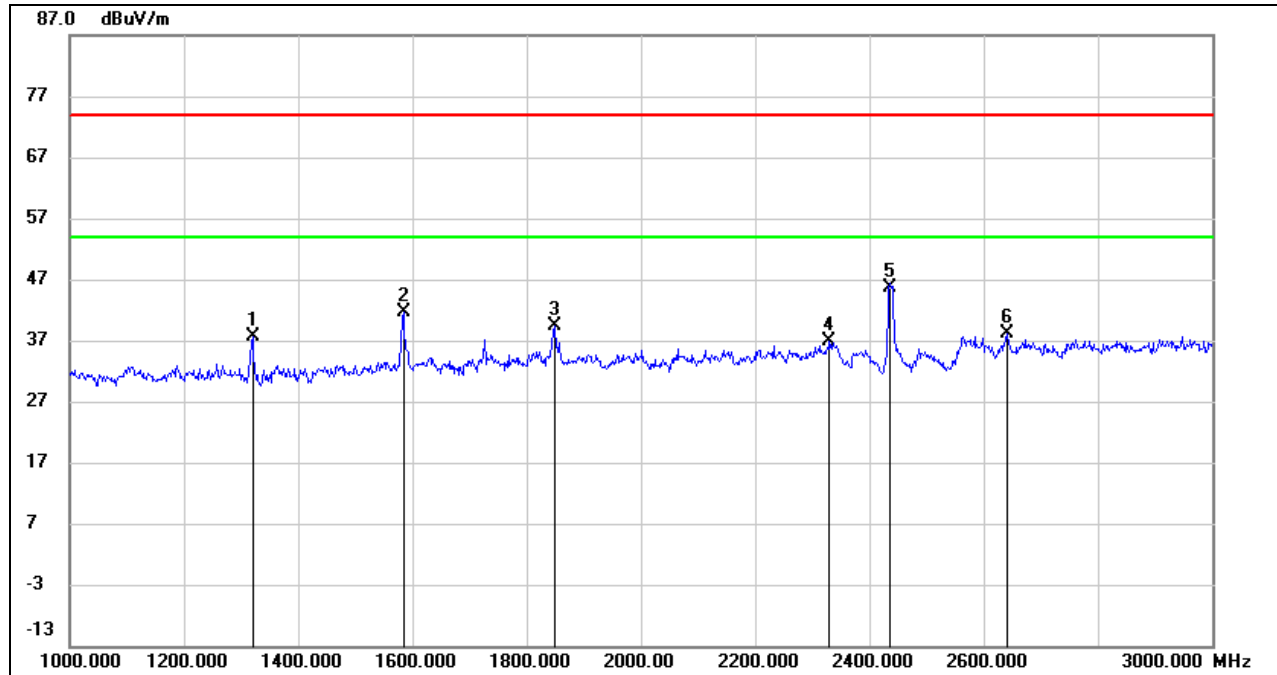
**HARMONICS AND SPURIOUS EMISSIONS (MID CHANNEL, HORIZONTAL)**

No.	Frequency (MHz)	Reading (dBuV)	Correct (dB/m)	Result (dBuV/m)	Limit (dBuV/m)	Margin (dB)	Remark
1	1320.000	50.34	-12.82	37.52	74.00	-36.48	peak
2	1584.000	53.25	-11.66	41.59	74.00	-32.41	peak
3	1848.000	49.42	-10.09	39.33	74.00	-34.67	peak
4	2330.000	45.45	-8.63	36.82	74.00	-37.18	peak
5	2437.000	53.96	-8.33	45.63	74.00	-28.37	peak
6	2640.000	45.76	-7.61	38.15	74.00	-35.85	peak

- Note: 1. Measurement = Reading Level + Correct Factor.
 2. If Peak Result complies with AV limit, AV Result is deemed to comply with AV limit.
 3. Peak: Peak detector.
 4. The Band Reject filter loss factor already add into the correct factor.
 5. Proper operation of the transmitter prior to adding the filter to the measurement chain.

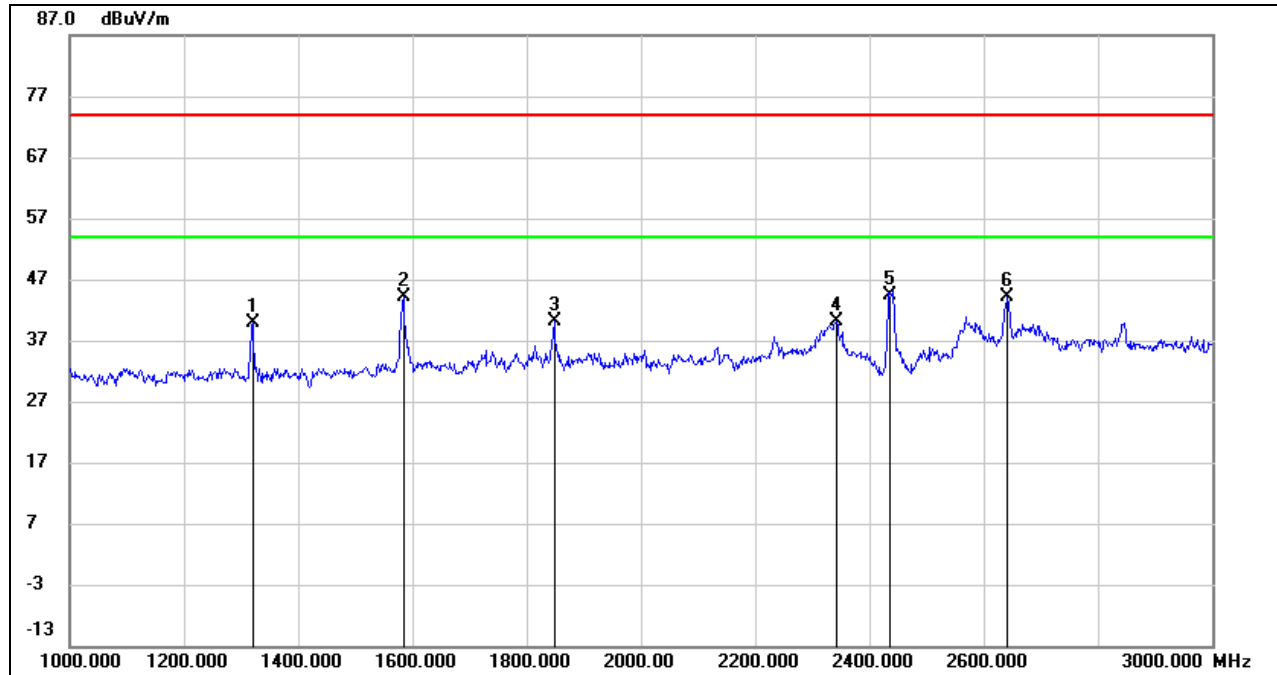
**HARMONICS AND SPURIOUS EMISSIONS (MID CHANNEL, VERTICAL)**

No.	Frequency (MHz)	Reading (dBuV)	Correct (dB/m)	Result (dBuV/m)	Limit (dBuV/m)	Margin (dB)	Remark
1	1320.000	52.61	-12.82	39.79	74.00	-34.21	peak
2	1584.000	55.70	-11.66	44.04	74.00	-29.96	peak
3	1848.000	50.20	-10.09	40.11	74.00	-33.89	peak
4	2342.000	48.74	-8.58	40.16	74.00	-33.84	peak
5	2437.000	52.62	-8.33	44.29	74.00	-29.71	peak
6	2642.000	51.66	-7.59	44.07	74.00	-29.93	peak

- Note: 1. Measurement = Reading Level + Correct Factor.
 2. If Peak Result complies with AV limit, AV Result is deemed to comply with AV limit.
 3. Peak: Peak detector.
 4. The Band Reject filter loss factor already add into the correct factor.
 5. Proper operation of the transmitter prior to adding the filter to the measurement chain.

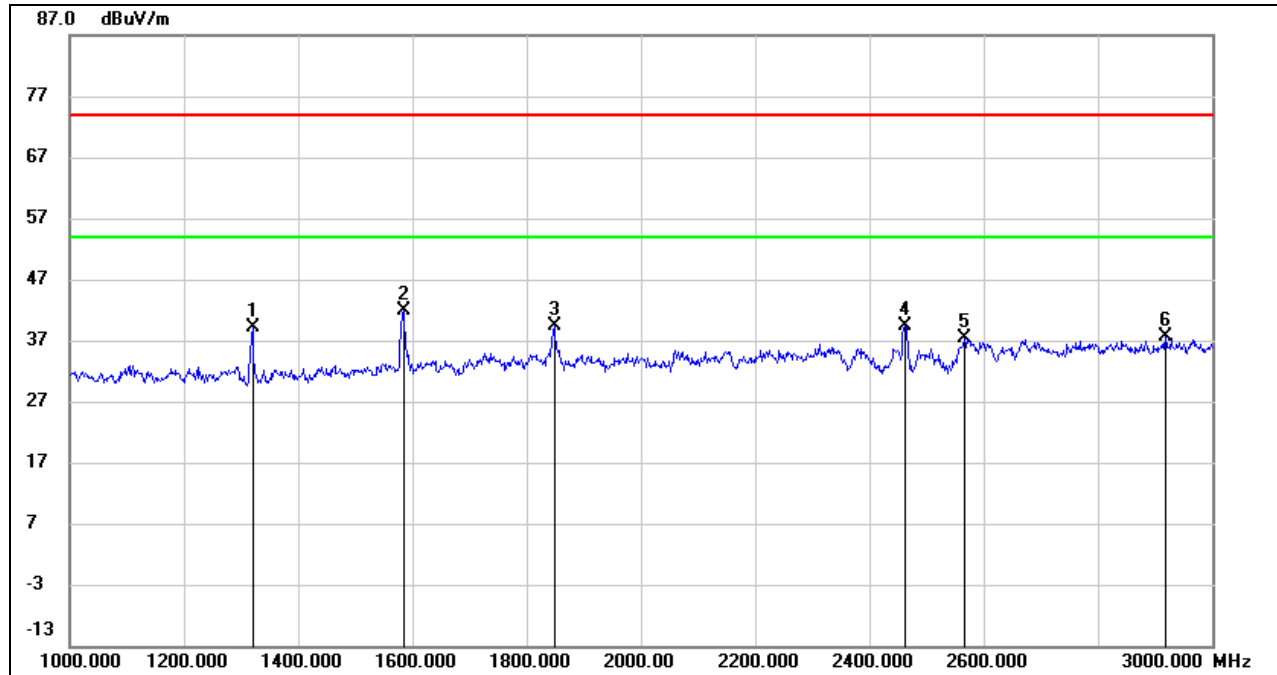
HARMONICS AND SPURIOUS EMISSIONS (HIGH CHANNEL, HORIZONTAL)

No.	Frequency (MHz)	Reading (dBuV)	Correct (dB/m)	Result (dBuV/m)	Limit (dBuV/m)	Margin (dB)	Remark
1	1320.000	51.87	-12.82	39.05	74.00	-34.95	peak
2	1584.000	53.61	-11.66	41.95	74.00	-32.05	peak
3	1848.000	49.53	-10.09	39.44	74.00	-34.56	peak
4	2462.000	47.78	-8.29	39.49	74.00	-34.51	peak
5	2566.000	45.35	-7.99	37.36	74.00	-36.64	peak
6	2918.000	43.70	-5.99	37.71	74.00	-36.29	peak

- Note:
1. Measurement = Reading Level + Correct Factor.
 2. If Peak Result complies with AV limit, AV Result is deemed to comply with AV limit.
 3. Peak: Peak detector.
 4. The Band Reject filter loss factor already add into the correct factor.
 5. Proper operation of the transmitter prior to adding the filter to the measurement chain.

HARMONICS AND SPURIOUS EMISSIONS (HIGH CHANNEL, VERTICAL)

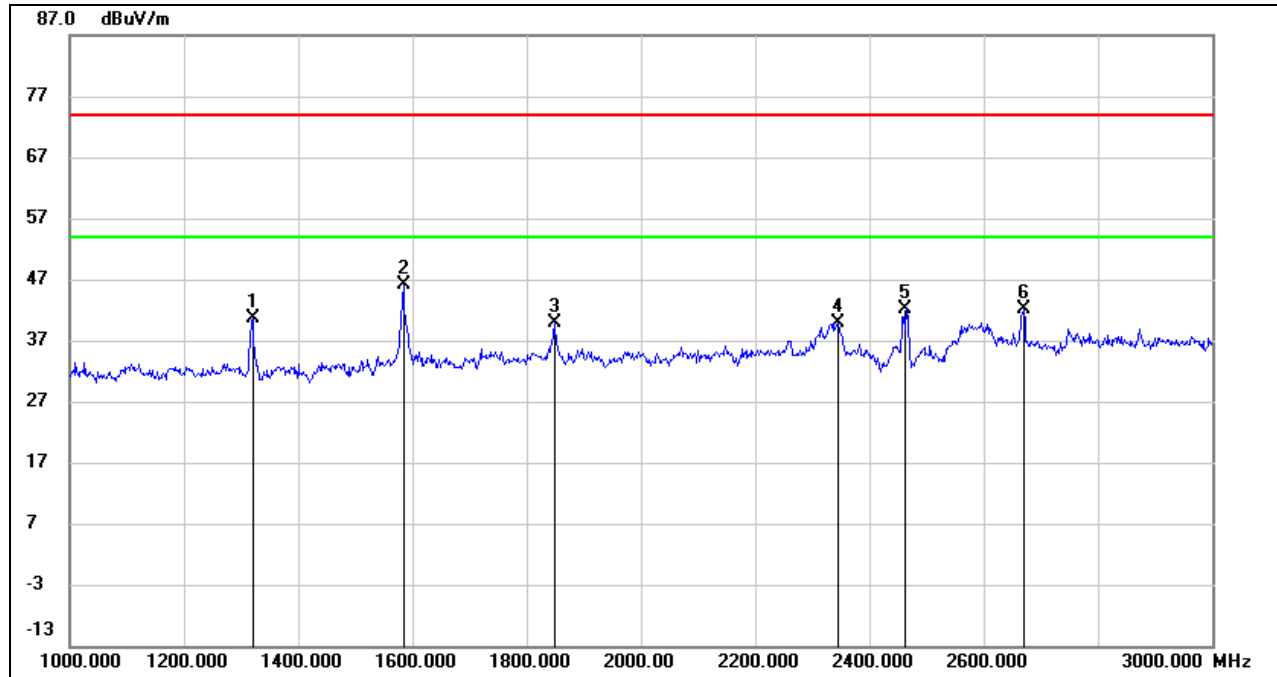

No.	Frequency (MHz)	Reading (dBuV)	Correct (dB/m)	Result (dBuV/m)	Limit (dBuV/m)	Margin (dB)	Remark
1	1320.000	53.38	-12.82	40.56	74.00	-33.44	peak
2	1584.000	57.67	-11.66	46.01	74.00	-27.99	peak
3	1848.000	50.00	-10.09	39.91	74.00	-34.09	peak
4	2344.000	48.55	-8.58	39.97	74.00	-34.03	peak
5	2462.000	50.44	-8.29	42.15	74.00	-31.85	peak
6	2670.000	49.57	-7.41	42.16	74.00	-31.84	peak

- Note: 1. Measurement = Reading Level + Correct Factor.
 2. If Peak Result complies with AV limit, AV Result is deemed to comply with AV limit.
 3. Peak: Peak detector.
 4. The Band Reject filter loss factor already add into the correct factor.
 5. Proper operation of the transmitter prior to adding the filter to the measurement chain.

Note: All the modes and channels had been tested, but only the worst data was recorded in the report.

8.3. SPURIOUS EMISSIONS (3 GHz ~ 18 GHz)

8.3.1. 802.11b SISO MODE

HARMONICS AND SPURIOUS EMISSIONS (LOW CHANNEL, HORIZONTAL)

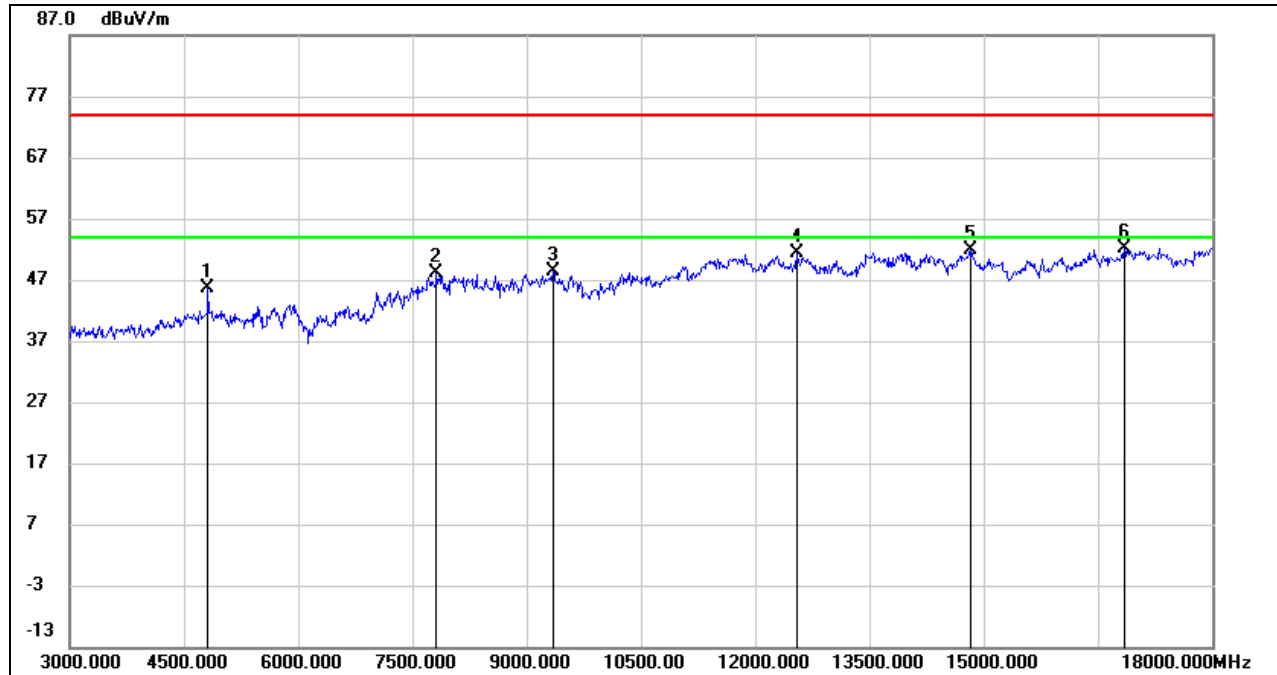

No.	Frequency (MHz)	Reading (dBuV)	Correct (dB/m)	Result (dBuV/m)	Limit (dBuV/m)	Margin (dB)	Remark
1	4815.000	44.13	1.38	45.51	74.00	-28.49	peak
2	7815.000	38.82	9.28	48.10	74.00	-25.90	peak
3	9345.000	37.69	10.66	48.35	74.00	-25.65	peak
4	12540.000	35.62	15.72	51.34	74.00	-22.66	peak
5	14820.000	33.99	17.91	51.90	74.00	-22.10	peak
6	16845.000	30.96	21.10	52.06	74.00	-21.94	peak

- Note: 1. Peak Result = Reading Level + Correct Factor.
 2. If Peak Result complies with AV limit, AV Result is deemed to comply with AV limit.
 3. Peak: Peak detector.
 4. Filter losses were only considered in the spurious frequency bands and the authorized band was not corrected for High Pass Filter losses.
 5. Proper operation of the transmitter prior to adding the filter to the measurement chain.

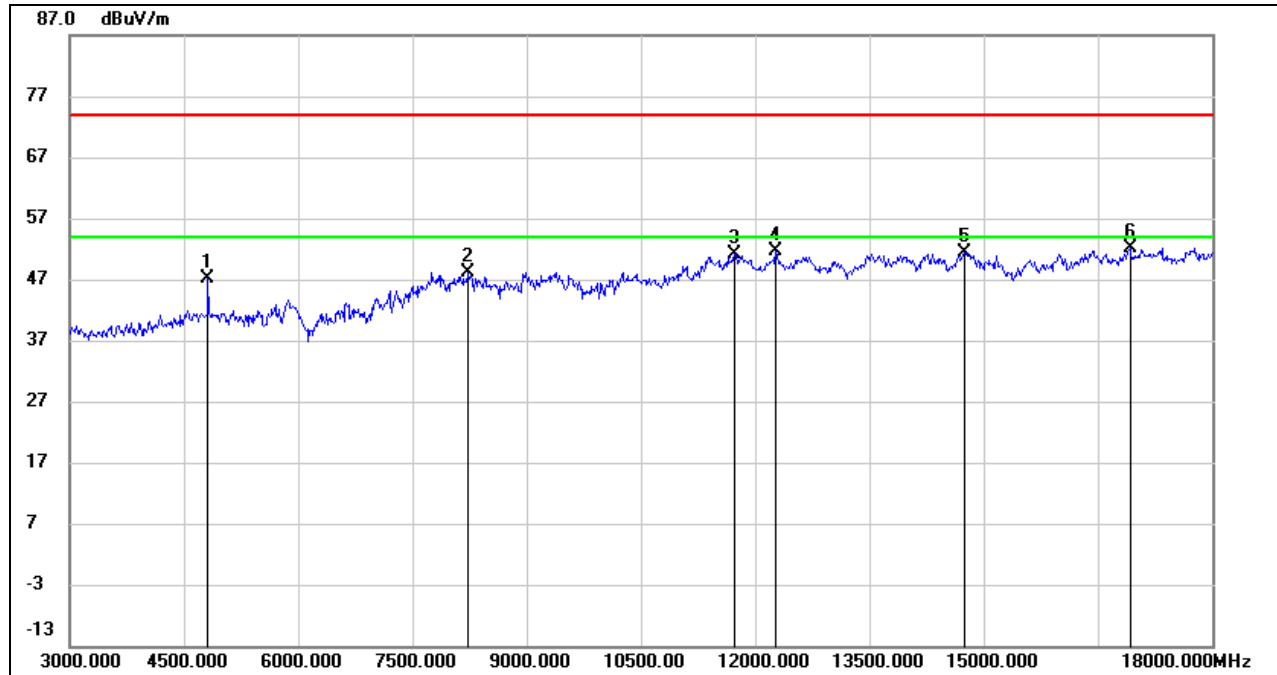
**HARMONICS AND SPURIOUS EMISSIONS (LOW CHANNEL, VERTICAL)**

No.	Frequency (MHz)	Reading (dBuV)	Correct (dB/m)	Result (dBuV/m)	Limit (dBuV/m)	Margin (dB)	Remark
1	4815.000	45.74	1.38	47.12	74.00	-26.88	peak
2	8235.000	38.42	9.76	48.18	74.00	-25.82	peak
3	11730.000	35.79	15.32	51.11	74.00	-22.89	peak
4	12270.000	35.69	16.04	51.73	74.00	-22.27	peak
5	14745.000	33.50	17.84	51.34	74.00	-22.66	peak
6	16920.000	30.57	21.51	52.08	74.00	-21.92	peak

Note: 1. Peak Result = Reading Level + Correct Factor.

2. If Peak Result complies with AV limit, AV Result is deemed to comply with AV limit.

3. Peak: Peak detector.

4. Filter losses were only considered in the spurious frequency bands and the authorized band was not corrected for High Pass Filter losses.

5. Proper operation of the transmitter prior to adding the filter to the measurement chain.

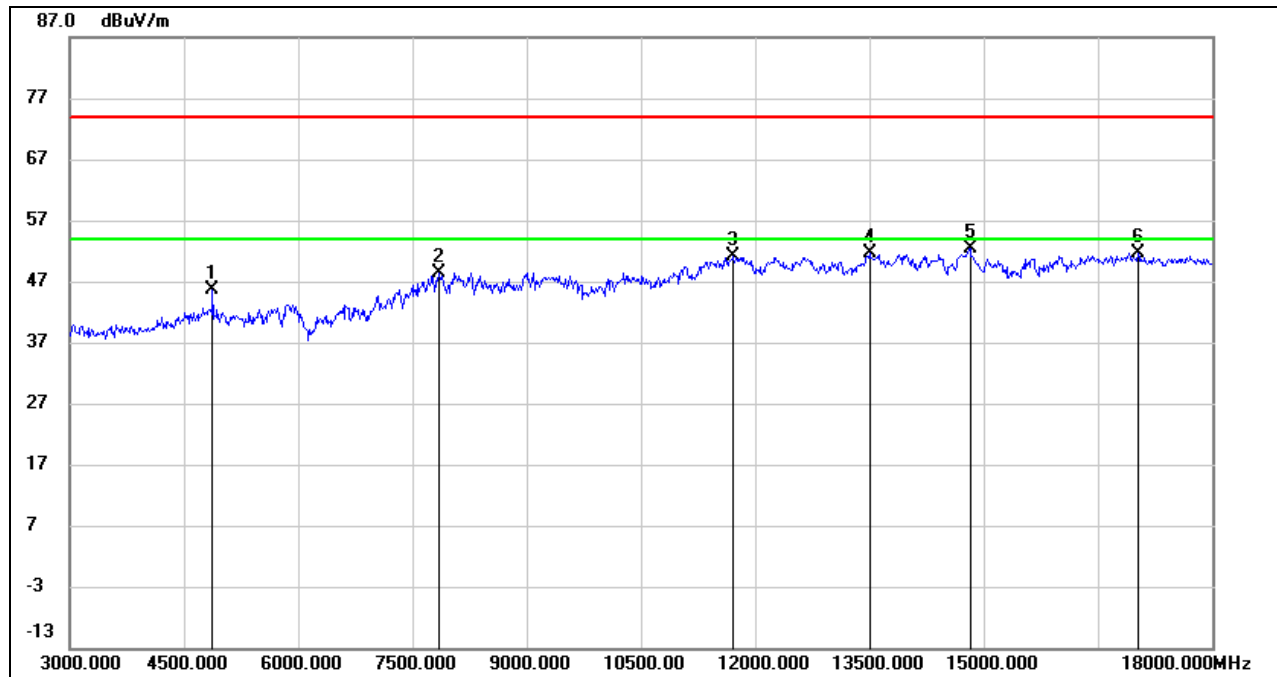
**HARMONICS AND SPURIOUS EMISSIONS (MID CHANNEL, HORIZONTAL)**

No.	Frequency (MHz)	Reading (dBuV)	Correct (dB/m)	Result (dBuV/m)	Limit (dBuV/m)	Margin (dB)	Remark
1	4875.000	44.23	1.32	45.55	74.00	-28.45	peak
2	7845.000	39.35	9.14	48.49	74.00	-25.51	peak
3	11715.000	35.71	15.34	51.05	74.00	-22.95	peak
4	13500.000	34.44	17.22	51.66	74.00	-22.34	peak
5	14820.000	34.46	17.91	52.37	74.00	-21.63	peak
6	17025.000	30.12	21.40	51.52	74.00	-22.48	peak

Note: 1. Peak Result = Reading Level + Correct Factor.

2. If Peak Result complies with AV limit, AV Result is deemed to comply with AV limit.

3. Peak: Peak detector.

4. Filter losses were only considered in the spurious frequency bands and the authorized band was not corrected for High Pass Filter losses.

5. Proper operation of the transmitter prior to adding the filter to the measurement chain.

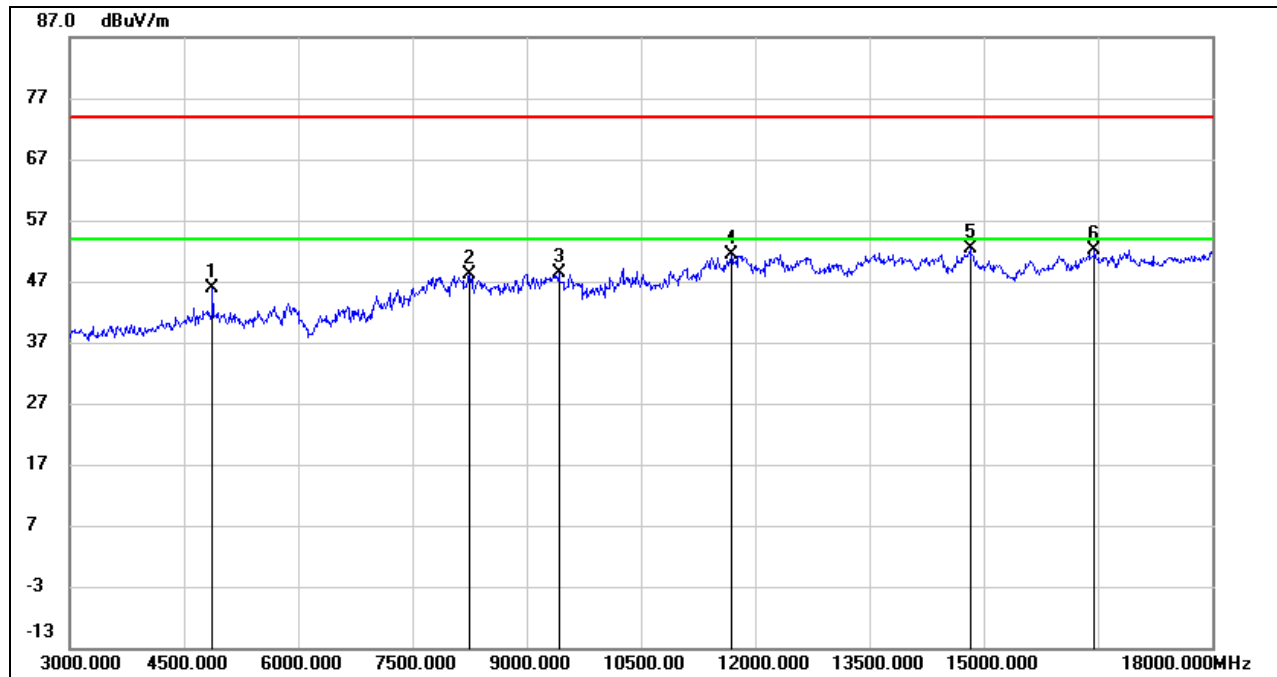
**HARMONICS AND SPURIOUS EMISSIONS (MID CHANNEL, VERTICAL)**

No.	Frequency (MHz)	Reading (dBuV)	Correct (dB/m)	Result (dBuV/m)	Limit (dBuV/m)	Margin (dB)	Remark
1	4875.000	44.62	1.32	45.94	74.00	-28.06	peak
2	8250.000	38.42	9.75	48.17	74.00	-25.83	peak
3	9420.000	37.62	10.88	48.50	74.00	-25.50	peak
4	11685.000	36.01	15.26	51.27	74.00	-22.73	peak
5	14820.000	34.56	17.91	52.47	74.00	-21.53	peak
6	16455.000	32.46	19.68	52.14	74.00	-21.86	peak

- Note: 1. Peak Result = Reading Level + Correct Factor.
 2. If Peak Result complies with AV limit, AV Result is deemed to comply with AV limit.
 3. Peak: Peak detector.
 4. Filter losses were only considered in the spurious frequency bands and the authorized band was not corrected for High Pass Filter losses.
 5. Proper operation of the transmitter prior to adding the filter to the measurement chain.

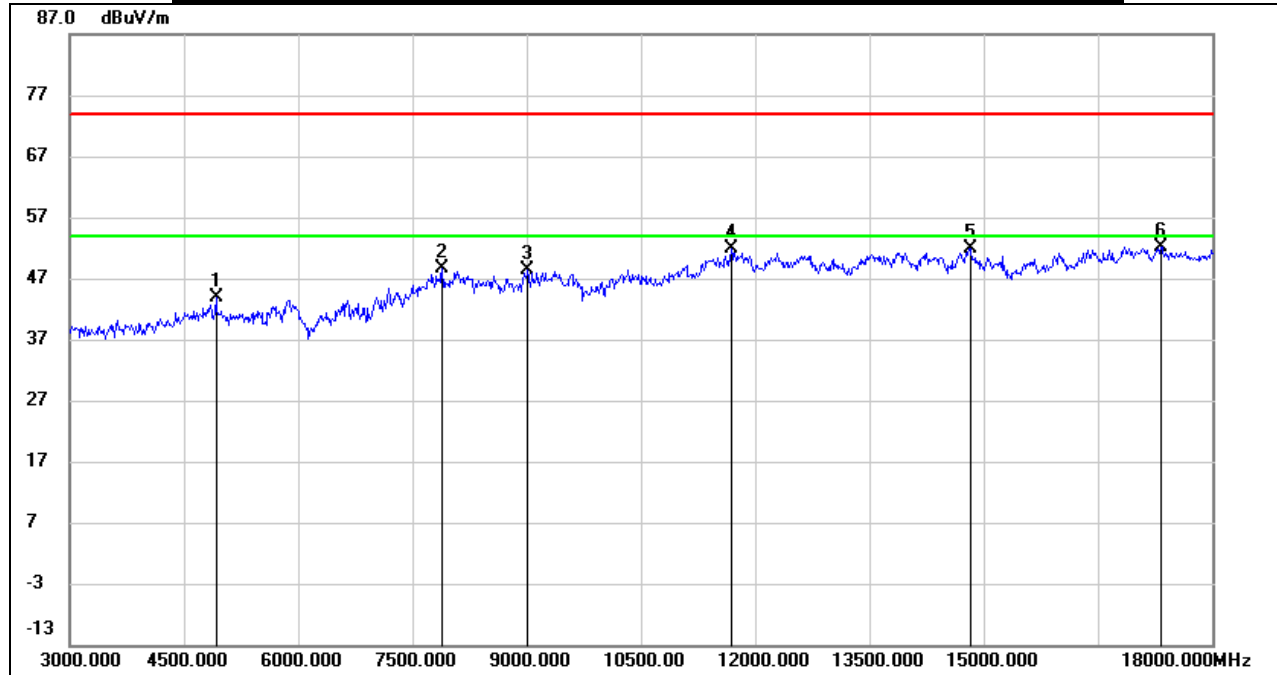
**HARMONICS AND SPURIOUS EMISSIONS (HIGH CHANNEL, HORIZONTAL)**

No.	Frequency (MHz)	Reading (dBuV)	Correct (dB/m)	Result (dBuV/m)	Limit (dBuV/m)	Margin (dB)	Remark
1	4920.000	42.35	1.45	43.80	74.00	-30.20	peak
2	7890.000	39.62	8.91	48.53	74.00	-25.47	peak
3	9015.000	37.37	11.10	48.47	74.00	-25.53	peak
4	11685.000	36.52	15.26	51.78	74.00	-22.22	peak
5	14820.000	33.97	17.91	51.88	74.00	-22.12	peak
6	17325.000	29.78	22.42	52.20	74.00	-21.80	peak

Note: 1. Peak Result = Reading Level + Correct Factor.

2. If Peak Result complies with AV limit, AV Result is deemed to comply with AV limit.

3. Peak: Peak detector.

4. Filter losses were only considered in the spurious frequency bands and the authorized band was not corrected for High Pass Filter losses.

5. Proper operation of the transmitter prior to adding the filter to the measurement chain.



HARMONICS AND SPURIOUS EMISSIONS (HIGH CHANNEL, VERTICAL)

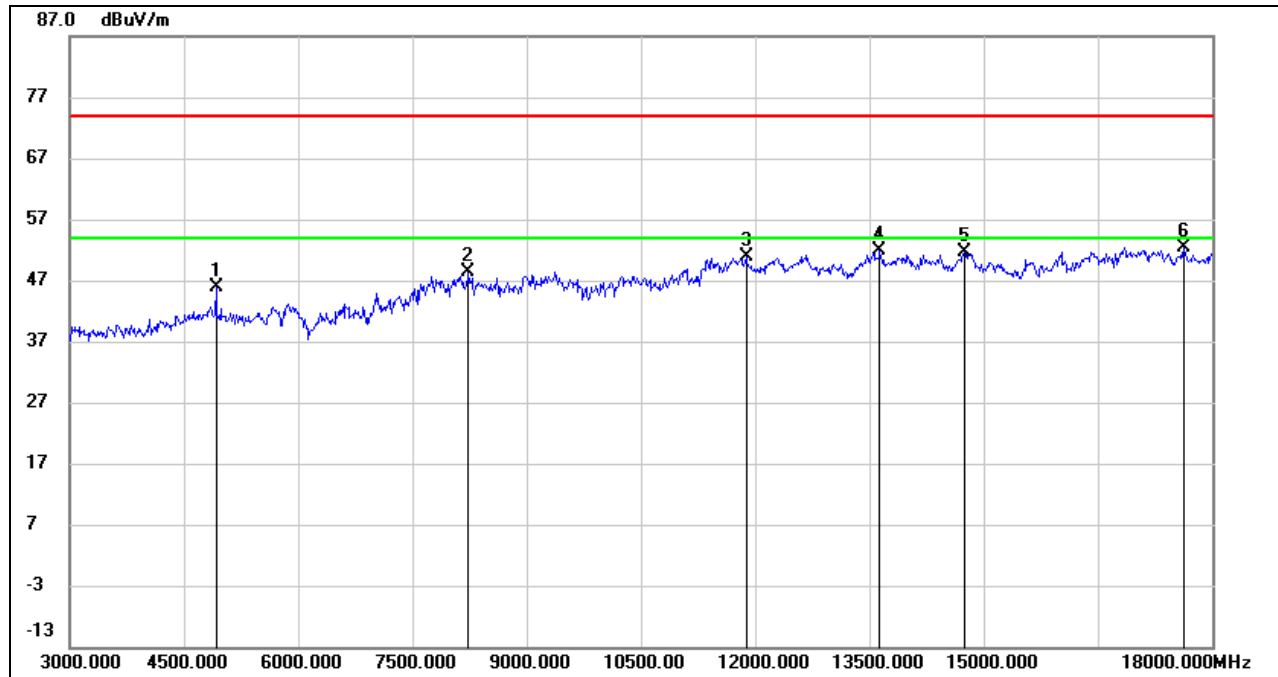

No.	Frequency (MHz)	Reading (dBuV)	Correct (dB/m)	Result (dBuV/m)	Limit (dBuV/m)	Margin (dB)	Remark
1	4920.000	44.44	1.45	45.89	74.00	-28.11	peak
2	8235.000	38.68	9.76	48.44	74.00	-25.56	peak
3	11880.000	35.33	15.46	50.79	74.00	-23.21	peak
4	13635.000	34.69	17.28	51.97	74.00	-22.03	peak
5	14745.000	33.69	17.84	51.53	74.00	-22.47	peak
6	17625.000	29.55	22.92	52.47	74.00	-21.53	peak

- Note: 1. Peak Result = Reading Level + Correct Factor.
 2. If Peak Result complies with AV limit, AV Result is deemed to comply with AV limit.
 3. Peak: Peak detector.
 4. Filter losses were only considered in the spurious frequency bands and the authorized band was not corrected for High Pass Filter losses.
 5. Proper operation of the transmitter prior to adding the filter to the measurement chain.

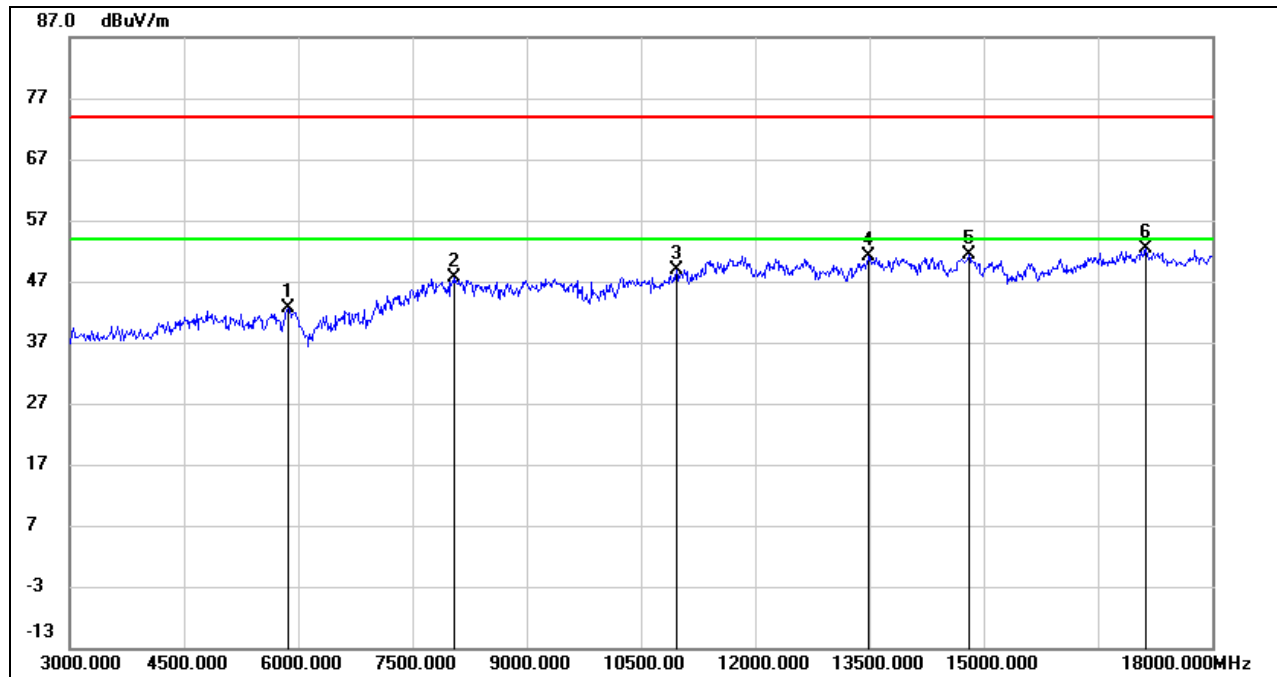
**8.3.2. 802.11g SISO MODE****HARMONICS AND SPURIOUS EMISSIONS (LOW CHANNEL, HORIZONTAL)**

No.	Frequency (MHz)	Reading (dBuV)	Correct (dB/m)	Result (dBuV/m)	Limit (dBuV/m)	Margin (dB)	Remark
1	5865.000	38.37	4.16	42.53	74.00	-31.47	peak
2	8055.000	38.23	9.48	47.71	74.00	-26.29	peak
3	10965.000	35.59	13.32	48.91	74.00	-25.09	peak
4	13485.000	33.95	17.19	51.14	74.00	-22.86	peak
5	14805.000	33.35	18.00	51.35	74.00	-22.65	peak
6	17130.000	30.45	21.92	52.37	74.00	-21.63	peak

Note: 1. Peak Result = Reading Level + Correct Factor.

2. If Peak Result complies with AV limit, AV Result is deemed to comply with AV limit.

3. Peak: Peak detector.

4. Filter losses were only considered in the spurious frequency bands and the authorized band was not corrected for High Pass Filter losses.

5. Proper operation of the transmitter prior to adding the filter to the measurement chain.



HARMONICS AND SPURIOUS EMISSIONS (LOW CHANNEL, VERTICAL)

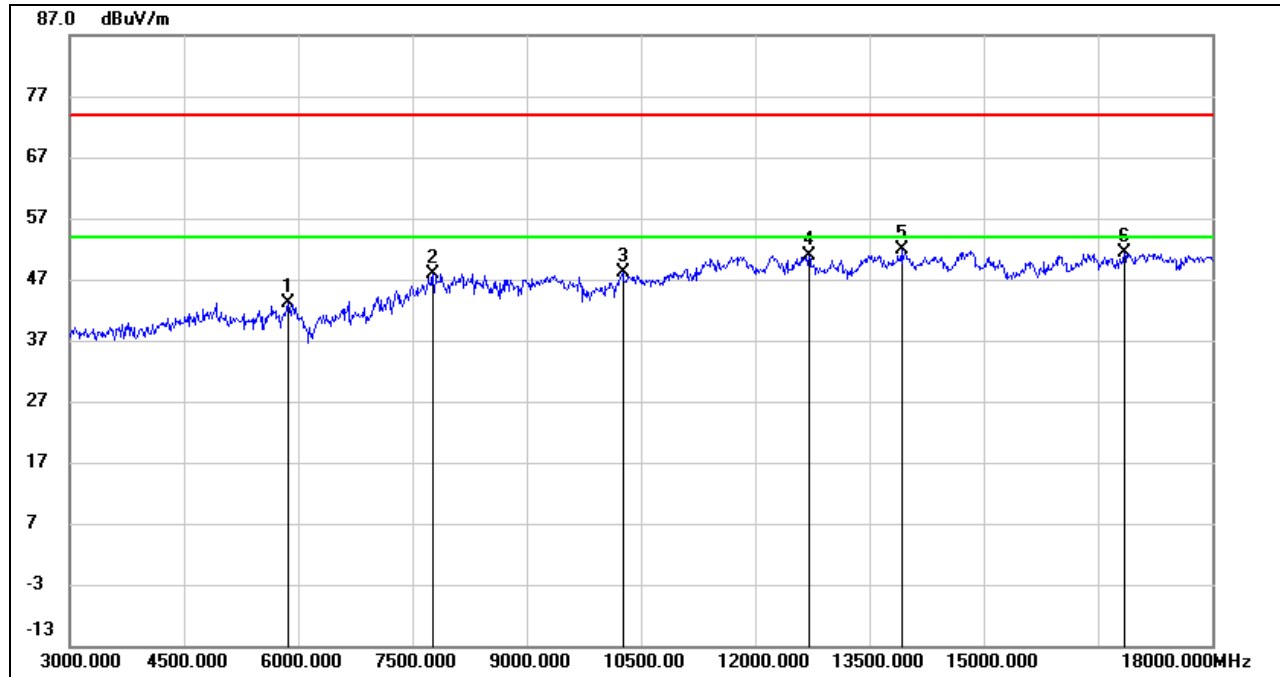

No.	Frequency (MHz)	Reading (dBuV)	Correct (dB/m)	Result (dBuV/m)	Limit (dBuV/m)	Margin (dB)	Remark
1	5865.000	39.03	4.16	43.19	74.00	-30.81	peak
2	7770.000	38.82	9.09	47.91	74.00	-26.09	peak
3	10260.000	36.55	11.68	48.23	74.00	-25.77	peak
4	12705.000	35.31	15.64	50.95	74.00	-23.05	peak
5	13920.000	34.24	17.55	51.79	74.00	-22.21	peak
6	16845.000	30.22	21.10	51.32	74.00	-22.68	peak

- Note: 1. Peak Result = Reading Level + Correct Factor.
 2. If Peak Result complies with AV limit, AV Result is deemed to comply with AV limit.
 3. Peak: Peak detector.
 4. Filter losses were only considered in the spurious frequency bands and the authorized band was not corrected for High Pass Filter losses.
 5. Proper operation of the transmitter prior to adding the filter to the measurement chain.



HARMONICS AND SPURIOUS EMISSIONS (MID CHANNEL, HORIZONTAL)

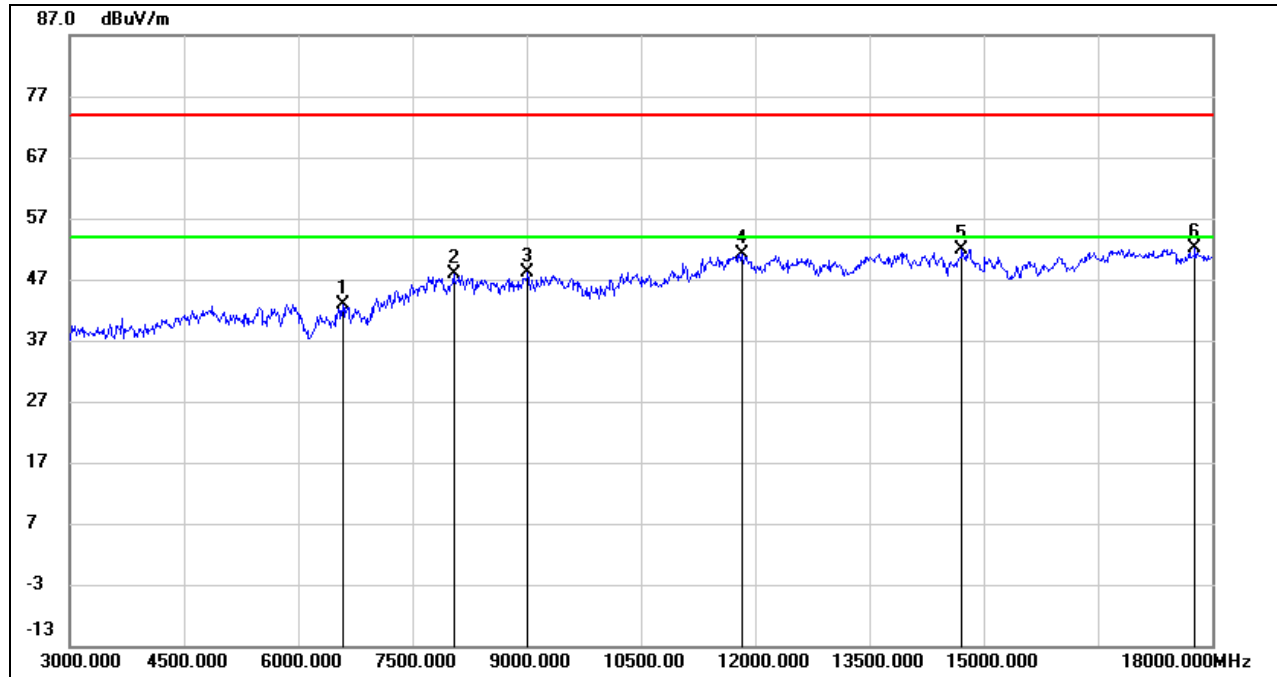

No.	Frequency (MHz)	Reading (dBuV)	Correct (dB/m)	Result (dBuV/m)	Limit (dBuV/m)	Margin (dB)	Remark
1	6585.000	36.79	6.06	42.85	74.00	-31.15	peak
2	8040.000	38.64	9.25	47.89	74.00	-26.11	peak
3	9015.000	37.03	11.10	48.13	74.00	-25.87	peak
4	11820.000	35.83	15.29	51.12	74.00	-22.88	peak
5	14715.000	34.25	17.74	51.99	74.00	-22.01	peak
6	17775.000	28.18	23.91	52.09	74.00	-21.91	peak

- Note: 1. Peak Result = Reading Level + Correct Factor.
 2. If Peak Result complies with AV limit, AV Result is deemed to comply with AV limit.
 3. Peak: Peak detector.
 4. Filter losses were only considered in the spurious frequency bands and the authorized band was not corrected for High Pass Filter losses.
 5. Proper operation of the transmitter prior to adding the filter to the measurement chain.

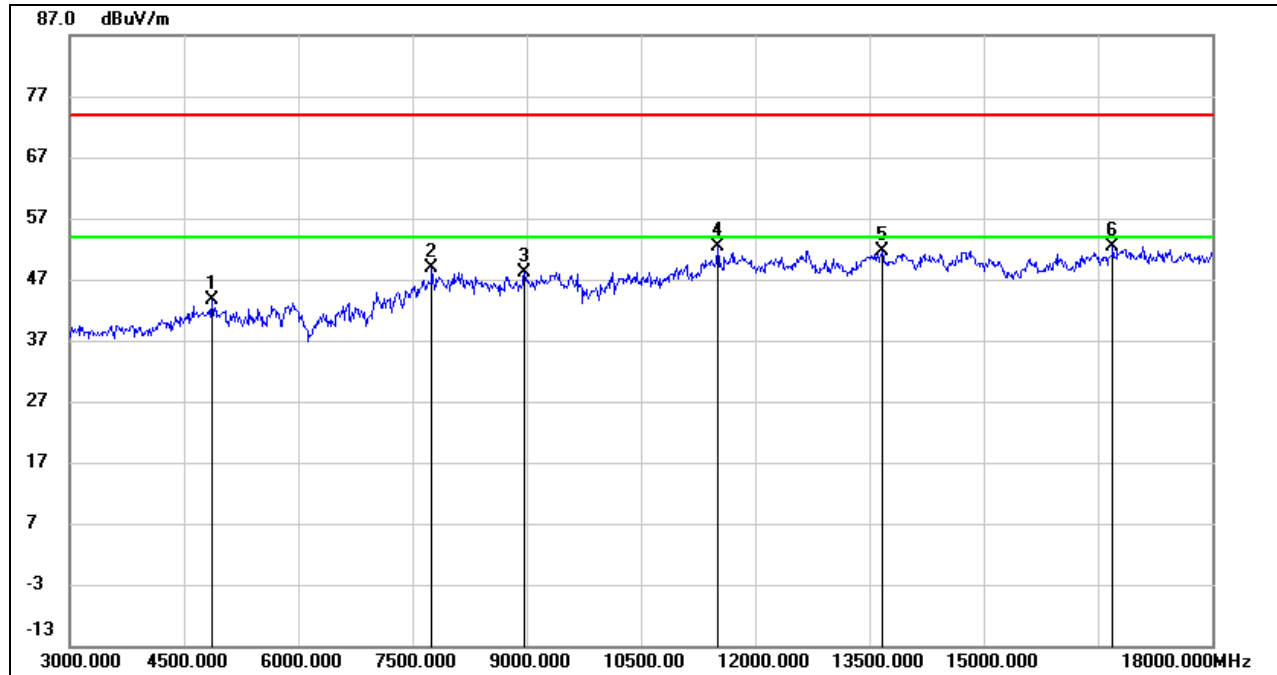
HARMONICS AND SPURIOUS EMISSIONS (MID CHANNEL, VERTICAL)

No.	Frequency (MHz)	Reading (dBuV)	Correct (dB/m)	Result (dBuV/m)	Limit (dBuV/m)	Margin (dB)	Remark
1	4860.000	42.21	1.33	43.54	74.00	-30.46	peak
2	7755.000	39.83	8.94	48.77	74.00	-25.23	peak
3	8970.000	37.54	10.70	48.24	74.00	-25.76	peak
4	11505.000	37.75	14.66	52.41	74.00	-21.59	peak
5	13665.000	34.14	17.43	51.57	74.00	-22.43	peak
6	16695.000	32.50	19.95	52.45	74.00	-21.55	peak

Note: 1. Peak Result = Reading Level + Correct Factor.

2. If Peak Result complies with AV limit, AV Result is deemed to comply with AV limit.

3. Peak: Peak detector.

4. Filter losses were only considered in the spurious frequency bands and the authorized band was not corrected for High Pass Filter losses.

5. Proper operation of the transmitter prior to adding the filter to the measurement chain.

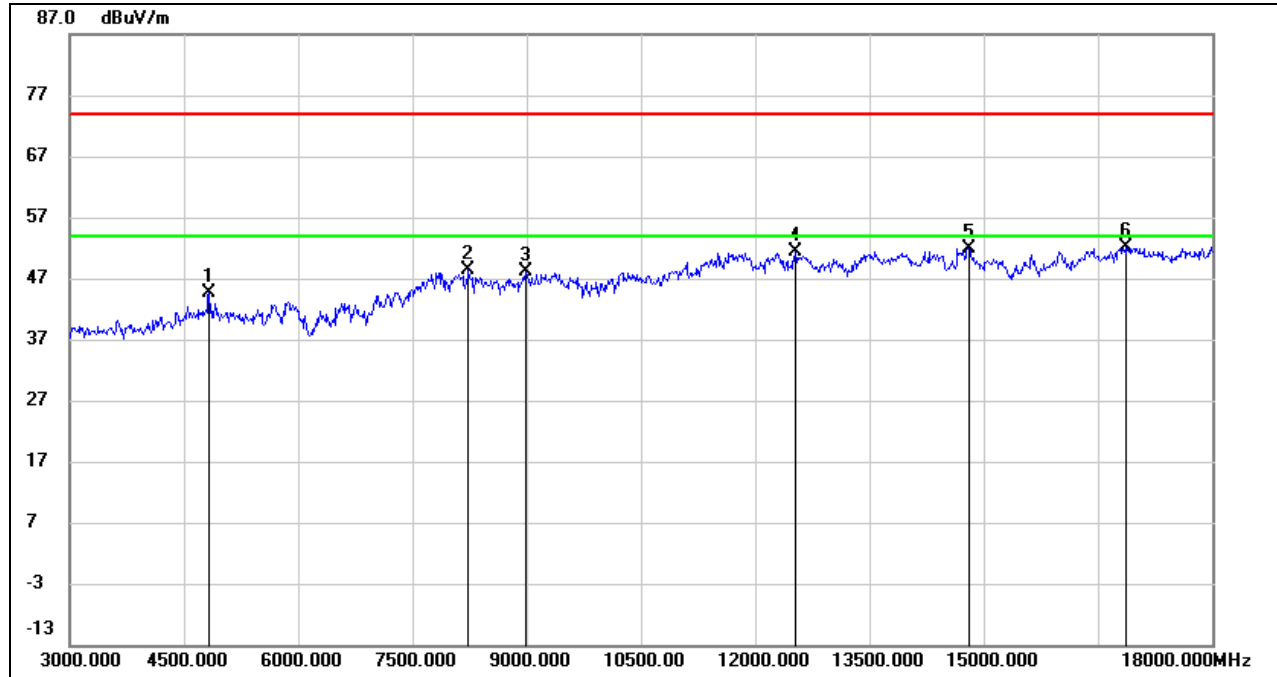
**HARMONICS AND SPURIOUS EMISSIONS (HIGH CHANNEL, HORIZONTAL)**

No.	Frequency (MHz)	Reading (dBuV)	Correct (dB/m)	Result (dBuV/m)	Limit (dBuV/m)	Margin (dB)	Remark
1	4830.000	43.20	1.37	44.57	74.00	-29.43	peak
2	8235.000	38.71	9.76	48.47	74.00	-25.53	peak
3	8985.000	37.09	10.99	48.08	74.00	-25.92	peak
4	12525.000	35.57	15.70	51.27	74.00	-22.73	peak
5	14805.000	34.00	18.00	52.00	74.00	-22.00	peak
6	16860.000	30.89	21.22	52.11	74.00	-21.89	peak

Note: 1. Peak Result = Reading Level + Correct Factor.

2. If Peak Result complies with AV limit, AV Result is deemed to comply with AV limit.

3. Peak: Peak detector.

4. Filter losses were only considered in the spurious frequency bands and the authorized band was not corrected for High Pass Filter losses.

5. Proper operation of the transmitter prior to adding the filter to the measurement chain.

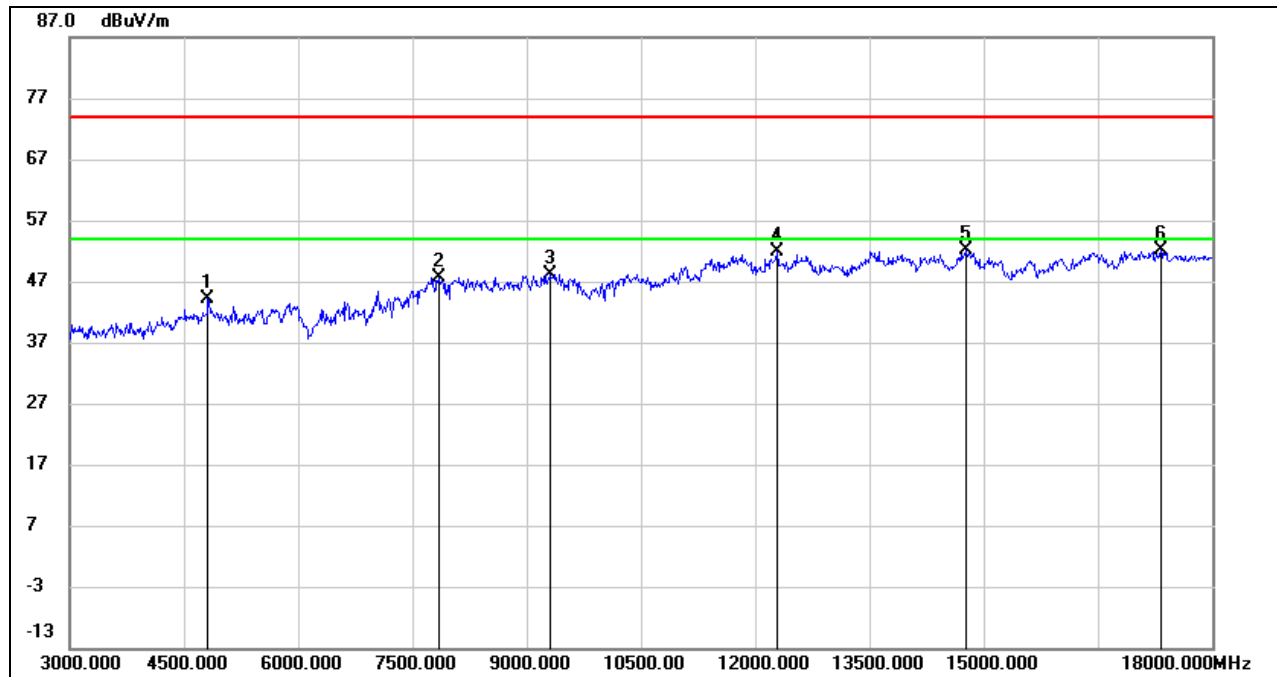
**HARMONICS AND SPURIOUS EMISSIONS (HIGH CHANNEL, VERTICAL)**

No.	Frequency (MHz)	Reading (dBuV)	Correct (dB/m)	Result (dBuV/m)	Limit (dBuV/m)	Margin (dB)	Remark
1	4815.000	42.66	1.38	44.04	74.00	-29.96	peak
2	7845.000	38.48	9.14	47.62	74.00	-26.38	peak
3	9315.000	37.75	10.48	48.23	74.00	-25.77	peak
4	12285.000	35.78	16.08	51.86	74.00	-22.14	peak
5	14775.000	34.26	17.95	52.21	74.00	-21.79	peak
6	17325.000	29.64	22.42	52.06	74.00	-21.94	peak

Note: 1. Peak Result = Reading Level + Correct Factor.

2. If Peak Result complies with AV limit, AV Result is deemed to comply with AV limit.

3. Peak: Peak detector.

4. Filter losses were only considered in the spurious frequency bands and the authorized band was not corrected for High Pass Filter losses.

5. Proper operation of the transmitter prior to adding the filter to the measurement chain.

8.3.3. 802.11n HT20 MIMO MODE

HARMONICS AND SPURIOUS EMISSIONS (LOW CHANNEL, HORIZONTAL)

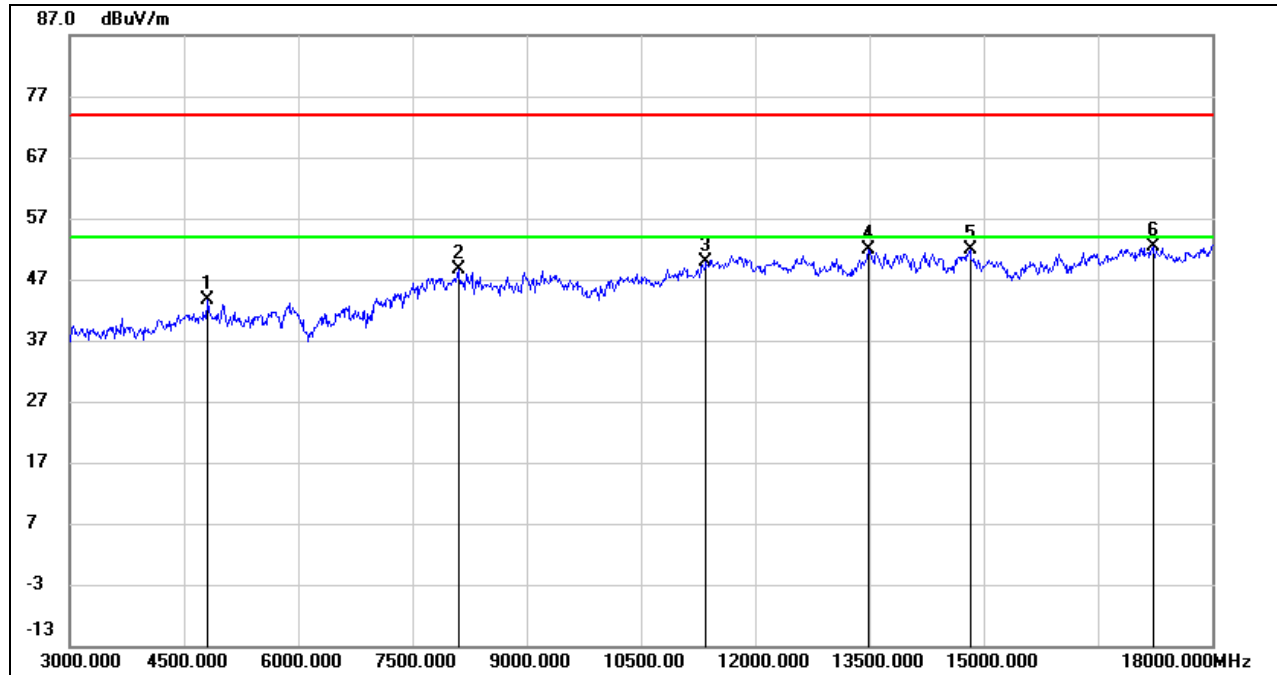

No.	Frequency (MHz)	Reading (dBuV)	Correct (dB/m)	Result (dBuV/m)	Limit (dBuV/m)	Margin (dB)	Remark
1	4815.000	42.32	1.38	43.70	74.00	-30.30	peak
2	8100.000	38.42	10.18	48.60	74.00	-25.40	peak
3	11355.000	35.62	14.34	49.96	74.00	-24.04	peak
4	13485.000	34.58	17.19	51.77	74.00	-22.23	peak
5	14820.000	33.89	17.91	51.80	74.00	-22.20	peak
6	17220.000	30.29	22.12	52.41	74.00	-21.59	peak

Note: 1. Peak Result = Reading Level + Correct Factor.

2. If Peak Result complies with AV limit, AV Result is deemed to comply with AV limit.

3. Peak: Peak detector.

4. Filter losses were only considered in the spurious frequency bands and the authorized band was not corrected for High Pass Filter losses.

5. Proper operation of the transmitter prior to adding the filter to the measurement chain.

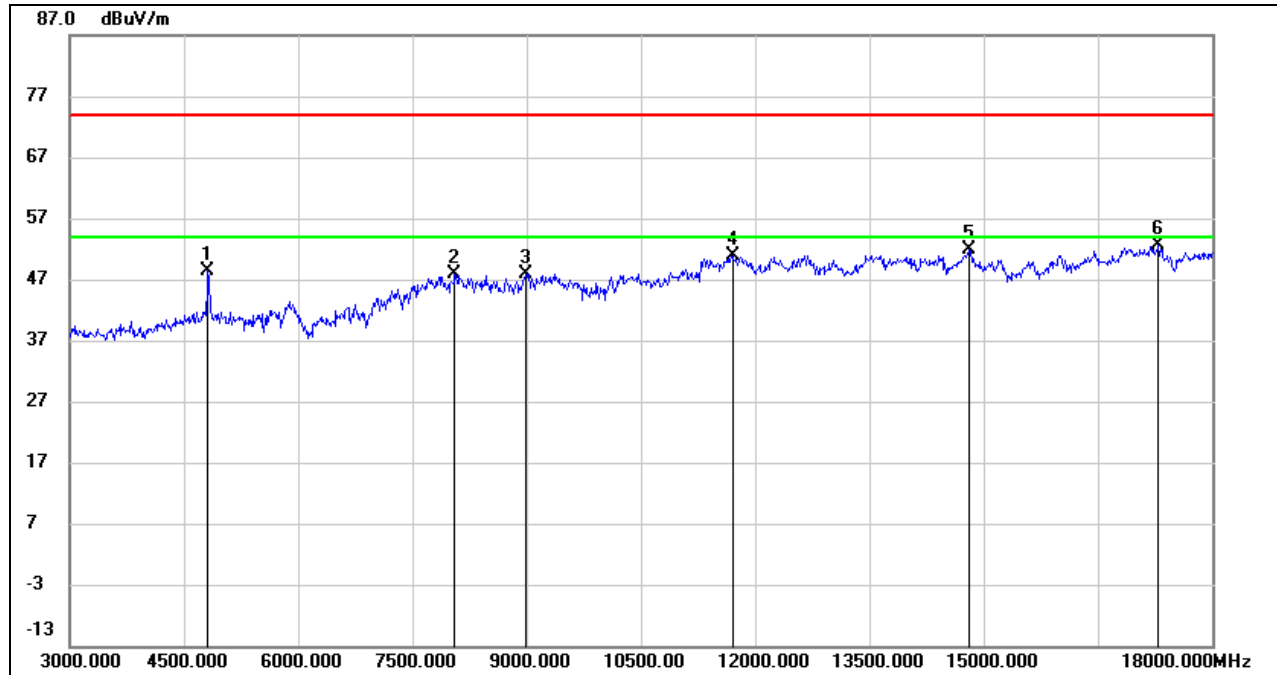
**HARMONICS AND SPURIOUS EMISSIONS (LOW CHANNEL, VERTICAL)**

No.	Frequency (MHz)	Reading (dBuV)	Correct (dB/m)	Result (dBuV/m)	Limit (dBuV/m)	Margin (dB)	Remark
1	4815.000	46.92	1.38	48.30	74.00	-25.70	peak
2	8055.000	38.48	9.48	47.96	74.00	-26.04	peak
3	8985.000	36.96	10.99	47.95	74.00	-26.05	peak
4	11700.000	35.57	15.35	50.92	74.00	-23.08	peak
5	14805.000	33.77	18.00	51.77	74.00	-22.23	peak
6	17295.000	30.06	22.58	52.64	74.00	-21.36	peak

Note: 1. Peak Result = Reading Level + Correct Factor.

2. If Peak Result complies with AV limit, AV Result is deemed to comply with AV limit.

3. Peak: Peak detector.

4. Filter losses were only considered in the spurious frequency bands and the authorized band was not corrected for High Pass Filter losses.

5. Proper operation of the transmitter prior to adding the filter to the measurement chain.



HARMONICS AND SPURIOUS EMISSIONS (MID CHANNEL, HORIZONTAL)

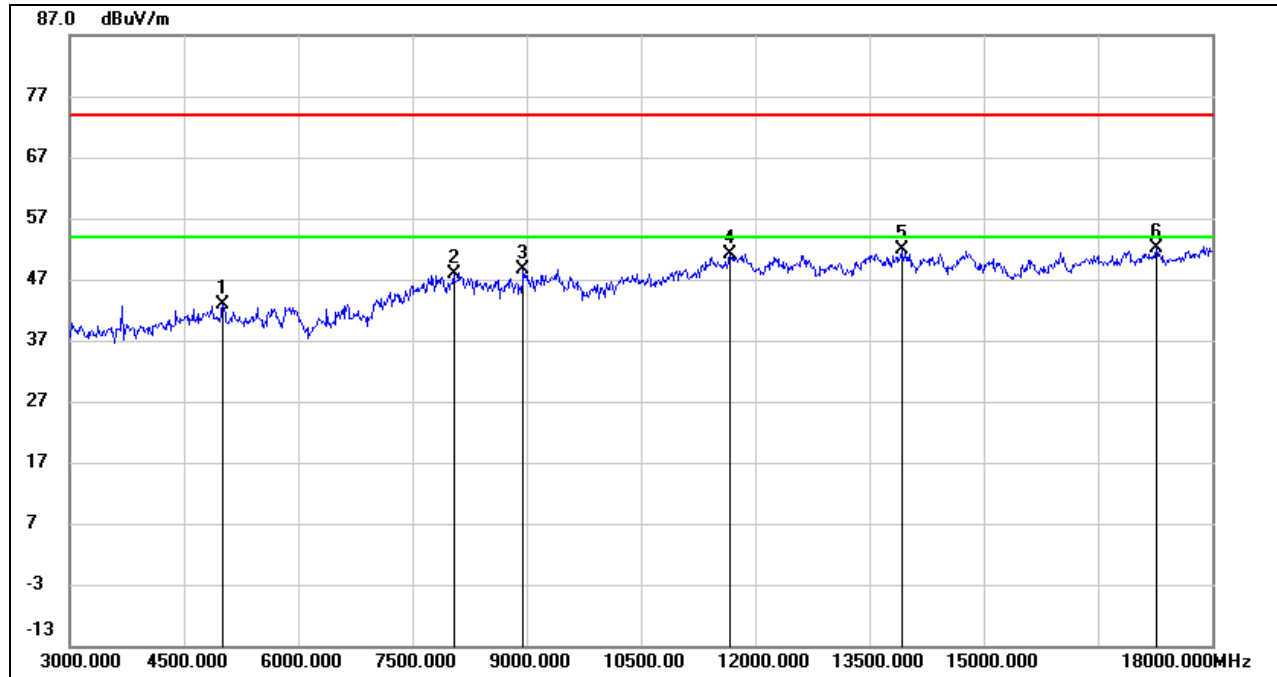

No.	Frequency (MHz)	Reading (dBuV)	Correct (dB/m)	Result (dBuV/m)	Limit (dBuV/m)	Margin (dB)	Remark
1	5010.000	40.70	2.11	42.81	74.00	-31.19	peak
2	8040.000	38.60	9.25	47.85	74.00	-26.15	peak
3	8955.000	38.26	10.41	48.67	74.00	-25.33	peak
4	11670.000	35.92	15.16	51.08	74.00	-22.92	peak
5	13920.000	34.41	17.55	51.96	74.00	-22.04	peak
6	17265.000	29.76	22.39	52.15	74.00	-21.85	peak

- Note: 1. Peak Result = Reading Level + Correct Factor.
 2. If Peak Result complies with AV limit, AV Result is deemed to comply with AV limit.
 3. Peak: Peak detector.
 4. Filter losses were only considered in the spurious frequency bands and the authorized band was not corrected for High Pass Filter losses.
 5. Proper operation of the transmitter prior to adding the filter to the measurement chain.

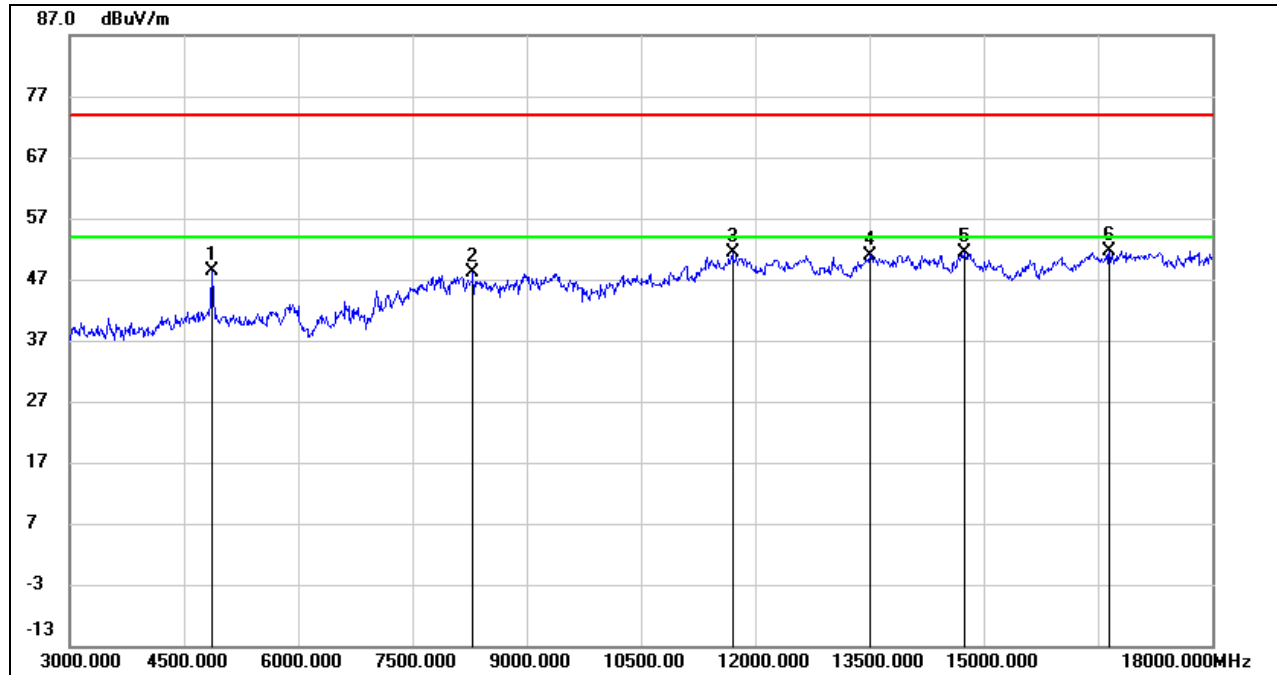
**HARMONICS AND SPURIOUS EMISSIONS (MID CHANNEL, VERTICAL)**

No.	Frequency (MHz)	Reading (dBuV)	Correct (dB/m)	Result (dBuV/m)	Limit (dBuV/m)	Margin (dB)	Remark
1	4860.000	46.93	1.33	48.26	74.00	-25.74	peak
2	8295.000	38.52	9.69	48.21	74.00	-25.79	peak
3	11700.000	35.92	15.35	51.27	74.00	-22.73	peak
4	13500.000	33.78	17.22	51.00	74.00	-23.00	peak
5	14745.000	33.62	17.84	51.46	74.00	-22.54	peak
6	16650.000	31.67	19.98	51.65	74.00	-22.35	peak

Note: 1. Peak Result = Reading Level + Correct Factor.

2. If Peak Result complies with AV limit, AV Result is deemed to comply with AV limit.

3. Peak: Peak detector.

4. Filter losses were only considered in the spurious frequency bands and the authorized band was not corrected for High Pass Filter losses.

5. Proper operation of the transmitter prior to adding the filter to the measurement chain.

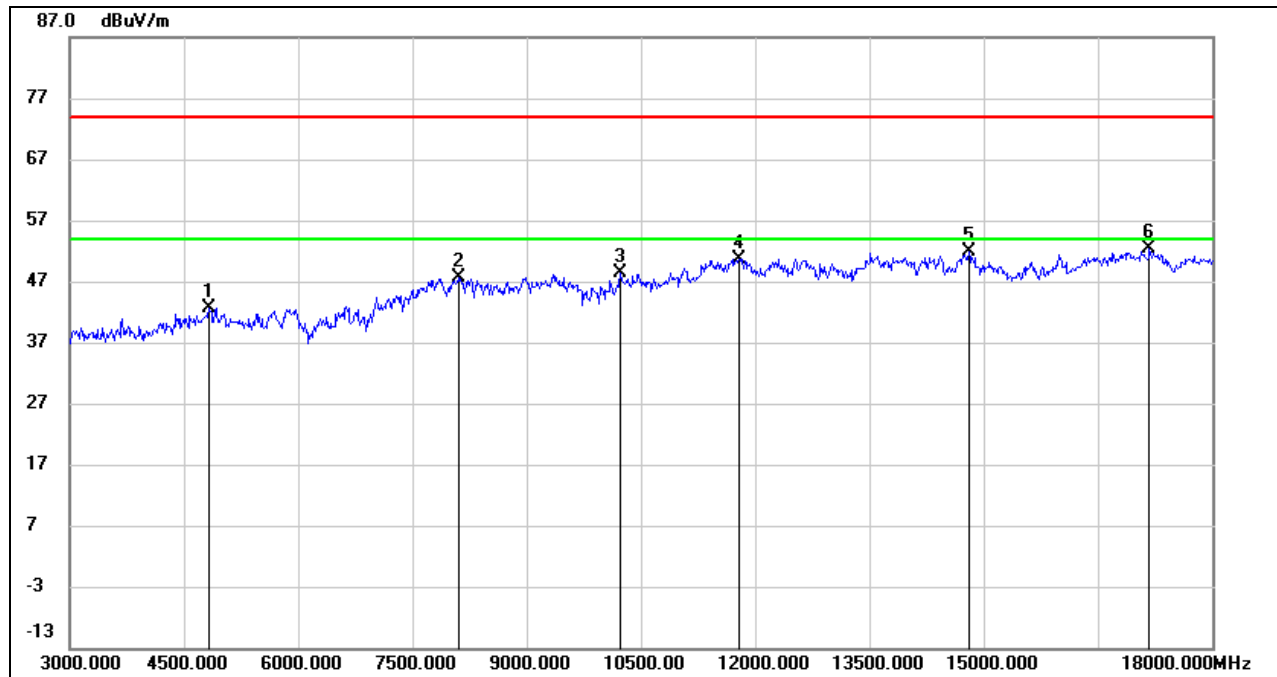
**HARMONICS AND SPURIOUS EMISSIONS (HIGH CHANNEL, HORIZONTAL)**

No.	Frequency (MHz)	Reading (dBuV)	Correct (dB/m)	Result (dBuV/m)	Limit (dBuV/m)	Margin (dB)	Remark
1	4830.000	41.25	1.37	42.62	74.00	-31.38	peak
2	8100.000	37.40	10.18	47.58	74.00	-26.42	peak
3	10230.000	36.72	11.58	48.30	74.00	-25.70	peak
4	11790.000	35.48	15.26	50.74	74.00	-23.26	peak
5	14805.000	33.90	18.00	51.90	74.00	-22.10	peak
6	17175.000	30.40	21.97	52.37	74.00	-21.63	peak

Note: 1. Peak Result = Reading Level + Correct Factor.

2. If Peak Result complies with AV limit, AV Result is deemed to comply with AV limit.

3. Peak: Peak detector.

4. Filter losses were only considered in the spurious frequency bands and the authorized band was not corrected for High Pass Filter losses.

5. Proper operation of the transmitter prior to adding the filter to the measurement chain.

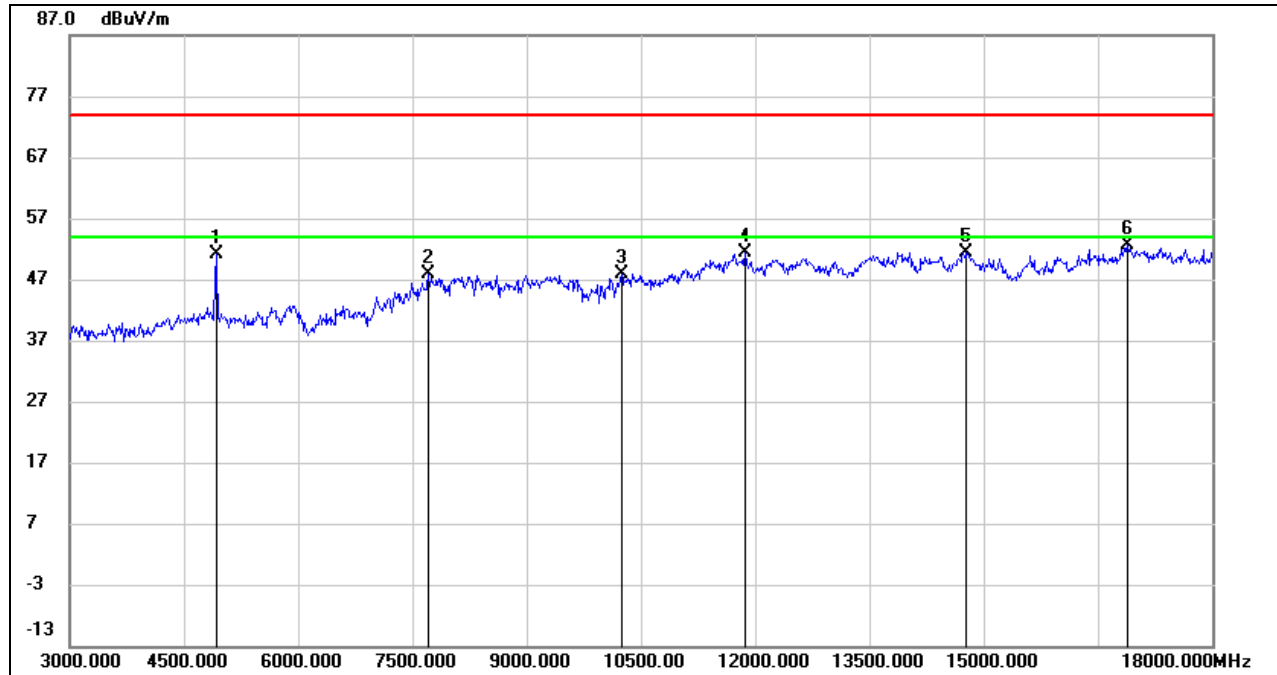
**HARMONICS AND SPURIOUS EMISSIONS (HIGH CHANNEL, VERTICAL)**

No.	Frequency (MHz)	Reading (dBuV)	Correct (dB/m)	Result (dBuV/m)	Limit (dBuV/m)	Margin (dB)	Remark
1	4920.000	49.59	1.45	51.04	74.00	-22.96	peak
2	7710.000	39.39	8.54	47.93	74.00	-26.07	peak
3	10245.000	36.36	11.63	47.99	74.00	-26.01	peak
4	11865.000	35.91	15.42	51.33	74.00	-22.67	peak
5	14775.000	33.54	17.95	51.49	74.00	-22.51	peak
6	16890.000	31.04	21.49	52.53	74.00	-21.47	peak

Note: 1. Peak Result = Reading Level + Correct Factor.

2. If Peak Result complies with AV limit, AV Result is deemed to comply with AV limit.

3. Peak: Peak detector.

4. Filter losses were only considered in the spurious frequency bands and the authorized band was not corrected for High Pass Filter losses.

5. Proper operation of the transmitter prior to adding the filter to the measurement chain.

8.4. SPURIOUS EMISSIONS (18 GHz ~ 26 GHz)

8.4.1. 802.11n HT20 MIMO MODE

SPURIOUS EMISSIONS (LOW CHANNEL, WORST-CASE CONFIGURATION, HORIZONTAL)

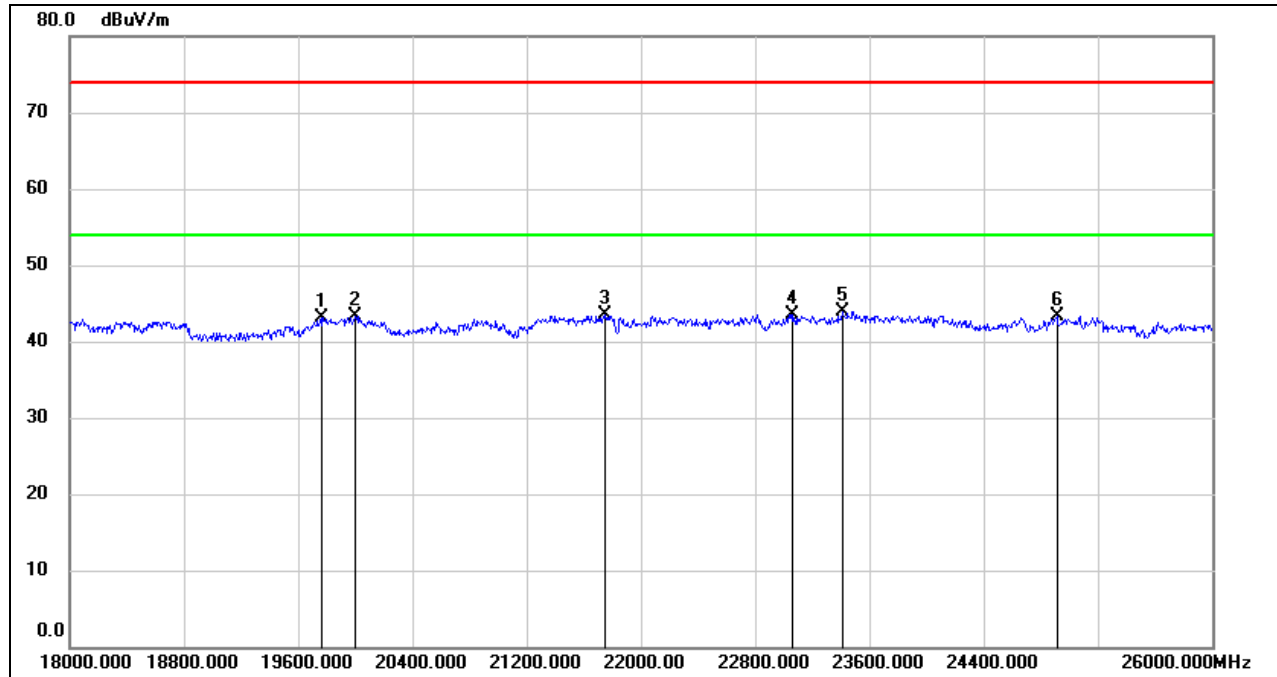

No.	Frequency (MHz)	Reading (dBuV)	Correct (dB/m)	Result (dBuV/m)	Limit (dBuV/m)	Margin (dB)	Remark
1	19760.000	48.36	-5.26	43.10	74.00	-30.90	peak
2	20000.000	48.81	-5.45	43.36	74.00	-30.64	peak
3	21752.000	47.80	-4.32	43.48	74.00	-30.52	peak
4	23064.000	46.99	-3.42	43.57	74.00	-30.43	peak
5	23408.000	47.11	-3.22	43.89	74.00	-30.11	peak
6	24912.000	45.42	-2.18	43.24	74.00	-30.76	peak

Note: 1. Measurement = Reading Level + Correct Factor.

2. If Peak Result complies with AV limit, AV Result is deemed to comply with AV limit.

3. Peak: Peak detector.

4. The preamplifier only effect to the above 18GHz signal and no filter added to the measurement chain.

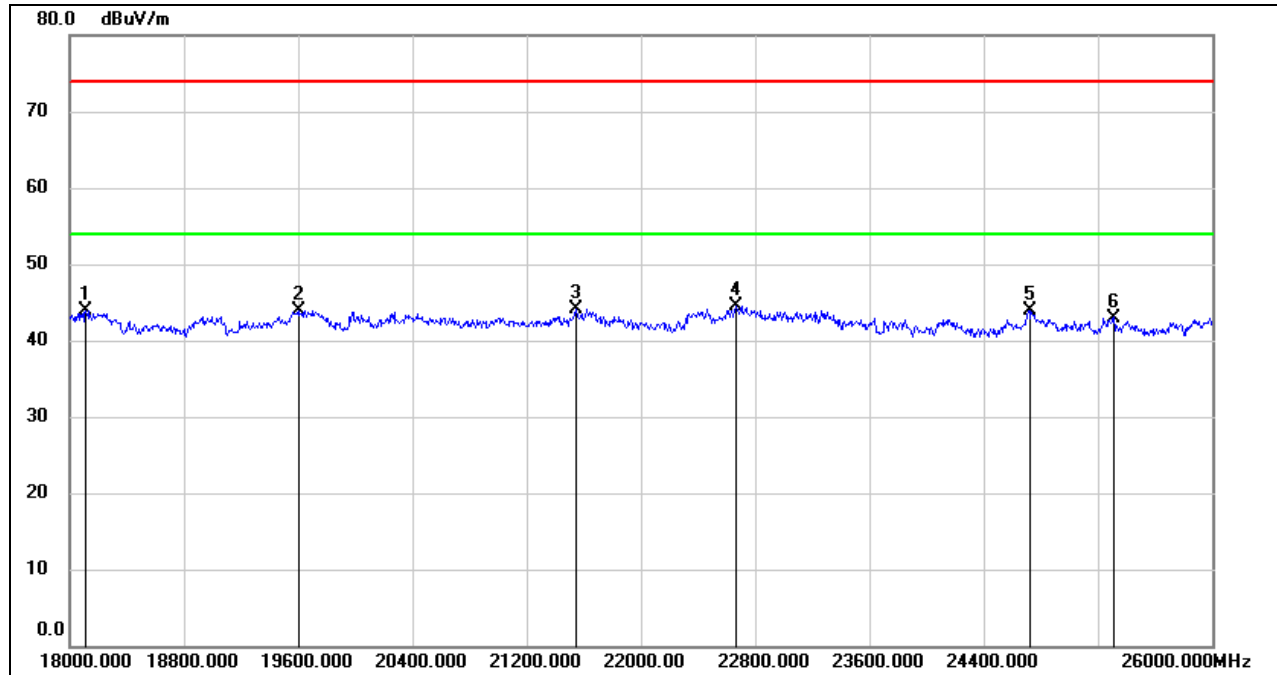
**SPURIOUS EMISSIONS (LOW CHANNEL, WORST-CASE CONFIGURATION, VERTICAL)**

No.	Frequency (MHz)	Reading (dBuV)	Correct (dB/m)	Result (dBuV/m)	Limit (dBuV/m)	Margin (dB)	Remark
1	18112.000	49.46	-5.47	43.99	74.00	-30.01	peak
2	19600.000	49.29	-5.43	43.86	74.00	-30.14	peak
3	21544.000	48.76	-4.63	44.13	74.00	-29.87	peak
4	22664.000	48.21	-3.76	44.45	74.00	-29.55	peak
5	24720.000	46.22	-2.33	43.89	74.00	-30.11	peak
6	25312.000	44.70	-1.70	43.00	74.00	-31.00	peak

Note: 1. Measurement = Reading Level + Correct Factor.

2. If Peak Result complies with AV limit, AV Result is deemed to comply with AV limit.

3. Peak: Peak detector.

4. The preamplifier only effect to the above 18GHz signal and no filter added to the measurement chain.

Note: All the modes and channels had been tested, but only the worst data was recorded in the report.



8.5. SPURIOUS EMISSIONS (30 MHz ~ 1 GHz)

8.5.1. 802.11n HT20 MIMO MODE

SPURIOUS EMISSIONS (HIGH CHANNEL, WORST-CASE CONFIGURATION, HORIZONTAL)

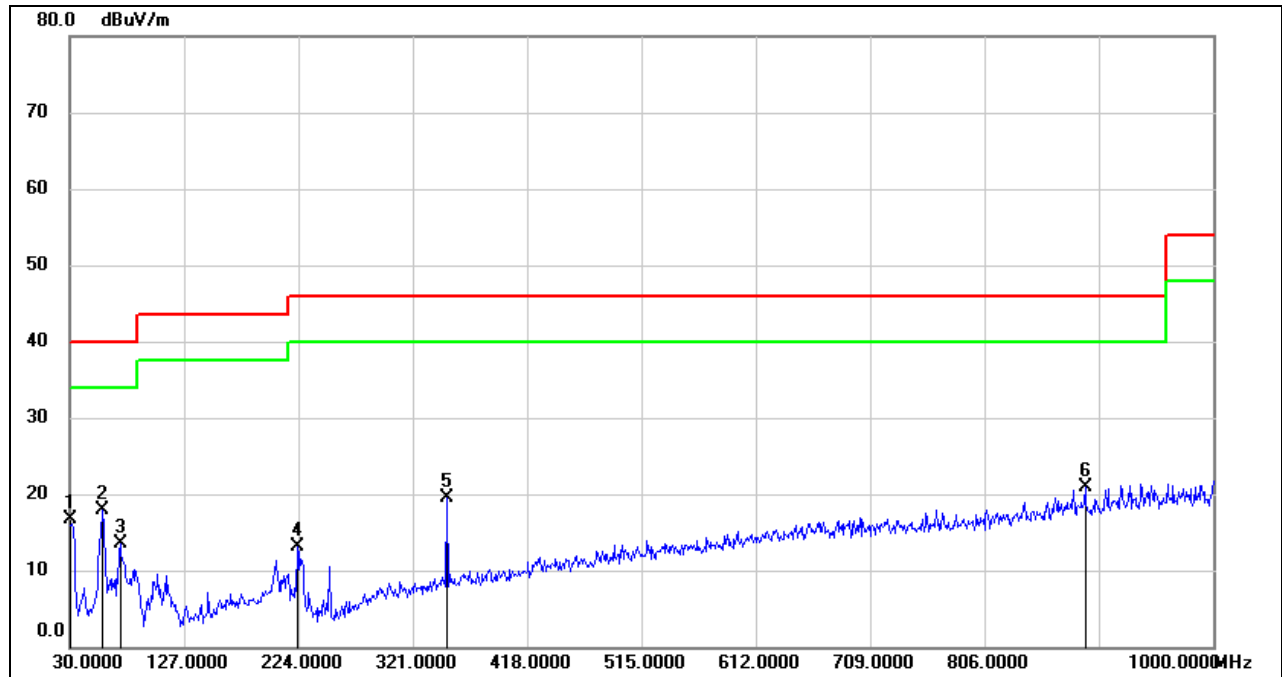

No.	Frequency (MHz)	Reading (dBuV)	Correct (dB/m)	Result (dBuV/m)	Limit (dBuV/m)	Margin (dB)	Remark
1	30.0000	35.68	-18.94	16.74	40.00	-23.26	QP
2	58.1300	38.47	-20.55	17.92	40.00	-22.08	QP
3	72.6800	34.19	-20.76	13.43	40.00	-26.57	QP
4	223.0300	31.51	-18.32	13.19	46.00	-32.81	QP
5	350.1000	33.82	-14.32	19.50	46.00	-26.50	QP
6	891.3600	26.12	-5.24	20.88	46.00	-25.12	QP

- Note: 1. Result Level = Read Level + Correct Factor.
 2. If Peak Result complies with QP limit, QP Result is deemed to comply with QP limit.
 3. Test setup: RBW: 120 kHz, VBW: 300 kHz, Sweep time: auto.

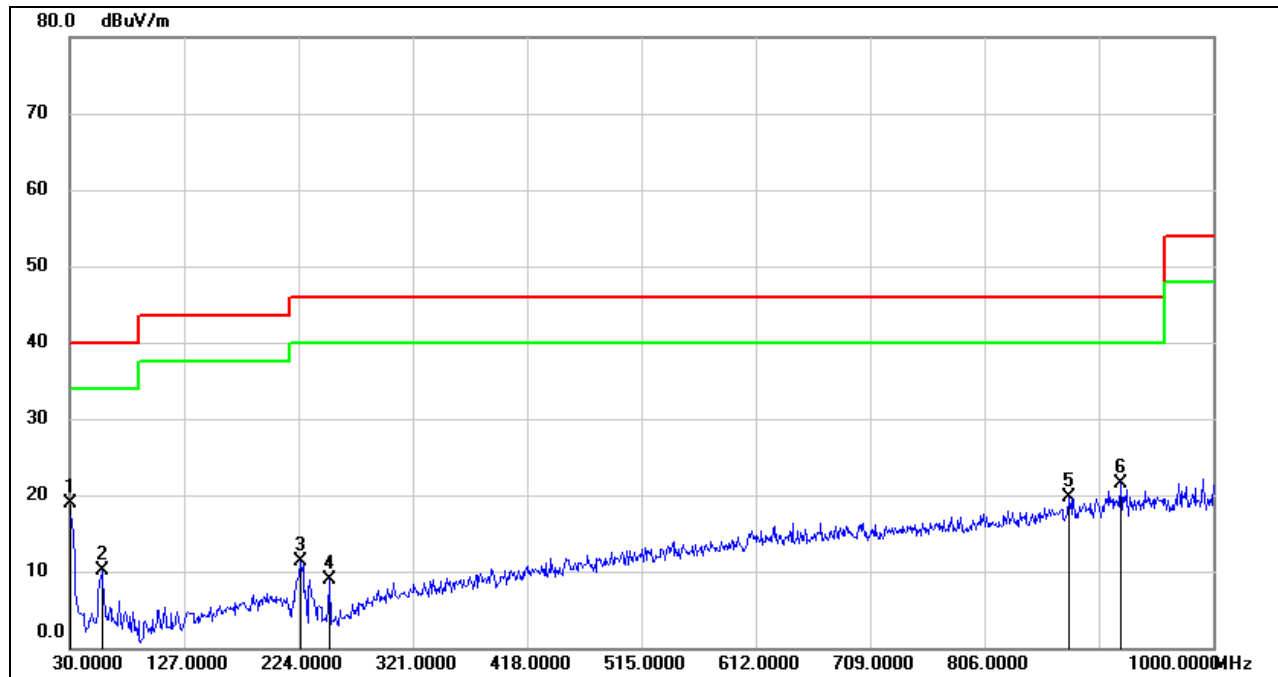
**SPURIOUS EMISSIONS (HIGH CHANNEL, WORST-CASE CONFIGURATION, VERTICAL)**

No.	Frequency (MHz)	Reading (dBuV)	Correct (dB/m)	Result (dBuV/m)	Limit (dBuV/m)	Margin (dB)	Remark
1	30.0000	37.90	-18.94	18.96	40.00	-21.04	QP
2	57.1600	30.66	-20.58	10.08	40.00	-29.92	QP
3	225.9400	29.74	-18.47	11.27	46.00	-34.73	QP
4	250.1900	27.84	-18.91	8.93	46.00	-37.07	QP
5	877.7800	25.22	-5.58	19.64	46.00	-26.36	QP
6	921.4300	26.26	-4.76	21.50	46.00	-24.50	QP

Note: 1. Result Level = Read Level + Correct Factor.

2. If Peak Result complies with QP limit, QP Result is deemed to comply with QP limit.

3. Test setup: RBW: 120 kHz, VBW: 300 kHz, Sweep time: auto

Note: All the modes and channels had been tested, but only the worst data was recorded in the report.

8.6. SPURIOUS EMISSIONS BELOW 30 MHz

8.6.1. 802.11n HT20 MIMO MODE

SPURIOUS EMISSIONS (HIGH CHANNEL, LOOP ANTENNA FACE ON TO THE EUT, WORST-CASE CONFIGURATION)

9 kHz~ 150 kHz

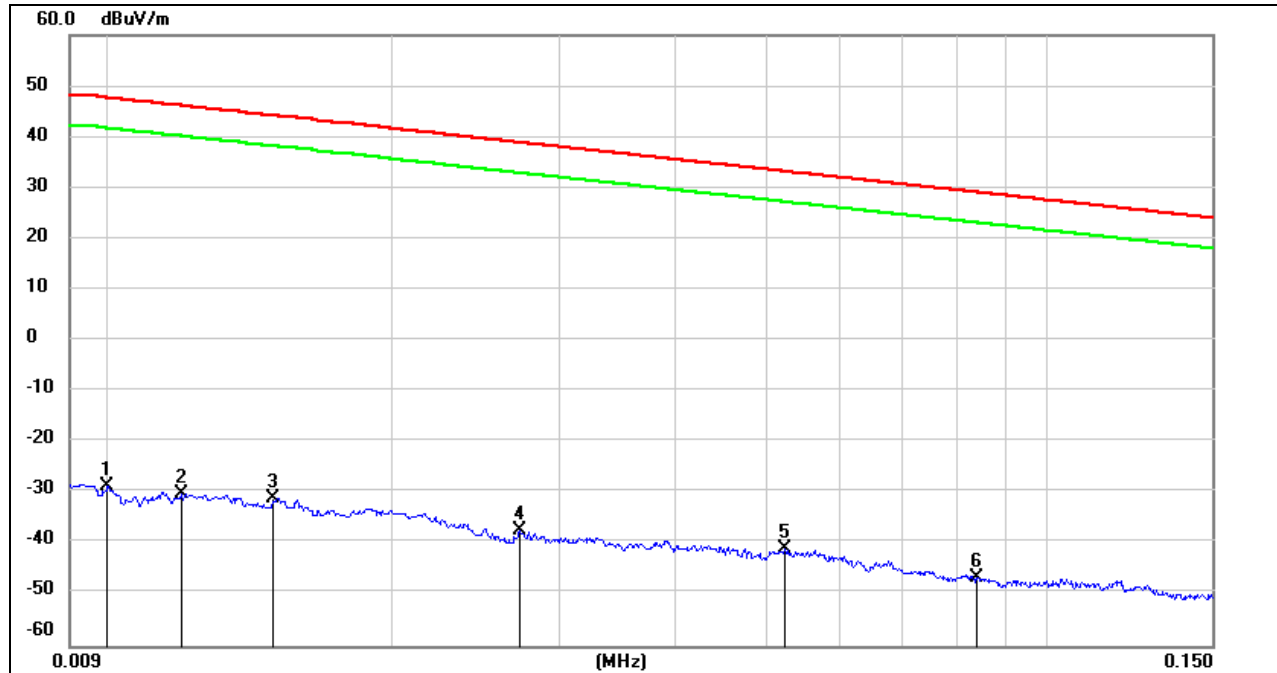

No.	Frequency (MHz)	Reading (dBuV)	Correct (dB/m)	FCC Result (dBuV/m)	FCC Limit (dBuV/m)	ISED Result (dBuA/m)	ISED Limit (dBuA/m)	Margin (dB)	Remark
1	0.0100	72.72	-101.40	-28.68	47.6	-80.18	-3.90	-76.28	peak
2	0.0119	71.16	-101.39	-30.23	46.09	-81.73	-5.41	-76.32	peak
3	0.0149	70.37	-101.37	-31	44.14	-82.50	-7.36	-75.14	peak
4	0.0273	63.99	-101.38	-37.39	38.88	-88.89	-12.62	-76.27	peak
5	0.0524	60.67	-101.49	-40.82	33.21	-92.32	-18.29	-74.03	peak
6	0.0840	55.01	-101.67	-46.66	29.12	-98.16	-22.38	-75.78	peak

Note: 1. Measurement = Reading Level + Correct Factor (dBuV/m- 20Log10[120π] = dBuV/m-51.5).

2. If Peak Result complies with AV and QP limit, AV and QP Result are deemed to comply with AV limit.

3. All 3 polarizations (Horizontal, Face-on and Face-off) of the loop antenna had been tested, but only the worst data recorded in the report.

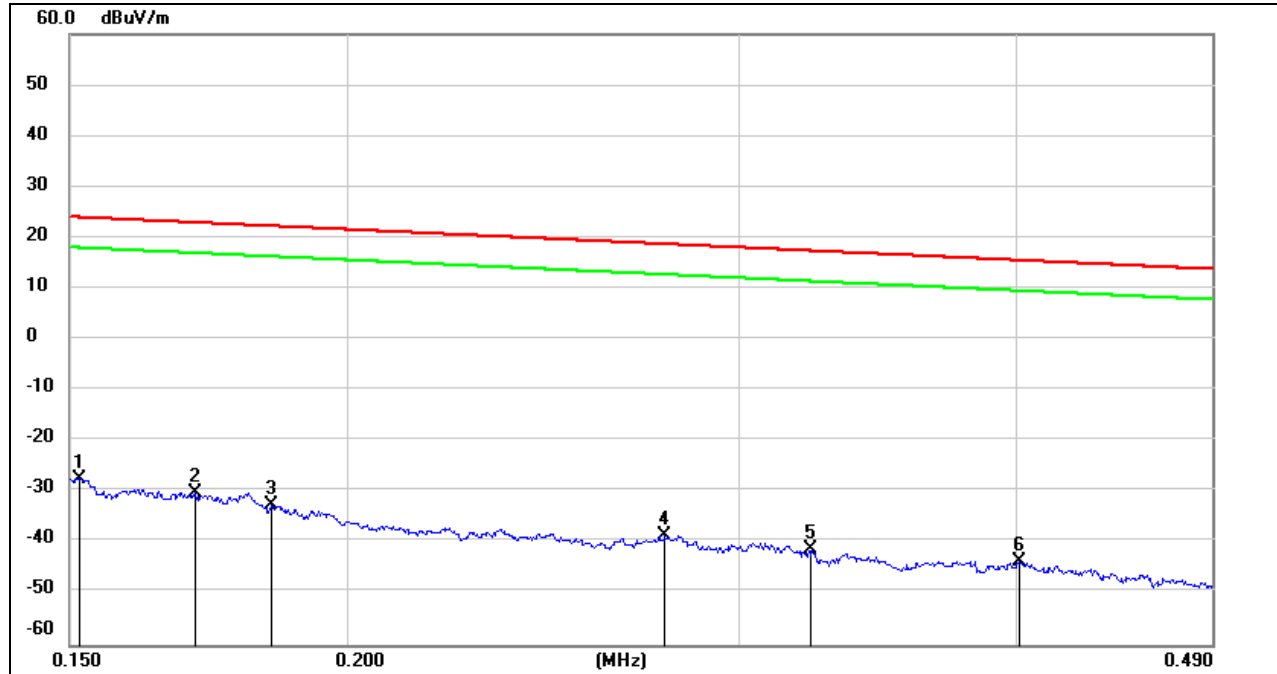
150 kHz ~ 490 kHz

No.	Frequency (MHz)	Reading (dBuV)	Correct (dB/m)	FCC Result (dBuV/m)	FCC Limit (dBuV/m)	ISED Result (dBuA/m)	ISED Limit (dBuA/m)	Margin (dB)	Remark
1	0.1517	74.25	-101.63	-27.38	23.98	-78.88	-27.52	-51.36	peak
2	0.1708	71.43	-101.67	-30.24	22.96	-81.74	-28.54	-53.20	peak
3	0.1849	69.04	-101.70	-32.66	22.27	-84.16	-29.23	-54.93	peak
4	0.2782	63.29	-101.83	-38.54	18.71	-90.04	-32.79	-57.25	peak
5	0.3234	60.48	-101.88	-41.4	17.41	-92.90	-34.09	-58.81	peak
6	0.4012	58.31	-101.96	-43.65	15.53	-95.15	-35.97	-59.18	peak

Note: 1. Measurement = Reading Level + Correct Factor (dBuV/m- 20Log10[120π] = dBuV/m- 51.5).

2. If Peak Result complies with AV and QP limit, AV and QP Result are deemed to comply with AV limit.

3. All 3 polarizations (Horizontal, Face-on and Face-off) of the loop antenna had been tested, but only the worst data recorded in the report.

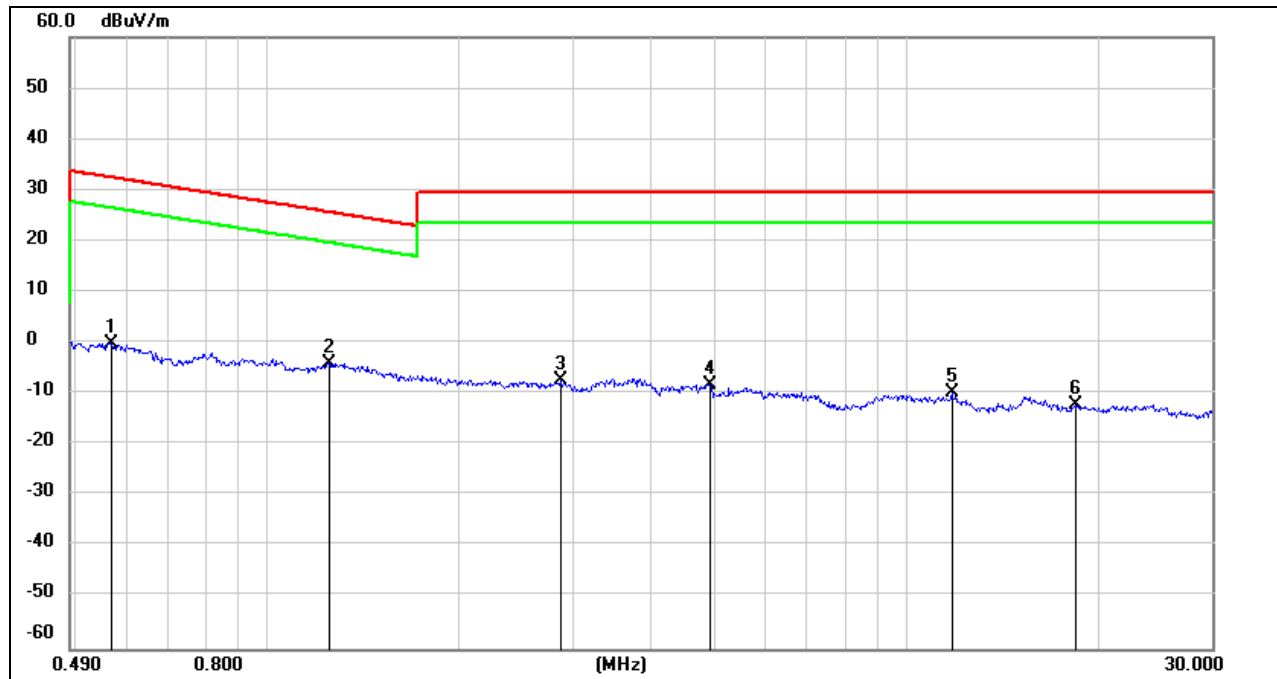
490 kHz ~ 30 MHz

No.	Frequency (MHz)	Reading (dBuV)	Correct (dB/m)	FCC Result (dBuV/m)	FCC Limit (dBuV/m)	ISED Result (dBuA/m)	ISED Limit (dBuA/m)	Margin (dB)	Remark
1	0.5705	61.87	-62.07	-0.2	32.48	-51.70	-19.02	-32.68	peak
2	1.2459	58.25	-62.16	-3.91	25.7	-55.41	-25.80	-29.61	peak
3	2.8803	54.34	-61.60	-7.26	29.54	-58.76	-21.96	-36.80	peak
4	4.9165	53.38	-61.48	-8.1	29.54	-59.60	-21.96	-37.64	peak
5	11.7628	51.03	-60.88	-9.85	29.54	-61.35	-21.96	-39.39	peak
6	18.3429	48.86	-60.90	-12.04	29.54	-63.54	-21.96	-41.58	peak

Note: 1. Measurement = Reading Level + Correct Factor (dBuV/m- 20Log10[120π] = dBuV/m- 51.5).

2. If Peak Result complies with AV and QP limit, AV and QP Result are deemed to comply with AV limit.

3. All 3 polarizations (Horizontal, Face-on and Face-off) of the loop antenna had been tested, but only the worst data recorded in the report.

Note: All the modes and channels had been tested, but only the worst data was recorded in the report.

9. AC POWER LINE CONDUCTED EMISSIONS

LIMITS

Please refer to CFR 47 FCC §15.207 (a)

FREQUENCY (MHz)	Quasi-peak	Average
0.15 -0.5	66 - 56 *	56 - 46 *
0.50 -5.0	56.00	46.00
5.0 -30.0	60.00	50.00

TEST SETUP AND PROCEDURE

Refer to ANSI C63.10-2013 clause 6.2.

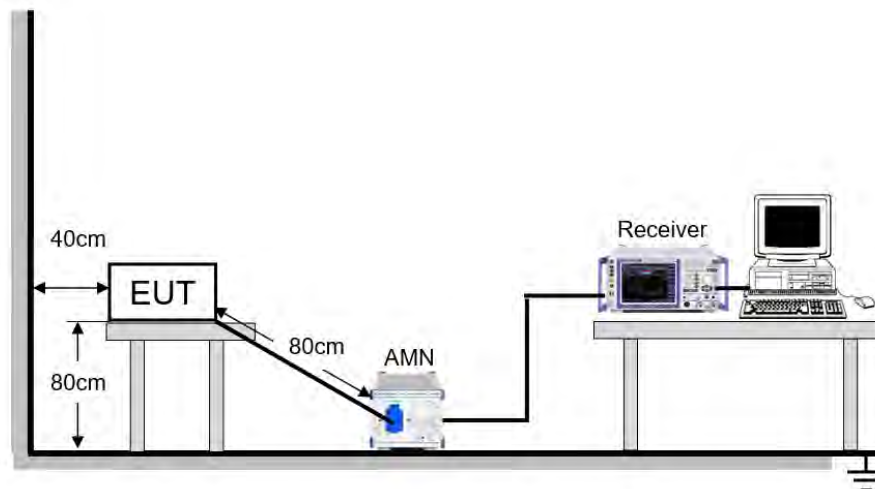

The EUT is put on a table of non-conducting material that is 80 cm high. The vertical conducting wall of shielding is located 40 cm to the rear of the EUT. The power line of the EUT is connected to the AC mains through a Artificial Mains Network (A.M.N.). A EMI Measurement Receiver (R&S Test Receiver ESR3) is used to test the emissions from both sides of AC line. According to the requirements in Section 6.2 of ANSI C63.10-2013. Conducted emissions from the EUT measured in the frequency range between 0.15 MHz and 30 MHz using CISPR Quasi-Peak and average detector mode. The bandwidth of EMI test receiver is set at 9 kHz.

The arrangement of the equipment is installed to meet the standards and operating in a manner, which tends to maximize its emission characteristics in a normal application.

TEST ENVIRONMENT

Temperature	23.6 °C	Relative Humidity	68.4 %
Atmosphere Pressure	101 kPa	Test Voltage	DC 5 V

RESULTS

9.1. 802.11n HT20 MIMO MODE

LINE N RESULTS (HIGH CHANNEL, WORST-CASE CONFIGURATION)

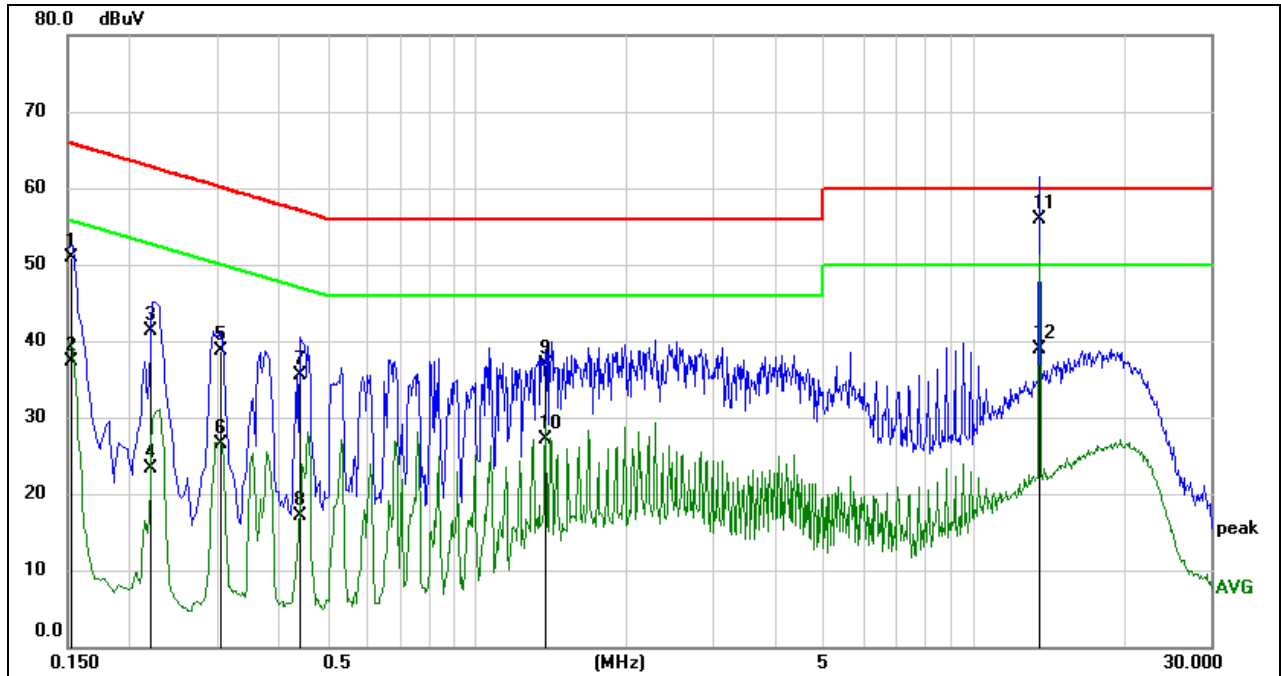

No.	Frequency (MHz)	Reading (dBuV)	Correct (dB)	Result (dBuV)	Limit (dBuV)	Margin (dB)	Remark
1	0.1521	41.33	9.59	50.92	65.88	-14.96	QP
2	0.1521	27.73	9.59	37.32	55.88	-18.56	AVG
3	0.2198	31.80	9.59	41.39	62.83	-21.44	QP
4	0.2198	13.67	9.59	23.26	52.83	-29.57	AVG
5	0.3053	29.14	9.59	38.73	60.10	-21.37	QP
6	0.3053	16.92	9.59	26.51	50.10	-23.59	AVG
7	0.4396	25.86	9.60	35.46	57.07	-21.61	QP
8	0.4396	7.43	9.60	17.03	47.07	-30.04	AVG
9	1.3752	27.20	9.61	36.81	56.00	-19.19	QP
10	1.3752	17.59	9.61	27.20	46.00	-18.80	AVG
11	13.5604	46.24	9.66	55.90	60.00	-4.10	QP
12	13.5604	29.29	9.66	38.95	50.00	-11.05	AVG

- Note: 1. Result = Reading +Correct Factor.
 2. If QP Result complies with AV limit, AV Result is deemed to comply with AV limit.
 3. Test setup: RBW: 200 Hz (9 kHz ~ 150 kHz), 9 kHz (150 kHz ~ 30 MHz).
 4. Step size: 80 Hz (0.009 MHz ~ 0.15 MHz), 4 kHz (0.15 MHz ~ 30 MHz), Scan time: auto.

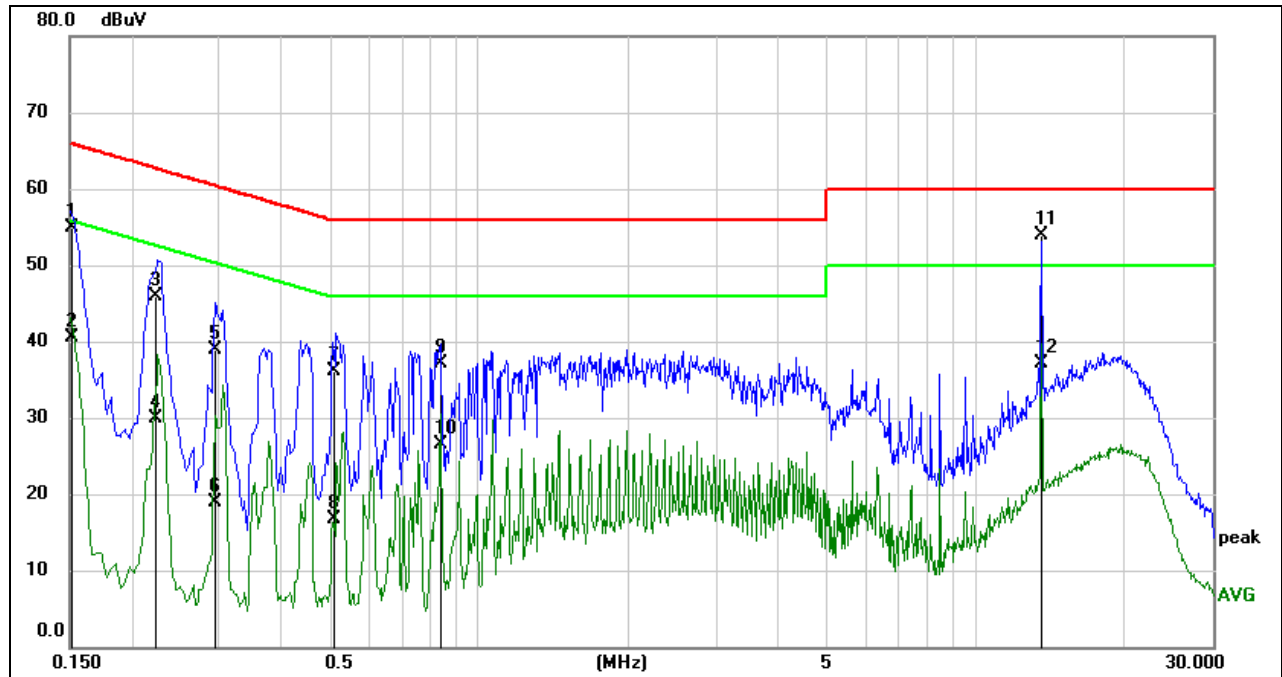
LINE L RESULTS (HIGH CHANNEL, WORST-CASE CONFIGURATION)

No.	Frequency (MHz)	Reading (dBuV)	Correct (dB)	Result (dBuV)	Limit (dBuV)	Margin (dB)	Remark
1	0.1522	45.36	9.59	54.95	65.88	-10.93	QP
2	0.1522	30.95	9.59	40.54	55.88	-15.34	AVG
3	0.2227	36.28	9.59	45.87	62.72	-16.85	QP
4	0.2227	20.22	9.59	29.81	52.72	-22.91	AVG
5	0.2929	29.35	9.59	38.94	60.44	-21.50	QP
6	0.2929	9.37	9.59	18.96	50.44	-31.48	AVG
7	0.5126	26.51	9.60	36.11	56.00	-19.89	QP
8	0.5126	7.19	9.60	16.79	46.00	-29.21	AVG
9	0.8397	27.57	9.60	37.17	56.00	-18.83	QP
10	0.8397	16.98	9.60	26.58	46.00	-19.42	AVG
11	13.5604	44.21	9.66	53.87	60.00	-6.13	QP
12	13.5604	27.54	9.66	37.20	50.00	-12.80	AVG

Note: 1. Result = Reading + Correct Factor.

2. If QP Result complies with AV limit, AV Result is deemed to comply with AV limit.

3. Test setup: RBW: 200 Hz (9 kHz ~ 150 kHz), 9 kHz (150 kHz ~ 30 MHz).

4. Step size: 80 Hz (0.009 MHz ~ 0.15 MHz), 4 kHz (0.15 MHz ~ 30 MHz), Scan time: auto.

Note: All the modes had been tested, but only the worst data was recorded in the report.



10. ANTENNA REQUIREMENTS

APPLICABLE REQUIREMENTS

Please refer to FCC §15.203

An intentional radiator shall be designed to ensure that no antenna other than that furnished by the responsible party shall be used with the device. The use of a permanently attached antenna or of an antenna that uses a unique coupling to the intentional radiator shall be considered sufficient to comply with the provisions of this section. The manufacturer may design the unit so that a broken antenna can be replaced by the user, but the use of a standard antenna jack or electrical connector is prohibited.

Please refer to FCC §15.247(b)(4)

The conducted output power limit specified in paragraph (b) of this section is based on the use of antennas with directional gains that do not exceed 6 dBi. Except as shown in paragraph (c) of this section, if transmitting antennas of directional gain greater than 6 dBi are used, the conducted output power from the intentional radiator shall be reduced below the stated values in paragraphs (b)(1), (b)(2), and (b)(3) of this section, as appropriate, by the amount in dB that the directional gain of the antenna exceeds 6 dBi.

RESULTS

Complies



11. Appendix

11.1. Appendix A: DTS Bandwidth

11.1.1. Test Result

Test Mode	Antenna	Channel	DTS BW [MHz]	FL[MHz]	FH[MHz]	Limit[MHz]	Verdict
11B	Ant1	2412	8.120	2407.920	2416.040	0.5	PASS
	Ant2	2412	9.120	2407.440	2416.560	0.5	PASS
	Ant1	2437	8.600	2432.440	2441.040	0.5	PASS
	Ant2	2437	8.640	2432.440	2441.080	0.5	PASS
	Ant1	2462	8.640	2457.400	2466.040	0.5	PASS
	Ant2	2462	8.600	2457.960	2466.560	0.5	PASS
11G	Ant1	2412	16.400	2403.800	2420.200	0.5	PASS
	Ant2	2412	16.400	2403.800	2420.200	0.5	PASS
	Ant1	2437	16.400	2428.800	2445.200	0.5	PASS
	Ant2	2437	16.400	2428.800	2445.200	0.5	PASS
	Ant1	2462	16.400	2453.800	2470.200	0.5	PASS
	Ant2	2462	16.400	2453.800	2470.200	0.5	PASS
11N20MIMO	Ant1	2412	17.640	2403.160	2420.800	0.5	PASS
	Ant2	2412	17.680	2403.160	2420.840	0.5	PASS
	Ant1	2437	17.680	2428.160	2445.840	0.5	PASS
	Ant2	2437	17.680	2428.160	2445.840	0.5	PASS
	Ant1	2462	17.680	2453.160	2470.840	0.5	PASS
	Ant2	2462	17.680	2453.160	2470.840	0.5	PASS

11.1.2. Test Graphs



11B Ant1 2412



11B Ant2 2412



11B Ant1 2437



11B Ant2 2437



11B Ant1 2462



11B Ant2 2462

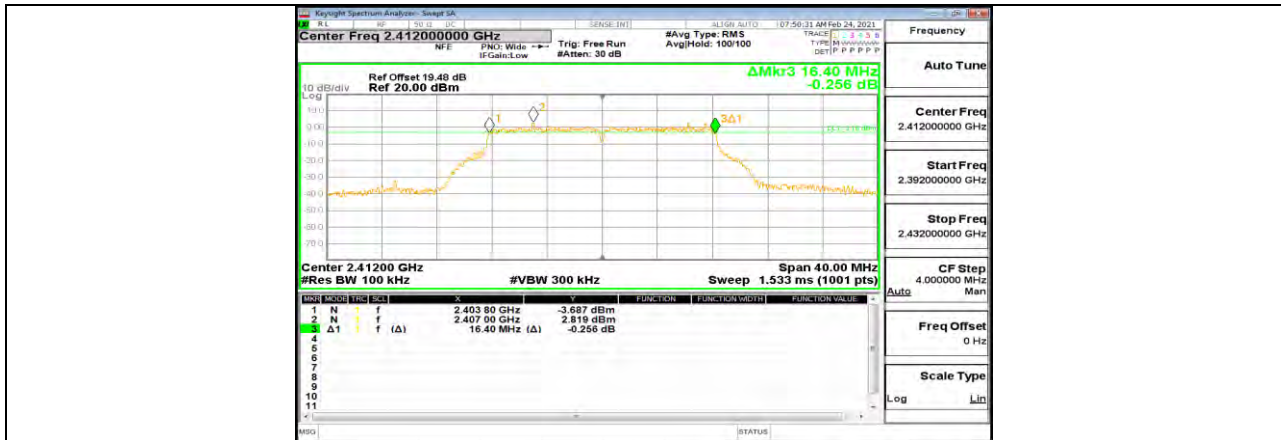

11G Ant1 2412



11G Ant2 2412



11G Ant1 2437

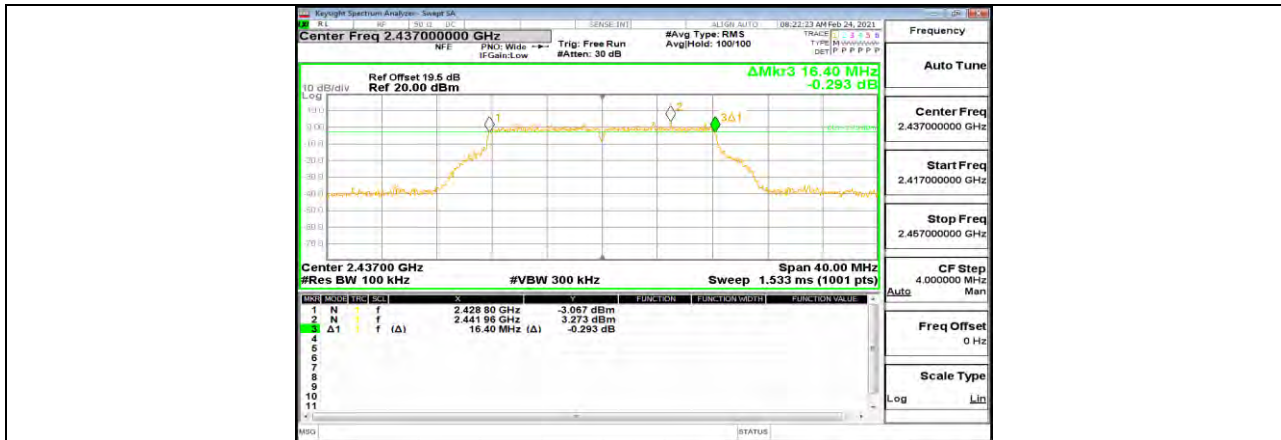

11G Ant2 2437



11G Ant1 2462



11G Ant2 2462



11N20MIMO Ant1 2412



11N20MIMO Ant2 2412



11N20MIMO Ant1 2437



11N20MIMO Ant2 2437



11N20MIMO Ant1 2462



11N20MIMO Ant2 2462



11.2. Appendix B: Occupied Channel Bandwidth

11.2.1. Test Result

Test Mode	Antenna	Channel	OCB [MHz]	FL[MHz]	FH[MHz]	Verdict
11B	Ant1	2412	11.656	2406.207	2417.863	PASS
	Ant2	2412	11.782	2406.169	2417.951	PASS
	Ant1	2437	11.624	2431.232	2442.856	PASS
	Ant2	2437	11.794	2431.160	2442.954	PASS
	Ant1	2462	11.611	2456.221	2467.832	PASS
	Ant2	2462	11.800	2456.140	2467.940	PASS
11G	Ant1	2412	17.379	2403.316	2420.695	PASS
	Ant2	2412	17.318	2403.391	2420.709	PASS
	Ant1	2437	17.486	2428.272	2445.758	PASS
	Ant2	2437	17.464	2428.270	2445.734	PASS
	Ant1	2462	17.480	2453.241	2470.721	PASS
	Ant2	2462	17.421	2453.270	2470.691	PASS
11N20MIMO	Ant1	2412	18.383	2402.805	2421.188	PASS
	Ant2	2412	18.156	2402.929	2421.085	PASS
	Ant1	2437	18.441	2427.846	2446.287	PASS
	Ant2	2437	18.094	2427.928	2446.022	PASS
	Ant1	2462	18.412	2452.808	2471.220	PASS
	Ant2	2462	18.163	2452.955	2471.118	PASS



11.2.2. Test Graphs



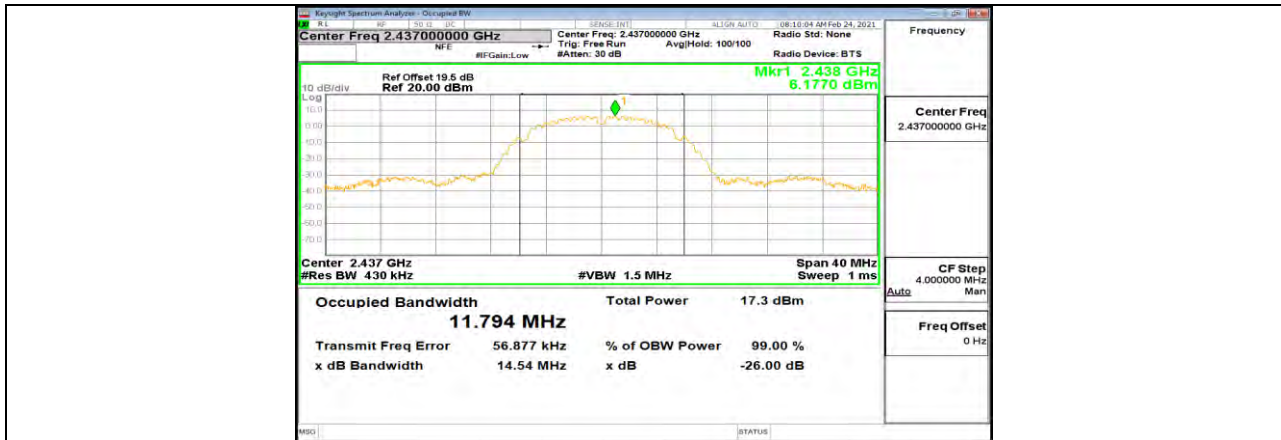

11B Ant2 2437

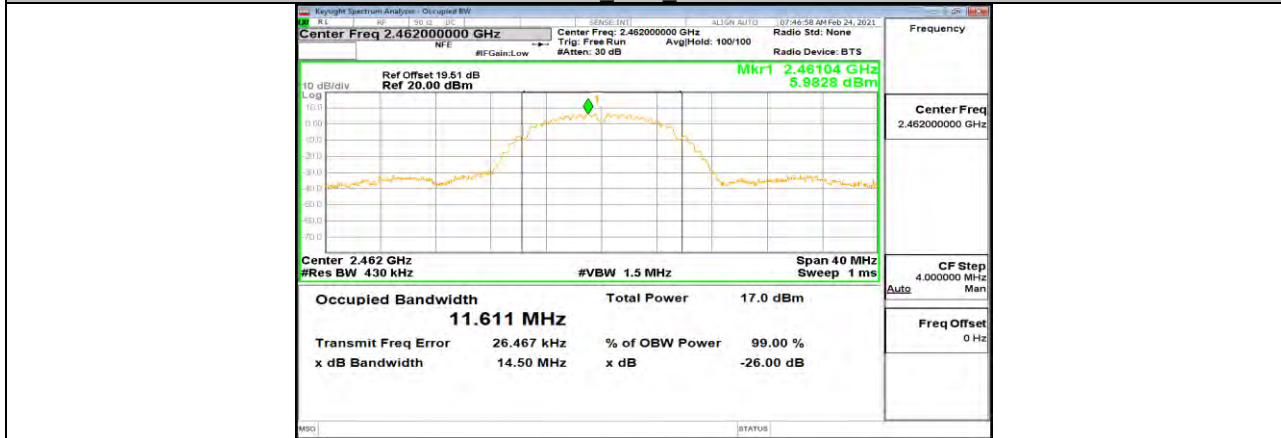

11B Ant1 2462

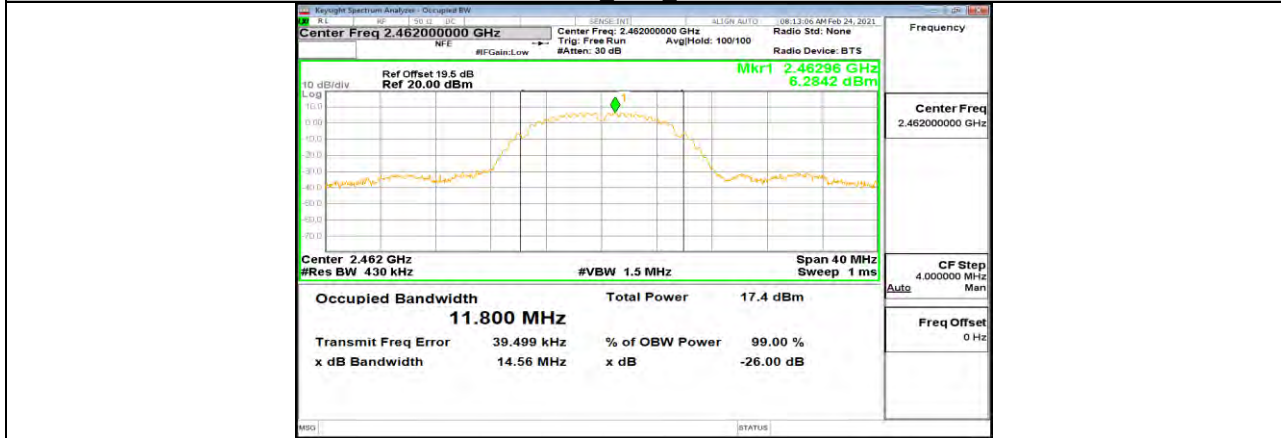

11B Ant2 2462

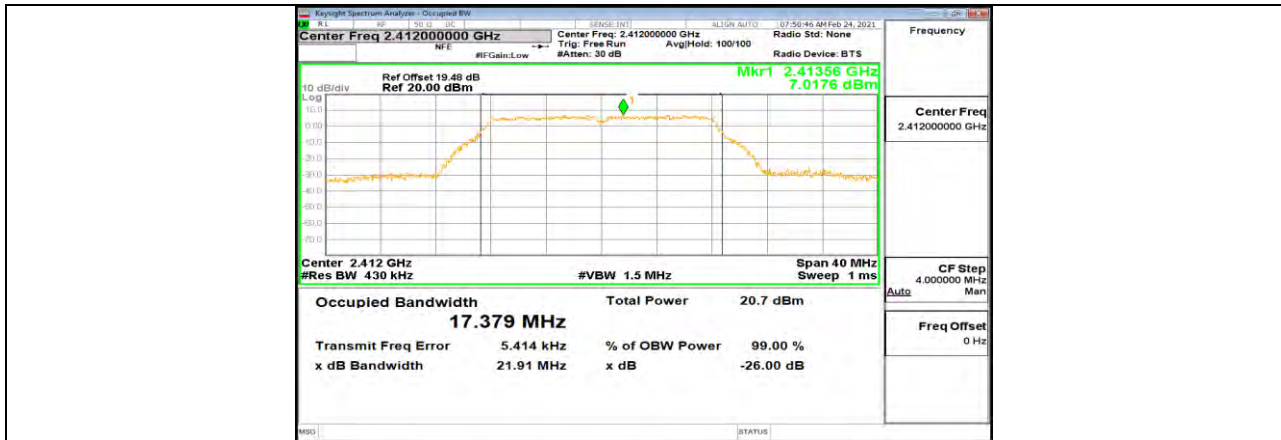

11G Ant1 2412

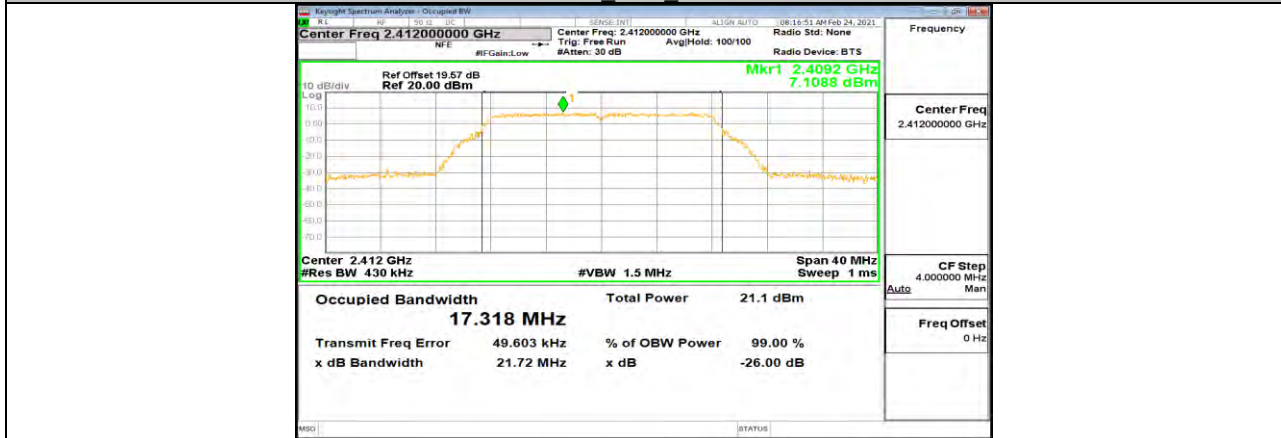

11G Ant2 2412

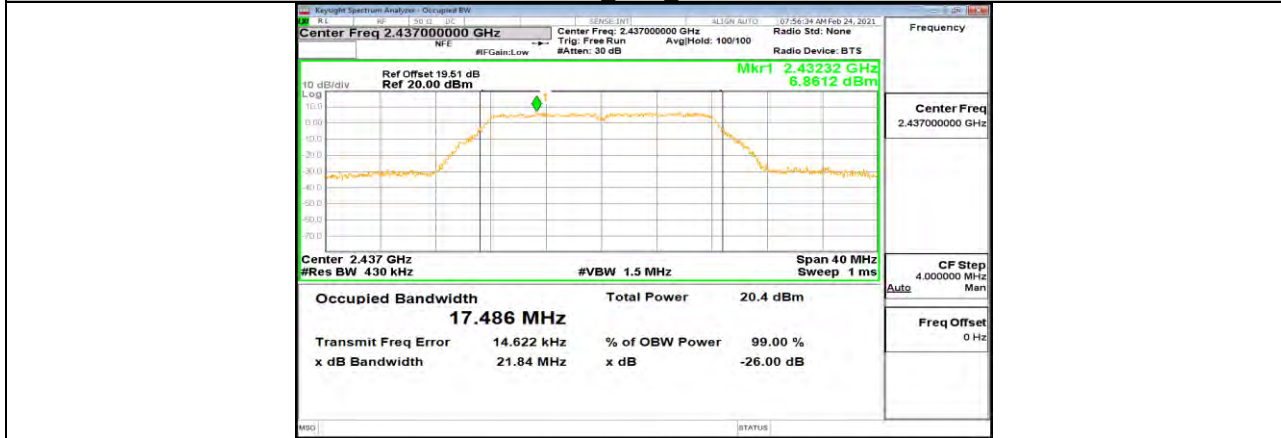

11G Ant1 2437

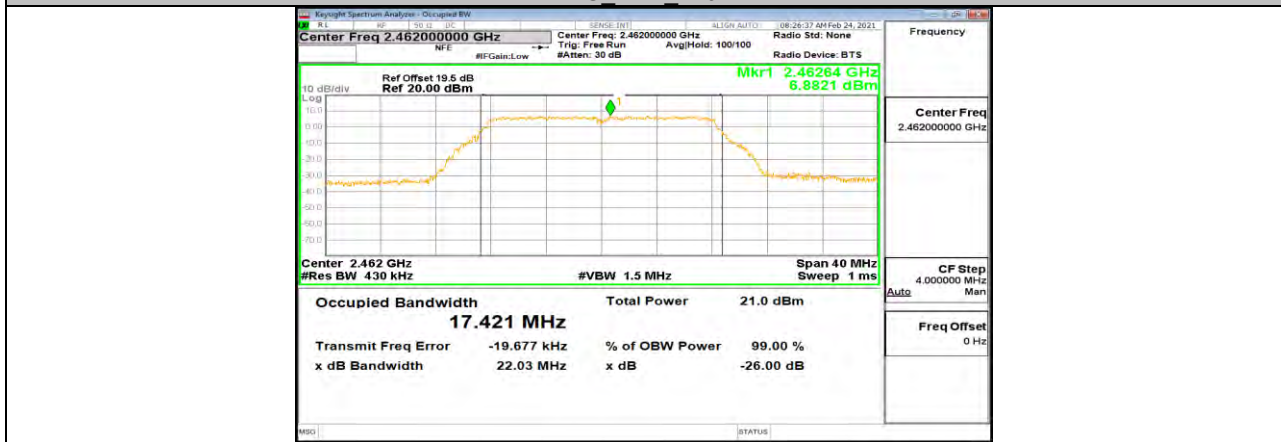
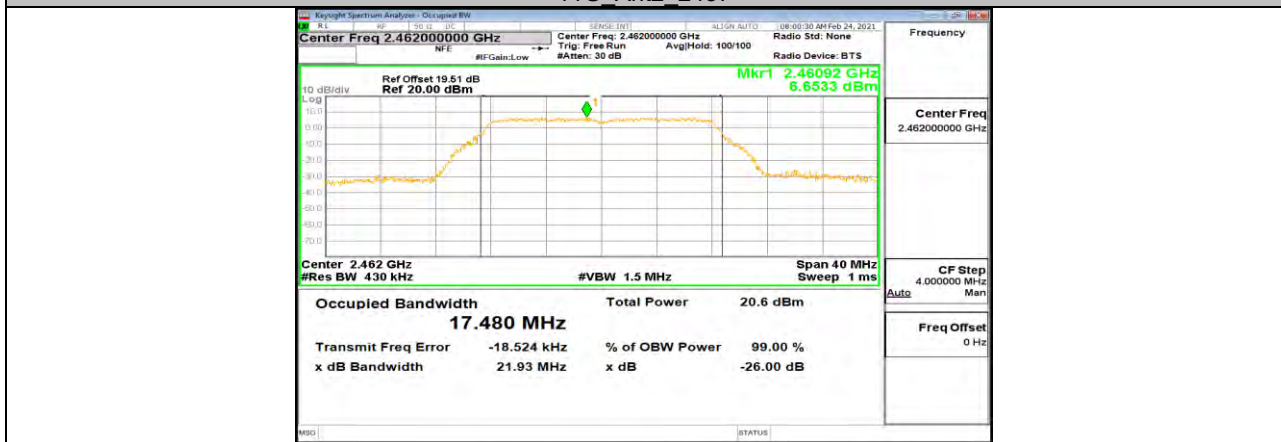
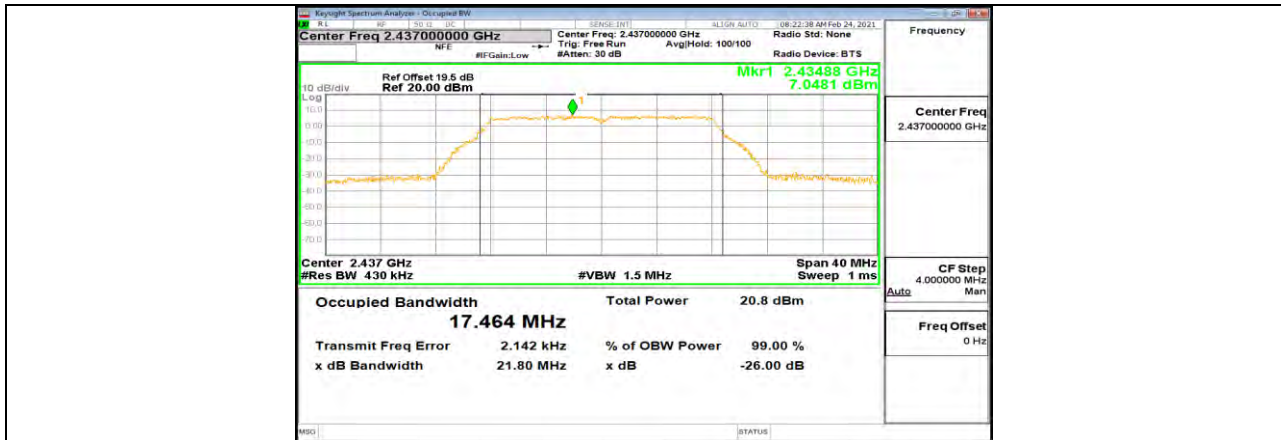

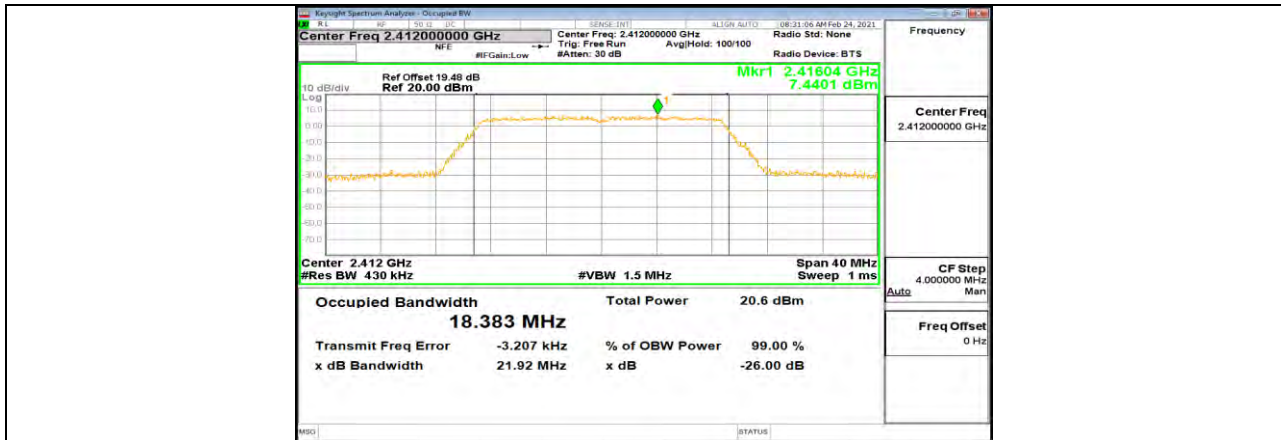

11N20MIMO Ant1 2412

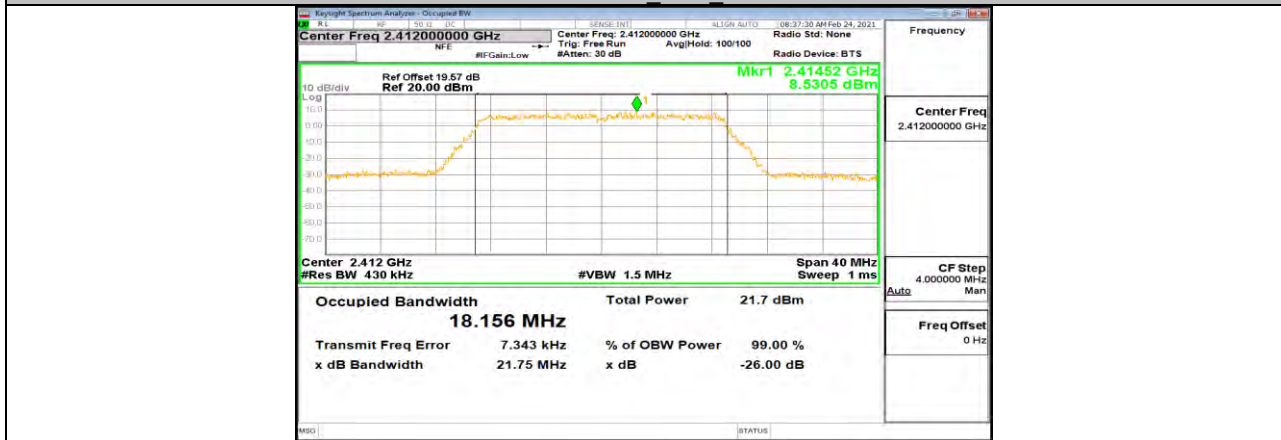

11N20MIMO Ant2 2412

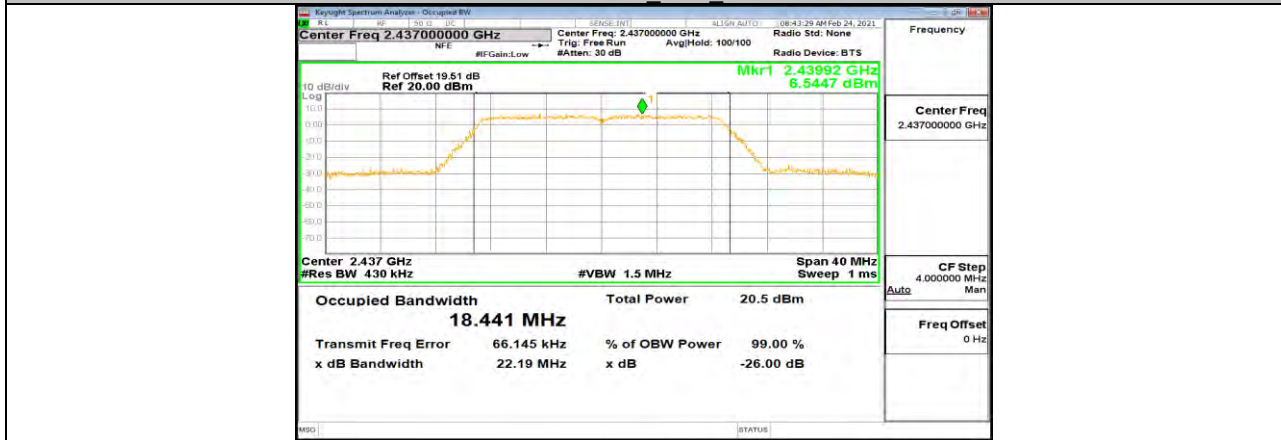

11N20MIMO Ant1 2437

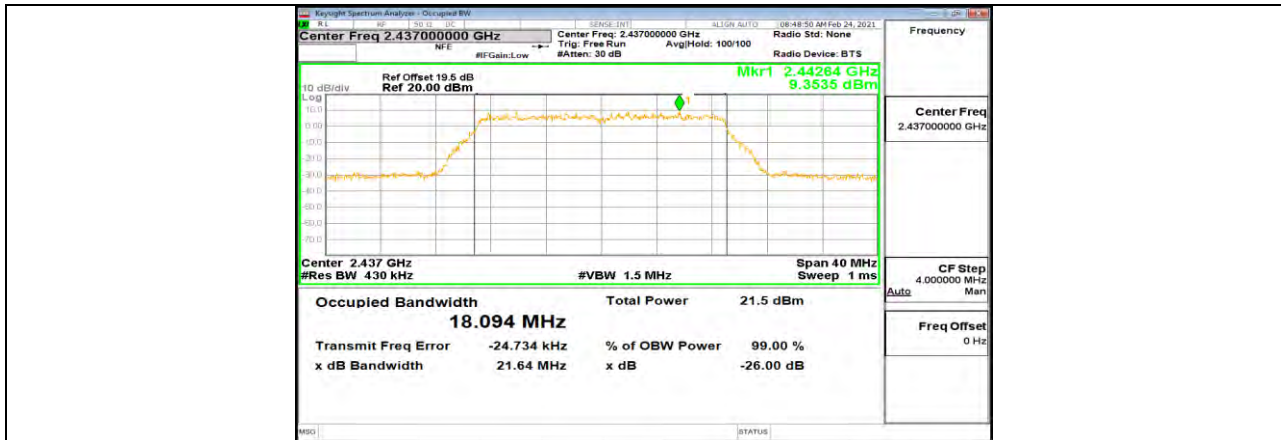

11N20MIMO Ant2 2437

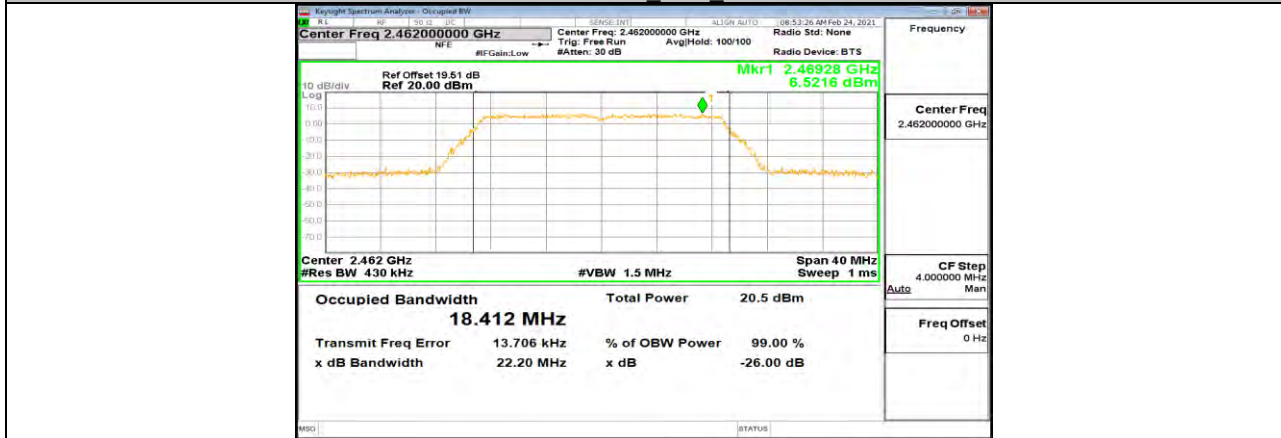

11N20MIMO Ant1 2462

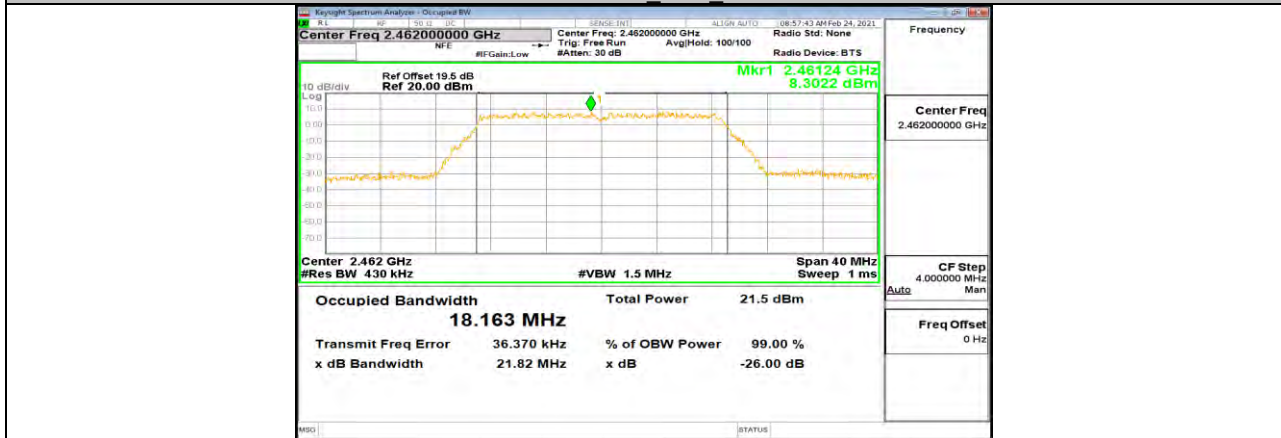

11N20MIMO Ant2 2462

**11.3. Appendix C: Maximum conducted output power****11.3.1. Test Result**

Test Mode	Antenna	Channel	Power [dBm]	Limit [dBm]	Limit [dBm]	EIRP [dBm]	Limit [dBm]	Verdict
11B	Ant1	2412	11.59	<=30	<=30	13.75	<=36	PASS
	Ant2	2412	12.58	<=30	<=30	14.78	<=36	PASS
	Ant1	2437	11.72	<=30	<=30	13.88	<=36	PASS
	Ant2	2437	12.46	<=30	<=30	14.66	<=36	PASS
	Ant1	2462	11.77	<=30	<=30	13.93	<=36	PASS
	Ant2	2462	12.51	<=30	<=30	14.71	<=36	PASS
11G	Ant1	2412	12.31	<=30	<=30	14.47	<=36	PASS
	Ant2	2412	13.40	<=30	<=30	15.60	<=36	PASS
	Ant1	2437	12.37	<=30	<=30	14.53	<=36	PASS
	Ant2	2437	13.10	<=30	<=30	15.30	<=36	PASS
	Ant1	2462	12.33	<=30	<=30	14.49	<=36	PASS
	Ant2	2462	13.27	<=30	<=30	15.47	<=36	PASS
11N20MIMO	Ant1	2412	12.13	<=30	<=30	14.29	<=36	PASS
	Ant2	2412	13.12	<=30	<=30	15.32	<=36	PASS
	total	2412	15.66	<=30	<=30	21.49	<=36	PASS
	Ant1	2437	12.24	<=30	<=30	14.4	<=36	PASS
	Ant2	2437	12.95	<=30	<=30	15.15	<=36	PASS
	total	2437	15.62	<=30	<=30	21.45	<=36	PASS
	Ant1	2462	12.21	<=30	<=30	14.37	<=36	PASS
	Ant2	2462	13.20	<=30	<=30	15.4	<=36	PASS
total	2462	15.74	<=30	<=30	21.57	<=36	PASS	



11.4. Appendix D: Maximum power spectral density

11.4.1. Test Result

Test Mode	Antenna	Channel	Result[dBm/3-100kHz]	Limit[dBm/3kHz]	Verdict
11B	Ant1	2412	-10.33	<=8	PASS
	Ant2	2412	-9.44	<=8	PASS
	Ant1	2437	-10.58	<=8	PASS
	Ant2	2437	-10.15	<=8	PASS
	Ant1	2462	-9.1	<=8	PASS
	Ant2	2462	-9.9	<=8	PASS
11G	Ant1	2412	-12.84	<=8	PASS
	Ant2	2412	-11.74	<=8	PASS
	Ant1	2437	-12.9	<=8	PASS
	Ant2	2437	-12.05	<=8	PASS
	Ant1	2462	-12.46	<=8	PASS
	Ant2	2462	-11.53	<=8	PASS
11N20MIMO	Ant1	2412	-11.12	<=8	PASS
	Ant2	2412	-11.56	<=8	PASS
	total	2412	-8.32	<=8	PASS
	Ant1	2437	-12.19	<=8	PASS
	Ant2	2437	-11.8	<=8	PASS
	total	2437	-8.98	<=8	PASS
	Ant1	2462	-12.92	<=8	PASS
	Ant2	2462	-11.97	<=8	PASS
total	2462	-9.41	<=8	PASS	

11.4.2. Test Graphs

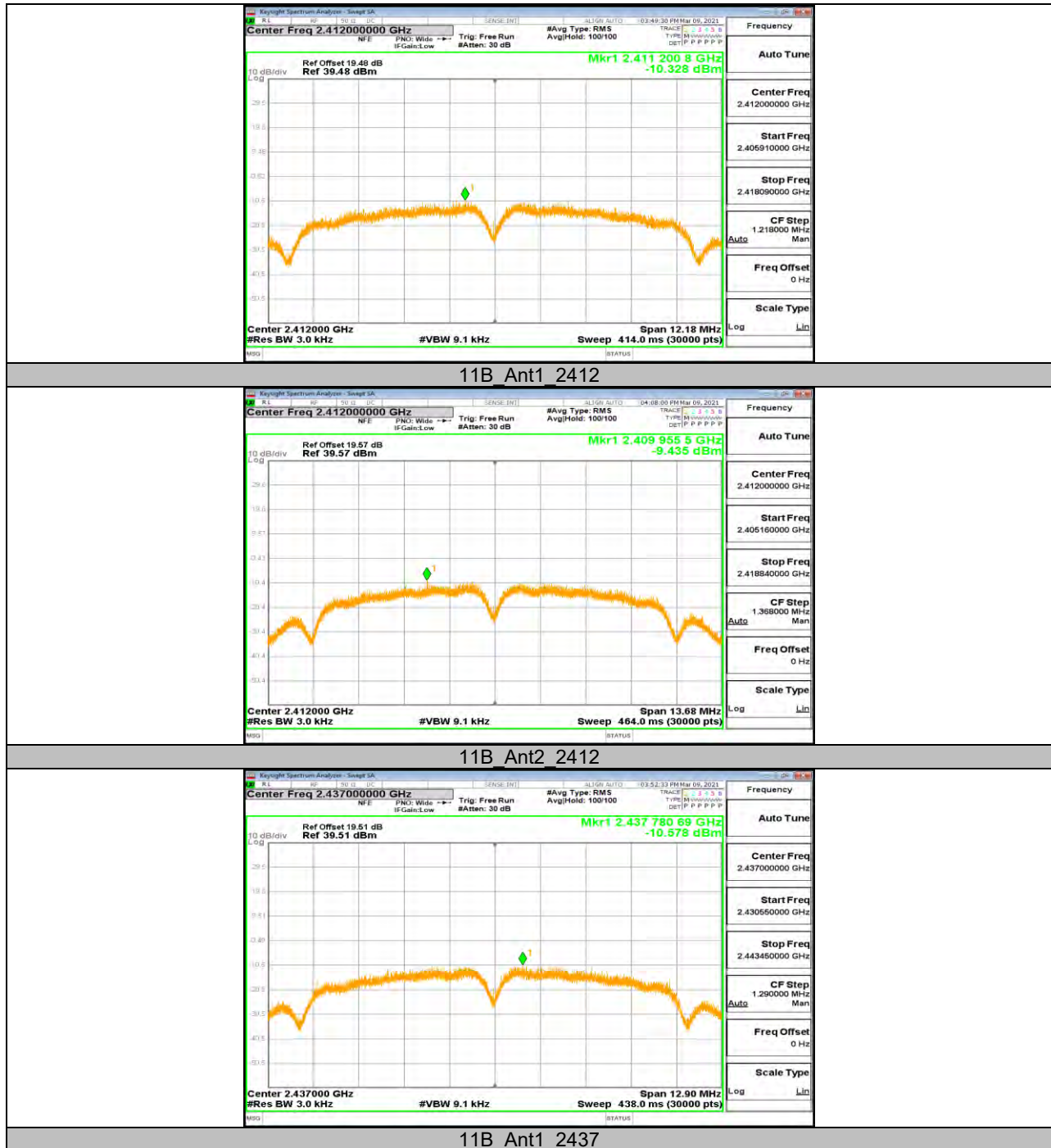



11B Ant2 2437



11B Ant1 2462



11B Ant2 2462

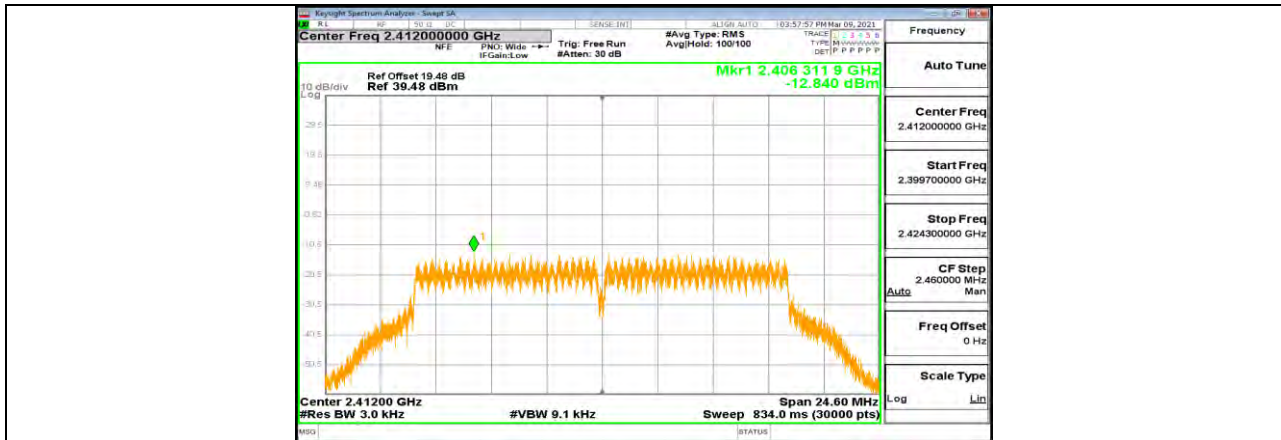

11G Ant1 2412



11G Ant2 2412



11G Ant1 2437



11G Ant2 2437



11G Ant1 2462



11G Ant2 2462

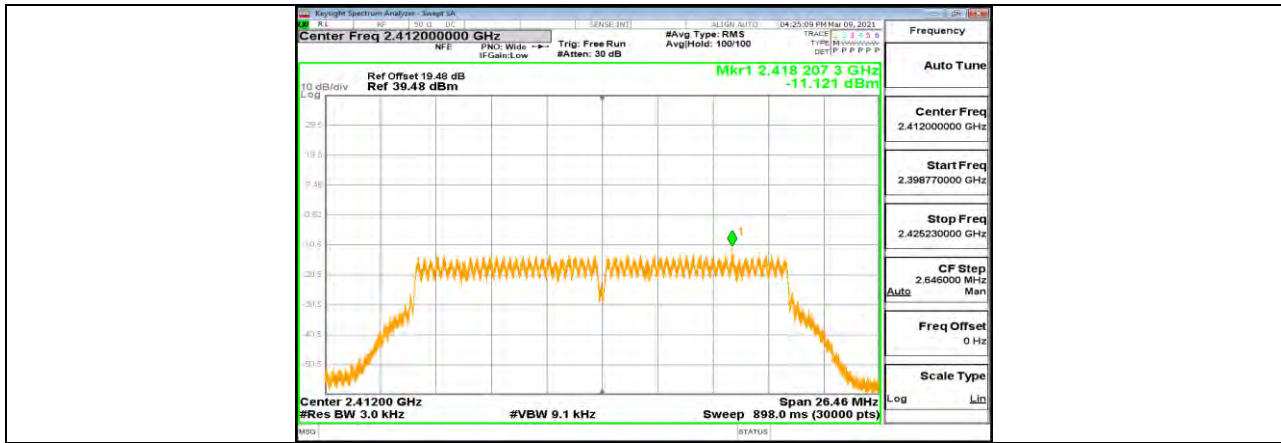

11N20MIMO Ant1 2412



11N20MIMO Ant2 2412



11N20MIMO Ant1 2437

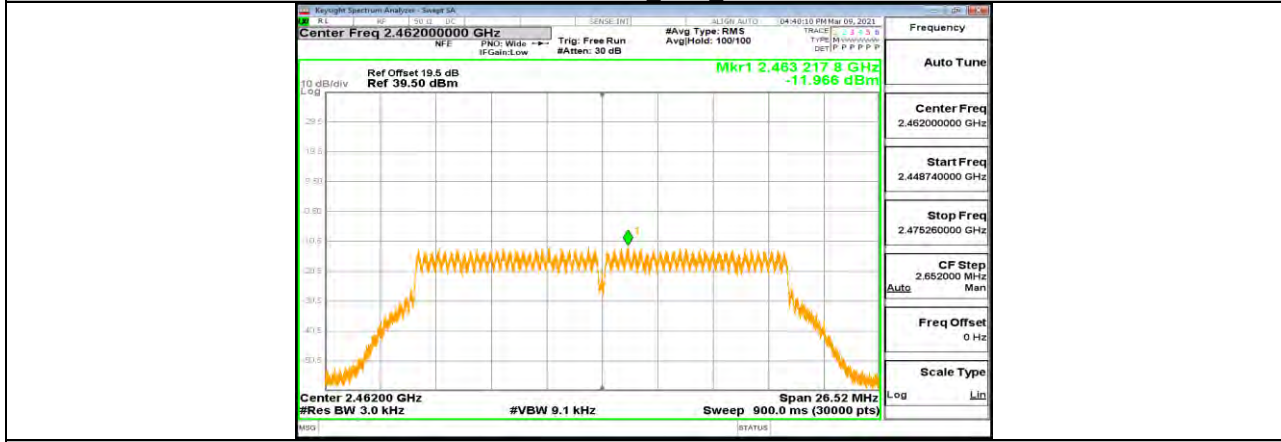
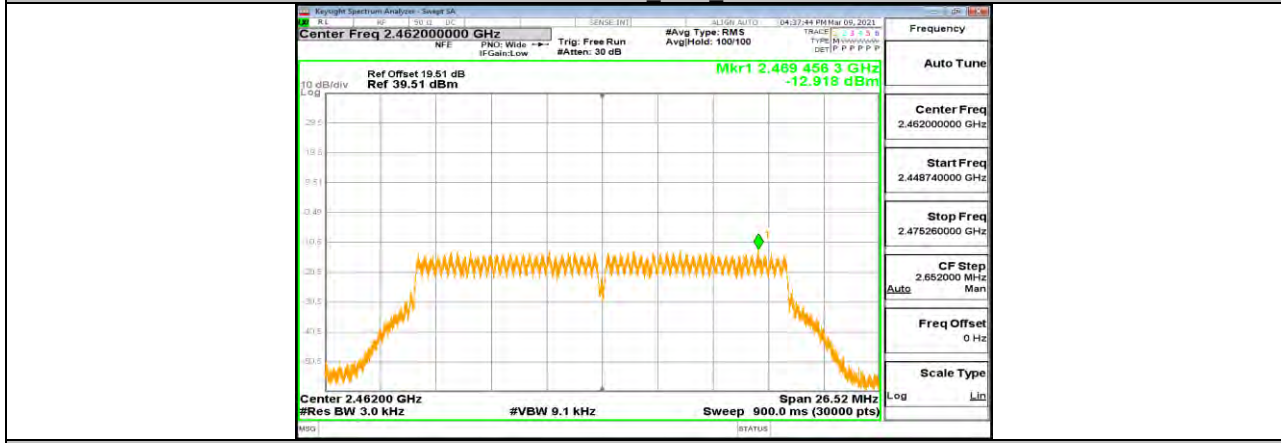



11.5. Appendix E: Band edge measurements
11.5.1. Test Result

Test Mode	Antenna	ChName	Channel	RefLevel[dBm]	Result[dBm]	Limit[dBm]	Verdict
11B	Ant1	Low	2412	5.48	-36.27	<=-24.53	PASS
	Ant2	Low	2412	5.87	-34.14	<=-24.14	PASS
	Ant1	High	2462	5.65	-40.53	<=-24.35	PASS
	Ant2	High	2462	5.86	-40.94	<=-24.14	PASS
11G	Ant1	Low	2412	3.27	-33.38	<=-26.74	PASS
	Ant2	Low	2412	3.95	-33.5	<=-26.06	PASS
	Ant1	High	2462	2.93	-39.18	<=-27.07	PASS
	Ant2	High	2462	3.68	-39.7	<=-26.32	PASS
11N20MIMO	Ant1	Low	2412	3.18	-32.48	<=-26.82	PASS
	Ant2	Low	2412	4.29	-32.01	<=-25.71	PASS
	Ant1	High	2462	3.32	-37.17	<=-26.68	PASS
	Ant2	High	2462	3.59	-38.18	<=-26.41	PASS

11.5.2. Test Graphs

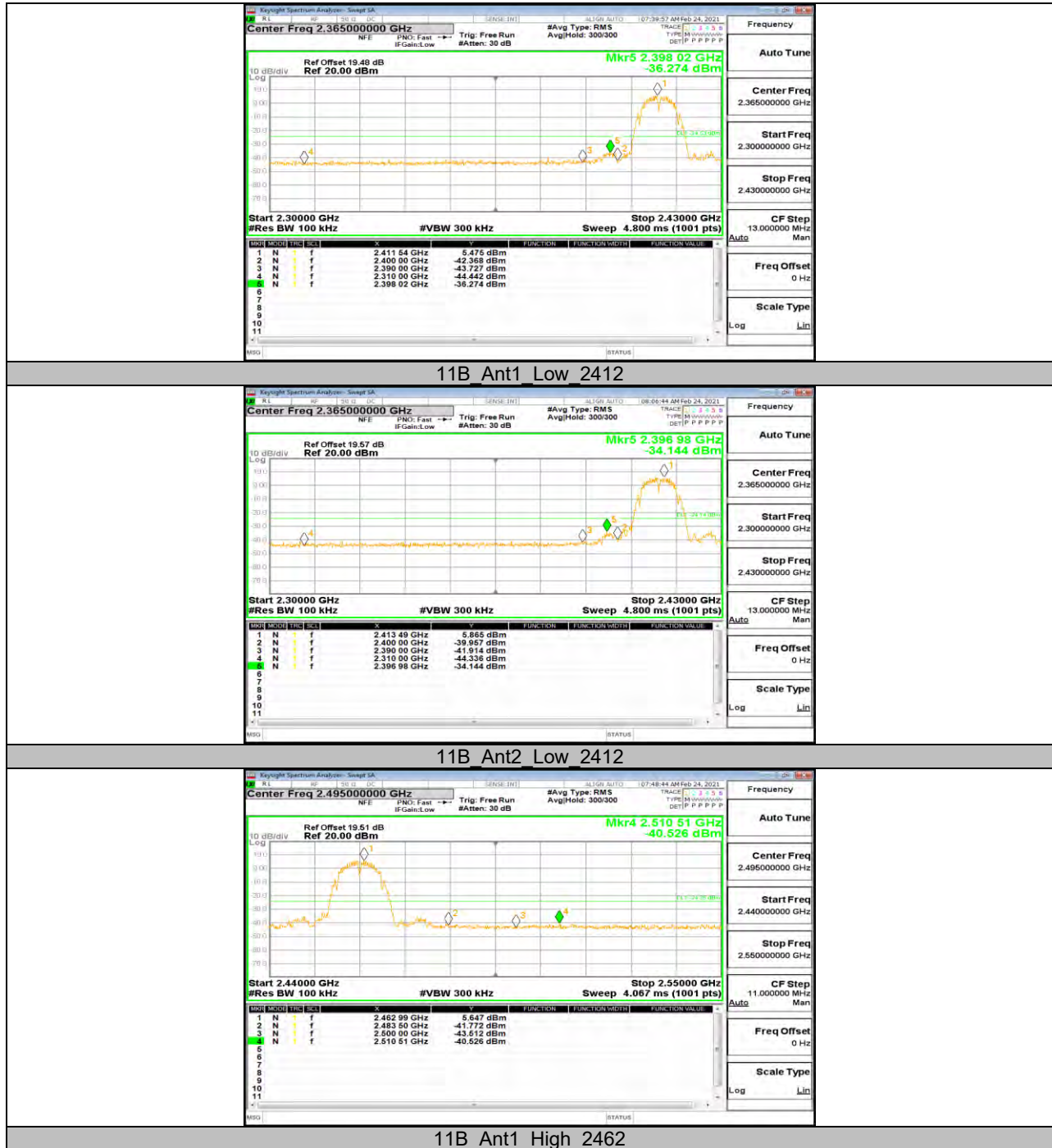



11B Ant2 High 2462

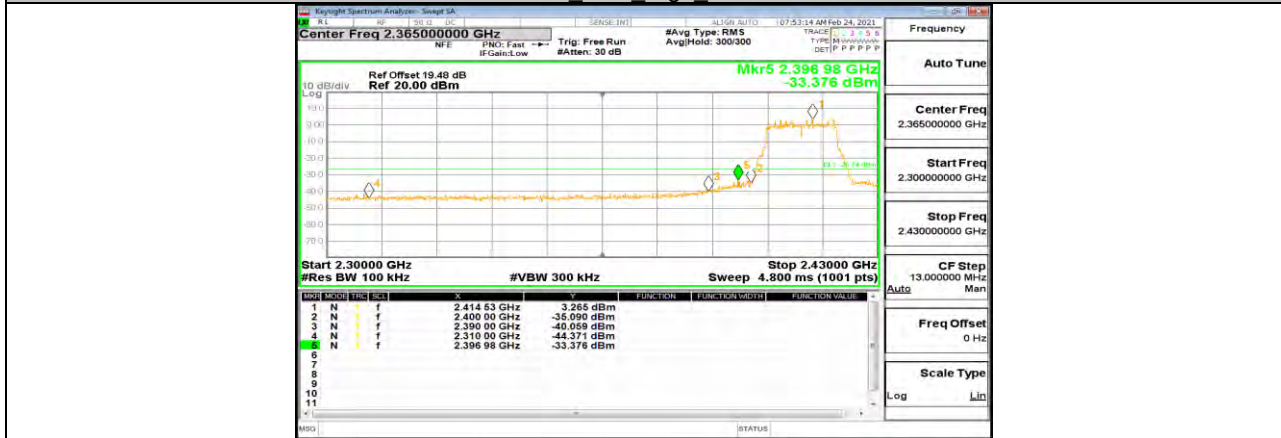

11G Ant1 Low 2412

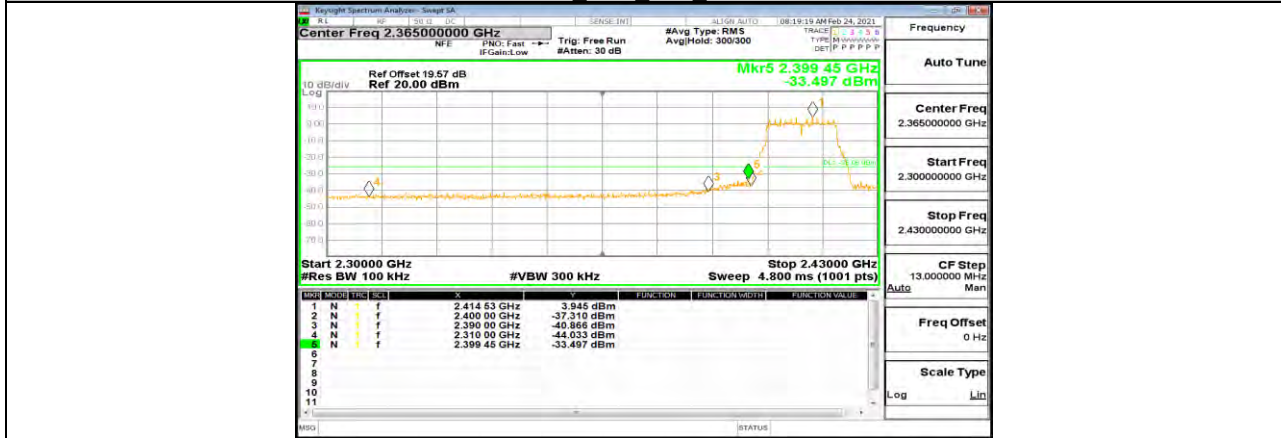

11G Ant2 Low 2412



11G Ant1 High 2462



11G Ant2 High 2462

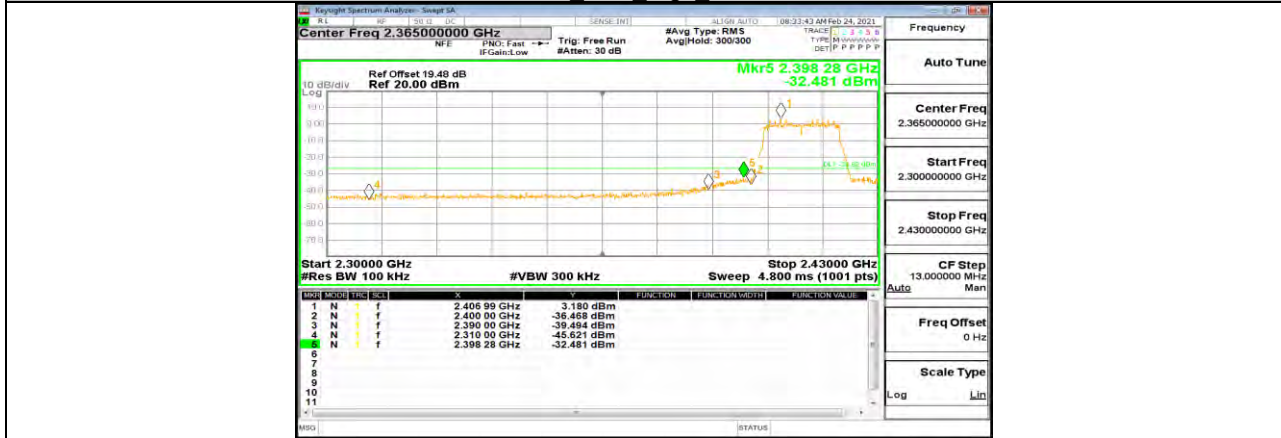

11N20MIMO Ant1 Low 2412

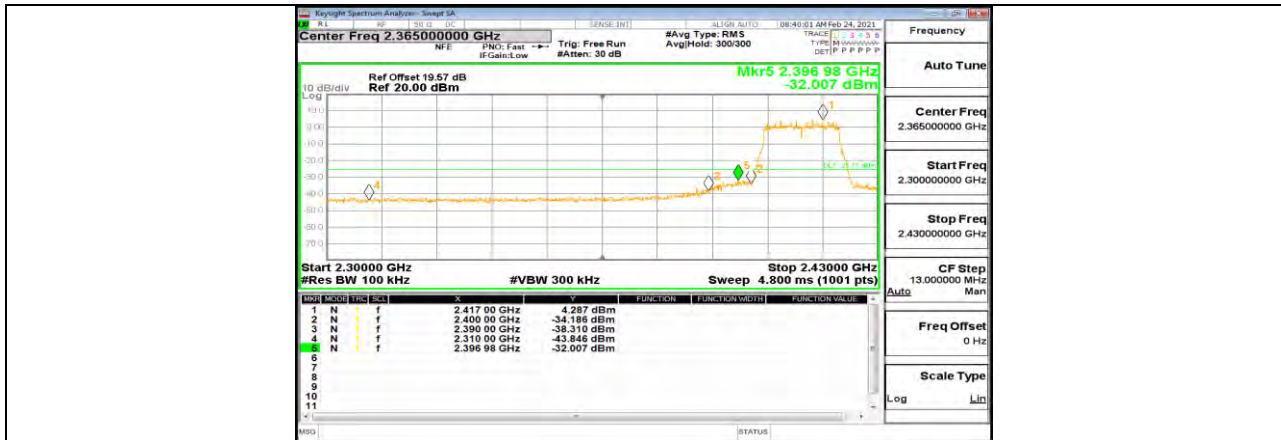

11N20MIMO Ant2 Low 2412



11N20MIMO Ant1 High 2462



11N20MIMO Ant2 High 2462

11.6. Appendix F: Conducted Spurious Emission

11.6.1. Test Result

Test Mode	Antenna	Channel	FreqRange [Mhz]	RefLevel [dBm]	Result [dBm]	Limit [dBm]	Verdict
11B	Ant1	2412	Reference	5.83	5.83	---	PASS
			30~1000	---	-53.74	<=-24.17	PASS
			1000~26500	---	-44.73	<=-24.17	PASS
	Ant2	2412	Reference	5.82	5.82	---	PASS
			30~1000	---	-53	<=-24.19	PASS
			1000~26500	---	-43.49	<=-24.19	PASS
	Ant1	2437	Reference	5.23	5.23	---	PASS
			30~1000	---	-54.3	<=-24.77	PASS
			1000~26500	---	-44.66	<=-24.77	PASS
	Ant2	2437	Reference	4.93	4.93	---	PASS
			30~1000	---	-53.4	<=-25.07	PASS
			1000~26500	---	-43.58	<=-25.07	PASS
	Ant1	2462	Reference	5.62	5.62	---	PASS
			30~1000	---	-52.23	<=-24.38	PASS
			1000~26500	---	-45.04	<=-24.38	PASS
	Ant2	2462	Reference	4.87	4.87	---	PASS
			30~1000	---	-53.09	<=-25.13	PASS
			1000~26500	---	-44.78	<=-25.13	PASS
11G	Ant1	2412	Reference	3.34	3.34	---	PASS
			30~1000	---	-53.85	<=-26.66	PASS
			1000~26500	---	-44.27	<=-26.66	PASS
	Ant2	2412	Reference	3.76	3.76	---	PASS
			30~1000	---	-53.69	<=-26.24	PASS
			1000~26500	---	-44.81	<=-26.24	PASS
	Ant1	2437	Reference	2.89	2.89	---	PASS
			30~1000	---	-52.85	<=-27.11	PASS
			1000~26500	---	-44.71	<=-27.11	PASS
	Ant2	2437	Reference	3.27	3.27	---	PASS
			30~1000	---	-52.99	<=-26.73	PASS
			1000~26500	---	-44.88	<=-26.73	PASS
	Ant1	2462	Reference	3.02	3.02	---	PASS
			30~1000	---	-53.38	<=-26.98	PASS
			1000~26500	---	-44.7	<=-26.98	PASS
	Ant2	2462	Reference	3.33	3.33	---	PASS
			30~1000	---	-53.38	<=-26.67	PASS
			1000~26500	---	-44.26	<=-26.67	PASS
11B-CDD	Ant1	2412	Reference	5.28	5.28	---	PASS
			30~1000	---	-51.77	<=-24.72	PASS
			1000~26500	---	-44.43	<=-24.72	PASS
	Ant2	2412	Reference	5.73	5.73	---	PASS
			30~1000	---	-53.36	<=-24.27	PASS
			1000~26500	---	-44.08	<=-24.27	PASS
	Ant1	2437	Reference	4.47	4.47	---	PASS
			30~1000	---	-52.93	<=-25.53	PASS
			1000~26500	---	-44.62	<=-25.53	PASS
	Ant2	2437	Reference	5.55	5.55	---	PASS
			30~1000	---	-53.13	<=-24.45	PASS
			1000~26500	---	-44.58	<=-24.45	PASS
	Ant1	2462	Reference	5.38	5.38	---	PASS
			30~1000	---	-51.93	<=-24.63	PASS
			1000~26500	---	-44.38	<=-24.63	PASS
	Ant2	2462	Reference	5.68	5.68	---	PASS
			30~1000	---	-52.65	<=-24.32	PASS



11G-CDD	Ant1	2412	1000~26500	---	-44.58	<=-24.32	PASS
			Reference	3.01	3.01	---	PASS
			30~1000	---	-53.61	<=-26.99	PASS
	Ant2	2412	1000~26500	---	-44.04	<=-26.99	PASS
			Reference	3.63	3.63	---	PASS
			30~1000	---	-53.29	<=-26.37	PASS
	Ant1	2437	1000~26500	---	-44.63	<=-26.37	PASS
			Reference	2.98	2.98	---	PASS
			30~1000	---	-53.06	<=-27.02	PASS
	Ant2	2437	1000~26500	---	-44.09	<=-27.02	PASS
			Reference	3.41	3.41	---	PASS
			30~1000	---	-53.23	<=-26.59	PASS
	Ant1	2462	1000~26500	---	-44.94	<=-26.59	PASS
			Reference	2.74	2.74	---	PASS
			30~1000	---	-53.71	<=-27.26	PASS
	Ant2	2462	1000~26500	---	-44.53	<=-27.26	PASS
			Reference	3.66	3.66	---	PASS
			30~1000	---	-52.83	<=-26.34	PASS
11N20MIMO	Ant1	2412	1000~26500	---	-44.18	<=-26.34	PASS
			Reference	3.16	3.16	---	PASS
			30~1000	---	-53.47	<=-26.84	PASS
	Ant2	2412	1000~26500	---	-44.56	<=-26.84	PASS
			Reference	3.75	3.75	---	PASS
			30~1000	---	-52.4	<=-26.25	PASS
	Ant1	2437	1000~26500	---	-45.08	<=-26.25	PASS
			Reference	3.25	3.25	---	PASS
			30~1000	---	-53.28	<=-26.75	PASS
	Ant2	2437	1000~26500	---	-44.87	<=-26.75	PASS
			Reference	3.31	3.31	---	PASS
			30~1000	---	-53.14	<=-26.69	PASS
	Ant1	2462	1000~26500	---	-43.73	<=-26.69	PASS
			Reference	3.12	3.12	---	PASS
			30~1000	---	-53.8	<=-26.88	PASS
	Ant2	2462	1000~26500	---	-44.52	<=-26.88	PASS
			Reference	2.83	2.83	---	PASS
			30~1000	---	-53.11	<=-27.17	PASS
			1000~26500	---	-42.93	<=-27.17	PASS

11.6.2. Test Graphs

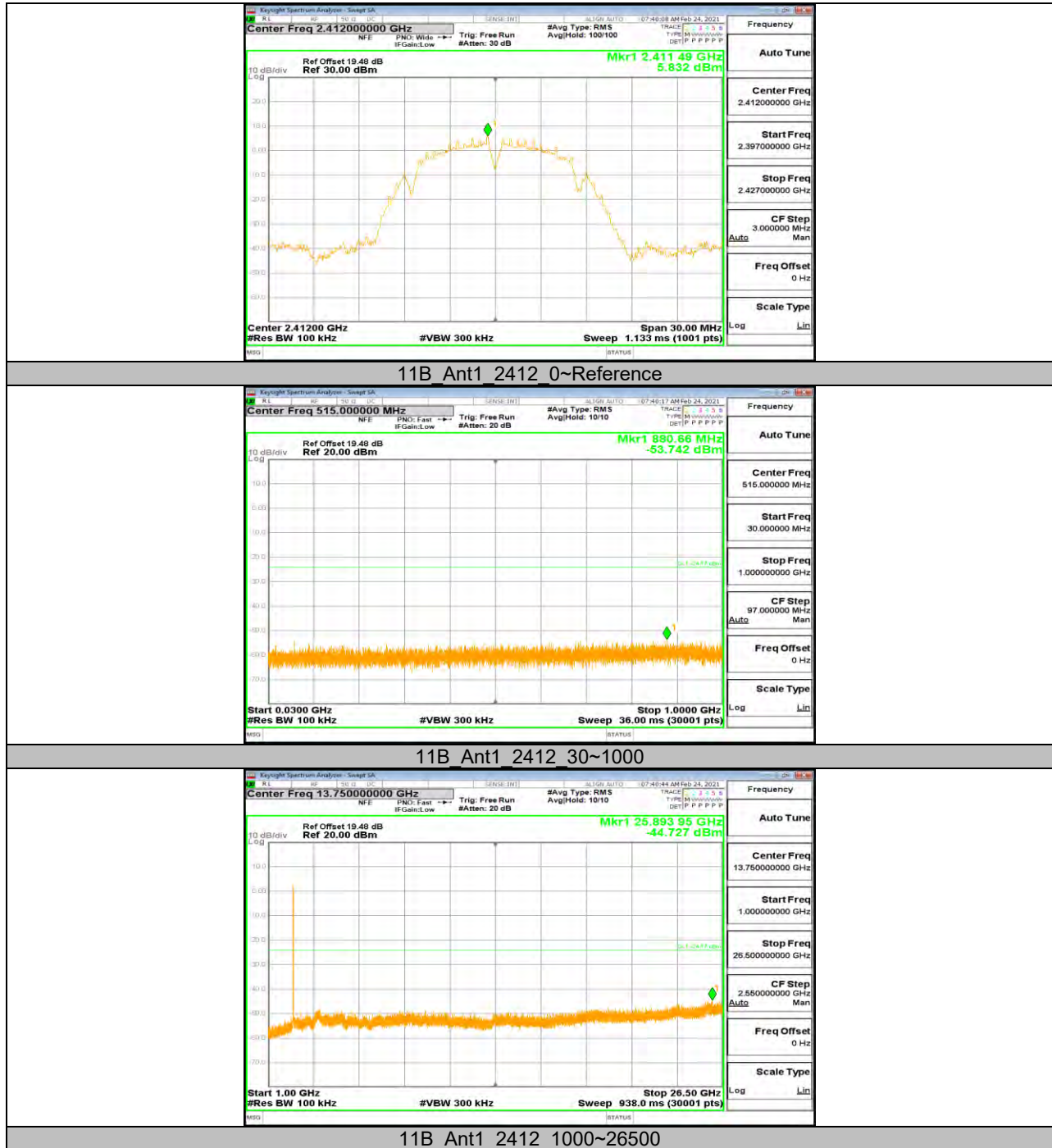



11B Ant2 2412 0-Reference

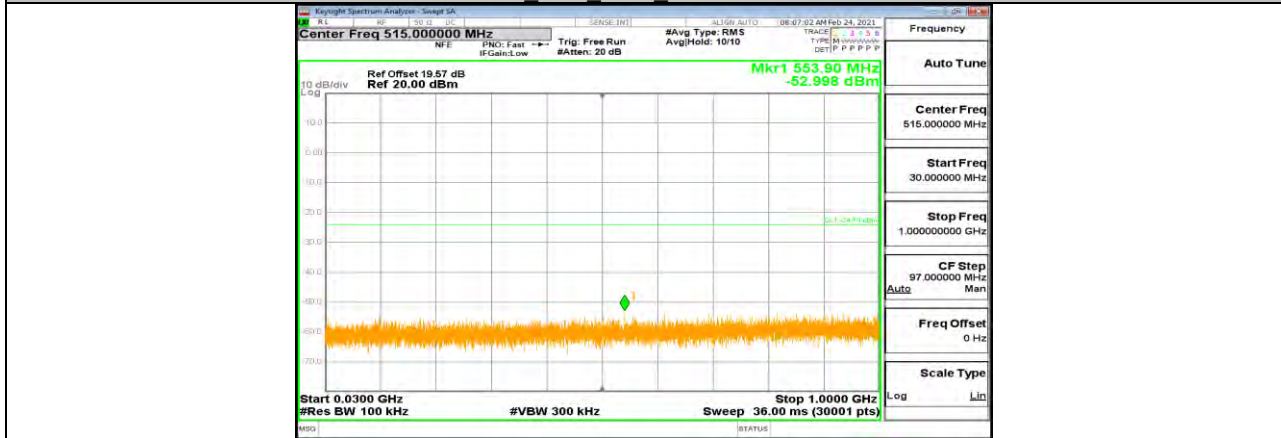

11B Ant2 2412 30~1000

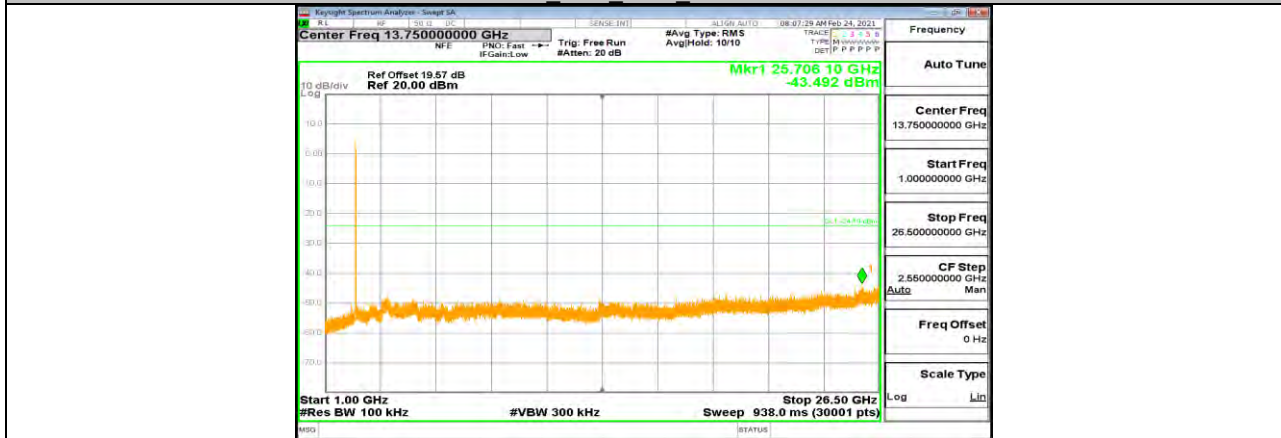

11B Ant2 2412 1000~26500



11B Ant1 2437 0-Reference

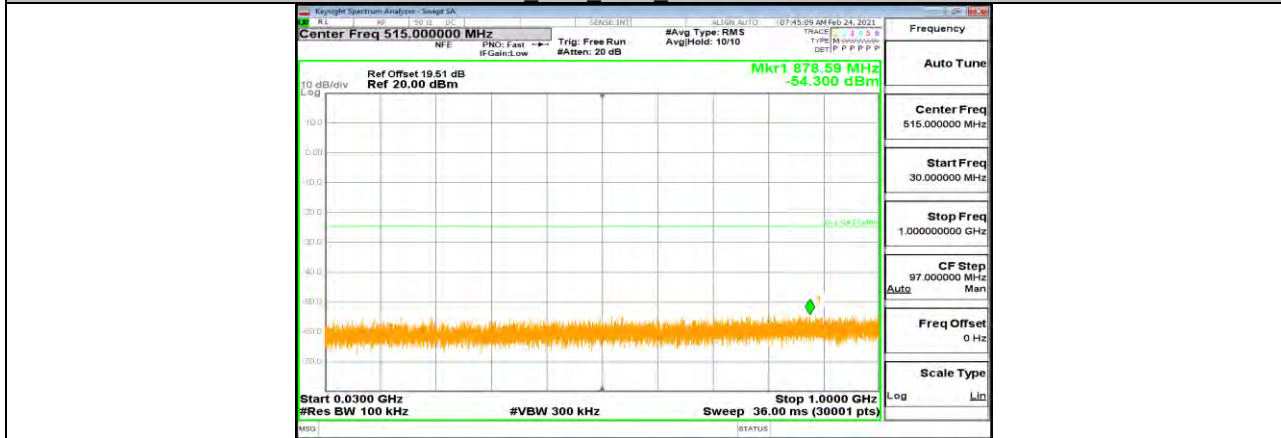

11B Ant1 2437 30-1000

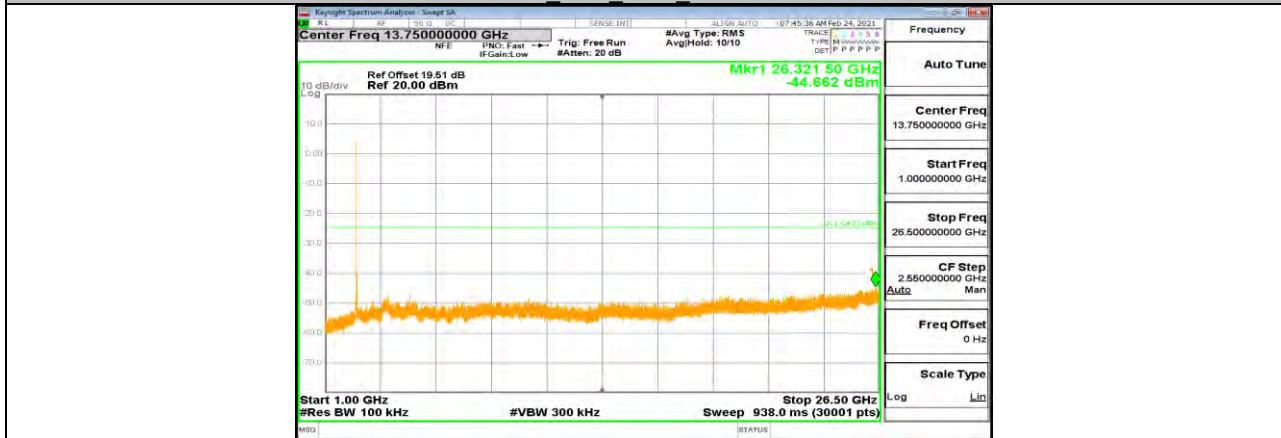

11B Ant1 2437 1000-26500



11B Ant2 2437 0-Reference

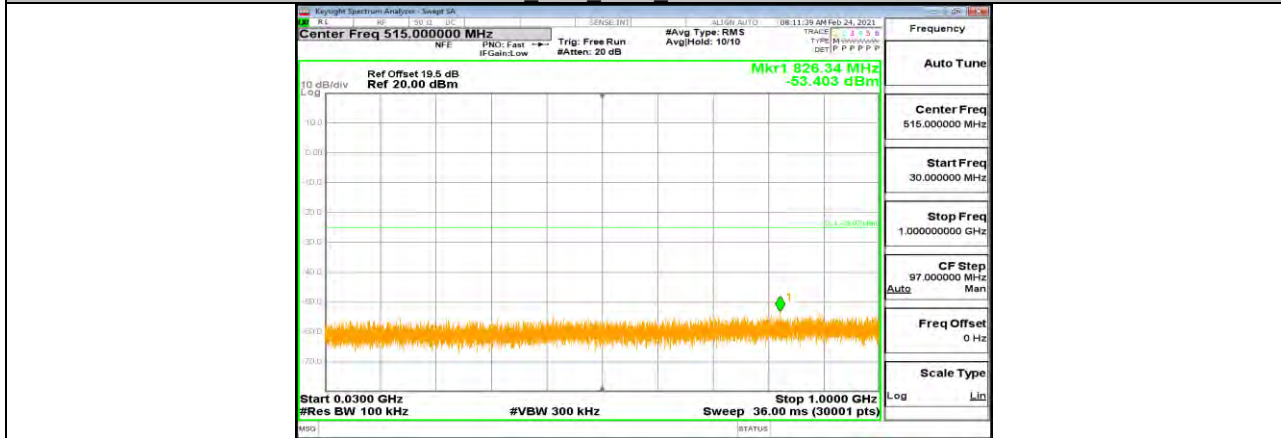

11B Ant2 2437 30~1000

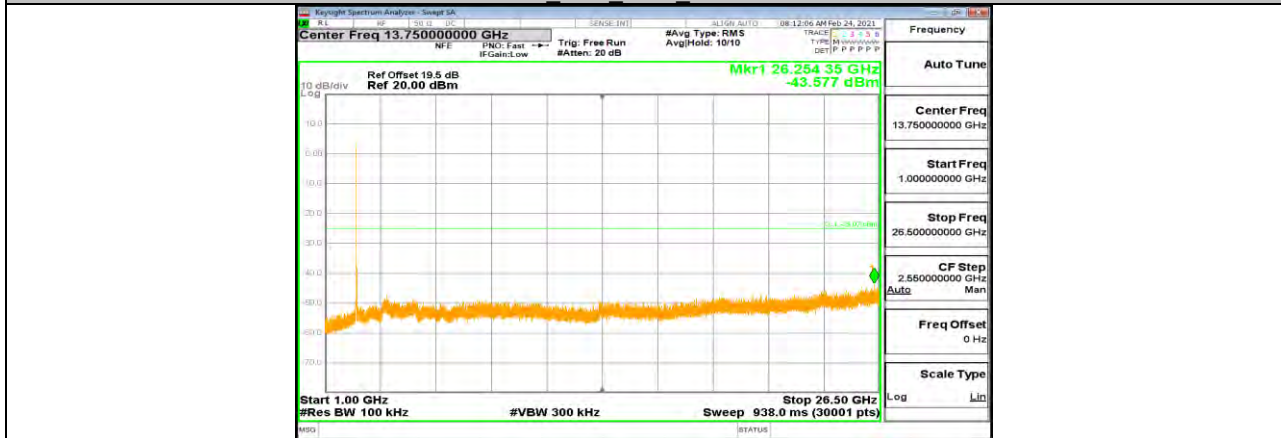

11B Ant2 2437 1000~26500



11B Ant1 2462 0-Reference

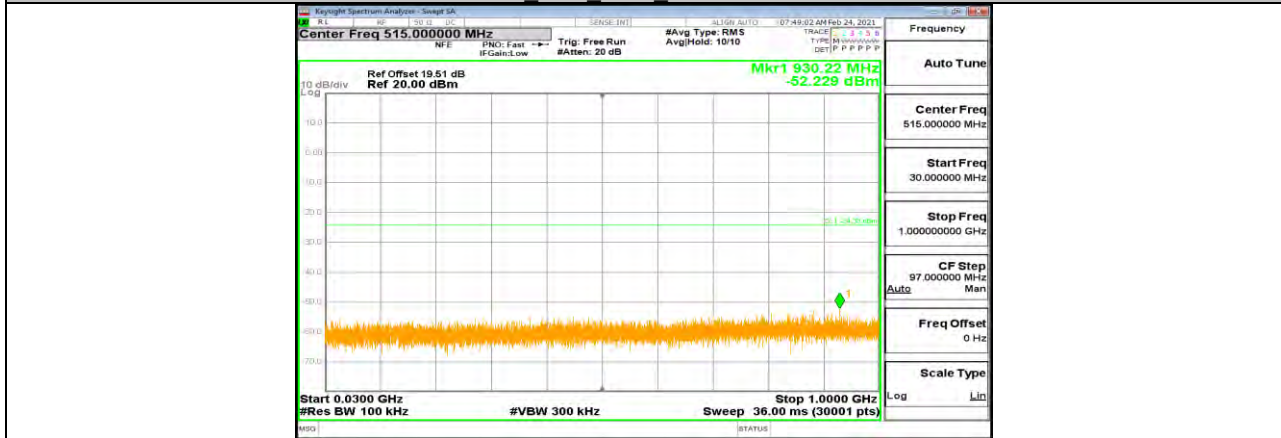

11B Ant1 2462 30~1000

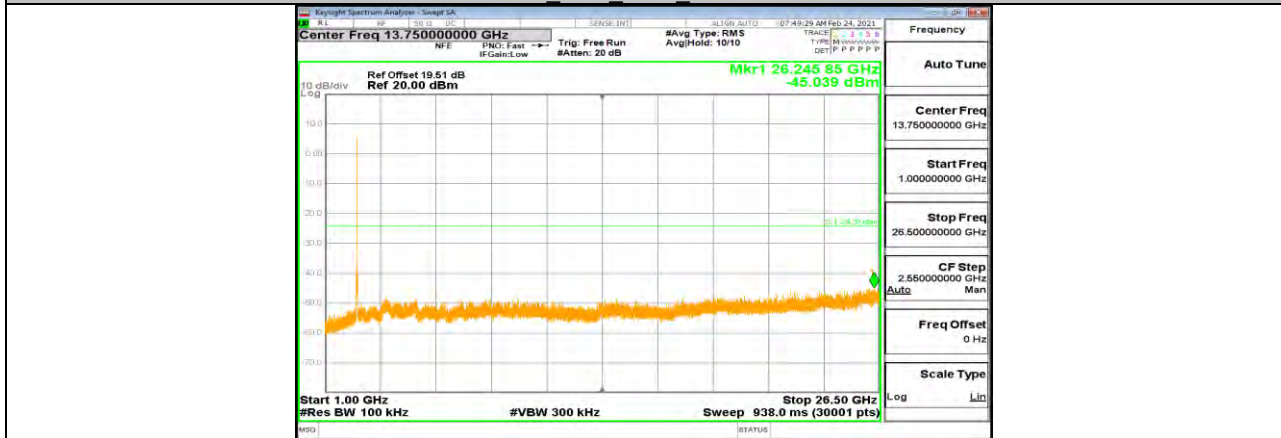

11B Ant1 2462 1000~26500



11B Ant2 2462 0-Reference

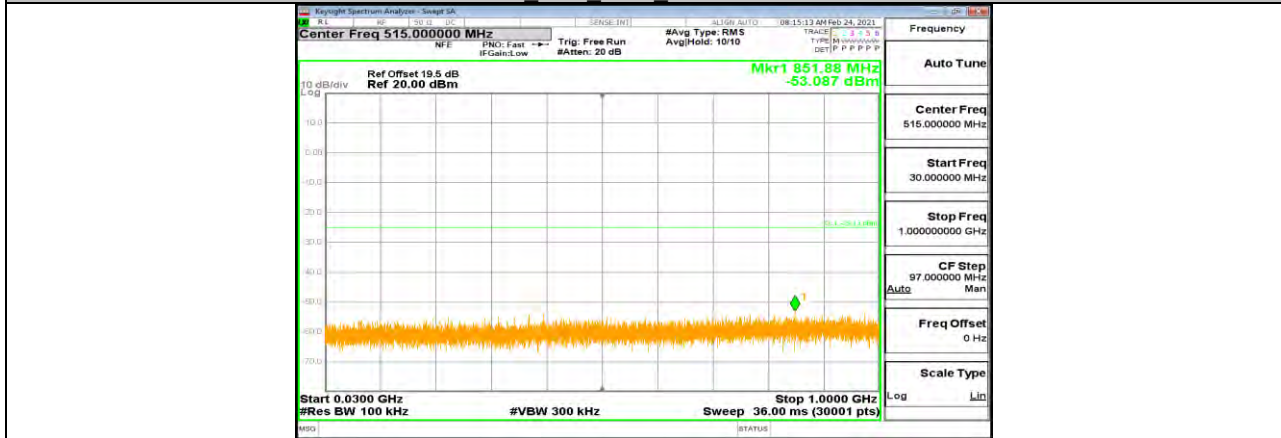

11B Ant2 2462 30-1000

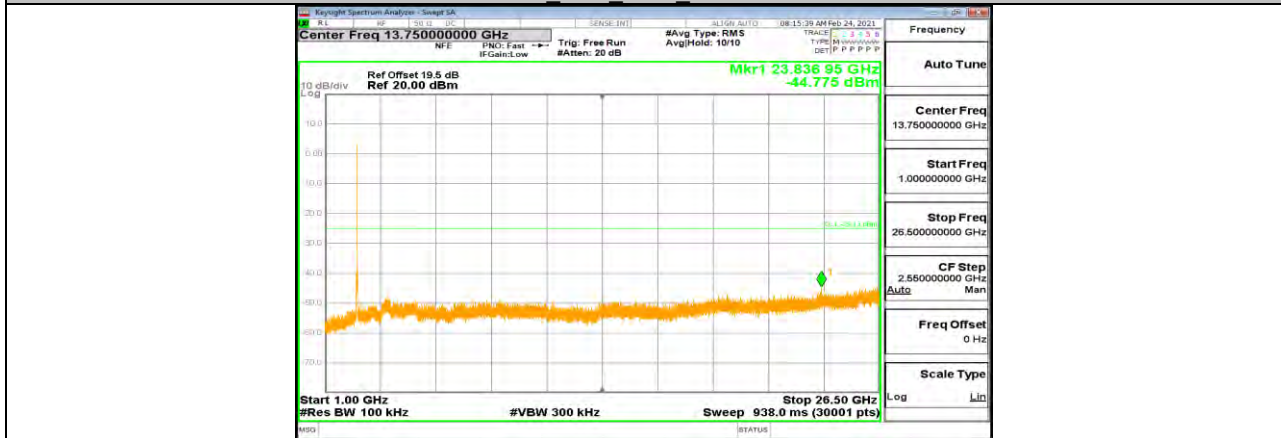

11B Ant2 2462 1000-26500



11G Ant1 2412 0-Reference

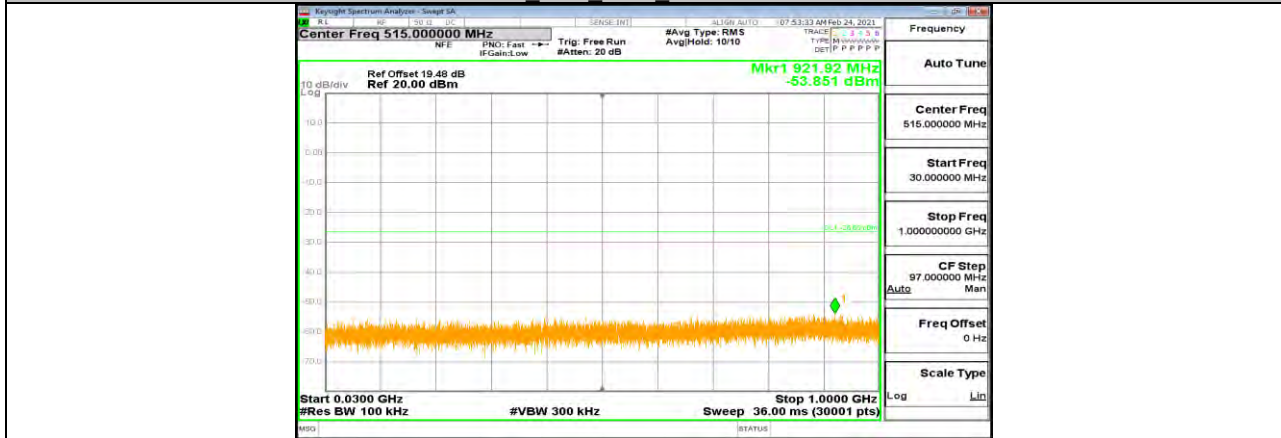

11G Ant1 2412 30~1000

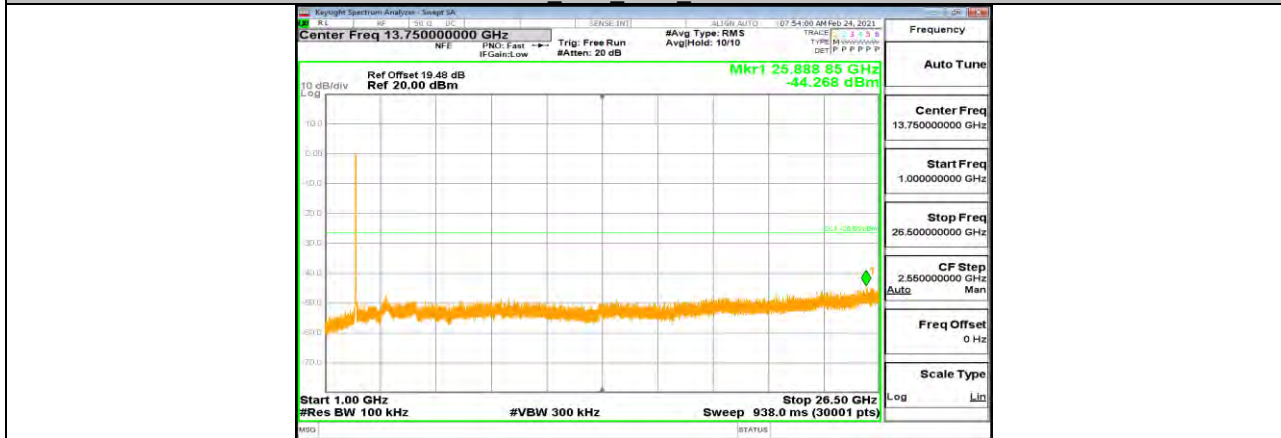

11G Ant1 2412 1000~26500



11G Ant2 2412 0-Reference

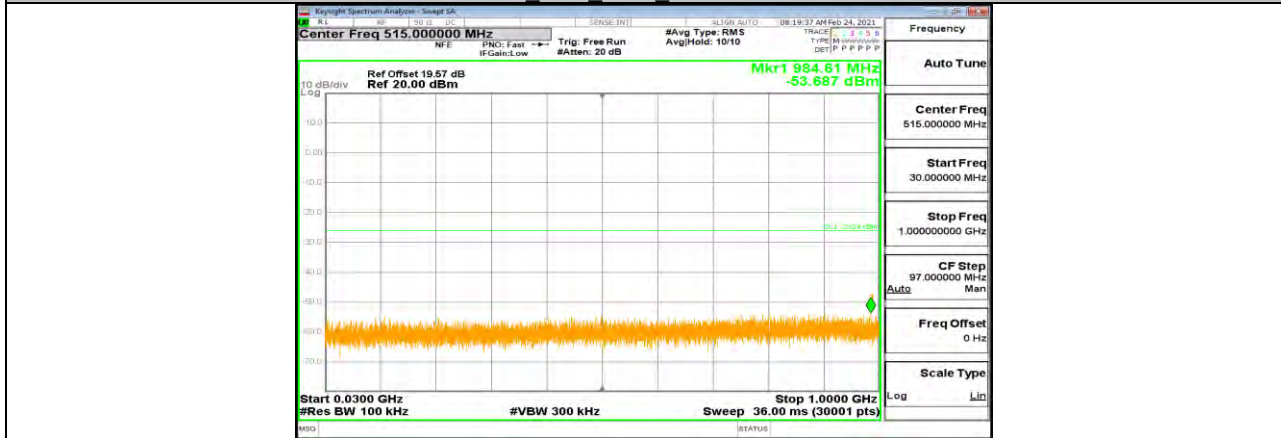

11G Ant2 2412 30~1000

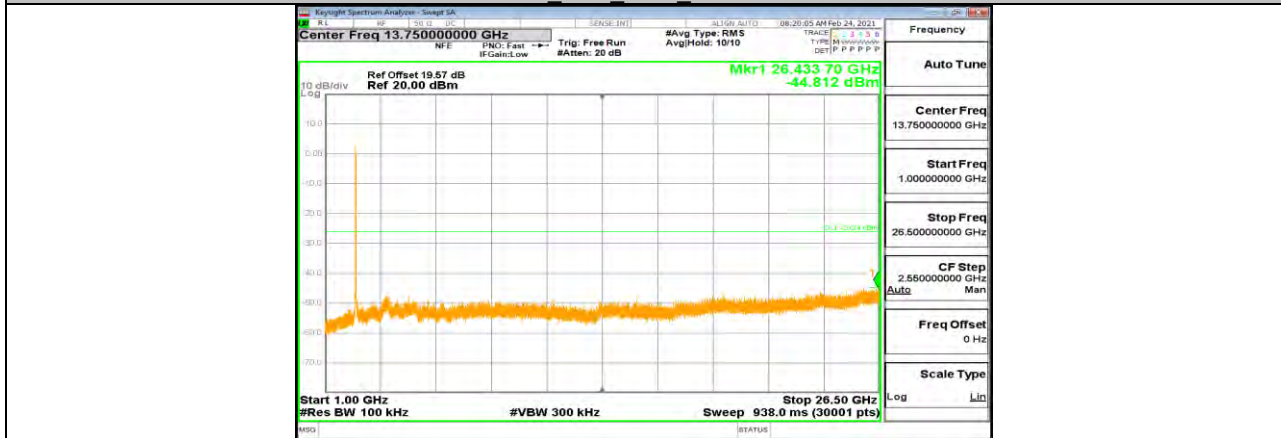

11G Ant2 2412 1000~26500



11G Ant1 2437 0-Reference

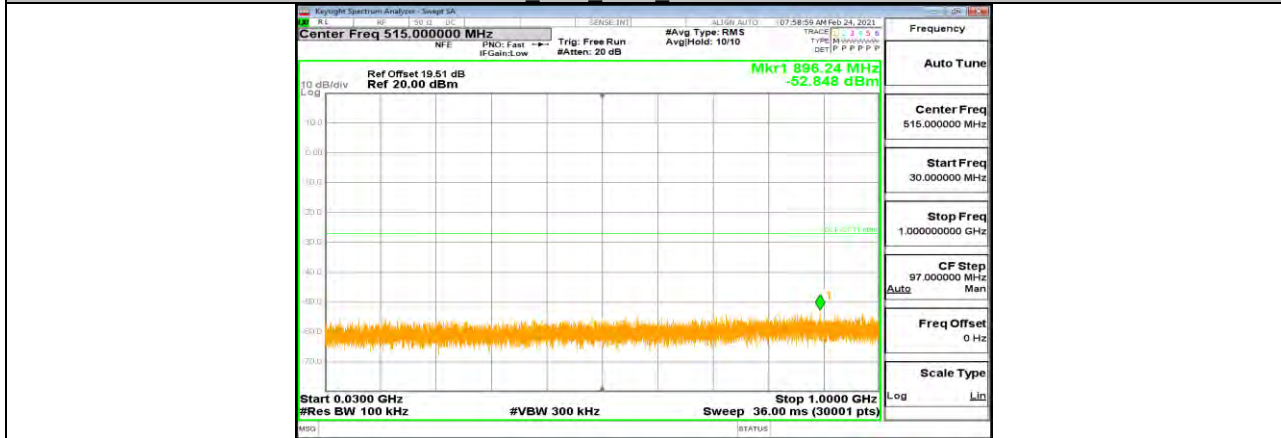

11G Ant1 2437 30~1000

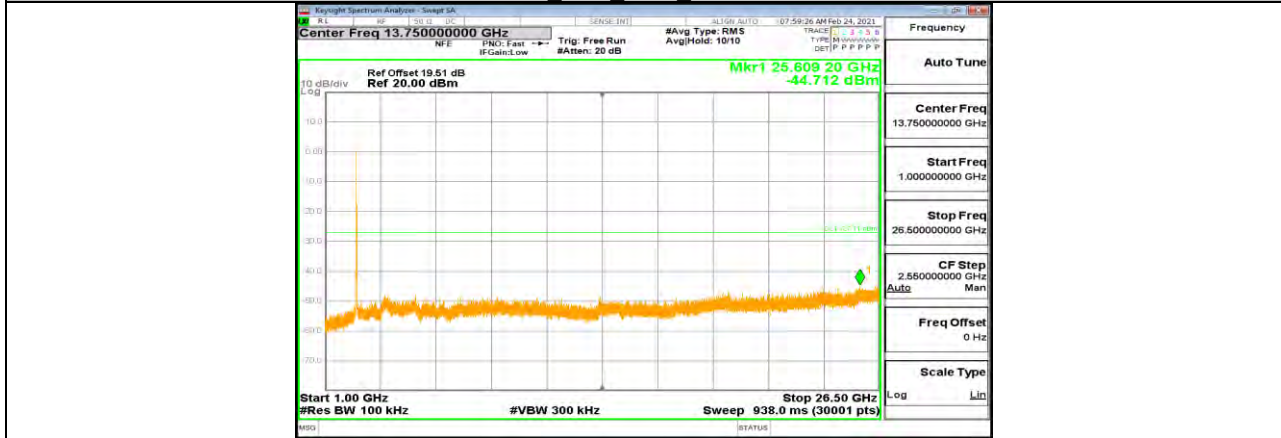

11G Ant1 2437 1000~26500



11G Ant2 2437 0-Reference

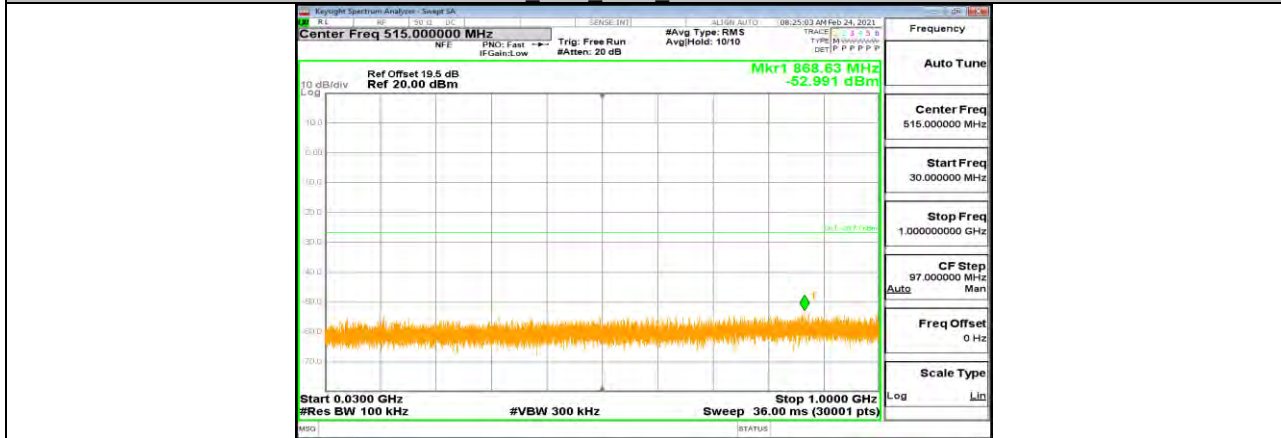

11G Ant2 2437 30~1000

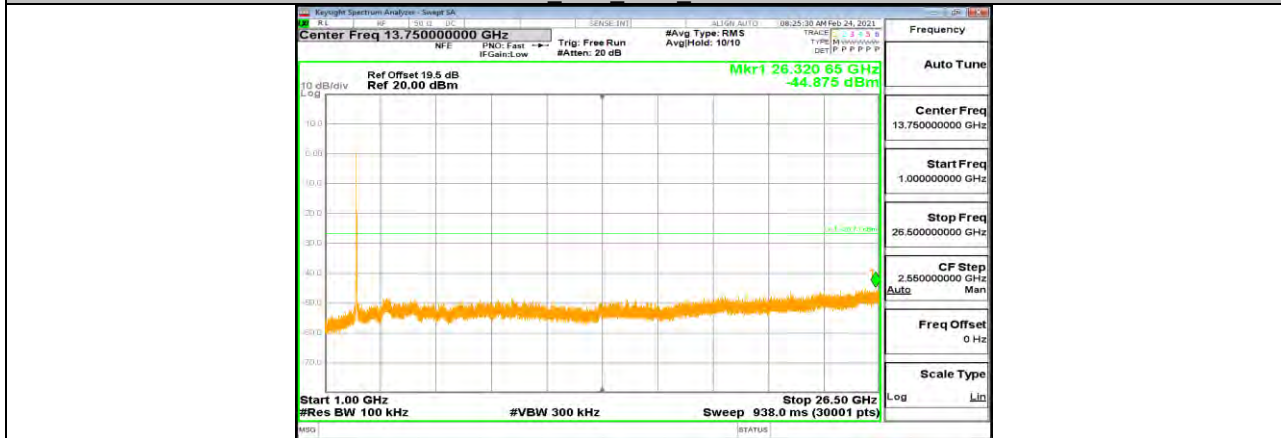

11G Ant2 2437 1000~26500



11G Ant1 2462 0-Reference

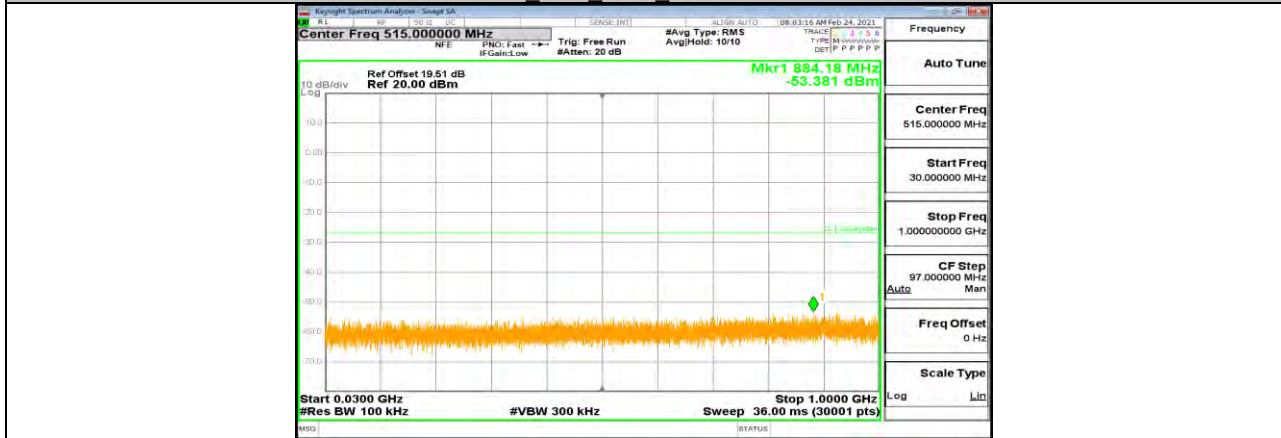

11G Ant1 2462 30~1000

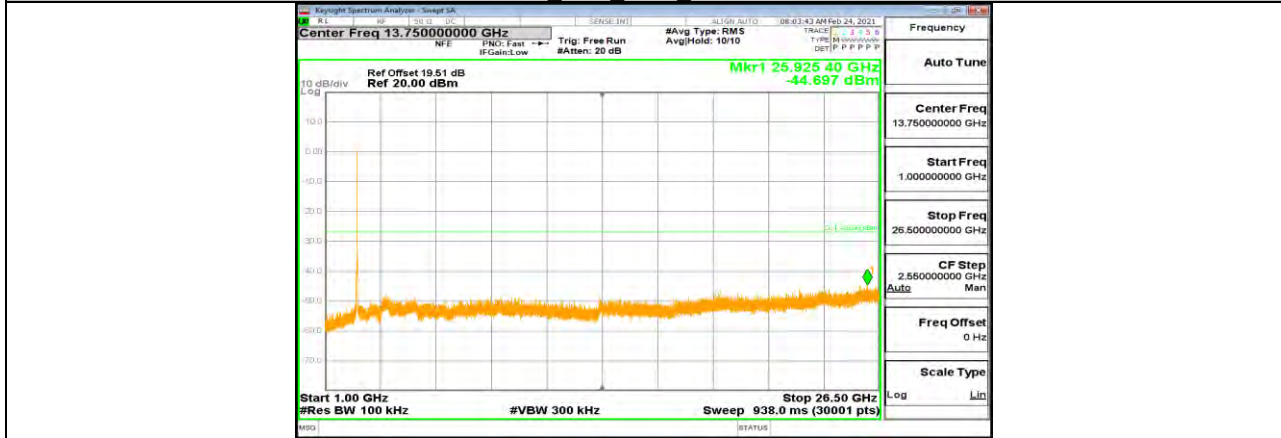

11G Ant1 2462 1000~26500



11G Ant2 2462 0-Reference

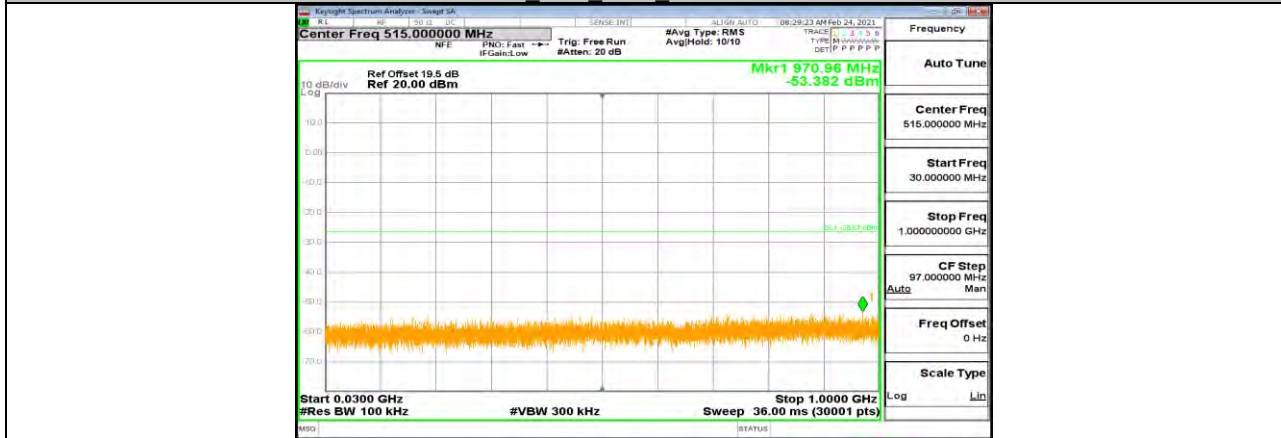

11G Ant2 2462 30~1000

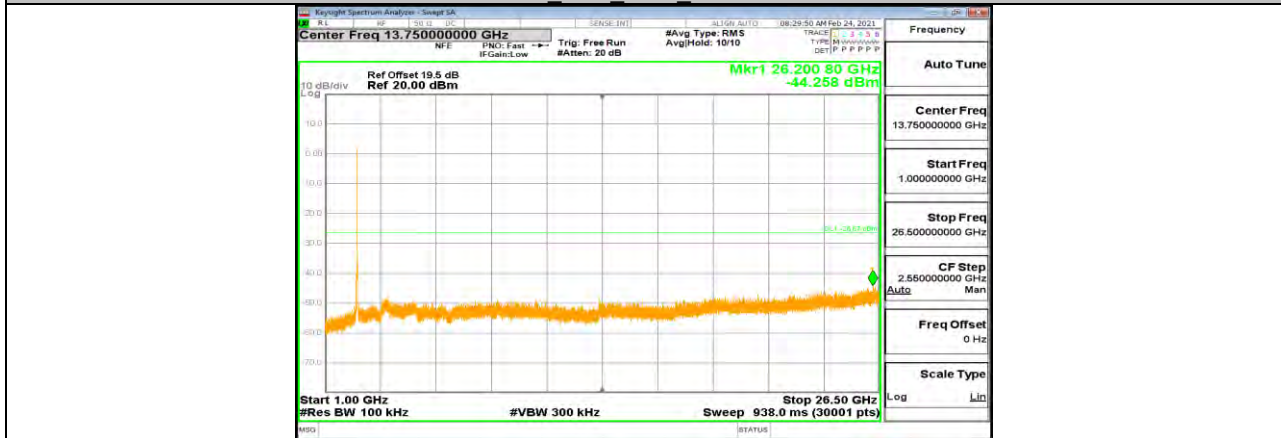

11G Ant2 2462 1000~26500



11N20MIMO Ant1 2412 0~Reference

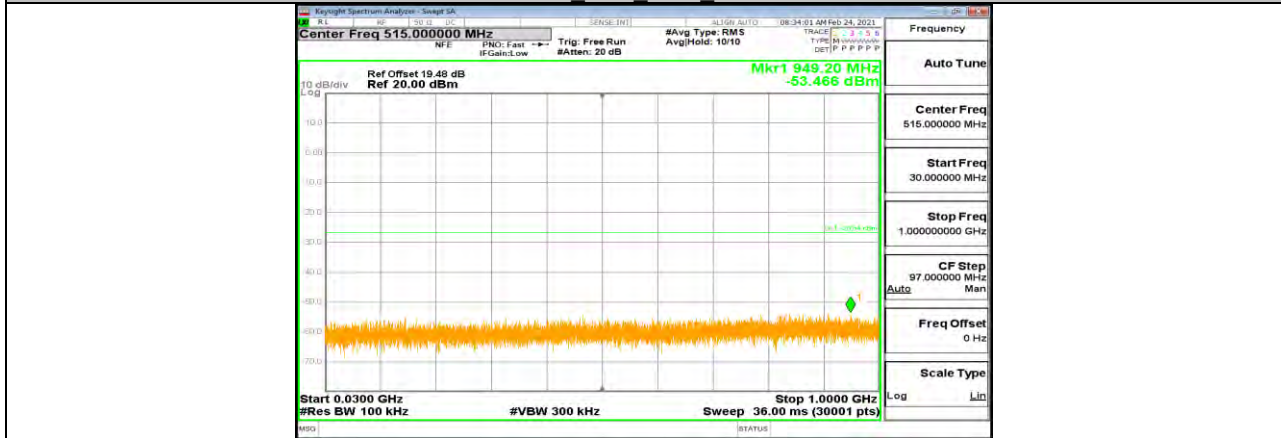

11N20MIMO Ant1 2412 30~1000

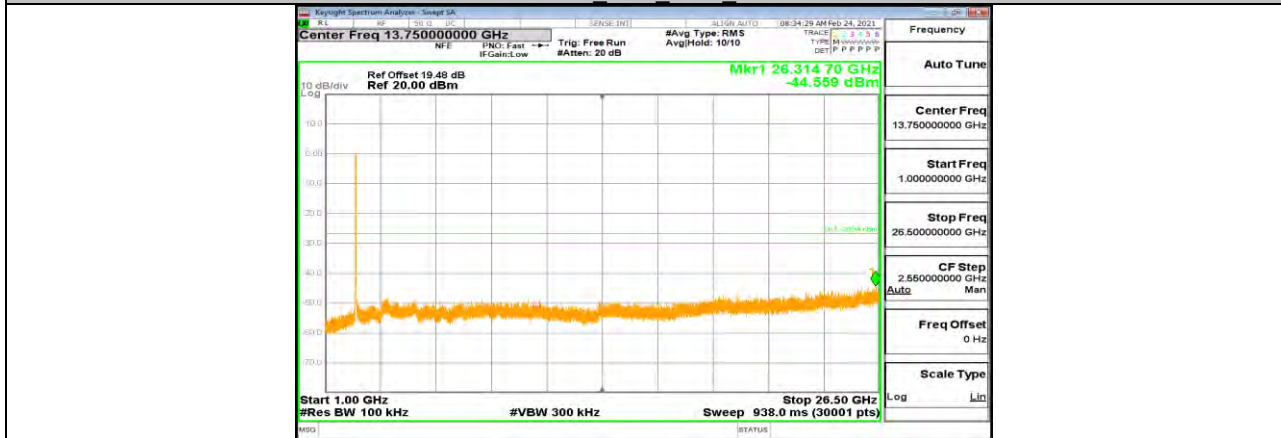

11N20MIMO Ant1 2412 1000~26500

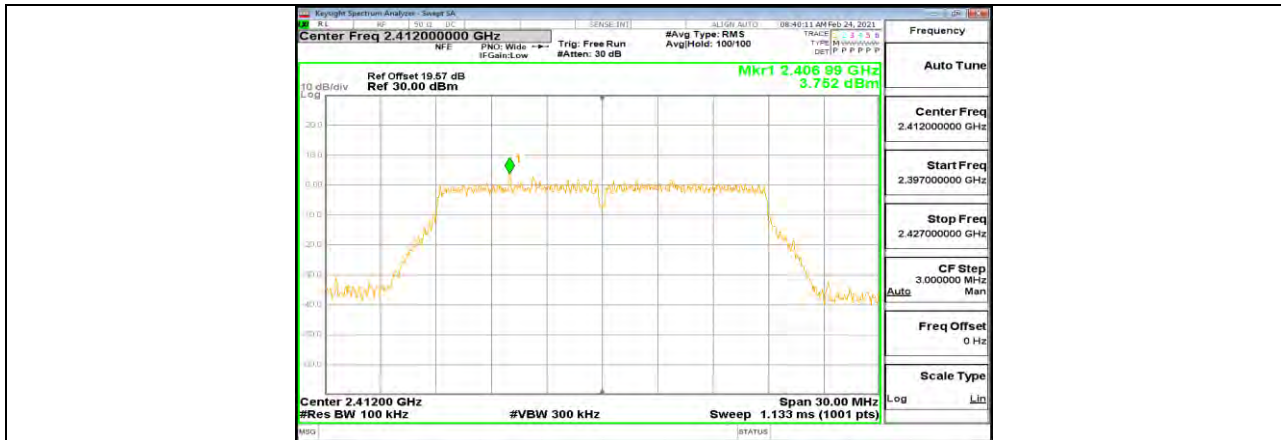

11N20MIMO Ant2 2412 0~Reference

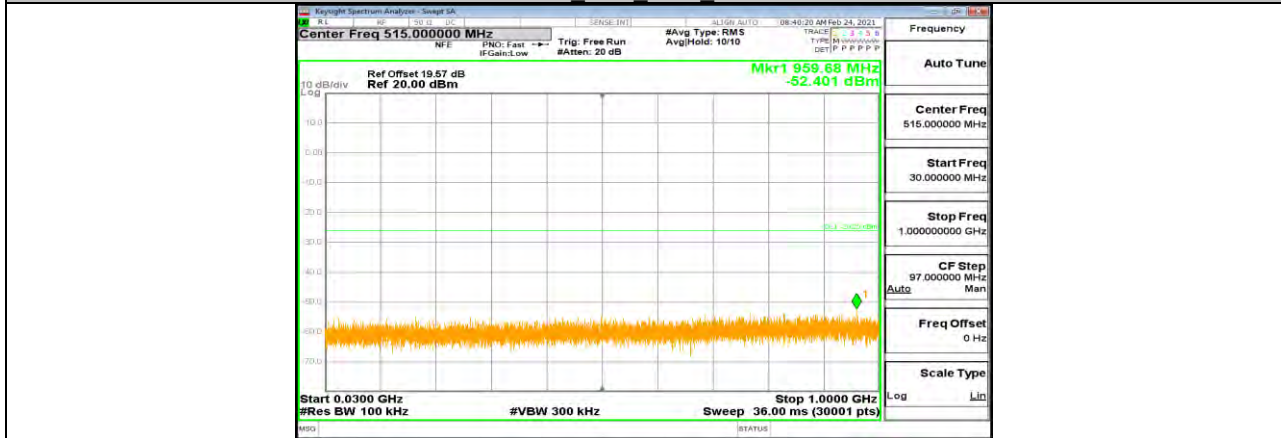

11N20MIMO Ant2 2412 30~1000

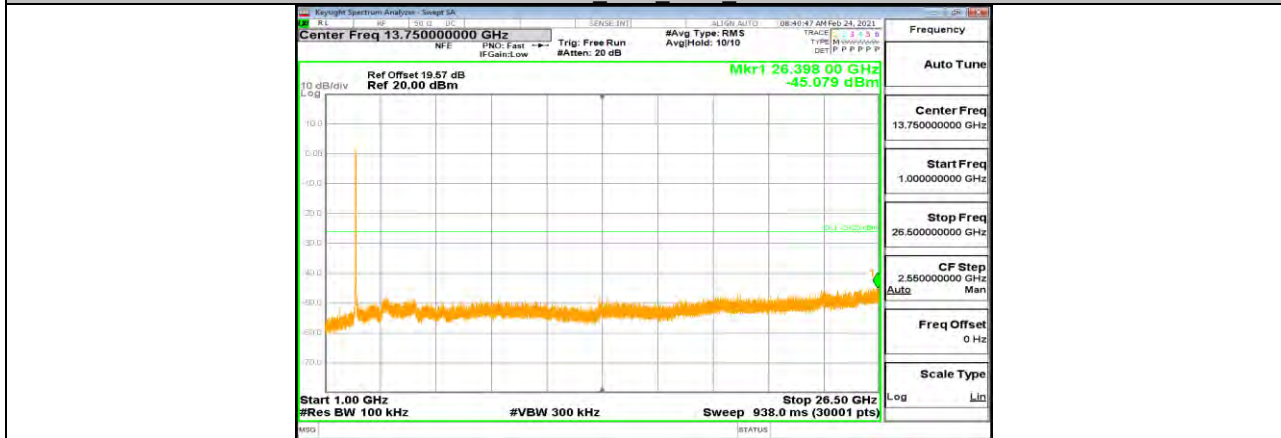

11N20MIMO Ant2 2412 1000~26500



11N20MIMO Ant1 2437 0~Reference

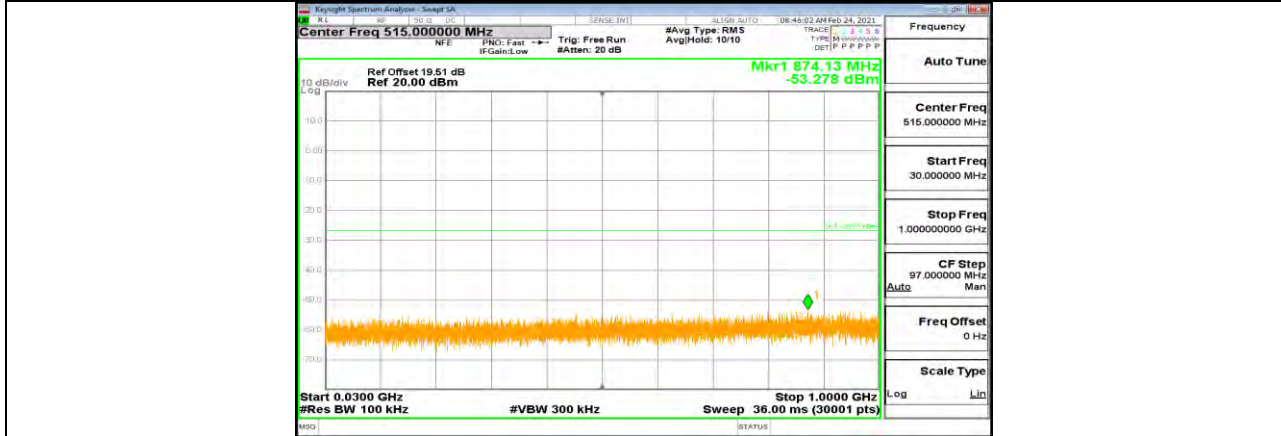

11N20MIMO Ant1 2437 30~1000

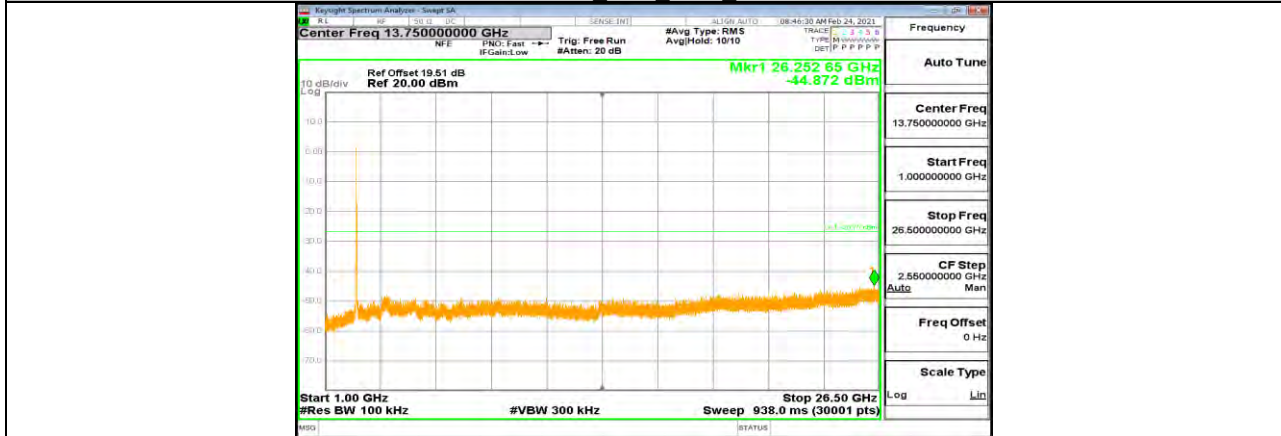

11N20MIMO Ant1 2437 1000~26500



11N20MIMO Ant2 2437 0~Reference

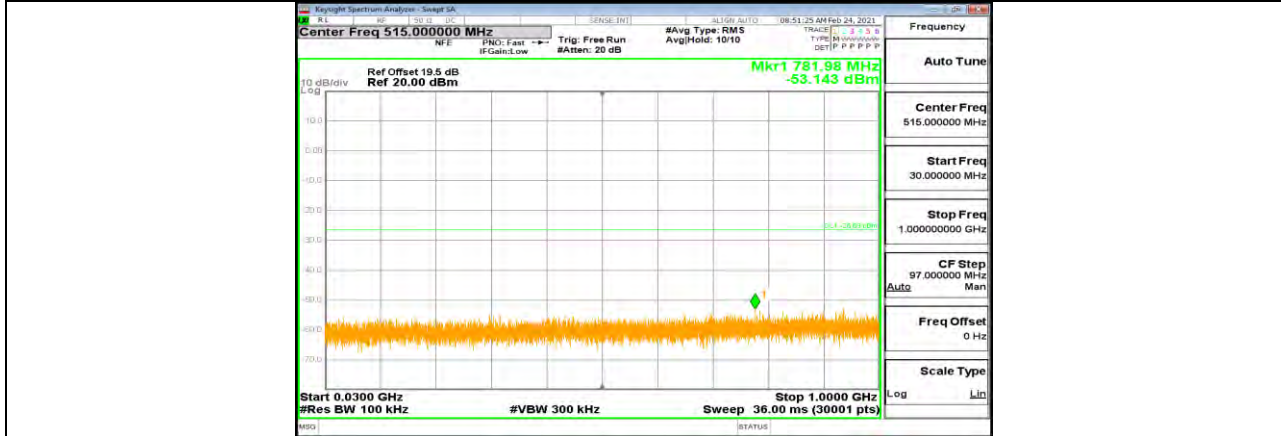

11N20MIMO Ant2 2437 30~1000

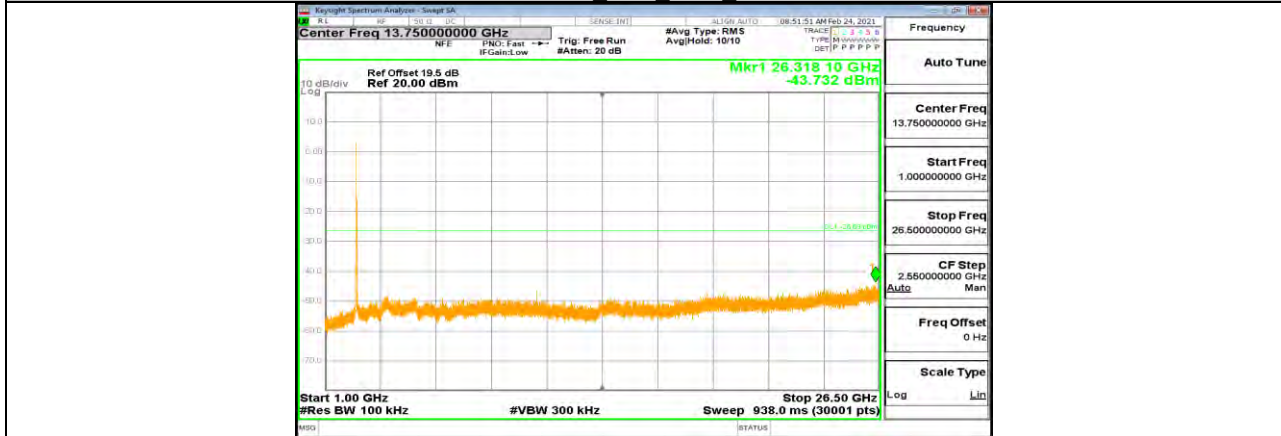

11N20MIMO Ant2 2437 1000~26500

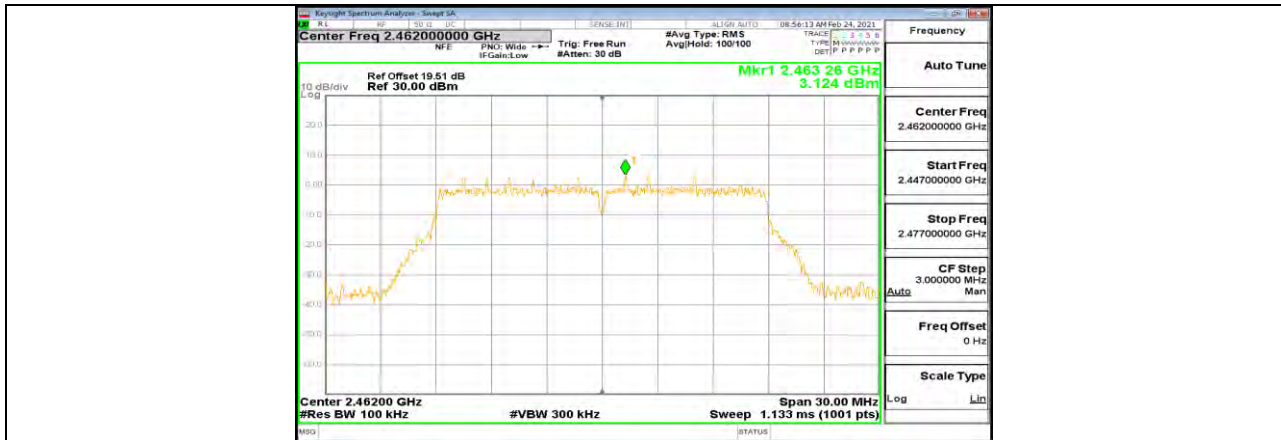

11N20MIMO Ant1 2462 0~Reference

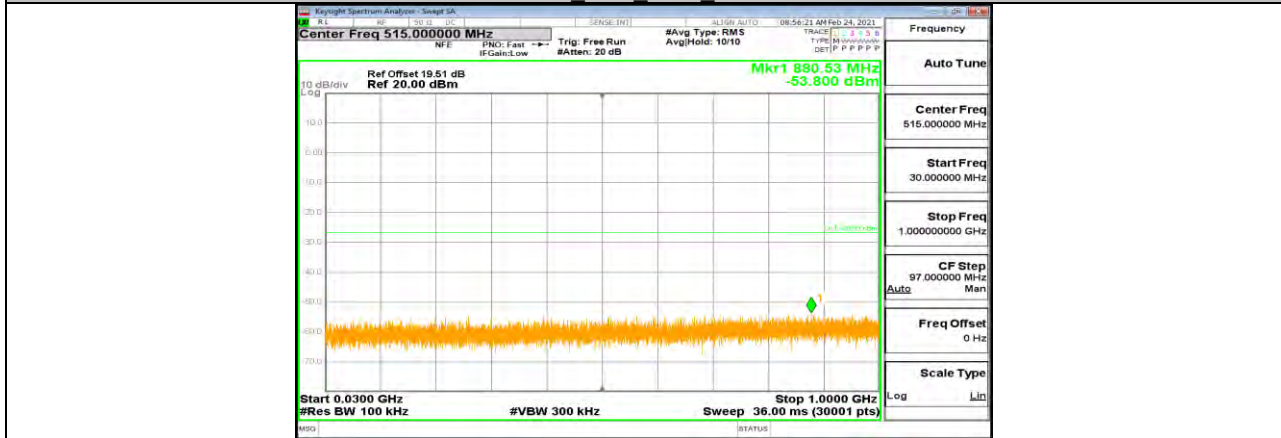

11N20MIMO Ant1 2462 30~1000

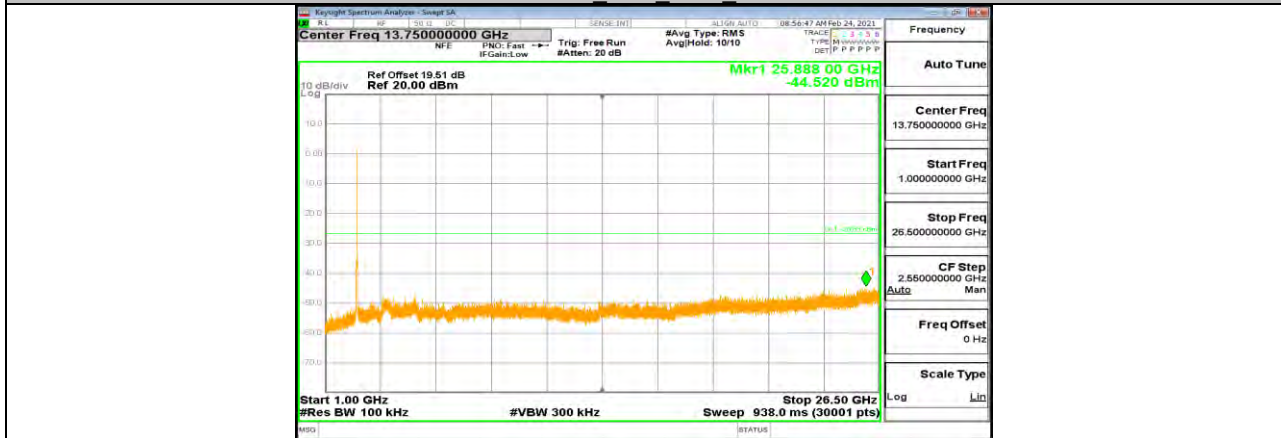

11N20MIMO Ant1 2462 1000~26500

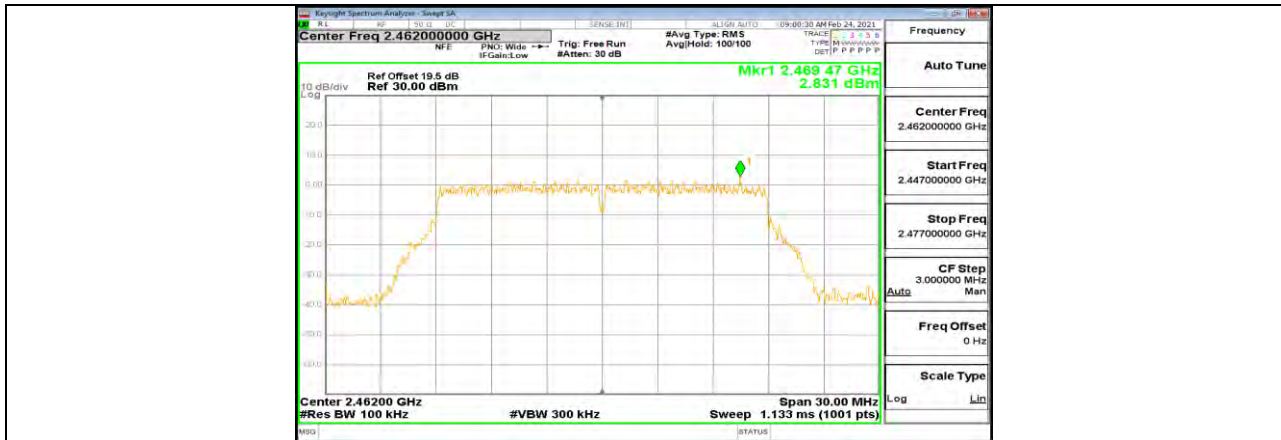

11N20MIMO Ant2 2462 0~Reference

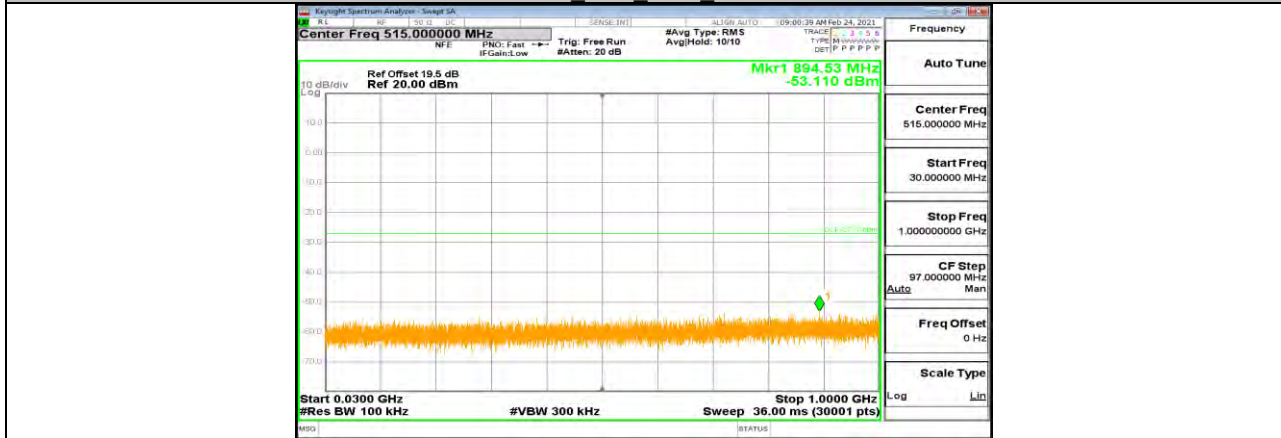

11N20MIMO Ant2 2462 30~1000

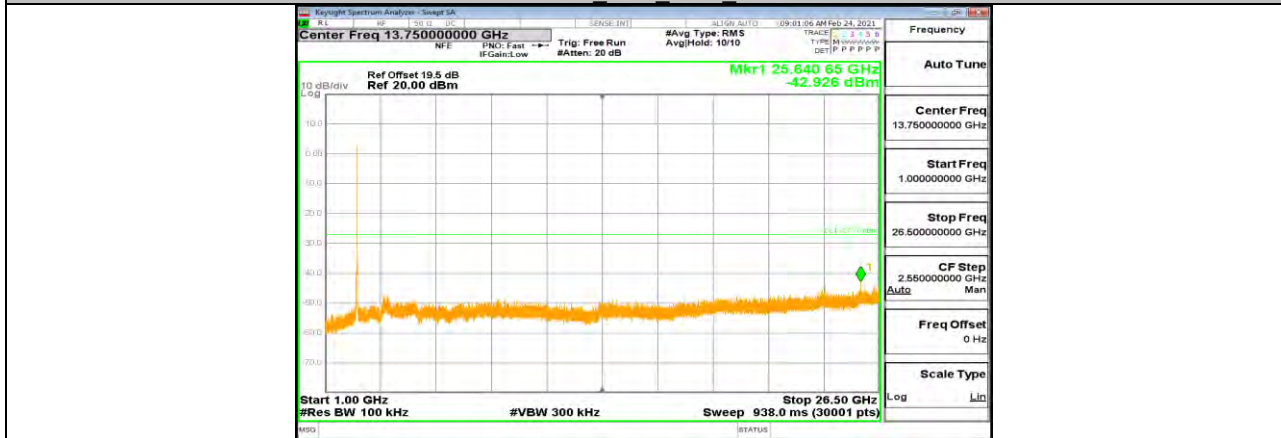

11N20MIMO Ant2 2462 1000~26500



11.7. Appendix G: Duty Cycle

11.7.1. Test Result

Mode	On Time (msec)	Period (msec)	Duty Cycle x (Linear)	Duty Cycle (%)	Duty Cycle Correction Factor (dB)	1/T Minimum VBW (kHz)	Final setting For VBW (kHz)
11B	8.41	8.45	0.9953	99.53	0.02	0.12	0.5
11G	1.39	1.44	0.9653	96.53	0.15	0.72	1
11N20MIMO	1.31	1.35	0.9704	97.04	0.13	0.76	1

Note:

Duty Cycle Correction Factor=10log (1/x).

Where: x is Duty Cycle (Linear)

Where: T is On Time

If that calculated VBW is not available on the analyzer then the next higher value should be used.



11.7.2. Test Graphs

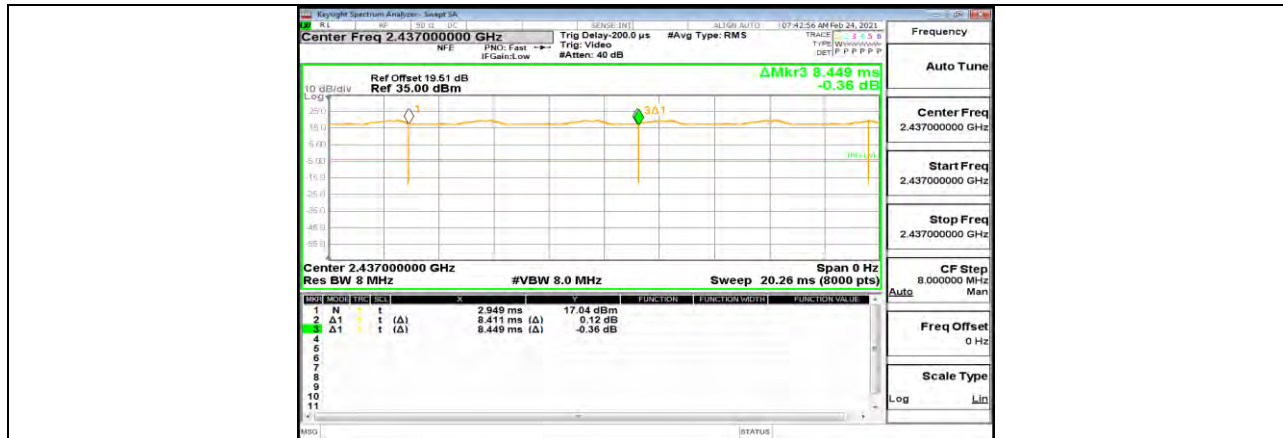

11B Ant1 2437



11G Ant1 2437



11N20MIMO Ant1 2437

END OF REPORT