



Add: No.52 HuaYuanBei Road, Haidian District, Beijing, 100191, China  
 Tel: +86-10-62304633-2117  
 E-mail: emf@caict.ac.cn      http://www.caict.ac.cn

### Measurement Conditions

DASY system configuration, as far as not given on page 1.

<b>DASY Version</b>	DASY52	52.10.4
<b>Extrapolation</b>	Advanced Extrapolation	
<b>Phantom</b>	Triple Flat Phantom 5.1C	
<b>Distance Dipole Center - TSL</b>	10 mm	with Spacer
<b>Zoom Scan Resolution</b>	dx, dy, dz = 5 mm	
<b>Frequency</b>	2300 MHz ± 1 MHz	

### Head TSL parameters

The following parameters and calculations were applied.

	Temperature	Permittivity	Conductivity
<b>Nominal Head TSL parameters</b>	22.0 °C	39.5	1.67 mho/m
<b>Measured Head TSL parameters</b>	(22.0 ± 0.2) °C	39.8 ± 6 %	1.68 mho/m ± 6 %
<b>Head TSL temperature change during test</b>	<1.0 °C	---	---

### SAR result with Head TSL

<b>SAR averaged over 1 cm<sup>3</sup> (1 g) of Head TSL</b>	Condition	
SAR measured	250 mW input power	12.4 W/kg
SAR for nominal Head TSL parameters	normalized to 1W	<b>49.6 W/kg ± 18.8 % (k=2)</b>
<b>SAR averaged over 10 cm<sup>3</sup> (10 g) of Head TSL</b>	Condition	
SAR measured	250 mW input power	5.99 W/kg
SAR for nominal Head TSL parameters	normalized to 1W	<b>24.0 W/kg ± 18.7 % (k=2)</b>



Add: No.52 HuaYuanBei Road, Haidian District, Beijing, 100191, China  
Tel: +86-10-62304633-2117  
E-mail: emf@caict.ac.cn      <http://www.caict.ac.cn>

## Appendix (Additional assessments outside the scope of CNAS L0570)

### Antenna Parameters with Head TSL

Impedance, transformed to feed point	47.4Ω- 4.32jΩ
Return Loss	- 25.8dB

### General Antenna Parameters and Design

Electrical Delay (one direction)	1.083 ns
----------------------------------	----------

After long term use with 100W radiated power, only a slight warming of the dipole near the feed-point can be measured.

The dipole is made of standard semirigid coaxial cable. The center conductor of the feeding line is directly connected to the second arm of the dipole. The antenna is therefore short-circuited for DC-signals. On some of the dipoles, small end caps are added to the dipole arms in order to improve matching when loaded according to the position as explained in the "Measurement Conditions" paragraph. The SAR data are not affected by this change. The overall dipole length is still according to the Standard.

No excessive force must be applied to the dipole arms, because they might bend or the soldered connections near the feed-point may be damaged.

### Additional EUT Data

Manufactured by	SPEAG
-----------------	-------

Add: No.52 HuaYuanBei Road, Haidian District, Beijing, 100191, China  
Tel: +86-10-62304633-2117  
E-mail: emf@caict.ac.cn      http://www.caict.ac.cn

### DASY5 Validation Report for Head TSL

Date: 2024-06-16

Test Laboratory: CTTL, Beijing, China

**DUT: Dipole 2300 MHz; Type: D2300V2; Serial: D2300V2 - SN: 1053**

Communication System: UID 0, CW; Frequency: 2300 MHz

Medium parameters used:  $f = 2300$  MHz;  $\sigma = 1.678$  S/m;  $\epsilon_r = 39.82$ ;  $\rho = 1000$  kg/m<sup>3</sup>

Phantom section: Right Section

Measurement Standard: DASY5 (IEEE/IEC/ANSI C63.19-2007)

#### DASY5 Configuration:

- Probe: EX3DV4 - SN7307; ConvF(7.65, 7.63, 8.26) @ 2300 MHz; Calibrated: 2024-05-28
- Sensor-Surface: 1.4mm (Mechanical Surface Detection)
- Electronics: DAE4 Sn1556; Calibrated: 2024-01-03
- Phantom: MFP\_V5.1C (20deg probe tilt); Type: QD 000 P51 Cx; Serial: 1062
- DASY52 52.10.4(1535); SEMCAD X 14.6.14(7501)

**Dipole Calibration/Zoom Scan (7x7x7) (7x7x7)/Cube 0:** Measurement grid: dx=5mm, dy=5mm, dz=5mm

Reference Value = 103.0 V/m; Power Drift = -0.02 dB

Peak SAR (extrapolated) = 23.6 W/kg

**SAR(1 g) = 12.4 W/kg; SAR(10 g) = 5.99 W/kg**

Smallest distance from peaks to all points 3 dB below = 9 mm

Ratio of SAR at M2 to SAR at M1 = 53.6%

Maximum value of SAR (measured) = 19.9 W/kg

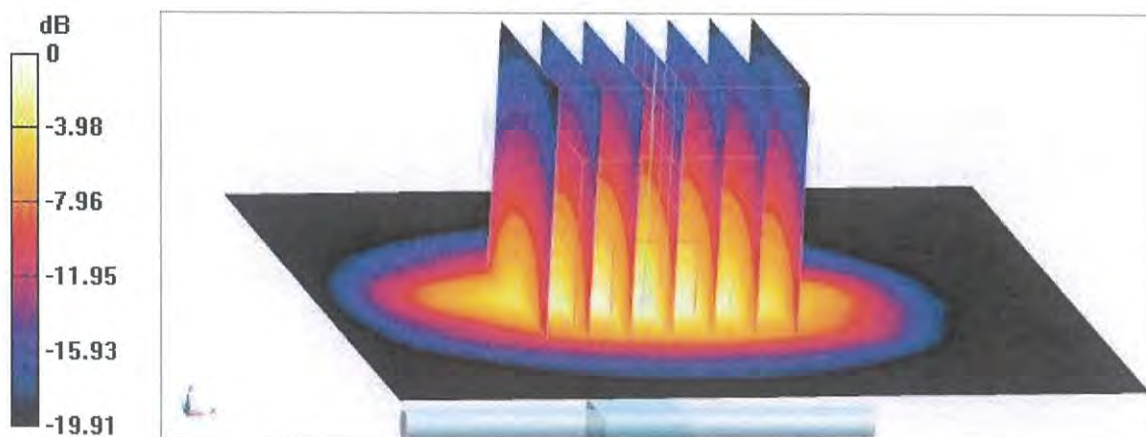

0 dB = 19.9 W/kg = 12.99 dBW/kg



Add: No.52 HuaYuanBei Road, Haidian District, Beijing, 100191, China  
Tel: +86-10-62304633-2117  
E-mail: emf@caict.ac.cn      http://www.caict.ac.cn

### Impedance Measurement Plot for Head TSL

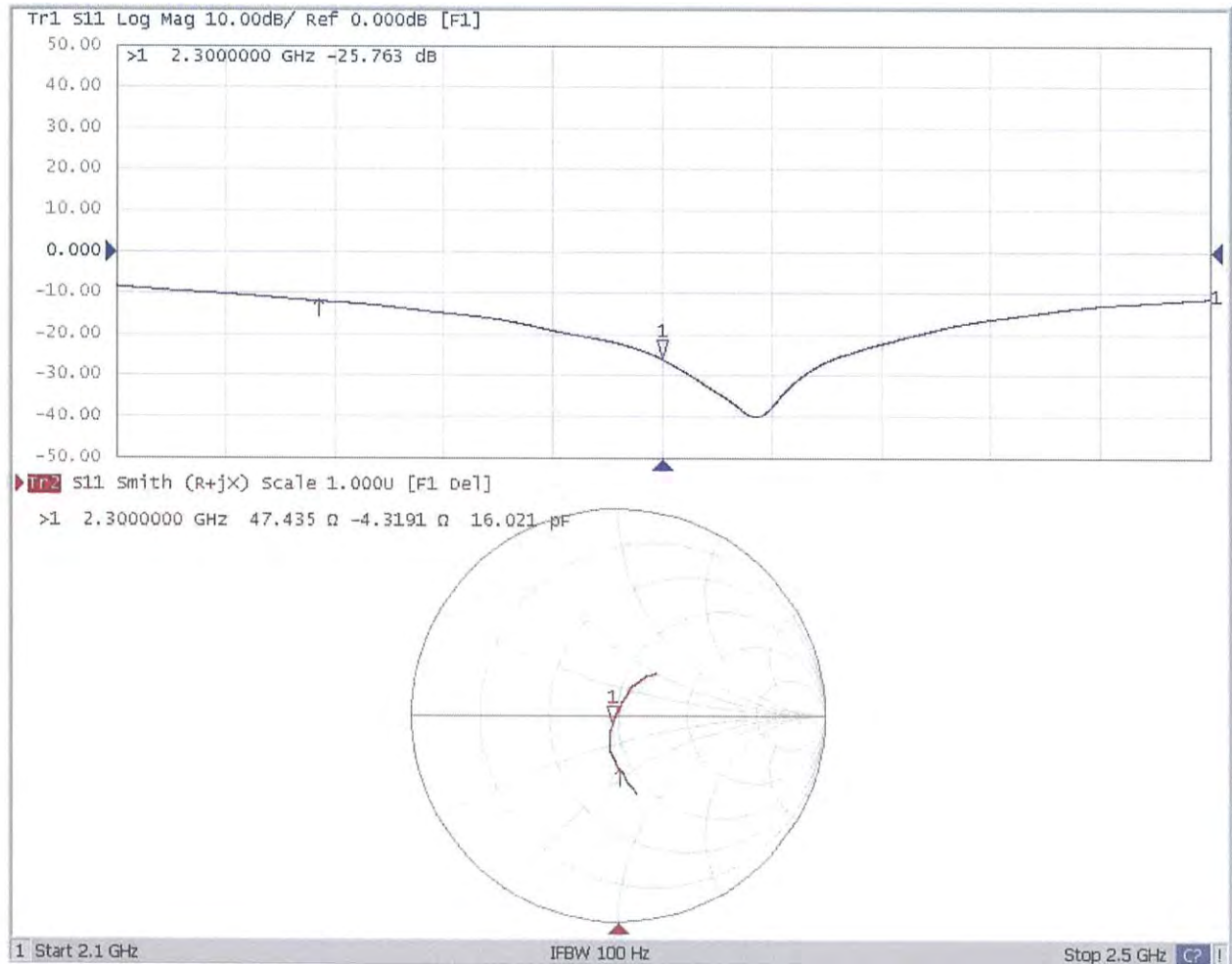

Add: No.52 HuaYuanBei Road, Haidian District, Beijing, 100191  
Tel: +86-10-62304633-2117  
E-mail: cttl@chinattl.com      http://www.caict.ac.cn

Client **B.V.ADT**

Certificate No: **24J02Z000329**

## CALIBRATION CERTIFICATE

Object **D2450V2 - SN: 893**

Calibration Procedure(s) **FF-Z11-003-01**  
**Calibration Procedures for dipole validation kits**

Calibration date: **June 15, 2024**

This calibration Certificate documents the traceability to national standards, which realize the physical units of measurements (SI). The measurements and the uncertainties with confidence probability are given on the following pages and are part of the certificate.

All calibrations have been conducted in the closed laboratory facility: environment temperature (22±3)°C and humidity<70%.

Calibration Equipment used (M&TE critical for calibration)

Primary Standards	ID #	Cal Date (Calibrated by, Certificate No.)	Scheduled Calibration
Power Meter NRP2	106276	17-May-24 (CTTL, No. J24X04107)	May-25
Power sensor NRP6A	101369	17-May-24 (CTTL, No. J24X04107)	May-25
Reference Probe EX3DV4	SN 7307	28-May-24(SPEAG, No. EX-7307_May24)	May-25
DAE4	SN 1556	03-Jan-24(CTTL-SPEAG, No.24J02Z80002)	Jan-25
Secondary Standards	ID #	Cal Date (Calibrated by, Certificate No.)	Scheduled Calibration
Signal Generator E4438C	MY49071430	25-Dec-23 (CTTL, No. J23X13426)	Dec-24
NetworkAnalyzer E5071C	MY46110673	25-Dec-23 (CTTL, No. J23X13425)	Dec-24
OCP DAK-3.5(weighted)	1040	22-Jan-24(SPEAG, No.OCP-DAK3.5-1040_Jan24)	Jan-25

	Name	Function	Signature
Calibrated by:	Zhao Jing	SAR Test Engineer	
Reviewed by:	Lin Jun	SAR Test Engineer	
Approved by:	Qi Dianyuan	SAR Project Leader	

Issued: June 22, 2024

This calibration certificate shall not be reproduced except in full without written approval of the laboratory.



Add: No.52 HuaYuanBei Road, Haidian District, Beijing, 100191, China  
Tel: +86-10-62304633-2117  
E-mail: cttl@chinattl.com      <http://www.caict.ac.cn>

### Glossary:

TSL	tissue simulating liquid
ConvF	sensitivity in TSL / NORM <sub>x,y,z</sub>
N/A	not applicable or not measured

### Calibration is Performed According to the Following Standards:

- a) IEC/IEEE 62209-1528, "Measurement Procedure for The Assessment of Specific Absorption Rate of Human Exposure to Radio Frequency Fields from Hand-held and Body-mounted Wireless Communication Devices- Part 1528: Human Models, Instrumentation and Procedures (Frequency range of 4 MHz to 10 GHz)", October 2020
- b) KDB 865664, "SAR Measurement Requirements for 100 MHz to 6 GHz"

### Additional Documentation:

- c) DAS4/5 System Handbook

### Methods Applied and Interpretation of Parameters:

- *Measurement Conditions:* Further details are available from the Validation Report at the end of the certificate. All figures stated in the certificate are valid at the frequency indicated.
- *Antenna Parameters with TSL:* The dipole is mounted with the spacer to position its feed point exactly below the center marking of the flat phantom section, with the arms oriented parallel to the body axis.
- *Feed Point Impedance and Return Loss:* These parameters are measured with the dipole positioned under the liquid filled phantom. The impedance stated is transformed from the measurement at the SMA connector to the feed point. The Return Loss ensures low reflected power. No uncertainty required.
- *Electrical Delay:* One-way delay between the SMA connector and the antenna feed point. No uncertainty required.
- *SAR measured:* SAR measured at the stated antenna input power.
- *SAR normalized:* SAR as measured, normalized to an input power of 1 W at the antenna connector.
- *SAR for nominal TSL parameters:* The measured TSL parameters are used to calculate the nominal SAR result.

The reported uncertainty of measurement is stated as the standard uncertainty of Measurement multiplied by the coverage factor  $k=2$ , which for a normal distribution Corresponds to a coverage probability of approximately 95%.



Add: No.52 HuaYuanBei Road, Haidian District, Beijing, 100191, China  
Tel: +86-10-62304633-2117  
E-mail: cttl@chinattl.com      <http://www.caict.ac.cn>

### Measurement Conditions

DASY system configuration, as far as not given on page 1.

<b>DASY Version</b>	DASY52	52.10.4
<b>Extrapolation</b>	Advanced Extrapolation	
<b>Phantom</b>	Triple Flat Phantom 5.1C	
<b>Distance Dipole Center - TSL</b>	10 mm	with Spacer
<b>Zoom Scan Resolution</b>	dx, dy, dz = 5 mm	
<b>Frequency</b>	2450 MHz ± 1 MHz	

### Head TSL parameters

The following parameters and calculations were applied.

	Temperature	Permittivity	Conductivity
<b>Nominal Head TSL parameters</b>	22.0 °C	39.2	1.80 mho/m
<b>Measured Head TSL parameters</b>	(22.0 ± 0.2) °C	39.1 ± 6 %	1.80 mho/m ± 6 %
<b>Head TSL temperature change during test</b>	<1.0 °C	----	----

### SAR result with Head TSL

<b>SAR averaged over 1 cm<sup>3</sup> (1 g) of Head TSL</b>	Condition	
SAR measured	250 mW input power	13.3 W/kg
SAR for nominal Head TSL parameters	normalized to 1W	<b>53.1 W/kg ± 18.8 % (k=2)</b>
<b>SAR averaged over 10 cm<sup>3</sup> (10 g) of Head TSL</b>	Condition	
SAR measured	250 mW input power	6.23 W/kg
SAR for nominal Head TSL parameters	normalized to 1W	<b>24.9 W/kg ± 18.7 % (k=2)</b>



Add: No.52 HuaYuanBei Road, Haidian District, Beijing, 100191, China  
 Tel: +86-10-62304633-2117  
 E-mail: cttl@chinattl.com      <http://www.caict.ac.cn>

## Appendix (Additional assessments outside the scope of CNAS L0570)

### Antenna Parameters with Head TSL

Impedance, transformed to feed point	52.1Ω+ 7.70jΩ
Return Loss	- 22.2dB

### General Antenna Parameters and Design

Electrical Delay (one direction)	1.069 ns
----------------------------------	----------

After long term use with 100W radiated power, only a slight warming of the dipole near the feed-point can be measured.

The dipole is made of standard semirigid coaxial cable. The center conductor of the feeding line is directly connected to the second arm of the dipole. The antenna is therefore short-circuited for DC-signals. On some of the dipoles, small end caps are added to the dipole arms in order to improve matching when loaded according to the position as explained in the "Measurement Conditions" paragraph. The SAR data are not affected by this change. The overall dipole length is still according to the Standard.

No excessive force must be applied to the dipole arms, because they might bend or the soldered connections near the feed-point may be damaged.

### Additional EUT Data

Manufactured by	SPEAG
-----------------	-------



Add: No.52 HuaYuanBei Road, Haidian District, Beijing, 100191, China  
Tel: +86-10-62304633-2117  
E-mail: cttl@chinattl.com      http://www.caict.ac.cn

**DASY5 Validation Report for Head TSL**

Date: 2024-06-15

Test Laboratory: CTTL, Beijing, China

**DUT: Dipole 2450 MHz; Type: D2450V2; Serial: D2450V2 - SN: 893**

Communication System: UID 0, CW; Frequency: 2450 MHz

Medium parameters used:  $f = 2450$  MHz;  $\sigma = 1.804$  S/m;  $\epsilon_r = 39.05$ ;  $\rho = 1000$  kg/m<sup>3</sup>

Phantom section: Right Section

Measurement Standard: DASY5 (IEEE/IEC/ANSI C63.19-2007)

**DASY5 Configuration:**

- Probe: EX3DV4 - SN7307; ConvF(7.37, 7.34, 7.95) @ 2450 MHz; Calibrated: 2024-05-28
- Sensor-Surface: 1.4mm (Mechanical Surface Detection)
- Electronics: DAE4 Sn1556; Calibrated: 2024-01-03
- Phantom: MFP\_V5.1C (20deg probe tilt); Type: QD 000 P51 Cx; Serial: 1062
- DASY52 52.10.4(1535); SEMCAD X 14.6.14(7501)

**Dipole Calibration/Zoom Scan (7x7x7) (7x7x7)/Cube 0:** Measurement grid: dx=5mm, dy=5mm, dz=5mm

Reference Value = 101.1 V/m; Power Drift = -0.03 dB

Peak SAR (extrapolated) = 25.9 W/kg

**SAR(1 g) = 13.3 W/kg; SAR(10 g) = 6.23 W/kg**

Smallest distance from peaks to all points 3 dB below = 8.9 mm

Ratio of SAR at M2 to SAR at M1 = 52%

Maximum value of SAR (measured) = 21.5 W/kg

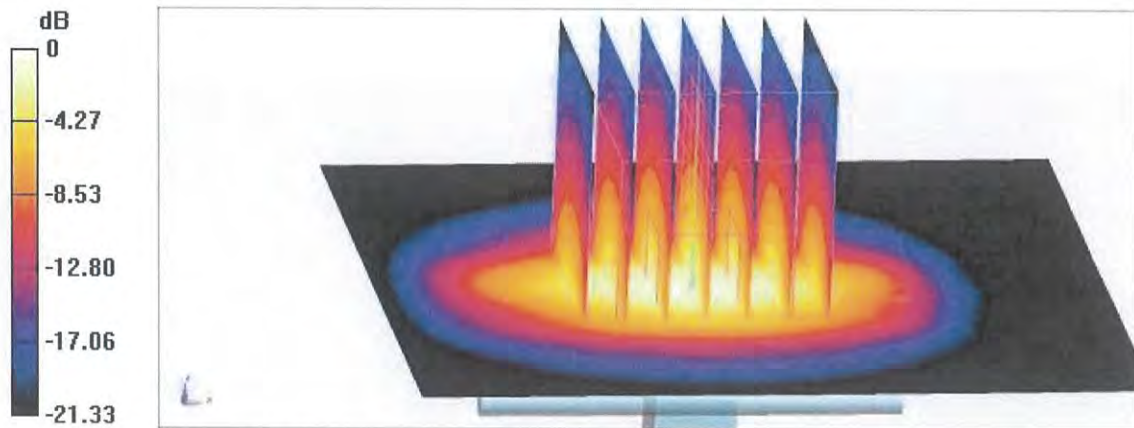

0 dB = 21.5 W/kg = 13.32 dBW/kg



Add: No.52 HuaYuanBei Road, Haidian District, Beijing, 100191, China  
Tel: +86-10-62304633-2117  
E-mail: cttl@chinattl.com      http://www.caict.ac.cn

### Impedance Measurement Plot for Head TSL

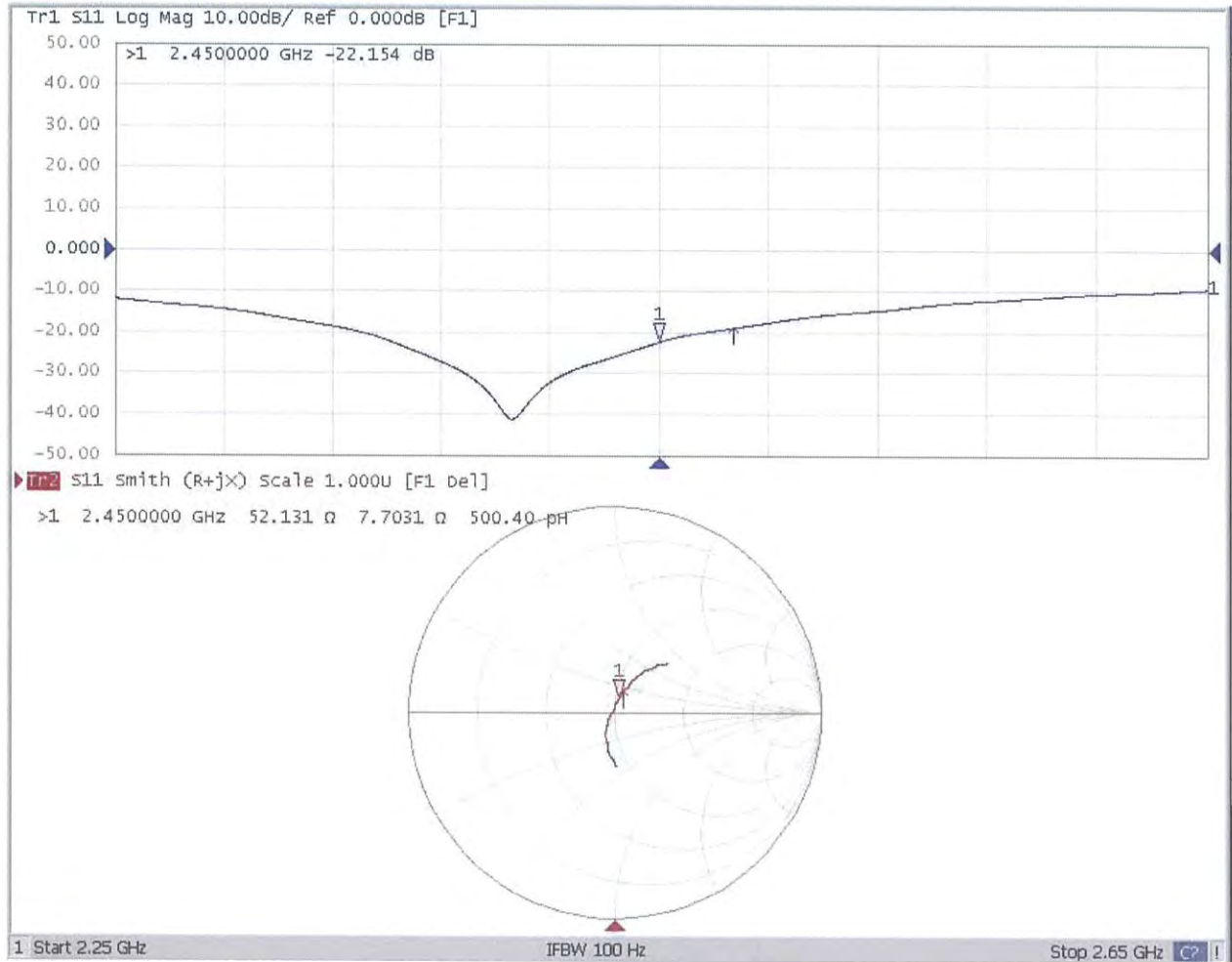

Add: No.52 HuaYuanBei Road, Haidian District, Beijing, 100191  
Tel: +86-10-62304633-2117  
E-mail: emf@caict.ac.cn      http://www.caict.ac.cn

**Client:** B.V.ADT

**Certificate No:** 24J02Z000330

## CALIBRATION CERTIFICATE

**Object** D2600V2 - SN: 1110

**Calibration Procedure(s)** FF-Z11-003-01  
Calibration Procedures for dipole validation kits



**Calibration date:** June 17, 2024

This calibration Certificate documents the traceability to national standards, which realize the physical units of measurements (SI). The measurements and the uncertainties with confidence probability are given on the following pages and are part of the certificate.

All calibrations have been conducted in the closed laboratory facility: environment temperature (22±3)°C and humidity<70%.

Calibration Equipment used (M&TE critical for calibration)

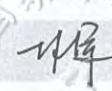
Primary Standards	ID #	Cal Date (Calibrated by, Certificate No.)	Scheduled Calibration
Power Meter NRP2	106276	17-May-24 (CTTL, No. J24X04107)	May-25
Power sensor NRP6A	101369	17-May-24 (CTTL, No. J24X04107)	May-25
Reference Probe EX3DV4	SN 7307	28-May-24(SPEAG, No. EX-7307_May24)	May-25
DAE4	SN 1556	03-Jan-24(CTTL-SPEAG, No.24J02Z80002)	Jan-25
Secondary Standards	ID #	Cal Date (Calibrated by, Certificate No.)	Scheduled Calibration
Signal Generator E4438C	MY49071430	25-Dec-23 (CTTL, No. J23X13426)	Dec-24
NetworkAnalyzer E5071C	MY46110673	25-Dec-23 (CTTL, No. J23X13425)	Dec-24
OCP DAK-3.5(weighted)	1040	22-Jan-24(SPEAG, No.OCP-DAK3.5-1040_Jan24)	Jan-25

	Name	Function	Signature
Calibrated by:	Zhao Jing	SAR Test Engineer	
Reviewed by:	Lin Jun	SAR Test Engineer	
Approved by:	Qi Dianyuan	SAR Project Leader	

Issued: June 22, 2024

This calibration certificate shall not be reproduced except in full without written approval of the laboratory.



Add: No.52 HuaYuanBei Road, Haidian District, Beijing, 100191, China

Tel: +86-10-62304633-2117

E-mail: emf@caict.ac.cn

http://www.caict.ac.cn

### Glossary:

TSL	tissue simulating liquid
ConvF	sensitivity in TSL / NORM <sub>x,y,z</sub>
N/A	not applicable or not measured

### Calibration is Performed According to the Following Standards:

- IEC/IEEE 62209-1528, "Measurement Procedure for The Assessment of Specific Absorption Rate of Human Exposure to Radio Frequency Fields from Hand-held and Body-mounted Wireless Communication Devices- Part 1528: Human Models, Instrumentation and Procedures (Frequency range of 4 MHz to 10 GHz)", October 2020
- KDB 865664, "SAR Measurement Requirements for 100 MHz to 6 GHz"

### Additional Documentation:

- DASY4/5 System Handbook

### Methods Applied and Interpretation of Parameters:

- Measurement Conditions:** Further details are available from the Validation Report at the end of the certificate. All figures stated in the certificate are valid at the frequency indicated.
- Antenna Parameters with TSL:** The dipole is mounted with the spacer to position its feed point exactly below the center marking of the flat phantom section, with the arms oriented parallel to the body axis.
- Feed Point Impedance and Return Loss:** These parameters are measured with the dipole positioned under the liquid filled phantom. The impedance stated is transformed from the measurement at the SMA connector to the feed point. The Return Loss ensures low reflected power. No uncertainty required.
- Electrical Delay:** One-way delay between the SMA connector and the antenna feed point. No uncertainty required.
- SAR measured:** SAR measured at the stated antenna input power.
- SAR normalized:** SAR as measured, normalized to an input power of 1 W at the antenna connector.
- SAR for nominal TSL parameters:** The measured TSL parameters are used to calculate the nominal SAR result.

The reported uncertainty of measurement is stated as the standard uncertainty of Measurement multiplied by the coverage factor  $k=2$ , which for a normal distribution Corresponds to a coverage probability of approximately 95%.



Add: No.52 HuaYuanBei Road, Haidian District, Beijing, 100191, China  
 Tel: +86-10-62304633-2117  
 E-mail: emf@caict.ac.cn      http://www.caict.ac.cn

### Measurement Conditions

DASY system configuration, as far as not given on page 1.

<b>DASY Version</b>	DASY52	52.10.4
<b>Extrapolation</b>	Advanced Extrapolation	
<b>Phantom</b>	Triple Flat Phantom 5.1C	
<b>Distance Dipole Center - TSL</b>	10 mm	with Spacer
<b>Zoom Scan Resolution</b>	dx, dy, dz = 5 mm	
<b>Frequency</b>	2600 MHz ± 1 MHz	

### Head TSL parameters

The following parameters and calculations were applied.

	Temperature	Permittivity	Conductivity
<b>Nominal Head TSL parameters</b>	22.0 °C	39.0	1.96 mho/m
<b>Measured Head TSL parameters</b>	(22.0 ± 0.2) °C	39.2 ± 6 %	1.98 mho/m ± 6 %
<b>Head TSL temperature change during test</b>	<1.0 °C	----	----

### SAR result with Head TSL

<b>SAR averaged over 1 cm<sup>3</sup> (1 g) of Head TSL</b>	Condition	
SAR measured	250 mW input power	14.0 W/kg
SAR for nominal Head TSL parameters	normalized to 1W	<b>55.9 W/kg ± 18.8 % (k=2)</b>
<b>SAR averaged over 10 cm<sup>3</sup> (10 g) of Head TSL</b>	Condition	
SAR measured	250 mW input power	6.36 W/kg
SAR for nominal Head TSL parameters	normalized to 1W	<b>25.4 W/kg ± 18.7 % (k=2)</b>



Add: No.52 HuaYuanBei Road, Haidian District, Beijing, 100191, China  
Tel: +86-10-62304633-2117  
E-mail: emf@caict.ac.cn      <http://www.caict.ac.cn>

## Appendix (Additional assessments outside the scope of CNAS L0570)

### Antenna Parameters with Head TSL

Impedance, transformed to feed point	47.6Ω- 4.56jΩ
Return Loss	- 25.6dB

### General Antenna Parameters and Design

Electrical Delay (one direction)	1.057 ns
----------------------------------	----------

After long term use with 100W radiated power, only a slight warming of the dipole near the feed-point can be measured.

The dipole is made of standard semirigid coaxial cable. The center conductor of the feeding line is directly connected to the second arm of the dipole. The antenna is therefore short-circuited for DC-signals. On some of the dipoles, small end caps are added to the dipole arms in order to improve matching when loaded according to the position as explained in the "Measurement Conditions" paragraph. The SAR data are not affected by this change. The overall dipole length is still according to the Standard.

No excessive force must be applied to the dipole arms, because they might bend or the soldered connections near the feed-point may be damaged.

### Additional EUT Data

Manufactured by	SPEAG
-----------------	-------

Add: No.52 HuaYuanBei Road, Haidian District, Beijing, 100191, China  
Tel: +86-10-62304633-2117  
E-mail: emf@caict.ac.cn      http://www.caict.ac.cn

### DASY5 Validation Report for Head TSL

Date: 2024-06-17

Test Laboratory: CTTL, Beijing, China

**DUT: Dipole 2600 MHz; Type: D2600V2; Serial: D2600V2 - SN: 1110**

Communication System: UID 0, CW; Frequency: 2600 MHz

Medium parameters used:  $f = 2600$  MHz;  $\sigma = 1.976$  S/m;  $\epsilon_r = 39.22$ ;  $\rho = 1000$  kg/m<sup>3</sup>

Phantom section: Right Section

Measurement Standard: DASY5 (IEEE/IEC/ANSI C63.19-2007)

#### DASY5 Configuration:

- Probe: EX3DV4 - SN7307; ConvF(7.22, 7.19, 7.78) @ 2600 MHz; Calibrated: 2024-05-28
- Sensor-Surface: 1.4mm (Mechanical Surface Detection)
- Electronics: DAE4 Sn1556; Calibrated: 2024-01-03
- Phantom: MFP\_V5.1C (20deg probe tilt); Type: QD 000 P51 Cx; Serial: 1062
- DASY52 52.10.4(1535); SEMCAD X 14.6.14(7501)

**Dipole Calibration/Zoom Scan (7x7x7) (7x7x7)/Cube 0:** Measurement grid: dx=5mm, dy=5mm, dz=5mm

Reference Value = 101.3 V/m; Power Drift = -0.04 dB

Peak SAR (extrapolated) = 28.4 W/kg

**SAR(1 g) = 14 W/kg; SAR(10 g) = 6.36 W/kg**

Smallest distance from peaks to all points 3 dB below = 8.1 mm

Ratio of SAR at M2 to SAR at M1 = 50.1%

Maximum value of SAR (measured) = 23.4 W/kg

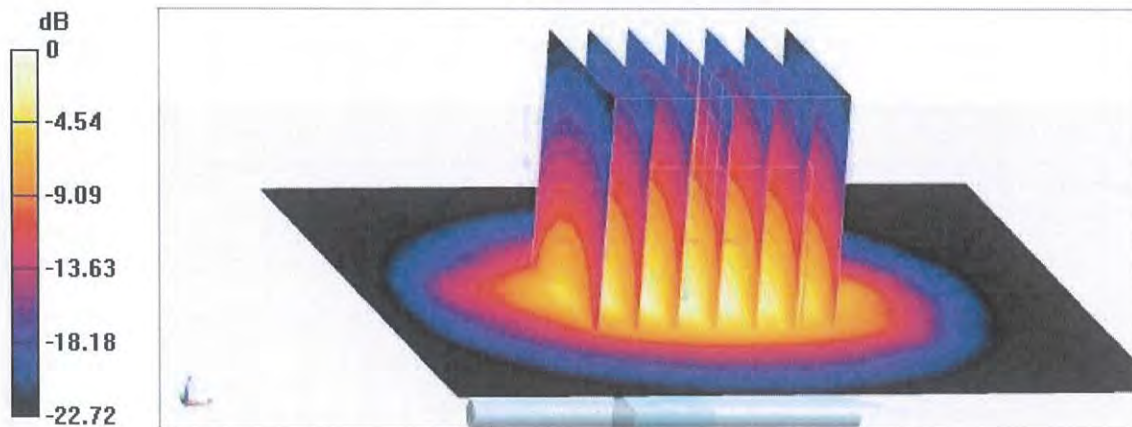

0 dB = 23.4 W/kg = 13.69 dBW/kg



Add: No.52 HuaYuanBei Road, Haidian District, Beijing, 100191, China  
Tel: +86-10-62304633-2117  
E-mail: emf@caict.ac.cn      http://www.caict.ac.cn

### Impedance Measurement Plot for Head TSL

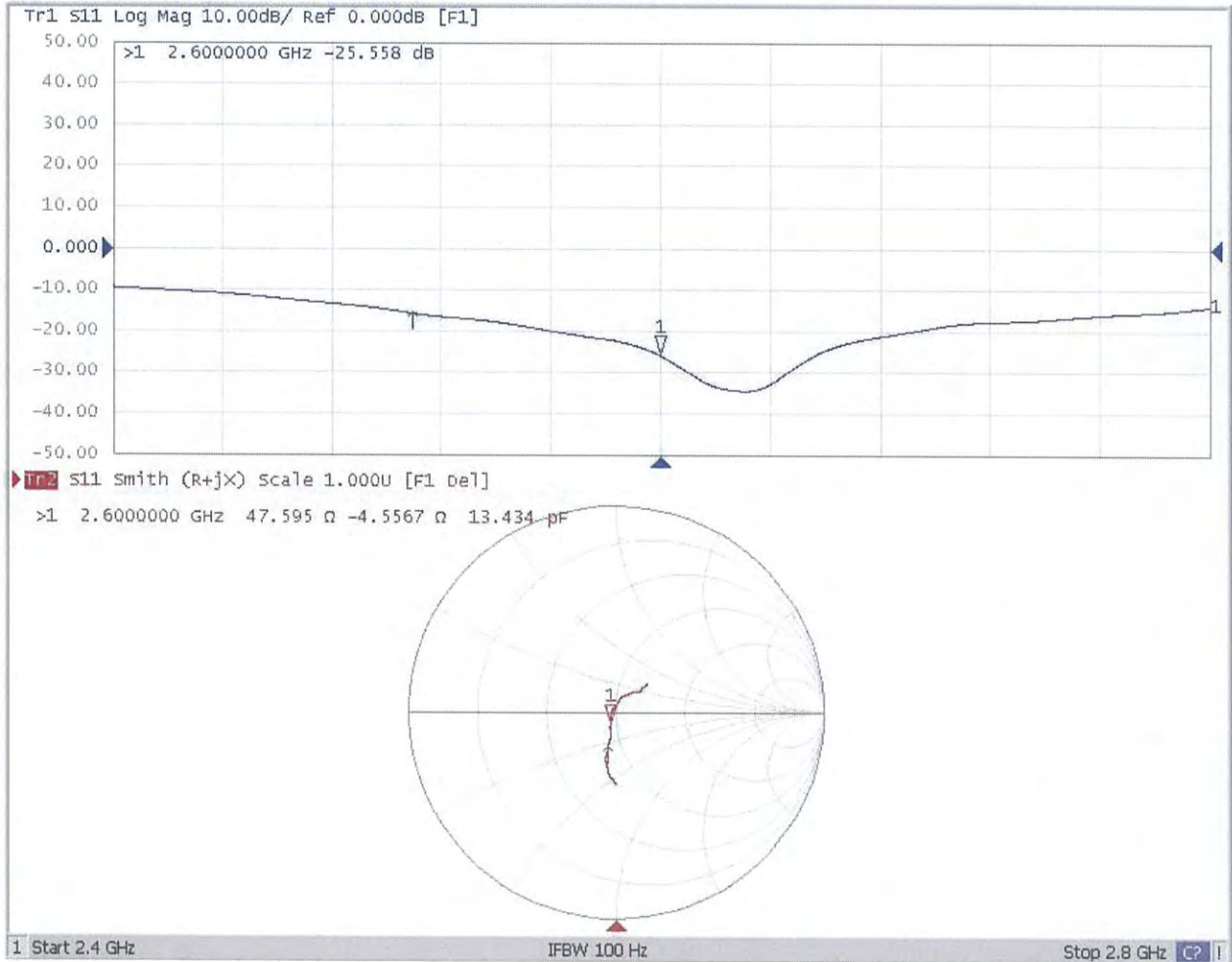



Client      **7layers**

Certificate No:      **24J02Z000860**

## CALIBRATION CERTIFICATE

Object      D3500V2 - SN: 1111

Calibration Procedure(s)      FF-Z11-003-01  
Calibration Procedures for dipole validation kits



Calibration date:      November 11, 2024

This calibration Certificate documents the traceability to national standards, which realize the physical units of measurements (SI). The measurements and the uncertainties with confidence probability are given on the following pages and are part of the certificate.

All calibrations have been conducted in the closed laboratory facility: environment temperature (22±3)°C and humidity<70%.

Calibration Equipment used (M&TE critical for calibration)

Primary Standards	ID #	Cal Date (Calibrated by, Certificate No.)	Scheduled Calibration
Power Meter NRP2	106276	17-May-24 (CTTL, No. J24X04107)	May-25
Power sensor NRP6A	101369	17-May-24 (CTTL, No. J24X04107)	May-25
Reference Probe EX3DV4	SN 7517	21-Feb-24(CTTL-SPEAG, No. 24J02Z80008)	Feb-25
DAE4	SN 1588	13-Sep-24(CTTL-SPEAG, No. 24J02Z000713)	Sep-25
Secondary Standards	ID #	Cal Date (Calibrated by, Certificate No.)	Scheduled Calibration
Signal Generator E4438C	MY49071430	25-Dec-23 (CTTL, No. J23X13426)	Dec-24
NetworkAnalyzer E5071C	MY46110673	25-Dec-23 (CTTL, No. J23X13425)	Dec-24
OCP DAK-3.5(weighted)	1040	22-Jan-24(SPEAG, No.OCP-DAK3.5-1040_Jan24)	Jan-25

	Name	Function	Signature
Calibrated by:	Zhao Jing	SAR Test Engineer	
Reviewed by:	Lin Jun	SAR Test Engineer	
Approved by:	Qi Dianyuan	SAR Project Leader	

Issued: November 15, 2024

This calibration certificate shall not be reproduced except in full without written approval of the laboratory.



In Collaboration with

**s p e a g**  
CALIBRATION LABORATORY

**CAICT**

Add: No.52 HuaYuanBei Road, Haidian District, Beijing, 100191, China

Tel: +86-10-62304633-2117

E-mail: emf@caict.ac.cn

<http://www.caict.ac.cn>

### Glossary:

TSL	tissue simulating liquid
ConvF	sensitivity in TSL / NORM <sub>x,y,z</sub>
N/A	not applicable or not measured

### Calibration is Performed According to the Following Standards:

- IEC/IEEE 62209-1528, "Measurement Procedure for The Assessment of Specific Absorption Rate of Human Exposure to Radio Frequency Fields from Hand-held and Body-mounted Wireless Communication Devices- Part 1528: Human Models, Instrumentation and Procedures (Frequency range of 4 MHz to 10 GHz)", October 2020
- KDB 865664, "SAR Measurement Requirements for 100 MHz to 6 GHz"

### Additional Documentation:

- DASY4/5 System Handbook

### Methods Applied and Interpretation of Parameters:

- Measurement Conditions:** Further details are available from the Validation Report at the end of the certificate. All figures stated in the certificate are valid at the frequency indicated.
- Antenna Parameters with TSL:** The dipole is mounted with the spacer to position its feed point exactly below the center marking of the flat phantom section, with the arms oriented parallel to the body axis.
- Feed Point Impedance and Return Loss:** These parameters are measured with the dipole positioned under the liquid filled phantom. The impedance stated is transformed from the measurement at the SMA connector to the feed point. The Return Loss ensures low reflected power. No uncertainty required.
- Electrical Delay:** One-way delay between the SMA connector and the antenna feed point. No uncertainty required.
- SAR measured:** SAR measured at the stated antenna input power.
- SAR normalized:** SAR as measured, normalized to an input power of 1 W at the antenna connector.
- SAR for nominal TSL parameters:** The measured TSL parameters are used to calculate the nominal SAR result.

The reported uncertainty of measurement is stated as the standard uncertainty of Measurement multiplied by the coverage factor  $k=2$ , which for a normal distribution Corresponds to a coverage probability of approximately 95%.



In Collaboration with

**s p e a g**  
CALIBRATION LABORATORY

Add: No.52 HuaYuanBei Road, Haidian District, Beijing, 100191, China  
 Tel: +86-10-62304633-2117  
 E-mail: emf@caict.ac.cn http://www.caict.ac.cn

**Measurement Conditions**

DASY system configuration, as far as not given on page 1.

DASY Version	DASY52	52.10.4
Extrapolation	Advanced Extrapolation	
Phantom	Triple Flat Phantom 5.1C	
Distance Dipole Center - TSL	10 mm	with Spacer
Zoom Scan Resolution	dx, dy = 4 mm, dz = 1.4 mm	Graded Ratio = 1.4 (Z direction)
Frequency	3400 MHz $\pm$ 1 MHz 3500 MHz $\pm$ 1 MHz	

**Head TSL parameters at 3400 MHz**

The following parameters and calculations were applied.

	Temperature	Permittivity	Conductivity
Nominal Head TSL parameters	22.0 °C	38.0	2.81 mho/m
Measured Head TSL parameters	(22.0 $\pm$ 0.2) °C	38.0 $\pm$ 6 %	2.80 mho/m $\pm$ 6 %
Head TSL temperature change during test	<1.0 °C	---	---

**SAR result with Head TSL at 3400 MHz**

<b>SAR averaged over 1 cm<sup>3</sup> (1 g) of Head TSL</b>	Condition	
SAR measured	100 mW input power	6.74 W/kg
SAR for nominal Head TSL parameters	normalized to 1W	<b>67.5 W/kg <math>\pm</math> 24.4 % (k=2)</b>
<b>SAR averaged over 10 cm<sup>3</sup> (10 g) of Head TSL</b>	Condition	
SAR measured	100 mW input power	2.55 W/kg
SAR for nominal Head TSL parameters	normalized to 1W	<b>25.5 W/kg <math>\pm</math> 24.2 % (k=2)</b>

**Head TSL parameters at 3500 MHz**

The following parameters and calculations were applied.

	Temperature	Permittivity	Conductivity
Nominal Head TSL parameters	22.0 °C	37.9	2.91 mho/m
Measured Head TSL parameters	(22.0 $\pm$ 0.2) °C	37.8 $\pm$ 6 %	2.92 mho/m $\pm$ 6 %
Head TSL temperature change during test	<1.0 °C	---	---

**SAR result with Head TSL at 3500 MHz**

<b>SAR averaged over 1 cm<sup>3</sup> (1 g) of Head TSL</b>	Condition	
SAR measured	100 mW input power	6.58 W/kg
SAR for nominal Head TSL parameters	normalized to 1W	<b>65.7 W/kg <math>\pm</math> 24.4 % (k=2)</b>
<b>SAR averaged over 10 cm<sup>3</sup> (10 g) of Head TSL</b>	Condition	
SAR measured	100 mW input power	2.48 W/kg
SAR for nominal Head TSL parameters	normalized to 1W	<b>24.8 W/kg <math>\pm</math> 24.2 % (k=2)</b>



Add: No.52 HuaYuanBei Road, Haidian District, Beijing, 100191, China  
 Tel: +86-10-62304633-2117  
 E-mail: emf@caict.ac.cn      http://www.caict.ac.cn

**Appendix (Additional assessments outside the scope of CNAS L0570)**

**Antenna Parameters with Head TSL at 3400 MHz**

Impedance, transformed to feed point	42.4Ω- 0.85jΩ
Return Loss	- 21.6dB

**Antenna Parameters with Head TSL at 3500 MHz**

Impedance, transformed to feed point	48.6Ω+ 3.70jΩ
Return Loss	- 27.9dB

**General Antenna Parameters and Design**

Electrical Delay (one direction)	1.043 ns
----------------------------------	----------

After long term use with 100W radiated power, only a slight warming of the dipole near the feed-point can be measured.

The dipole is made of standard semirigid coaxial cable. The center conductor of the feeding line is directly connected to the second arm of the dipole. The antenna is therefore short-circuited for DC-signals. On some of the dipoles, small end caps are added to the dipole arms in order to improve matching when loaded according to the position as explained in the "Measurement Conditions" paragraph. The SAR data are not affected by this change. The overall dipole length is still according to the Standard. No excessive force must be applied to the dipole arms, because they might bend or the soldered connections near the feed-point may be damaged.

**Additional EUT Data**

Manufactured by	SPEAG
-----------------	-------



In Collaboration with

**s p e a g**  
CALIBRATION LABORATORY

**CAICT**

Add: No.52 HuaYuanBei Road, Haidian District, Beijing, 100191, China  
Tel: +86-10-62304633-2117  
E-mail: emf@caict.ac.cn      http://www.caict.ac.cn

**DASY5 Validation Report for Head TSL**

Date: 2024-11-11

Test Laboratory: CTTL, Beijing, China

**DUT: Dipole 3500 MHz; Type: D3500V2; Serial: D3500V2 - SN: 1111**

Communication System: CW; Frequency: 3400 MHz, CW; Frequency: 3500 MHz,

Medium parameters used:  $f = 3400$  MHz;  $\sigma = 2.8$  S/m;  $\epsilon_r = 38.04$ ;  $\rho = 1000$  kg/m<sup>3</sup>,

Medium parameters used:  $f = 3500$  MHz;  $\sigma = 2.922$  S/m;  $\epsilon_r = 37.75$ ;  $\rho = 1000$  kg/m<sup>3</sup>,

Phantom section: Right Section

Measurement Standard: DASY5 (IEEE/IEC/ANSI C63.19-2007)

DASY5 Configuration:

- Probe: EX3DV4 - SN7517; ConvF(6.95, 6.95, 6.95) @ 3400 MHz; ConvF(6.72, 6.72, 6.72) @ 3500 MHz; Calibrated: 2024-02-21
- Sensor-Surface: 1.4mm (Mechanical Surface Detection)
- Electronics: DAE4 Sn1588; Calibrated: 2024-09-13
- Phantom: MFP\_V5.1C (20deg probe tilt); Type: QD 000 P51 Cx; Serial: 1062
- DASY52 52.10.4(1535); SEMCAD X 14.6.14(7501)

**Dipole Calibration /Pin=100mW, d=10mm, f=3400 MHz/Zoom Scan,**

**dist=1.4mm (8x8x7)/Cube 0:** Measurement grid: dx=4mm, dy=4mm, dz=1.4mm

Reference Value = 57.90 V/m; Power Drift = 0.04 dB

Peak SAR (extrapolated) = 17.0 W/kg

**SAR(1 g) = 6.74 W/kg; SAR(10 g) = 2.55 W/kg**

Smallest distance from peaks to all points 3 dB below = 8 mm

Ratio of SAR at M2 to SAR at M1 = 77.3%

Maximum value of SAR (measured) = 12.2 W/kg

**Dipole Calibration /Pin=100mW, d=10mm, f=3500 MHz/Zoom Scan,**

**dist=1.4mm (8x8x7)/Cube 0:** Measurement grid: dx=4mm, dy=4mm, dz=1.4mm

Reference Value = 56.01 V/m; Power Drift = 0.05 dB

Peak SAR (extrapolated) = 16.9 W/kg

**SAR(1 g) = 6.58 W/kg; SAR(10 g) = 2.48 W/kg**

Smallest distance from peaks to all points 3 dB below = 8 mm

Ratio of SAR at M2 to SAR at M1 = 76.5%

Maximum value of SAR (measured) = 12.1 W/kg



Add: No.52 HuaYuanBei Road, Haidian District, Beijing, 100191, China  
Tel: +86-10-62304633-2117  
E-mail: emf@caict.ac.cn      <http://www.caict.ac.cn>

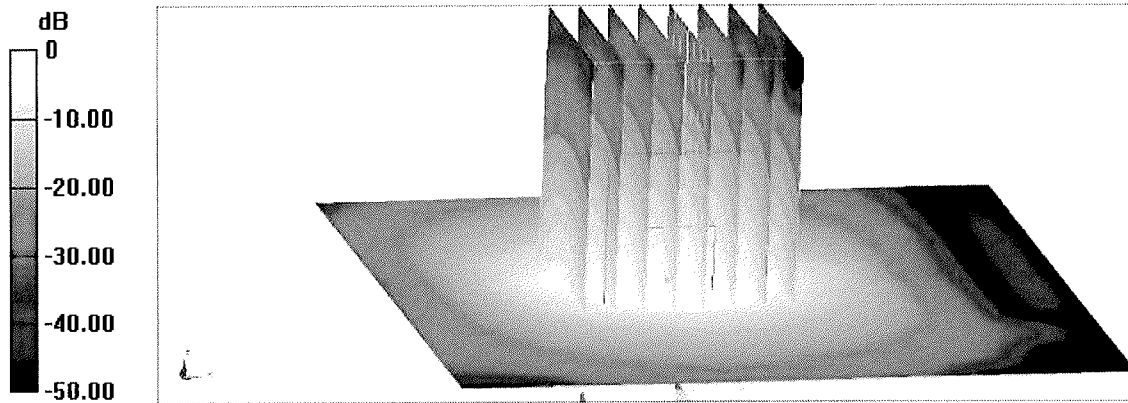

0 dB = 12.1 W/kg = 10.83 dBW/kg



Add: No.52 HuaYuanBei Road, Haidian District, Beijing, 100191, China  
Tel: +86-10-62304633-2117  
E-mail: emf@caict.ac.cn      http://www.caict.ac.cn

### Impedance Measurement Plot for Head TSL

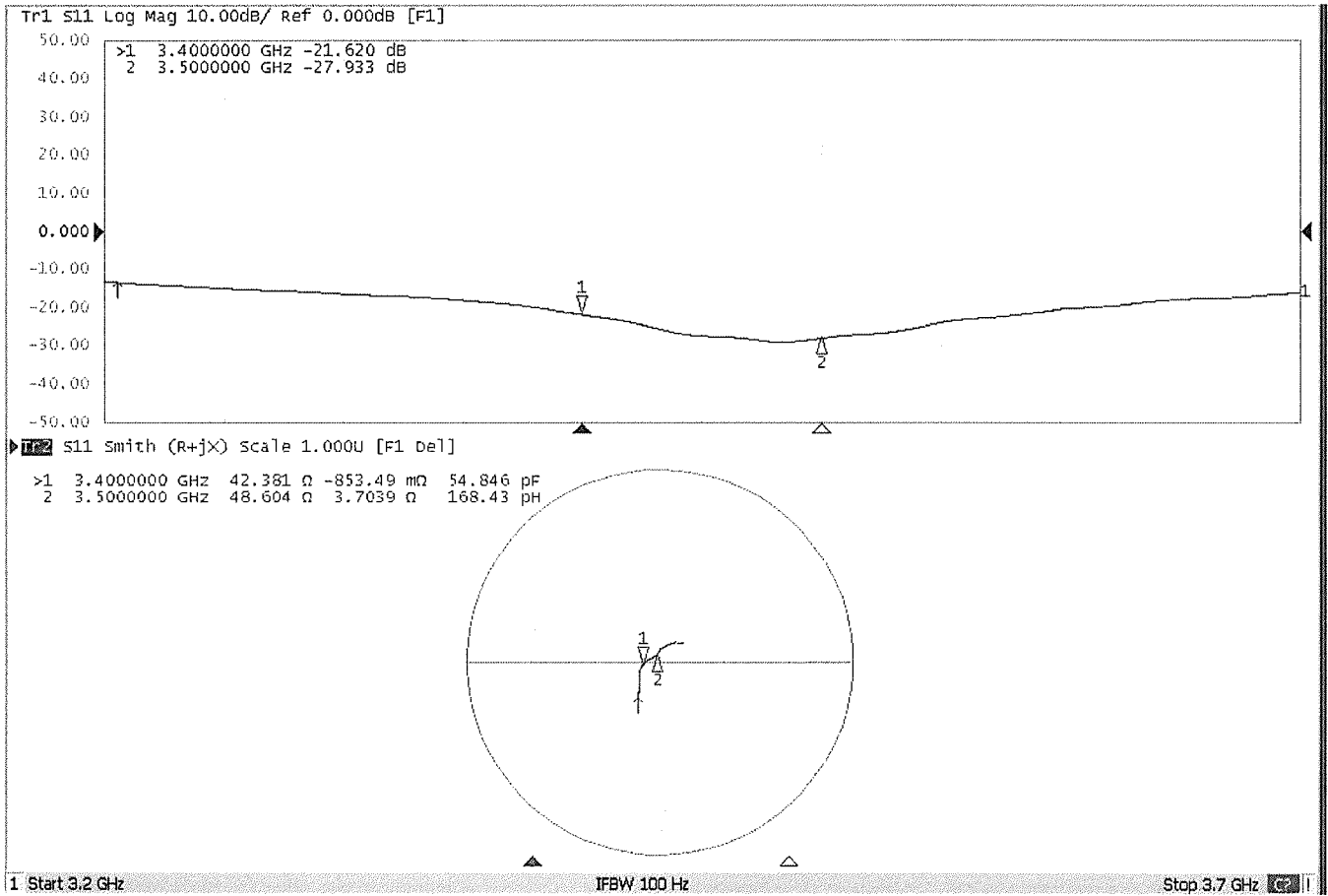

Add: No.52 HuaYuanBei Road, Haidian District, Beijing, 100191.  
Tel: +86-10-62304633-2117  
E-mail: emf@caict.ac.cn      http://www.caict.ac.cn

Client      **7layers**

Certificate No:      **24J02Z000861**

## CALIBRATION CERTIFICATE

Object      D3700V2 - SN: 1082

Calibration Procedure(s)      FF-Z11-003-01  
Calibration Procedures for dipole validation kits

Calibration date:      November 8, 2024

This calibration Certificate documents the traceability to national standards, which realize the physical units of measurements (SI). The measurements and the uncertainties with confidence probability are given on the following pages and are part of the certificate.

All calibrations have been conducted in the closed laboratory facility: environment temperature (22±3)°C and humidity<70%.

Calibration Equipment used (M&TE critical for calibration)

Primary Standards	ID #	Cal Date (Calibrated by, Certificate No.)	Scheduled Calibration
Power Meter NRP2	106276	17-May-24 (CTTL, No. J24X04107)	May-25
Power sensor NRP6A	101369	17-May-24 (CTTL, No. J24X04107)	May-25
Reference Probe EX3DV4	SN 7517	21-Feb-24(CTTL-SPEAG, No. 24J02Z80008)	Feb-25
DAE4	SN 1588	13-Sep-24(CTTL-SPEAG, No. 24J02Z000713)	Sep-25
Secondary Standards	ID #	Cal Date (Calibrated by, Certificate No.)	Scheduled Calibration
Signal Generator E4438C	MY49071430	25-Dec-23 (CTTL, No. J23X13426)	Dec-24
NetworkAnalyzer E5071C	MY46110673	25-Dec-23 (CTTL, No. J23X13425)	Dec-24
OCP DAK-3.5(weighted)	1040	22-Jan-24(SPEAG, No.OCP-DAK3.5-1040_Jan24)	Jan-25

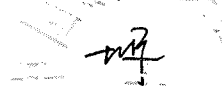
	Name	Function	Signature
Calibrated by:	Zhao Jing	SAR Test Engineer	
Reviewed by:	Lin Jun	SAR Test Engineer	
Approved by:	Qi Dianyuan	SAR Project Leader	

Issued: November 15, 2024

This calibration certificate shall not be reproduced except in full without written approval of the laboratory.





In Collaboration with

**s p e a g**  
CALIBRATION LABORATORY

**CAICT**

Add: No.52 HuaYuanBei Road, Haidian District, Beijing, 100191, China  
Tel: +86-10-62304633-2117  
E-mail: emf@caict.ac.cn      http://www.caict.ac.cn

### Glossary:

TSL	tissue simulating liquid
ConvF	sensitivity in TSL / NORM <sub>x,y,z</sub>
N/A	not applicable or not measured

### Calibration is Performed According to the Following Standards:

- a) IEC/IEEE 62209-1528, "Measurement Procedure for The Assessment of Specific Absorption Rate of Human Exposure to Radio Frequency Fields from Hand-held and Body-mounted Wireless Communication Devices- Part 1528: Human Models, Instrumentation and Procedures (Frequency range of 4 MHz to 10 GHz)", October 2020
- b) KDB 865664, "SAR Measurement Requirements for 100 MHz to 6 GHz"

### Additional Documentation:

- c) DAS4/5 System Handbook

### Methods Applied and Interpretation of Parameters:

- *Measurement Conditions:* Further details are available from the Validation Report at the end of the certificate. All figures stated in the certificate are valid at the frequency indicated.
- *Antenna Parameters with TSL:* The dipole is mounted with the spacer to position its feed point exactly below the center marking of the flat phantom section, with the arms oriented parallel to the body axis.
- *Feed Point Impedance and Return Loss:* These parameters are measured with the dipole positioned under the liquid filled phantom. The impedance stated is transformed from the measurement at the SMA connector to the feed point. The Return Loss ensures low reflected power. No uncertainty required.
- *Electrical Delay:* One-way delay between the SMA connector and the antenna feed point. No uncertainty required.
- *SAR measured:* SAR measured at the stated antenna input power.
- *SAR normalized:* SAR as measured, normalized to an input power of 1 W at the antenna connector.
- *SAR for nominal TSL parameters:* The measured TSL parameters are used to calculate the nominal SAR result.

The reported uncertainty of measurement is stated as the standard uncertainty of Measurement multiplied by the coverage factor  $k=2$ , which for a normal distribution Corresponds to a coverage probability of approximately 95%.



In Collaboration with

**s p e a g**  
CALIBRATION LABORATORY



Add: No.52 HuaYuanBei Road, Haidian District, Beijing, 100191, China  
Tel: +86-10-62304633-2117  
E-mail: emf@caict.ac.cn      http://www.caict.ac.cn

### Measurement Conditions

DASY system configuration, as far as not given on page 1.

<b>DASY Version</b>	DASY52	52.10.4
<b>Extrapolation</b>	Advanced Extrapolation	
<b>Phantom</b>	Triple Flat Phantom 5.1C	
<b>Distance Dipole Center - TSL</b>	10 mm	with Spacer
<b>Zoom Scan Resolution</b>	dx, dy = 4 mm, dz = 1.4 mm	Graded Ratio = 1.4 (Z direction)
<b>Frequency</b>	3700 MHz ± 1 MHz	

### Head TSL parameters at 3700 MHz

The following parameters and calculations were applied.

	Temperature	Permittivity	Conductivity
<b>Nominal Head TSL parameters</b>	22.0 °C	37.7	3.12 mho/m
<b>Measured Head TSL parameters</b>	(22.0 ± 0.2) °C	37.0 ± 6 %	3.11 mho/m ± 6 %
<b>Head TSL temperature change during test</b>	<1.0 °C	---	---

### SAR result with Head TSL at 3700 MHz

<b>SAR averaged over 1 cm<sup>3</sup> (1 g) of Head TSL</b>	Condition	
SAR measured	100 mW input power	6.68 W/kg
SAR for nominal Head TSL parameters	normalized to 1W	<b>66.6 W/kg ± 24.4 % (k=2)</b>
<b>SAR averaged over 10 cm<sup>3</sup> (10 g) of Head TSL</b>	Condition	
SAR measured	100 mW input power	2.43 W/kg
SAR for nominal Head TSL parameters	normalized to 1W	<b>24.2 W/kg ± 24.2 % (k=2)</b>



Add: No.52 HuaYuanBei Road, Haidian District, Beijing, 100191, China  
 Tel: +86-10-62304633-2117  
 E-mail: emf@caict.ac.cn      http://www.caict.ac.cn

**Appendix (Additional assessments outside the scope of CNAS L0570)**

**Antenna Parameters with Head TSL at 3700 MHz**

Impedance, transformed to feed point	44.6Ω+ 2.53jΩ
Return Loss	- 24.0dB

**General Antenna Parameters and Design**

Electrical Delay (one direction)	1.048 ns
----------------------------------	----------

After long term use with 100W radiated power, only a slight warming of the dipole near the feed-point can be measured.

The dipole is made of standard semirigid coaxial cable. The center conductor of the feeding line is directly connected to the second arm of the dipole. The antenna is therefore short-circuited for DC-signals. On some of the dipoles, small end caps are added to the dipole arms in order to improve matching when loaded according to the position as explained in the "Measurement Conditions" paragraph. The SAR data are not affected by this change. The overall dipole length is still according to the Standard. No excessive force must be applied to the dipole arms, because they might bend or the soldered connections near the feed-point may be damaged.

**Additional EUT Data**

Manufactured by	SPEAG
-----------------	-------

Add: No.52 HuaYuanBei Road, Haidian District, Beijing, 100191, China  
Tel: +86-10-62304633-2117  
E-mail: emf@caict.ac.cn      <http://www.caict.ac.cn>

**DASY5 Validation Report for Head TSL**

Date: 2024-11-08

Test Laboratory: CTTL, Beijing, China

**DUT: Dipole 3700 MHz; Type: D3700V2; Serial: D3700V2 - SN: 1082**

Communication System: UID 0, CW; Frequency: 3700 MHz;

Medium parameters used:  $f = 3700$  MHz;  $\sigma = 3.108$  S/m;  $\epsilon_r = 37.04$ ;  $\rho = 1000$  kg/m<sup>3</sup>

Phantom section: Right Section

Measurement Standard: DASY5 (IEEE/IEC/ANSI C63.19-2007)

**DASY5 Configuration:**

- Probe: EX3DV4 - SN7517; ConvF(6.56, 6.56, 6.56) @ 3700 MHz;  
Calibrated: 2024-02-21
- Sensor-Surface: 1.4mm (Mechanical Surface Detection)
- Electronics: DAE4 Sn1588; Calibrated: 2024-09-13
- Phantom: MFP\_V5.1C (20deg probe tilt); Type: QD 000 P51 Cx; Serial:  
1062
- DASY52 52.10.4(1535); SEMCAD X 14.6.14(7501)

**Dipole Calibration /Pin=100mW, d=10mm, f=3700 MHz/Zoom Scan,****dist=1.4mm (8x8x7)/Cube 0: Measurement grid: dx=4mm, dy=4mm, dz=1.4mm**

Reference Value = 67.22 V/m; Power Drift = -0.02 dB

Peak SAR (extrapolated) = 18.1 W/kg

**SAR(1 g) = 6.68 W/kg; SAR(10 g) = 2.43 W/kg**

Smallest distance from peaks to all points 3 dB below = 7.9 mm

Ratio of SAR at M2 to SAR at M1 = 75.1%

Maximum value of SAR (measured) = 12.6 W/kg

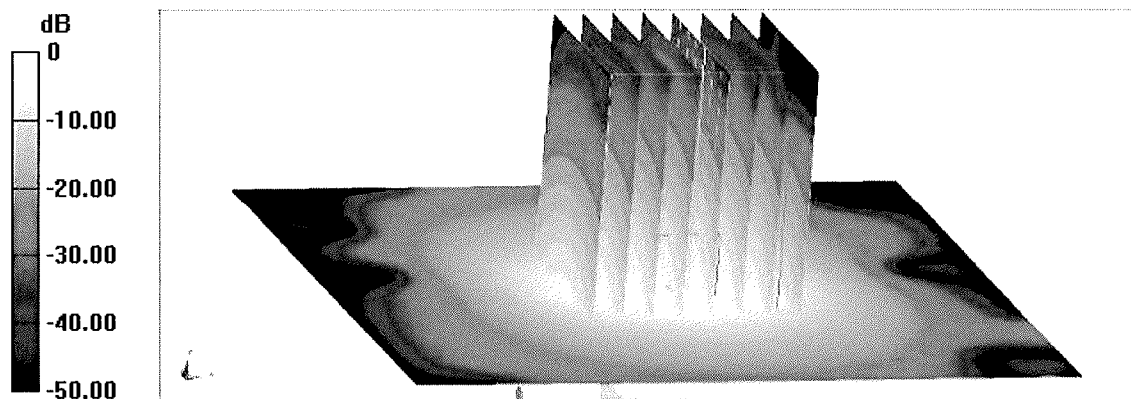

0 dB = 12.6 W/kg = 11.00 dBW/kg



Add: No.52 HuaYuanBei Road, Haidian District, Beijing, 100191, China  
Tel: +86-10-62304633-2117  
E-mail: emf@caict.ac.cn      http://www.caict.ac.cn

### Impedance Measurement Plot for Head TSL

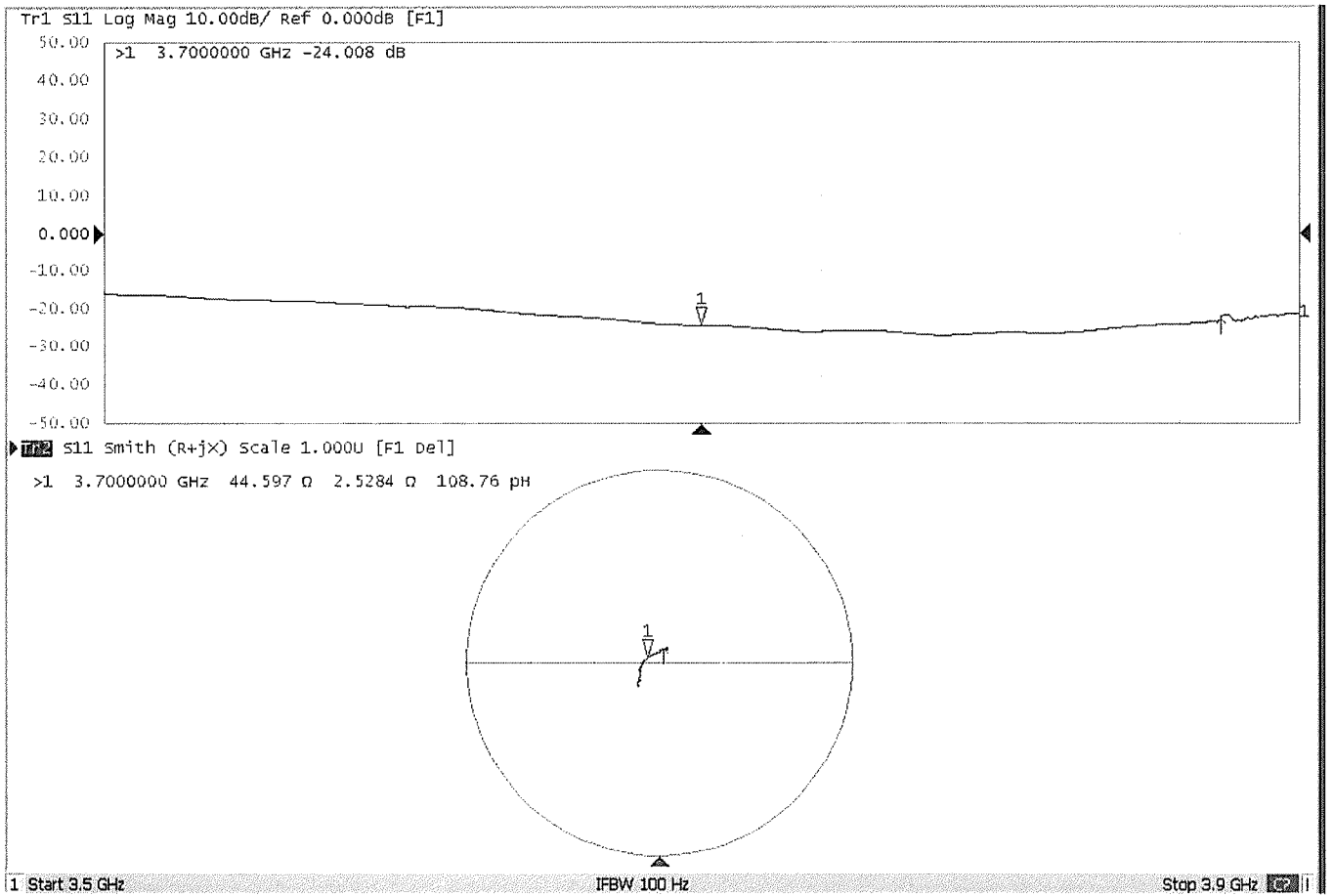

Add: No.52 HuaYuanBei Road, Haidian District, Beijing, 100191.  
Tel: +86-10-62304633-2117  
E-mail: emf@caict.ac.cn      http://www.caict.ac.cn

Client      **7layers**

Certificate No:      **24J02Z000862**

## CALIBRATION CERTIFICATE

Object      D3900V2 - SN: 1055

Calibration Procedure(s)      FF-Z11-003-01  
Calibration Procedures for dipole validation kits



Calibration date:      November 7, 2024

This calibration Certificate documents the traceability to national standards, which realize the physical units of measurements (SI). The measurements and the uncertainties with confidence probability are given on the following pages and are part of the certificate.

All calibrations have been conducted in the closed laboratory facility: environment temperature (22±3)°C and humidity<70%.

Calibration Equipment used (M&TE critical for calibration)

Primary Standards	ID #	Cal Date (Calibrated by, Certificate No.)	Scheduled Calibration
Power Meter NRP2	106276	17-May-24 (CTTL, No. J24X04107)	May-25
Power sensor NRP6A	101369	17-May-24 (CTTL, No. J24X04107)	May-25
Reference Probe EX3DV4	SN 7517	21-Feb-24(CTTL-SPEAG, No. 24J02Z80008)	Feb-25
DAE4	SN 1588	13-Sep-24(CTTL-SPEAG, No. 24J02Z000713)	Sep-25
Secondary Standards	ID #	Cal Date (Calibrated by, Certificate No.)	Scheduled Calibration
Signal Generator E4438C	MY49071430	25-Dec-23 (CTTL, No. J23X13426)	Dec-24
NetworkAnalyzer E5071C	MY46110673	25-Dec-23 (CTTL, No. J23X13425)	Dec-24
OCP DAK-3.5(weighted)	1040	22-Jan-24(SPEAG, No.OCP-DAK3.5-1040_Jan24)	Jan-25

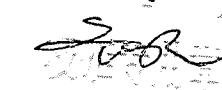
	Name	Function	Signature
Calibrated by:	Zhao Jing	SAR Test Engineer	
Reviewed by:	Lin Jun	SAR Test Engineer	
Approved by:	Qi Dianyuan	SAR Project Leader	

Issued: November 15, 2024

This calibration certificate shall not be reproduced except in full without written approval of the laboratory.



In Collaboration with

**s p e a g**  
**CALIBRATION LABORATORY**

**CAICT**

Add: No.52 HuaYuanBei Road, Haidian District, Beijing, 100191, China

Tel: +86-10-62304633-2117

E-mail: emf@caict.ac.cn

http://www.caict.ac.cn

### Glossary:

TSL	tissue simulating liquid
ConvF	sensitivity in TSL / NORM <sub>x,y,z</sub>
N/A	not applicable or not measured

### Calibration is Performed According to the Following Standards:

- a) IEC/IEEE 62209-1528, "Measurement Procedure for The Assessment of Specific Absorption Rate of Human Exposure to Radio Frequency Fields from Hand-held and Body-mounted Wireless Communication Devices- Part 1528: Human Models, Instrumentation and Procedures (Frequency range of 4 MHz to 10 GHz)", October 2020
- b) KDB 865664, "SAR Measurement Requirements for 100 MHz to 6 GHz"

### Additional Documentation:

- c) DAS4/5 System Handbook

### Methods Applied and Interpretation of Parameters:

- *Measurement Conditions:* Further details are available from the Validation Report at the end of the certificate. All figures stated in the certificate are valid at the frequency indicated.
- *Antenna Parameters with TSL:* The dipole is mounted with the spacer to position its feed point exactly below the center marking of the flat phantom section, with the arms oriented parallel to the body axis.
- *Feed Point Impedance and Return Loss:* These parameters are measured with the dipole positioned under the liquid filled phantom. The impedance stated is transformed from the measurement at the SMA connector to the feed point. The Return Loss ensures low reflected power. No uncertainty required.
- *Electrical Delay:* One-way delay between the SMA connector and the antenna feed point. No uncertainty required.
- *SAR measured:* SAR measured at the stated antenna input power.
- *SAR normalized:* SAR as measured, normalized to an input power of 1 W at the antenna connector.
- *SAR for nominal TSL parameters:* The measured TSL parameters are used to calculate the nominal SAR result.

The reported uncertainty of measurement is stated as the standard uncertainty of Measurement multiplied by the coverage factor  $k=2$ , which for a normal distribution Corresponds to a coverage probability of approximately 95%.



In Collaboration with

**s p e a g****CALIBRATION LABORATORY**

Add: No.52 HuaYuanBei Road, Haidian District, Beijing, 100191, China

Tel: +86-10-62304633-2117

E-mail: emf@caict.ac.cn

http://www.caict.ac.cn

**Measurement Conditions**

DASY system configuration, as far as not given on page 1.

<b>DASY Version</b>	DASY52	52.10.4
<b>Extrapolation</b>	Advanced Extrapolation	
<b>Phantom</b>	Triple Flat Phantom 5.1C	
<b>Distance Dipole Center - TSL</b>	10 mm	with Spacer
<b>Zoom Scan Resolution</b>	dx, dy = 4 mm, dz = 1.4 mm	Graded Ratio = 1.4 (Z direction)
<b>Frequency</b>	3900 MHz $\pm$ 1 MHz 4100 MHz $\pm$ 1 MHz	

**Head TSL parameters at 3900MHz**

The following parameters and calculations were applied.

	<b>Temperature</b>	<b>Permittivity</b>	<b>Conductivity</b>
<b>Nominal Head TSL parameters</b>	22.0 °C	37.5	3.32 mho/m
<b>Measured Head TSL parameters</b>	(22.0 $\pm$ 0.2) °C	37.3 $\pm$ 6 %	3.31 mho/m $\pm$ 6 %
<b>Head TSL temperature change during test</b>	<1.0 °C	----	----

**SAR result with Head TSL at 3900MHz**

<b>SAR averaged over 1 cm<sup>3</sup> (1 g) of Head TSL</b>	Condition	
SAR measured	100 mW input power	6.82 W/kg
SAR for nominal Head TSL parameters	normalized to 1W	<b>68.2 W/kg <math>\pm</math> 24.4 % (k=2)</b>
<b>SAR averaged over 10 cm<sup>3</sup> (10 g) of Head TSL</b>	Condition	
SAR measured	100 mW input power	2.35 W/kg
SAR for nominal Head TSL parameters	normalized to 1W	<b>23.5 W/kg <math>\pm</math> 24.2 % (k=2)</b>

**Head TSL parameters at 4100MHz**

The following parameters and calculations were applied.

	<b>Temperature</b>	<b>Permittivity</b>	<b>Conductivity</b>
<b>Nominal Head TSL parameters</b>	22.0 °C	37.2	3.53 mho/m
<b>Measured Head TSL parameters</b>	(22.0 $\pm$ 0.2) °C	36.8 $\pm$ 6 %	3.50 mho/m $\pm$ 6 %
<b>Head TSL temperature change during test</b>	<1.0 °C	----	----

**SAR result with Head TSL at 4100MHz**

<b>SAR averaged over 1 cm<sup>3</sup> (1 g) of Head TSL</b>	Condition	
SAR measured	100 mW input power	6.81 W/kg
SAR for nominal Head TSL parameters	normalized to 1W	<b>68.0 W/kg <math>\pm</math> 24.4 % (k=2)</b>
<b>SAR averaged over 10 cm<sup>3</sup> (10 g) of Head TSL</b>	Condition	
SAR measured	100 mW input power	2.33 W/kg
SAR for nominal Head TSL parameters	normalized to 1W	<b>23.2 W/kg <math>\pm</math> 24.2 % (k=2)</b>





Add: No.52 HuaYuanBei Road, Haidian District, Beijing, 100191, China  
 Tel: +86-10-62304633-2117  
 E-mail: emf@caict.ac.cn      http://www.caict.ac.cn

**Appendix (Additional assessments outside the scope of CNAS L0570)**

**Antenna Parameters with Head TSL at 3900MHz**

Impedance, transformed to feed point	47.2Ω- 3.24jΩ
Return Loss	- 27.1dB

**Antenna Parameters with Head TSL at 4100MHz**

Impedance, transformed to feed point	59.7Ω+ 2.44jΩ
Return Loss	- 20.8dB

**General Antenna Parameters and Design**

Electrical Delay (one direction)	1.011 ns
----------------------------------	----------

After long term use with 100W radiated power, only a slight warming of the dipole near the feed-point can be measured.

The dipole is made of standard semirigid coaxial cable. The center conductor of the feeding line is directly connected to the second arm of the dipole. The antenna is therefore short-circuited for DC-signals. On some of the dipoles, small end caps are added to the dipole arms in order to improve matching when loaded according to the position as explained in the "Measurement Conditions" paragraph. The SAR data are not affected by this change. The overall dipole length is still according to the Standard. No excessive force must be applied to the dipole arms, because they might bend or the soldered connections near the feed-point may be damaged.

**Additional EUT Data**

Manufactured by	SPEAG
-----------------	-------

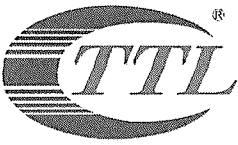

In Collaboration with

**s p e a g**

**CALIBRATION LABORATORY**



Add: No.52 HuaYuanBei Road, Haidian District, Beijing, 100191, China

Tel: +86-10-62304633-2117

E-mail: emf@caict.ac.cn

http://www.caict.ac.cn

## DASY5 Validation Report for Head TSL

Date: 2024-11-07

Test Laboratory: CTTL, Beijing, China

**DUT: Dipole 3900 MHz; Type: D3900V2; Serial: D3900V2 - SN: 1055**

Communication System: UID 0, CW; Frequency: 3900 MHz; Frequency: 4100 MHz;

Medium parameters used:  $f = 3900$  MHz;  $\sigma = 3.309$  S/m;  $\epsilon_r = 37.28$ ;  $\rho = 1000$  kg/m<sup>3</sup>

Medium parameters used:  $f = 4100$  MHz;  $\sigma = 3.5$  S/m;  $\epsilon_r = 36.78$ ;  $\rho = 1000$  kg/m<sup>3</sup>

Phantom section: Right Section

Measurement Standard: DASY5 (IEEE/IEC/ANSI C63.19-2007)

DASY5 Configuration:

- Probe: EX3DV4 - SN7517; ConvF(6.4, 6.4, 6.4) @ 3900 MHz; ConvF(6.43, 6.43, 6.43) @ 4100 MHz; Calibrated: 2024-02-21
- Sensor-Surface: 1.4mm (Mechanical Surface Detection)
- Electronics: DAE4 Sn1588; Calibrated: 2024-09-13
- Phantom: MFP\_V5.1C (20deg probe tilt); Type: QD 000 P51 Cx; Serial: 1062
- DASY52 52.10.4(1535); SEMCAD X 14.6.14(7501)

**Dipole Calibration /Pin=100mW, d=10mm, f=3900 MHz/Zoom Scan, dist=1.4mm (8x8x7)/Cube 0: Measurement grid: dx=4mm, dy=4mm, dz=1.4mm**

Reference Value = 63.07 V/m; Power Drift = 0.02 dB

Peak SAR (extrapolated) = 20.0 W/kg

**SAR(1 g) = 6.82 W/kg; SAR(10 g) = 2.35 W/kg**

Smallest distance from peaks to all points 3 dB below = 7.6 mm

Ratio of SAR at M2 to SAR at M1 = 73.2%

Maximum value of SAR (measured) = 13.3 W/kg

**Dipole Calibration /Pin=100mW, d=10mm, f=4100 MHz/Zoom Scan, dist=1.4mm (8x8x7)/Cube 0: Measurement grid: dx=4mm, dy=4mm, dz=1.4mm**

Reference Value = 62.04 V/m; Power Drift = 0.05 dB

Peak SAR (extrapolated) = 20.6 W/kg

**SAR(1 g) = 6.81 W/kg; SAR(10 g) = 2.33 W/kg**

Smallest distance from peaks to all points 3 dB below = 7.6 mm

Ratio of SAR at M2 to SAR at M1 = 71.9%

Maximum value of SAR (measured) = 13.6 W/kg



In Collaboration with

**s p e a g**

**CALIBRATION LABORATORY**

**CAICT**

Add: No.52 HuaYuanBei Road, Haidian District, Beijing, 100191, China

Tel: +86-10-62304633-2117

E-mail: emf@caict.ac.cn

<http://www.caict.ac.cn>

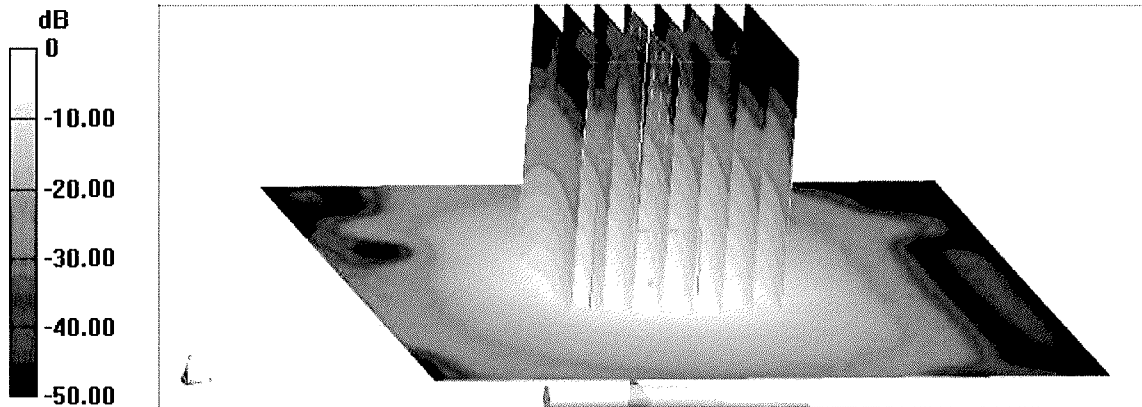

0 dB = 13.6 W/kg = 11.34 dBW/kg



Add: No.52 HuaYuanBei Road, Haidian District, Beijing, 100191, China  
Tel: +86-10-62304633-2117  
E-mail: emf@caict.ac.cn      http://www.caict.ac.cn

### Impedance Measurement Plot for Head TSL

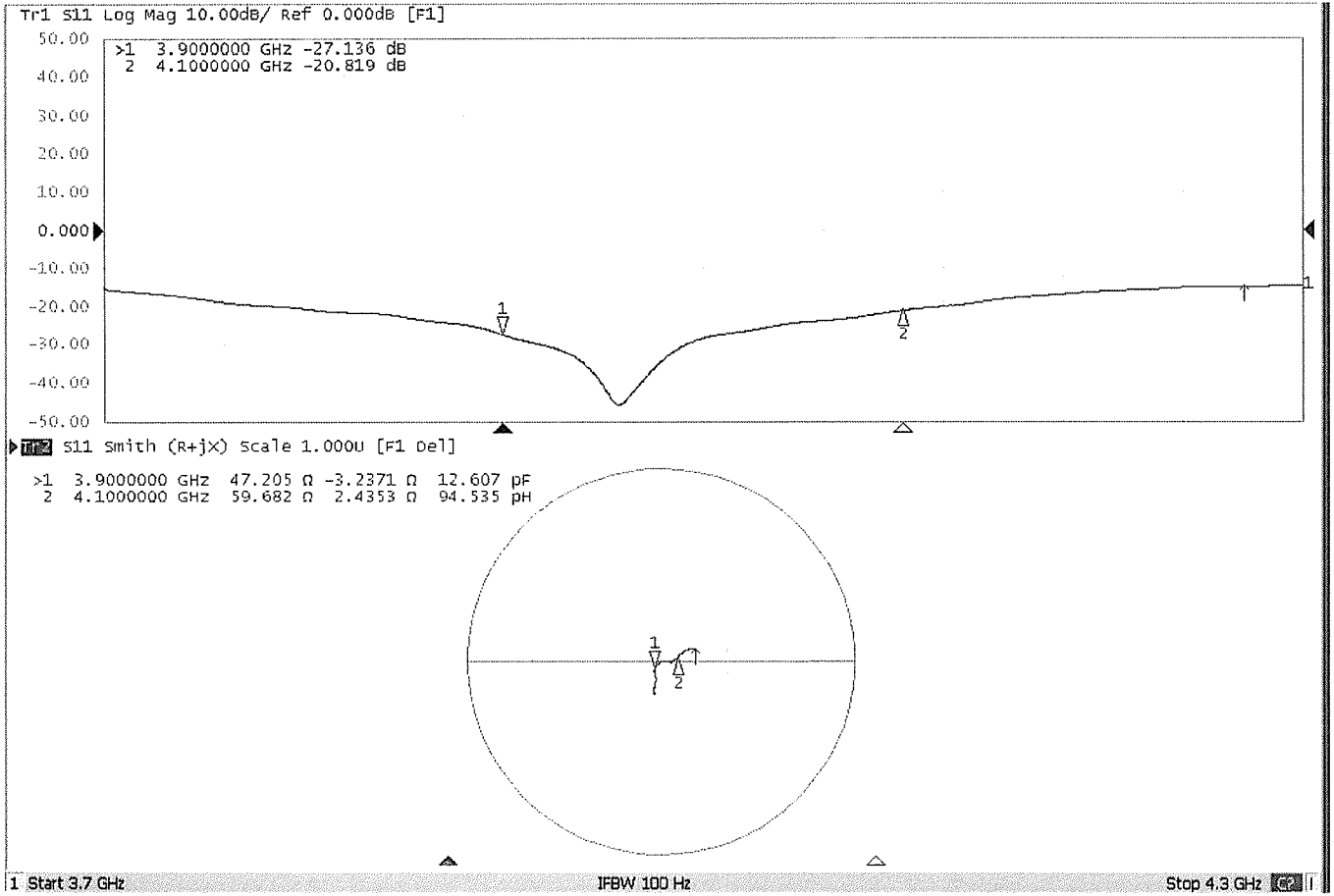

Add: No.52 HuaYuanBei Road, Haidian District, Beijing, 100191  
Tel: +86-10-62304633-2117  
E-mail: emf@caict.ac.cn      http://www.caic.ac.cn

Client **B.V.ADT**

Certificate No: **24J02Z000331**

## CALIBRATION CERTIFICATE

Object **D5GHzV2 - SN: 1133**

Calibration Procedure(s) **FF-Z11-003-01**  
**Calibration Procedures for dipole validation kits**

Calibration date: **June 15, 2024**

This calibration Certificate documents the traceability to national standards, which realize the physical units of measurements (SI). The measurements and the uncertainties with confidence probability are given on the following pages and are part of the certificate.

All calibrations have been conducted in the closed laboratory facility: environment temperature (22±3)°C and humidity<70%.

Calibration Equipment used (M&TE critical for calibration)

Primary Standards	ID #	Cal Date (Calibrated by, Certificate No.)	Scheduled Calibration
Power Meter NRP2	106276	17-May-24 (CTTL, No. J24X04107)	May-25
Power sensor NRP6A	101369	17-May-24 (CTTL, No. J24X04107)	May-25
Reference Probe EX3DV4	SN 7307	28-May-24(SPEAG, No. EX-7307_May24)	May-25
DAE4	SN 1556	03-Jan-24(CTTL-SPEAG, No.24J02Z80002)	Jan-25
Secondary Standards	ID #	Cal Date (Calibrated by, Certificate No.)	Scheduled Calibration
Signal Generator E4438C	MY49071430	25-Dec-23 (CTTL, No. J23X13426)	Dec-24
NetworkAnalyzer E5071C	MY46110673	25-Dec-23 (CTTL, No. J23X13425)	Dec-24
OCP DAK-3.5(weighted)	1040	22-Jan-24(SPEAG, No.OCP-DAK3.5-1040_Jan24)	Jan-25

	Name	Function	Signature
Calibrated by:	Zhao Jing	SAR Test Engineer	
Reviewed by:	Lin Jun	SAR Test Engineer	
Approved by:	Qi Dianyuan	SAR Project Leader	

Issued: June 22, 2024

This calibration certificate shall not be reproduced except in full without written approval of the laboratory.



Add: No.52 HuaYuanBei Road, Haidian District, Beijing, 100191, China  
Tel: +86-10-62304633-2117  
E-mail: emf@caict.ac.cn      <http://www.caic.ac.cn>

### Glossary:

TSL	tissue simulating liquid
ConvF	sensitivity in TSL / NORM <sub>x,y,z</sub>
N/A	not applicable or not measured

### Calibration is Performed According to the Following Standards:

- a) IEC/IEEE 62209-1528, "Measurement Procedure for The Assessment of Specific Absorption Rate of Human Exposure to Radio Frequency Fields from Hand-held and Body-mounted Wireless Communication Devices- Part 1528: Human Models, Instrumentation and Procedures (Frequency range of 4 MHz to 10 GHz)", October 2020
- b) KDB 865664, "SAR Measurement Requirements for 100 MHz to 6 GHz"

### Additional Documentation:

- c) DAS4/5 System Handbook

### Methods Applied and Interpretation of Parameters:

- *Measurement Conditions:* Further details are available from the Validation Report at the end of the certificate. All figures stated in the certificate are valid at the frequency indicated.
- *Antenna Parameters with TSL:* The dipole is mounted with the spacer to position its feed point exactly below the center marking of the flat phantom section, with the arms oriented parallel to the body axis.
- *Feed Point Impedance and Return Loss:* These parameters are measured with the dipole positioned under the liquid filled phantom. The impedance stated is transformed from the measurement at the SMA connector to the feed point. The Return Loss ensures low reflected power. No uncertainty required.
- *Electrical Delay:* One-way delay between the SMA connector and the antenna feed point. No uncertainty required.
- *SAR measured:* SAR measured at the stated antenna input power.
- *SAR normalized:* SAR as measured, normalized to an input power of 1 W at the antenna connector.
- *SAR for nominal TSL parameters:* The measured TSL parameters are used to calculate the nominal SAR result.

The reported uncertainty of measurement is stated as the standard uncertainty of Measurement multiplied by the coverage factor  $k=2$ , which for a normal distribution Corresponds to a coverage probability of approximately 95%.



Add: No.52 HuaYuanBei Road, Haidian District, Beijing, 100191, China  
 Tel: +86-10-62304633-2117  
 E-mail: emf@caict.ac.cn      http://www.caic.ac.cn

### Measurement Conditions

DASY system configuration, as far as not given on page 1.

<b>DASY Version</b>	DASY52	52.10.4
<b>Extrapolation</b>	Advanced Extrapolation	
<b>Phantom</b>	Triple Flat Phantom 5.1C	
<b>Distance Dipole Center - TSL</b>	10 mm	with Spacer
<b>Zoom Scan Resolution</b>	dx, dy = 4 mm, dz = 1.4 mm	Graded Ratio = 1.4 (Z direction)
<b>Frequency</b>	5250 MHz ± 1 MHz 5600 MHz ± 1 MHz 5750 MHz ± 1 MHz	

### Head TSL parameters at 5250MHz

The following parameters and calculations were applied.

	Temperature	Permittivity	Conductivity
<b>Nominal Head TSL parameters</b>	22.0 °C	35.9	4.71 mho/m
<b>Measured Head TSL parameters</b>	(22.0 ± 0.2) °C	36.2 ± 6 %	4.65 mho/m ± 6 %
<b>Head TSL temperature change during test</b>	<1.0 °C	----	----

### SAR result with Head TSL at 5250MHz

<b>SAR averaged over 1 cm<sup>3</sup> (1 g) of Head TSL</b>	Condition	
SAR measured	100 mW input power	7.76 W/kg
SAR for nominal Head TSL parameters	normalized to 1W	<b>77.7 W/kg ± 24.4 % (k=2)</b>
<b>SAR averaged over 10 cm<sup>3</sup> (10 g) of Head TSL</b>	Condition	
SAR measured	100 mW input power	2.20 W/kg
SAR for nominal Head TSL parameters	normalized to 1W	<b>22.0 W/kg ± 24.2 % (k=2)</b>

Add: No.52 HuaYuanBei Road, Haidian District, Beijing, 100191, China  
Tel: +86-10-62304633-2117  
E-mail: emf@caict.ac.cn      http://www.caic.ac.cn

### Head TSL parameters at 5600MHz

The following parameters and calculations were applied.

	Temperature	Permittivity	Conductivity
Nominal Head TSL parameters	22.0 °C	35.5	5.07 mho/m
Measured Head TSL parameters	(22.0 ± 0.2) °C	35.6 ± 6 %	5.02 mho/m ± 6 %
Head TSL temperature change during test	<1.0 °C	---	---

### SAR result with Head TSL at 5600MHz

<b>SAR averaged over 1 cm<sup>3</sup> (1 g) of Head TSL</b>	Condition	
SAR measured	100 mW input power	8.24 W/kg
SAR for nominal Head TSL parameters	normalized to 1W	<b>82.4 W/kg ± 24.4 % (k=2)</b>
<b>SAR averaged over 10 cm<sup>3</sup> (10 g) of Head TSL</b>	Condition	
SAR measured	100 mW input power	2.32 W/kg
SAR for nominal Head TSL parameters	normalized to 1W	<b>23.2 W/kg ± 24.2 % (k=2)</b>

### Head TSL parameters at 5750MHz

The following parameters and calculations were applied.

	Temperature	Permittivity	Conductivity
Nominal Head TSL parameters	22.0 °C	35.4	5.22 mho/m
Measured Head TSL parameters	(22.0 ± 0.2) °C	35.4 ± 6 %	5.19 mho/m ± 6 %
Head TSL temperature change during test	<1.0 °C	---	---

### SAR result with Head TSL at 5750MHz

<b>SAR averaged over 1 cm<sup>3</sup> (1 g) of Head TSL</b>	Condition	
SAR measured	100 mW input power	7.86 W/kg
SAR for nominal Head TSL parameters	normalized to 1W	<b>78.6 W/kg ± 24.4 % (k=2)</b>
<b>SAR averaged over 10 cm<sup>3</sup> (10 g) of Head TSL</b>	Condition	
SAR measured	100 mW input power	2.20 W/kg
SAR for nominal Head TSL parameters	normalized to 1W	<b>22.0 W/kg ± 24.2 % (k=2)</b>





Add: No.52 HuaYuanBei Road, Haidian District, Beijing, 100191, China  
 Tel: +86-10-62304633-2117  
 E-mail: emf@caict.ac.cn      <http://www.caic.ac.cn>

## Appendix (Additional assessments outside the scope of CNAS L0570)

### Antenna Parameters with Head TSL at 5250MHz

Impedance, transformed to feed point	48.7Ω- 4.61jΩ
Return Loss	- 26.3dB

### Antenna Parameters with Head TSL at 5600MHz

Impedance, transformed to feed point	54.4Ω+ 2.46jΩ
Return Loss	- 26.4dB

### Antenna Parameters with Head TSL at 5750MHz

Impedance, transformed to feed point	54.0Ω- 0.52jΩ
Return Loss	- 28.1dB

### General Antenna Parameters and Design

Electrical Delay (one direction)	1.112 ns
----------------------------------	----------

After long term use with 100W radiated power, only a slight warming of the dipole near the feed-point can be measured.

The dipole is made of standard semirigid coaxial cable. The center conductor of the feeding line is directly connected to the second arm of the dipole. The antenna is therefore short-circuited for DC-signals. On some of the dipoles, small end caps are added to the dipole arms in order to improve matching when loaded according to the position as explained in the "Measurement Conditions" paragraph. The SAR data are not affected by this change. The overall dipole length is still according to the Standard.

No excessive force must be applied to the dipole arms, because they might bend or the soldered connections near the feed-point may be damaged.

### Additional EUT Data

Manufactured by	SPEAG
-----------------	-------



In Collaboration with

**s p e a g**  
CALIBRATION LABORATORY



Add: No.52 HuaYuanBei Road, Haidian District, Beijing, 100191, China

Tel: +86-10-62304633-2117

E-mail: emf@caict.ac.cn

http://www.caic.ac.cn

Date: 2024-06-15

## DASY5 Validation Report for Head TSL

Test Laboratory: CTTL, Beijing, China

**DUT: Dipole 5GHz; Type: D5GHzV2; Serial: D5GHzV2 - SN: 1133**

Communication System: CW; Frequency: 5250 MHz, Frequency: 5600 MHz,  
Frequency: 5750 MHz

Medium parameters used:  $f = 5250$  MHz;  $\sigma = 4.648$  S/m;  $\epsilon_r = 36.22$ ;  $\rho = 1000$  kg/m<sup>3</sup>

Medium parameters used:  $f = 5600$  MHz;  $\sigma = 5.023$  S/m;  $\epsilon_r = 35.61$ ;  $\rho = 1000$  kg/m<sup>3</sup>

Medium parameters used:  $f = 5750$  MHz;  $\sigma = 5.185$  S/m;  $\epsilon_r = 35.39$ ;  $\rho = 1000$  kg/m<sup>3</sup>

Phantom section: Right Section

Measurement Standard: DASY5 (IEEE/IEC/ANSI C63.19-2007)

DASY5 Configuration:

- Probe: EX3DV4 - SN7307; ConvF(5.37, 5.49, 5.89) @ 5250 MHz; ConvF(4.66, 4.74, 5.05) @ 5600 MHz; ConvF(4.69, 4.76, 5.08) @ 5750 MHz; Calibrated: 2024-05-28
- Sensor-Surface: 1.4mm (Mechanical Surface Detection)
- Electronics: DAE4 Sn1556; Calibrated: 2024-01-03
- Phantom: MFP\_V5.1C (20deg probe tilt); Type: QD 000 P51 Cx; Serial: 1062
- DASY52 52.10.4(1535); SEMCAD X 14.6.14(7501)

**Dipole Calibration /Pin=100mW, d=10mm, f=5250 MHz/Zoom Scan,**

**dist=1.4mm (8x8x7)/Cube 0:** Measurement grid: dx=4mm, dy=4mm, dz=1.4mm

Reference Value = 57.23 V/m; Power Drift = -0.01 dB

Peak SAR (extrapolated) = 31.0 W/kg

**SAR(1 g) = 7.76 W/kg; SAR(10 g) = 2.2 W/kg**

Smallest distance from peaks to all points 3 dB below = 7.2 mm

Ratio of SAR at M2 to SAR at M1 = 65.9%

Maximum value of SAR (measured) = 17.8 W/kg

**Dipole Calibration /Pin=100mW, d=10mm, f=5600 MHz/Zoom Scan,**

**dist=1.4mm (8x8x7)/Cube 0:** Measurement grid: dx=4mm, dy=4mm, dz=1.4mm

Reference Value = 58.59 V/m; Power Drift = -0.01 dB

Peak SAR (extrapolated) = 35.2 W/kg

**SAR(1 g) = 8.24 W/kg; SAR(10 g) = 2.32 W/kg**

Smallest distance from peaks to all points 3 dB below = 7.2 mm

Ratio of SAR at M2 to SAR at M1 = 63.4%

Maximum value of SAR (measured) = 19.5 W/kg

Add: No.52 HuaYuanBei Road, Haidian District, Beijing, 100191, China  
Tel: +86-10-62304633-2117  
E-mail: emf@caict.ac.cn <http://www.caic.ac.cn>

**Dipole Calibration /Pin=100mW, d=10mm, f=5750 MHz/Zoom Scan,**  
**dist=1.4mm (8x8x7)/Cube 0:** Measurement grid: dx=4mm, dy=4mm, dz=1.4mm  
Reference Value = 57.19 V/m; Power Drift = -0.02 dB  
Peak SAR (extrapolated) = 34.6 W/kg  
**SAR(1 g) = 7.86 W/kg; SAR(10 g) = 2.2 W/kg**  
Smallest distance from peaks to all points 3 dB below = 7.2 mm  
Ratio of SAR at M2 to SAR at M1 = 62.4%  
Maximum value of SAR (measured) = 18.9 W/kg

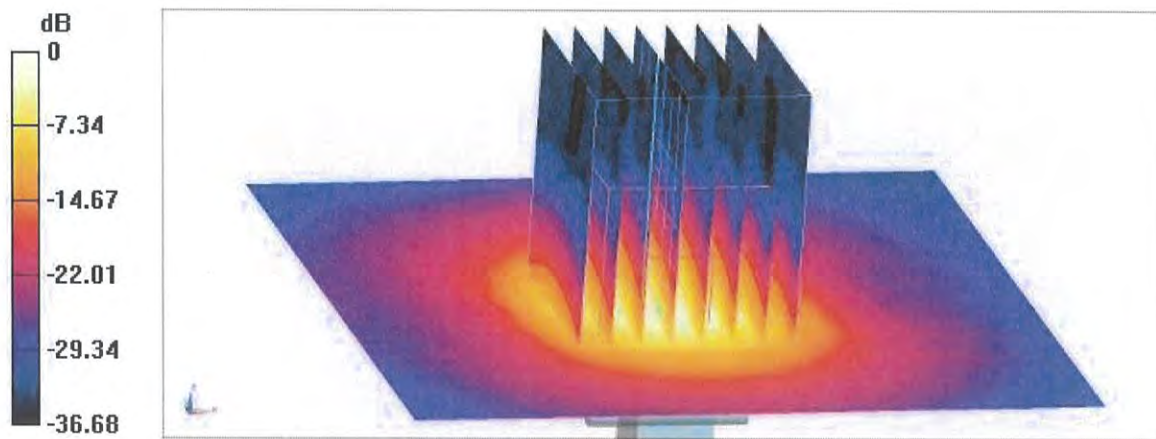

0 dB = 18.9 W/kg = 12.76 dBW/kg



Add: No.52 HuaYuanBei Road, Haidian District, Beijing, 100191, China  
Tel: +86-10-62304633-2117  
E-mail: emf@caict.ac.cn      http://www.caic.ac.cn

### Impedance Measurement Plot for Head TSL

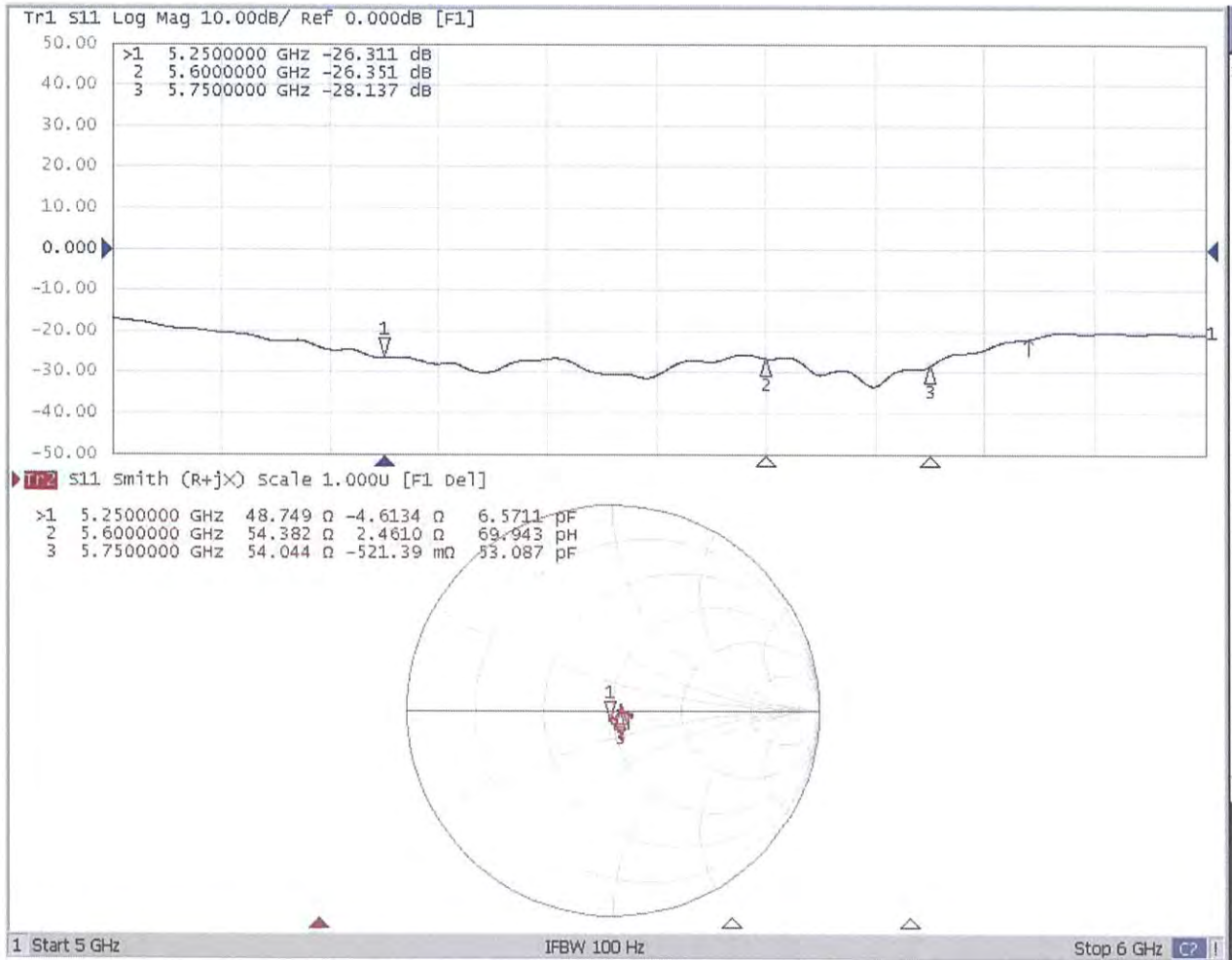

Client : **B.V.ADT**

Certificate No: **24J02Z000881**

## CALIBRATION CERTIFICATE

Object **DAE4 - SN: 1389**

Calibration Procedure(s) **FF-Z11-002-01  
Calibration Procedure for the Data Acquisition Electronics (DAEx)**

Calibration date: **November 11, 2024**



This calibration Certificate documents the traceability to national standards, which realize the physical units of measurements(SI). The measurements and the uncertainties with confidence probability are given on the following pages and are part of the certificate.

All calibrations have been conducted in the closed laboratory facility: environment temperature(22±3)°C and humidity<70%.

Calibration Equipment used (M&TE critical for calibration)

Primary Standards	ID #	Cal Date(Calibrated by, Certificate No.)	Scheduled Calibration
-------------------	------	--	-----------------------

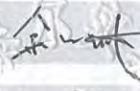
Process Calibrator 753	1971018	11-Jun-24 (CTTL, No.24J02X005147)	Jun-25
------------------------	---------	-----------------------------------	--------

	Name	Function	Signature
Calibrated by:	Yu Zongying	SAR Test Engineer	
Reviewed by:	Lin Jun	SAR Test Engineer	
Approved by:	Qi Dianyuan	SAR Project Leader	

Issued: November 13, 2024

This calibration certificate shall not be reproduced except in full without written approval of the laboratory.



Add: No.52 HuaYuanBei Road, Haidian District, Beijing, 100191, China  
Tel: +86-10-62304633-2117  
E-mail: emf@caict.ac.cn <http://www.caict.ac.cn>

### Glossary:

DAE data acquisition electronics  
Connector angle information used in DASY system to align probe sensor X to the robot coordinate system.

### Methods Applied and Interpretation of Parameters:

- *DC Voltage Measurement:* Calibration Factor assessed for use in DASY system by comparison with a calibrated instrument traceable to national standards. The figure given corresponds to the full scale range of the voltmeter in the respective range.
- *Connector angle:* The angle of the connector is assessed measuring the angle mechanically by a tool inserted. Uncertainty is not required.
- The report provide only calibration results for DAE, it does not contain other performance test results.



Add: No.52 HuaYuanBei Road, Haidian District, Beijing, 100191, China  
 Tel: +86-10-62304633-2117  
 E-mail: emf@caict.ac.cn <http://www.caict.ac.cn>

### DC Voltage Measurement

A/D - Converter Resolution nominal

High Range: 1LSB = 6.1μV, full range = -100...+300 mV

Low Range: 1LSB = 61nV, full range = -1.....+3mV

DASY measurement parameters: Auto Zero Time: 3 sec; Measuring time: 3 sec

Calibration Factors	X	Y	Z
High Range	403.775 ± 0.15% (k=2)	403.739 ± 0.15% (k=2)	404.203 ± 0.15% (k=2)
Low Range	3.98142 ± 0.7% (k=2)	3.96476 ± 0.7% (k=2)	4.02443 ± 0.7% (k=2)

### Connector Angle

Connector Angle to be used in DASY system	131° ± 1 °
---	------------

Client

**ADT-SZ**

Certificate No: **24J02Z000608**

## CALIBRATION CERTIFICATE

Object: **EX3DV4 - SN : 3873**

Calibration Procedure(s): **FF-Z11-004-02**  
**Calibration Procedures for Dosimetric E-field Probes**



Calibration date: **September 29, 2024**

This calibration Certificate documents the traceability to national standards, which realize the physical units of measurements(SI). The measurements and the uncertainties with confidence probability are given on the following pages and are part of the certificate.

All calibrations have been conducted in the closed laboratory facility: environment temperature(22±3)°C and humidity<70%.

Calibration Equipment used (M&TE critical for calibration)

Primary Standards	ID #	Cal Date(Calibrated by, Certificate No.)	Scheduled Calibration
Power Meter NRP2	106277	19-Oct-23(CTTL, No.J23X11026)	Oct-24
Power sensor NRP8S	104291	19-Oct-23(CTTL, No.J23X11026)	Oct-24
Power sensor NRP8S	104292	19-Oct-23(CTTL, No.J23X11026)	Oct-24
Reference 10dBAttenuator	18N50W-10dB	19-Jan-23(CTTL, No.J23X00212)	Jan-25
Reference 20dBAttenuator	18N50W-20dB	19-Jan-23(CTTL, No.J23X00211)	Jan-25
Reference Probe EX3DV4	SN 7307	28-May-24(SPEAG, No.EX-7307_May24)	May-25
DAE4	SN 771	19-Jan-24(SPEAG, No.DAE4-771_Jan24)	Jan-25
Secondary Standards	ID #	Cal Date(Calibrated by, Certificate No.)	Scheduled Calibration
SignalGenerator MG3700A	6201052605	12-Jun-24(CTTL, No.24J02X005419)	Jun-25
SignalGenerator APSIN26G	181-33A6D0700-1959	26-Mar-24(CTTL, No.24J02X002468)	Mar-25
Network Analyzer E5071C	MY46110673	25-Dec-23(CTTL, No.J23X13425)	Dec-24
Reference 10dBAttenuator	BT0520	11-May-23(CTTL, No.J23X04061)	May-25
Reference 20dBAttenuator	BT0267	11-May-23(CTTL, No.J23X04062)	May-25
OCP DAK-3.5	SN 1040	22-Jan-24(SPEAG, No.OCP-DAK3.5-1040_Jan24)	Jan-25

	Name	Function	Signature
Calibrated by:	Yu Zongying	SAR Test Engineer	
Reviewed by:	Lin Jun	SAR Test Engineer	
Approved by:	Qi Dianyuan	SAR Project Leader	

Issued: October 05, 2024

This calibration certificate shall not be reproduced except in full without written approval of the laboratory.





## Glossary:

TSL	tissue simulating liquid
NORM <sub>x,y,z</sub>	sensitivity in free space
ConvF	sensitivity in TSL / NORM <sub>x,y,z</sub>
DCP	diode compression point
CF	crest factor (1/duty_cycle) of the RF signal
A,B,C,D	modulation dependent linearization parameters
Polarization $\Phi$	$\Phi$ rotation around probe axis
Polarization $\theta$	$\theta$ rotation around an axis that is in the plane normal to probe axis (at measurement center), $\theta=0$ is normal to probe axis
Connector Angle	information used in DASY system to align probe sensor X to the robot coordinate system

## Calibration is Performed According to the Following Standards:

- IEEE Std 1528-2013, "IEEE Recommended Practice for Determining the Peak Spatial-Averaged Specific Absorption Rate (SAR) in the Human Head from Wireless Communications Devices: Measurement Techniques", June 2013
- IEC 62209-1, "Measurement procedure for the assessment of Specific Absorption Rate (SAR) from hand-held and body-mounted devices used next to the ear (frequency range of 300 MHz to 6 GHz)", July 2016
- IEC 62209-2, "Procedure to determine the Specific Absorption Rate (SAR) for wireless communication devices used in close proximity to the human body (frequency range of 30 MHz to 6 GHz)", March 2010
- KDB 865664, "SAR Measurement Requirements for 100 MHz to 6 GHz"

## Methods Applied and Interpretation of Parameters:

- NORM<sub>x,y,z</sub>**: Assessed for E-field polarization  $\theta=0$  ( $f \leq 900$  MHz in TEM-cell;  $f > 1800$  MHz: waveguide). NORM<sub>x,y,z</sub> are only intermediate values, i.e., the uncertainties of NORM<sub>x,y,z</sub> does not effect the  $E^2$ -field uncertainty inside TSL (see below ConvF).
- NORM(f)<sub>x,y,z</sub>** = NORM<sub>x,y,z</sub> \* frequency\_response (see Frequency Response Chart). This linearization is implemented in DASY4 software versions later than 4.2. The uncertainty of the frequency response is included in the stated uncertainty of ConvF.
- DCP<sub>x,y,z</sub>**: DCP are numerical linearization parameters assessed based on the data of power sweep (no uncertainty required). DCP does not depend on frequency nor media.
- PAR**: PAR is the Peak to Average Ratio that is not calibrated but determined based on the signal characteristics.
- A<sub>x,y,z</sub>; B<sub>x,y,z</sub>; C<sub>x,y,z</sub>; VR<sub>x,y,z</sub>**: A,B,C are numerical linearization parameters assessed based on the data of power sweep for specific modulation signal. The parameters do not depend on frequency nor media. VR is the maximum calibration range expressed in RMS voltage across the diode.
- ConvF and Boundary Effect Parameters**: Assessed in flat phantom using E-field (or Temperature Transfer Standard for  $f \leq 800$  MHz) and inside waveguide using analytical field distributions based on power measurements for  $f > 800$  MHz. The same setups are used for assessment of the parameters applied for boundary compensation (alpha, depth) of which typical uncertainty valued are given. These parameters are used in DASY4 software to improve probe accuracy close to the boundary. The sensitivity in TSL corresponds to NORM<sub>x,y,z</sub> \* ConvF whereby the uncertainty corresponds to that given for ConvF. A frequency dependent ConvF is used in DASY version 4.4 and higher which allows extending the validity from  $\pm 50$  MHz to  $\pm 100$  MHz.
- Spherical isotropy (3D deviation from isotropy)**: in a field of low gradients realized using a flat phantom exposed by a patch antenna.
- Sensor Offset**: The sensor offset corresponds to the offset of virtual measurement center from the probe tip (on probe axis). No tolerance required.
- Connector Angle**: The angle is assessed using the information gained by determining the NORM<sub>x</sub> (no uncertainty required).

Add: No.52 HuaYuanBei Road, Haidian District, Beijing, 100191, China  
Tel: +86-10-62304633-2117  
E-mail: emf@caict.ac.cn      http://www.caict.ac.cn

## DASY/EASY – Parameters of Probe: EX3DV4 – SN: 3873

### Basic Calibration Parameters

	Sensor X	Sensor Y	Sensor Z	Unc (k=2)
Norm( $\mu\text{V}/(\text{V}/\text{m})^2$ ) <sup>A</sup>	0.38	0.46	0.49	±10.0%
DCP(mV) <sup>B</sup>	101.7	100.5	100.8	

### Calibration Results for Modulation Response

UID	Communication System Name		A dB	B dB $\sqrt{\mu\text{V}}$	C	D dB	VR mV	Max Dev.	Max Unc <sup>E</sup> (k=2)
0	CW	X	0.0	0.0	1.0	0.00	145.7	±1.9%	±4.7%
		Y	0.0	0.0	1.0		163.2		
		Z	0.0	0.0	1.0		166.7		
10352-AAA	Pulse Waveform (200Hz, 10%)	X	8.17	78.52	15.33	10.00	60	±3.7%	±9.6%
		Y	4.26	71.20	12.59		60		
		Z	7.06	76.11	14.65		60		
10353-AAA	Pulse Waveform (200Hz, 20%)	X	20.00	86.77	16.46	6.99	80	±2.3%	±9.6%
		Y	3.94	71.75	11.79		80		
		Z	18.89	85.28	16.34		80		
10354-AAA	Pulse Waveform (200Hz, 40%)	X	20.00	84.46	13.98	3.98	95	±1.4%	±9.6%
		Y	1.52	66.22	8.57		95		
		Z	20.00	83.76	14.28		95		
10355-AAA	Pulse Waveform (200Hz, 60%)	X	0.31	60.00	4.60	2.22	120	±1.4%	±9.6%
		Y	0.39	60.18	4.80		120		
		Z	0.52	60.99	5.72		120		
10387-AAA	QPSK Waveform, 1 MHz	X	1.56	65.11	14.09	1.00	150	±2.3%	±9.6%
		Y	1.50	64.29	13.32		150		
		Z	1.51	64.02	13.40		150		
10388-AAA	QPSK Waveform, 10 MHz	X	2.14	67.53	15.04	0.00	150	±1.2%	±9.6%
		Y	2.05	66.50	14.33		150		
		Z	2.04	66.35	14.29		150		
10396-AAA	64-QAM Waveform, 100 kHz	X	3.30	73.51	20.73	3.01	150	±0.6%	±9.6%
		Y	2.72	69.25	18.47		150		
		Z	2.97	70.62	19.24		150		
10414-AAA	WLAN CCDF, 64-QAM, 40MHz	X	4.91	65.87	15.58	0.00	150	±3.6%	±9.6%
		Y	4.80	65.38	15.23		150		
		Z	4.90	65.61	15.39		150		

**Note:** For details on UID parameters see Appendix

The reported uncertainty of measurement is stated as the standard uncertainty of Measurement multiplied by the coverage factor  $k=2$ , which for a normal distribution Corresponds to a coverage probability of approximately 95%.

<sup>A</sup> The uncertainties of Norm X, Y, Z do not affect the  $E^2$ -field uncertainty inside TSL (see Page 5).

<sup>B</sup> Numerical linearization parameter: uncertainty not required.

<sup>E</sup> Uncertainty is determined using the max. deviation from linear response applying rectangular distribution and is expressed for the square of the field value.



Add: No.52 HuaYuanBei Road, Haidian District, Beijing, 100191, China  
 Tel: +86-10-62304633-2117  
 E-mail: emf@caict.ac.cn      <http://www.caict.ac.cn>

## DASY/EASY – Parameters of Probe: EX3DV4 – SN: 3873

### Sensor Model Parameters

	C1 fF	C2 fF	$\alpha$ V <sup>-1</sup>	T1 ms.V <sup>-2</sup>	T2 ms.V <sup>-1</sup>	T3 ms	T4 V <sup>-2</sup>	T5 V <sup>-1</sup>	T6
<b>X</b>	50.52	382.08	36.23	10.64	0.00	5.10	0.73	0.33	1.02
<b>Y</b>	47.84	364.98	36.61	13.54	0.00	5.08	0.00	0.43	1.02
<b>Z</b>	52.98	404.85	36.75	18.85	0.00	5.10	0.00	0.47	1.02

### Other Probe Parameters

<b>Sensor Arrangement</b>	<b>Triangular</b>
<b>Connector Angle (°)</b>	<b>16.7</b>
<b>Mechanical Surface Detection Mode</b>	<b>enabled</b>
<b>Optical Surface Detection Mode</b>	<b>disable</b>
<b>Probe Overall Length</b>	<b>337mm</b>
<b>Probe Body Diameter</b>	<b>10mm</b>
<b>Tip Length</b>	<b>9mm</b>
<b>Tip Diameter</b>	<b>2.5mm</b>
<b>Probe Tip to Sensor X Calibration Point</b>	<b>1mm</b>
<b>Probe Tip to Sensor Y Calibration Point</b>	<b>1mm</b>
<b>Probe Tip to Sensor Z Calibration Point</b>	<b>1mm</b>
<b>Recommended Measurement Distance from Surface</b>	<b>1.4mm</b>