

# THEOS Kit

User Manual

English

## **Preface**

Thank you for using this product. In order to use this product better and safer, please read the user manual carefully.

## **Scope Of Application**

This user manual is suitable for the THEOS wireless pocket microphone system of Shenzhen Aputure Innovation Technology Co., Ltd. (hereinafter referred to as Aputure), and describes its external dimensions, characteristics, technical requirements and precautions.

THEOS wireless pocket microphone system is a wireless pocket microphone system specially designed for film and television recording and shooting. It can provide stable wireless audio transmission and anti-interference ability in various environments and conditions, and is suitable for complex environments and multi-person use occasions. Full metal jacket is adopted with compact and portable design, which is easy to carry and install, simple and easy to use.

# Contents

<b>Important Hint.....</b>	<b>04</b>
<b>FCC Conformity Statement.....</b>	<b>05</b>
<b>FCC Radiation Exposure Statement.....</b>	<b>06</b>
<b>List of Articles.....</b>	<b>06</b>
<b>Introduction.....</b>	<b>08</b>
<b>Installations And Use.....</b>	<b>11</b>
<b>DBTX function operations.....</b>	<b>11</b>
Button Functions.....	11
Antenna Installation.....	11
Lavalier Microphone Installation.....	11
Battery Installation.....	12
Insert-and-replace Micro SD Card.....	12
Read The Audio Files.....	12
Installation Of Belt .....	13
Definition Of LED Indirector.....	13
<b>D2RX Functions And Operation.....</b>	<b>14</b>
Button Functions.....	14
Antenna Installation.....	14
Battery Installation.....	15
Installation Of Belt.....	15
Installation Of Removable Cold Shoe Mount.....	16
Definition Of LED Indicator.....	16
Connecting To Recording Devices.....	17
Recommended Antenna Installation Angle.....	18
<b>Device Activation.....</b>	<b>19</b>
<b>Frequency Settings.....</b>	<b>21</b>
<b>DBTX Interface Function Operation.....</b>	<b>25</b>
DBTX main screen interface.....	25
FREQ.....	28
GAIN.....	29

LEVEL.....	29
TC SYNC.....	29
REC MODE.....	30
RF POWER.....	30
LOW CUT.....	31
DID.....	31
FILE.....	31
LED .....	31
MONITOR.....	32
BT.....	32
BATTERY.....	33
SYSTEM.....	33
<b>D2RX Interface Function Operation.....</b>	<b>39</b>
D2RX main screen interface.....	39
D2RX gain shortcut key operation.....	39
MONITOR.....	40
MENU.....	40
RF SET.....	40
FREQ.....	40
SCAN.....	41
SPARE.....	42
MANUAL.....	43
COLOR.....	43
OUT TYPE.....	44
LEVEL.....	45
DID.....	46
BT.....	47
BATTERY.....	48
SLEEP .....	48
SYSTEM.....	49
<b>DBTX specifications and parameters.....</b>	<b>51</b>
<b>D2RX specifications and parameters.....</b>	<b>53</b>

## Important Hint

- Please read this product manual carefully.
- Keep this product manual. Always include this product manual when passing the products on to third parties.
- Heed all warnings and follow all instructions in this product manual.



Warning: Do not place the product near any corrosive chemicals. Corrosion may cause the product to malfunction.

- Only use a microfiber or dry cloth to clean the product.
- Operate carefully - dropping or hitting the product may cause damage.
- Keep all liquids away from the product. Liquids entering the product can short-circuit the electronics or damage the mechanics.
- Store the product in a dry, clean, dust-free environment.
- Please contact authorized maintenance personnel when maintenance is needed. There are precise electronic circuits in this product. Failure caused by unauthorized disassembly is not covered by our warranty, but users can pay for maintenance.
- This product has been certified by CE, RoHS, UKCA, FCC, KC and NCC, etc. Please adhere to the operation standards. The warranty does not cover repairs arising out of the misuse of the product, although you may request such repairs on a chargeable basis.
- The instructions and information in this manual are based on thorough, controlled company testing procedures. Further notice will not be given if the design and specifications change.
- DEITY AA batteries are disposable lithium iron non-rechargeable batteries, please do not charge them.

## FCC Conformity Statement

This device complies with part 15 of the FCC rules. Operation is subject to the following two conditions:

(1) This device may not cause harmful interference, and(2) This device must accept any interference received, including interference that may cause undesired operation. Warning: Changes or modifications not expressly approved by the party responsible for compliance could void the user's authority to operate the equipment. NOTE: This equipment has been tested and found to comply with the limits for a Class B digital device, pursuant to part 15 of the FCC rules. These limits are designed to provide reasonable protection against harmful interference in a residential installation. This equipment generates, uses and can radiate radio frequency energy and, if not installed and used in accordance with the instructions, may cause harmful interference to radio communications. However, there is no guarantee that interference will not occur in a particular installation. If this equipment does cause harmful interference to radio or television reception, which can be determined by turning the equipment off and on, the user is encouraged to try to correct the interference by one or more of the following measures:

- Reorientate or relocate the receiving antenna.
- Increase the distance separating the equipment and receiver.
- Connect the device to a different power supply than that which the receiver is connected to.
- Consult the dealer or an experienced radio/TV technician for help.

# FCC Radiation Exposure Statement

The device has been evaluated to meet general RF exposure requirements. The device can be used in portable exposure condition without restriction.

## List Of Articles

Package includes the following items:

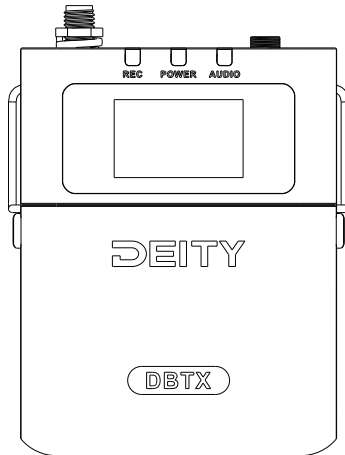

DBTX (2 pcs)

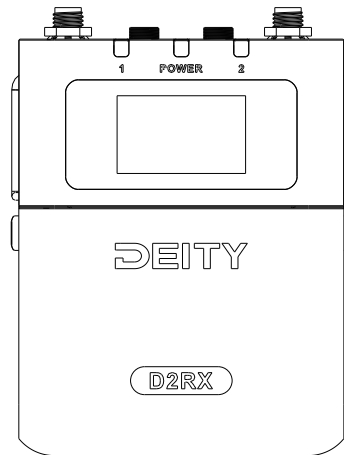

D2RX (1 pc)

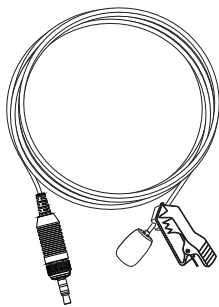

3.5mm TRS W.Lav Pro (2 pcs)

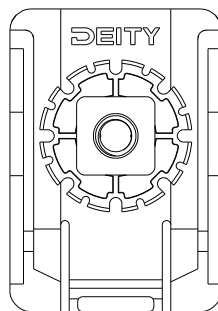

Removable Cold Shoe  
Mount (1 pcs)

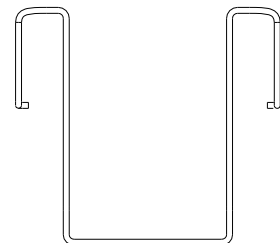

Belt clip (3 pcs)

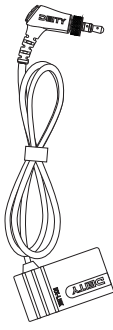

RX Link (2 pcs)

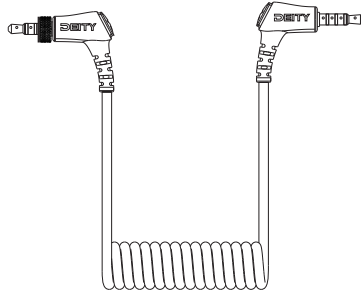

C12 Cable (1 pc)

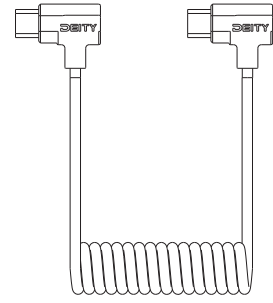

USB-C to USB-C Cable (1 pc)

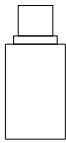

USB-C to USB-A Firmware  
Update Adapter (1 pc)



DEITY AA battery (3 pcs)

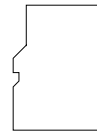

Micro SD card (2 pc)



SMA Antenna (UHF-TA)  
(the qty and length of  
antennas are different in  
different regions.)



SMA Elbow Antenna (UHF-RA)  
(the qty and length of  
antennas are different in  
different regions.)



# Introduction

## Nomenclature

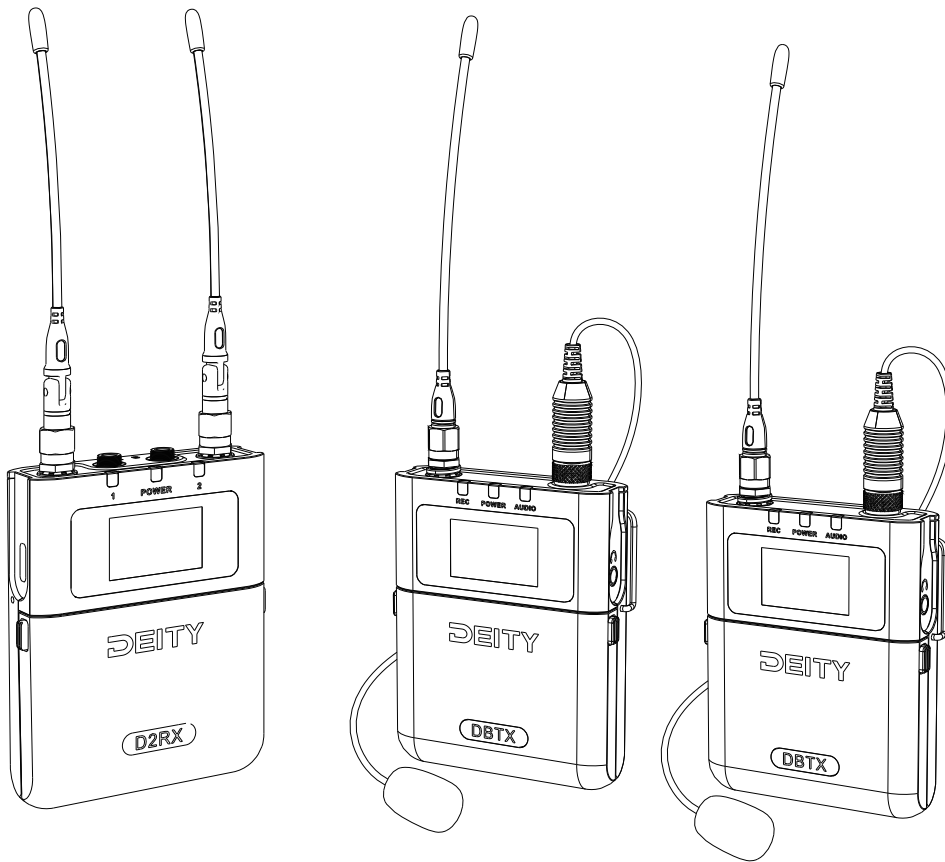

## D2RX

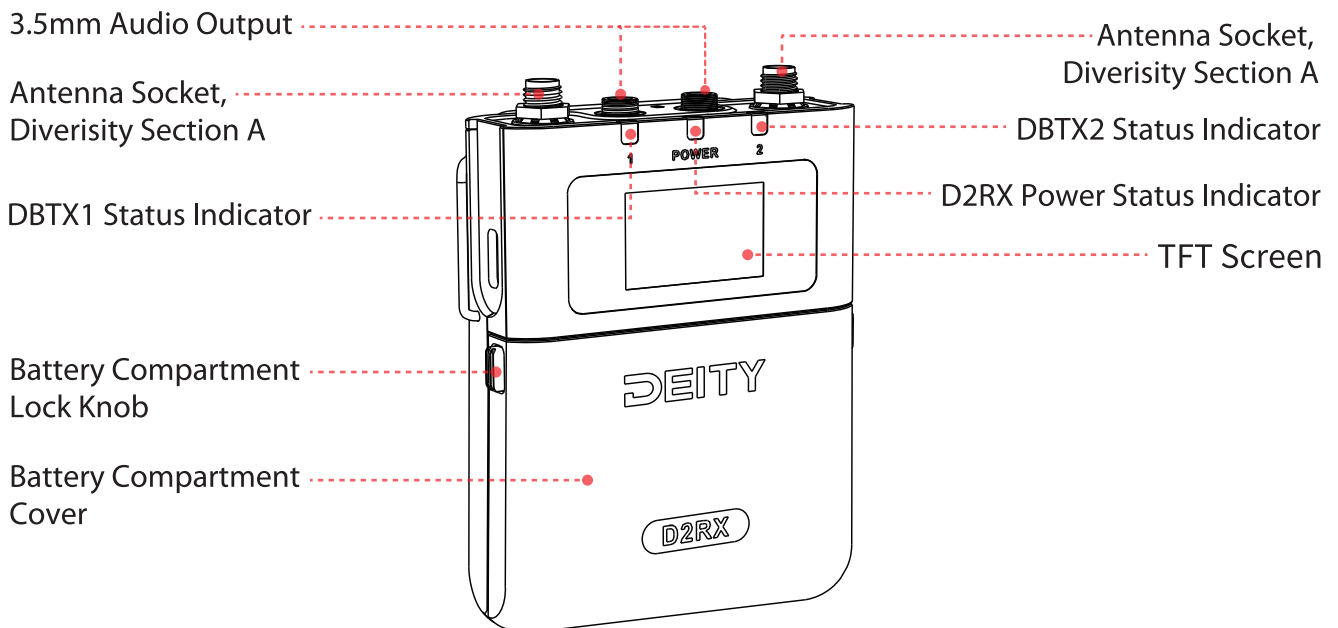

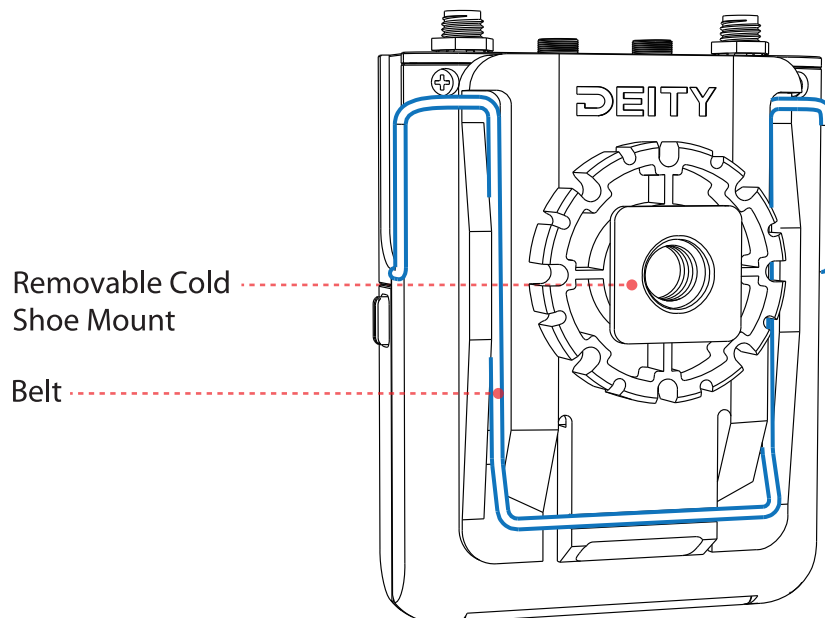
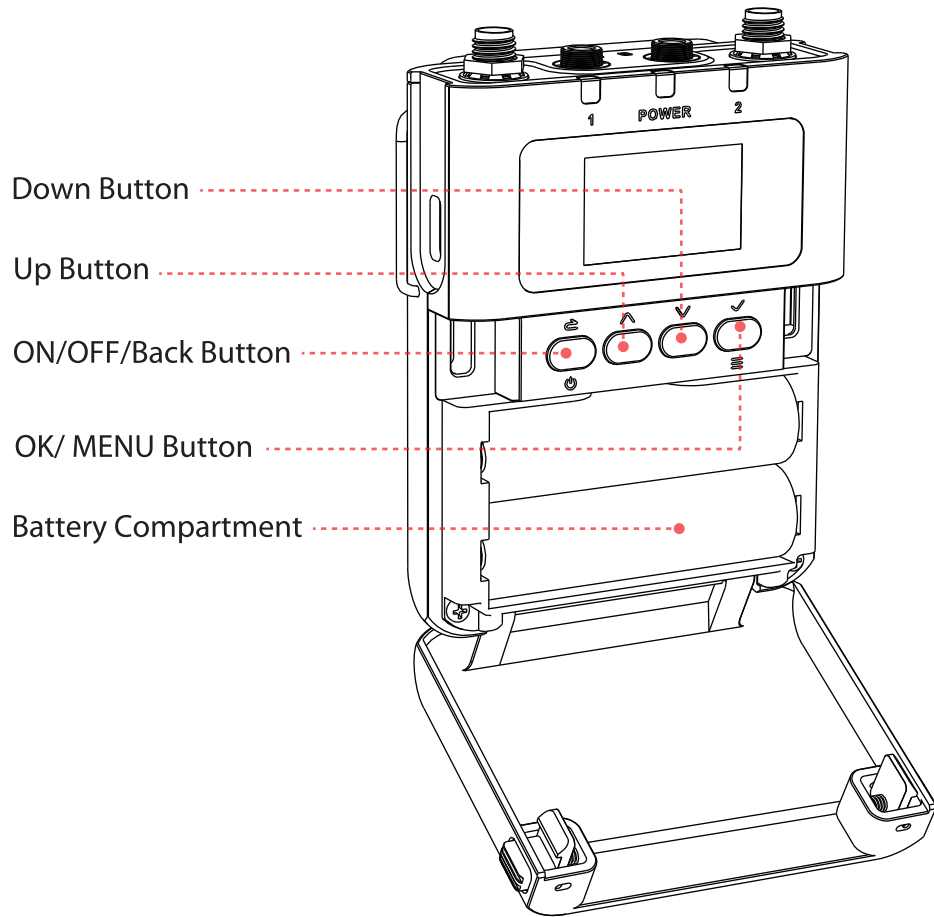

# DBTX

Antenna Socket

3.5mm Audio Input

TFT Screen

Battery Com-  
partment Lock  
Knob

Battery  
Compartment  
Cover

Belt

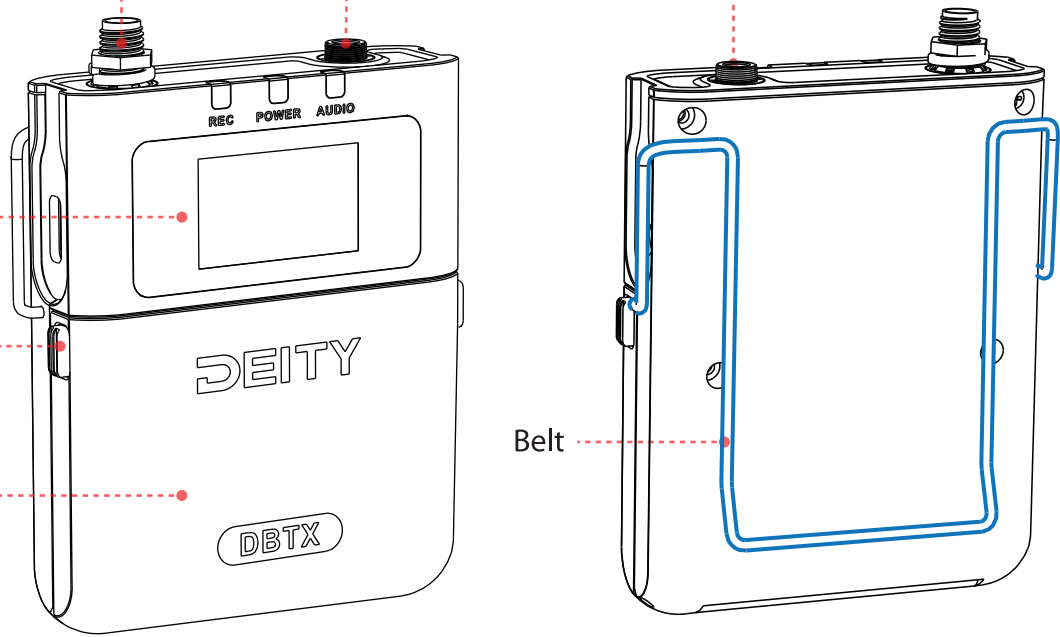

Down Button

Up Button

Switch On /Off  
/Back/Mute

OK /MENU Button

Battery Compartment

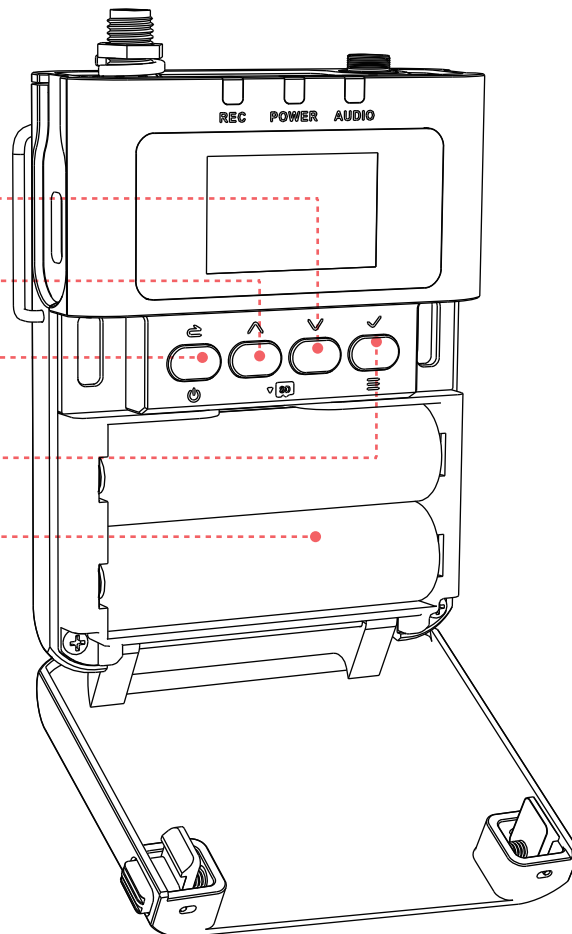

# Installations And Use

## DBTX function operations

### Button Functions

**On/OFF/Back Button:** long press to turn the DBTX on and off, It also functions as a “back” button while navigating the various menus and setup screens to return to the previous screen or menu item.

**Up /Down Button:** The Up and Down buttons are used to select various options and adjust values in the setup screens. long press UP bottom to enter the recording interface. Long press the Down button to enter timecode setting interface.

**OK /MENU Button:** This button is used to enter the menu and select highlighted items or enter menu interface.

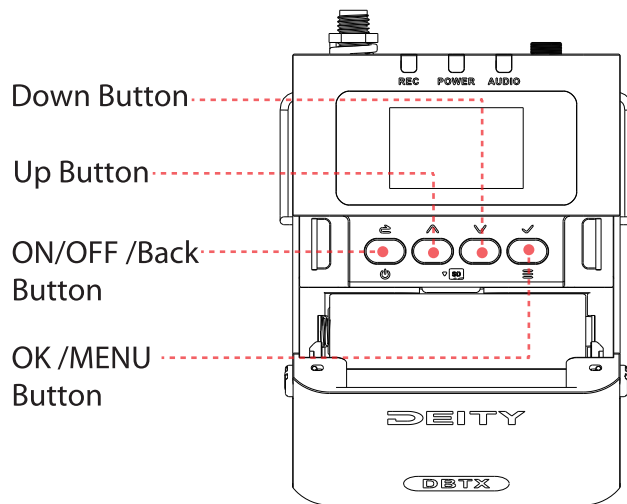

### Antenna Installation

Rotate and install the matching antenna on the antenna socket on the upper part of DBTX, and then tighten and fix it to complete the installation of the antenna.

The antenna of DBTX is a whip antenna with SMA interface.

### Lavalier Microphone Installation

DBTX has a locking 3.5mm TRS connection. Simply clip the Lavalier Microphone onto your clothes and screw it into the DBTX TRS microphone input.

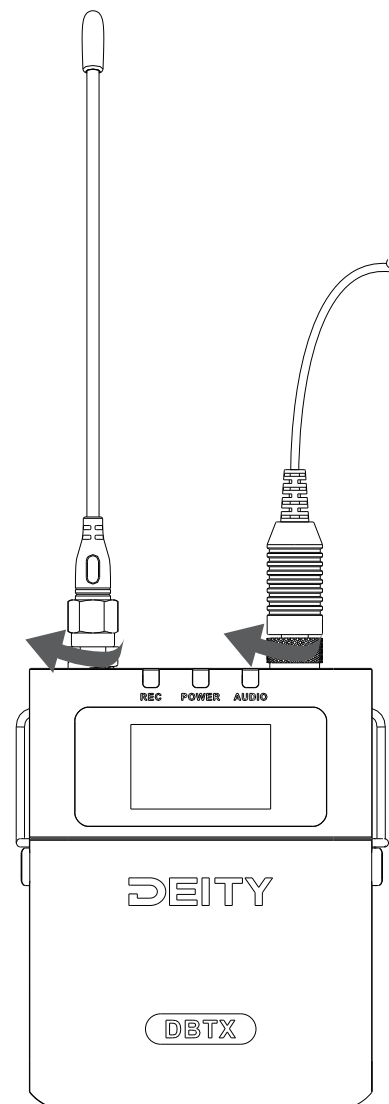

## Battery Installation

Press the battery compartment lock/ unlock keys that located at both sides of DBT at the same time, open the battery compartment cover and install the AA battery into the battery compartment with right directions.

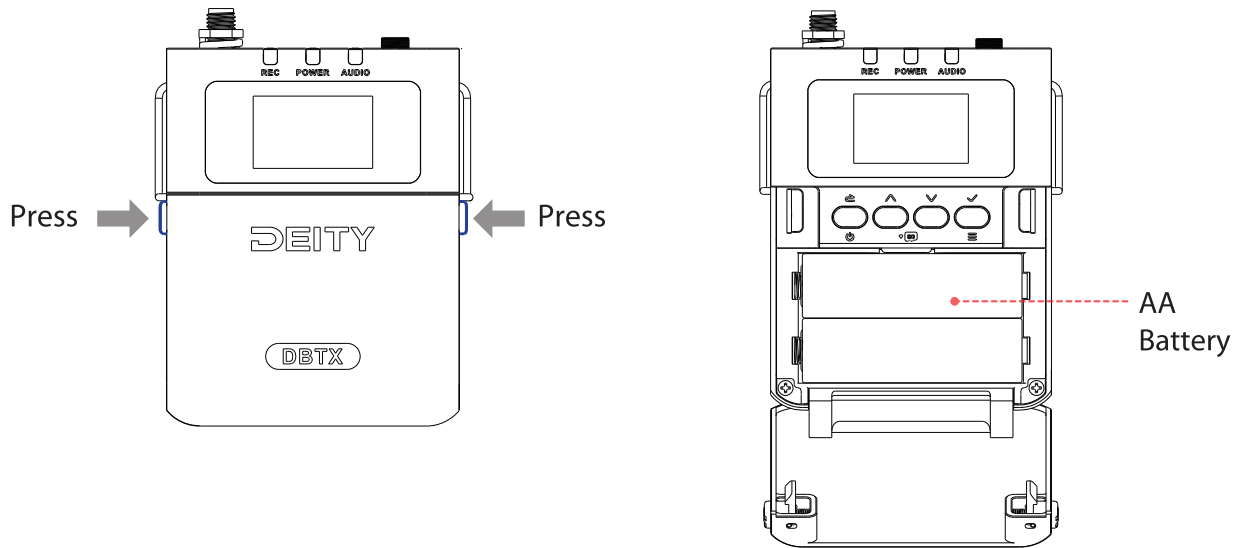

## Insert-and-replace Micro SD Card

The micro SD card need to be located at the upper part of the battery compartment of DBTX. Open the battery compartment cover and directly insert the micro SD card into the card slot before install the AA battery. If the battery has been installed, it is needed to remove the battery.

## Read The Audio Files

You can power on the DBTX by using included USB-C to USB-C cable connected to a DC adapter (not included). If you want read and download the audio file from micro SD card through USB-C port, you need to enter to come to main interface and enter "SYSTEM" to select the READER model .

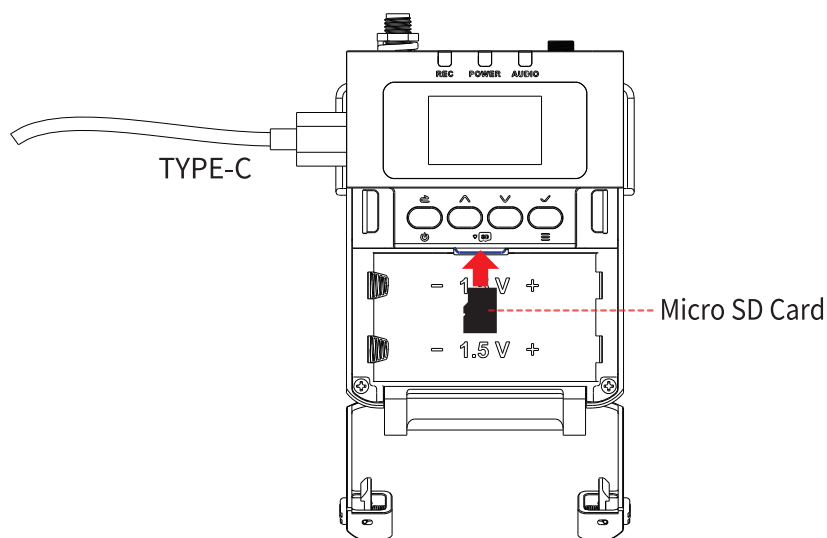

## Installation Of Belt

Insert belt into the installation holes on both sides of the DBTX.

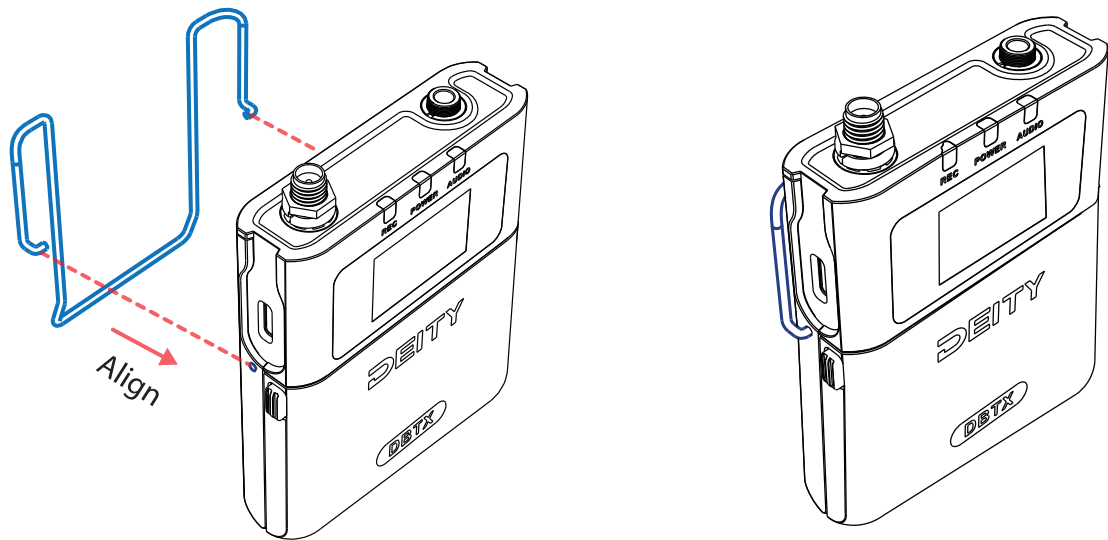

## Definitions Of LED Indicator

**(REC) Led indicator:** When recording, the REC led stays red.

**(POWER) Led indicator:** The power led glows green when the battery is good. The color changes to red when there is about 30 minutes of operation left.

**(AUDIO) Volume indicator:** Display the brightness and color of the indicator light according to the current volume level. The light color corresponds to the volume value of the screen level meter. When the volume is -40dB~-10dB, it displays a green light. When the volume is -10~0dB, it displays a red light. When the microphone is set to mute, the red light flashes slowly.

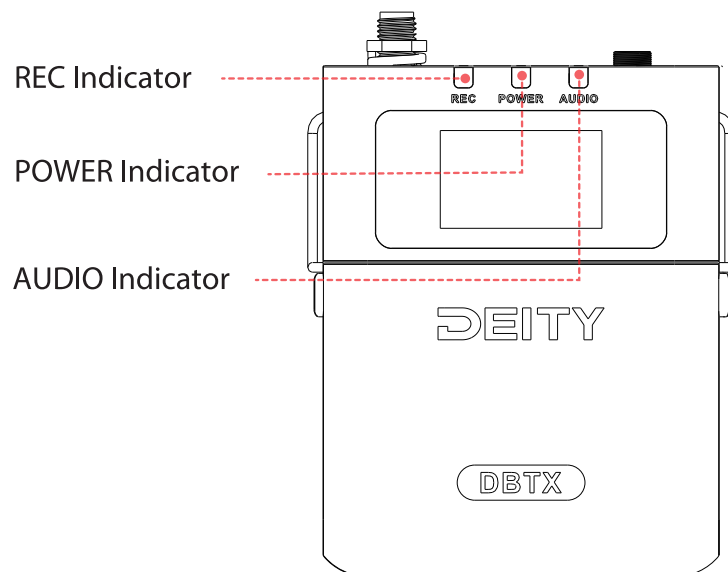

## D2RX Functions And Operation

### Button Functions

**On/OFF/Back Button:** long press to turn the D2RX on and off, It also functions as a “back” button while navigating the various menus and setup screens to return to the previous screen or menu item.

**Up /Down Button:** The up and down buttons are used to select various options and adjust values in the setup screens. Long press up bottom to enter the gain setting of channel A. Long press the down button to enter enter the gain setting of channel B.

**OK /MENU Button:** This button is used to enter the menu and select highlighted items or enter menu interface.

(When out B is selected as monitor mode, short press up/down to directly adjust the monitoring volume)

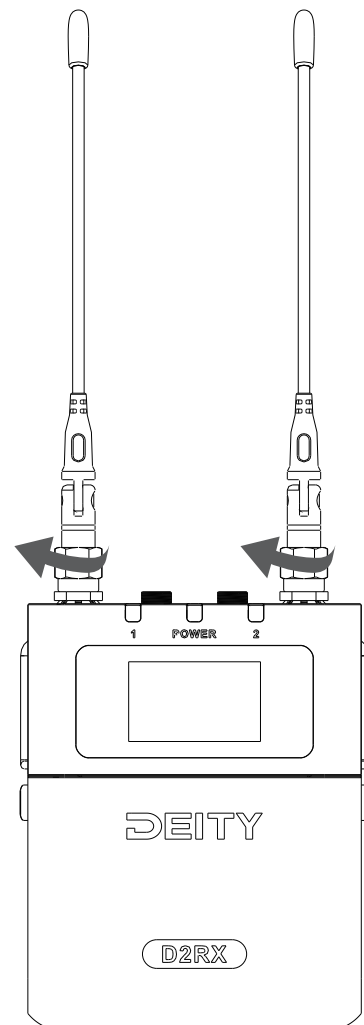
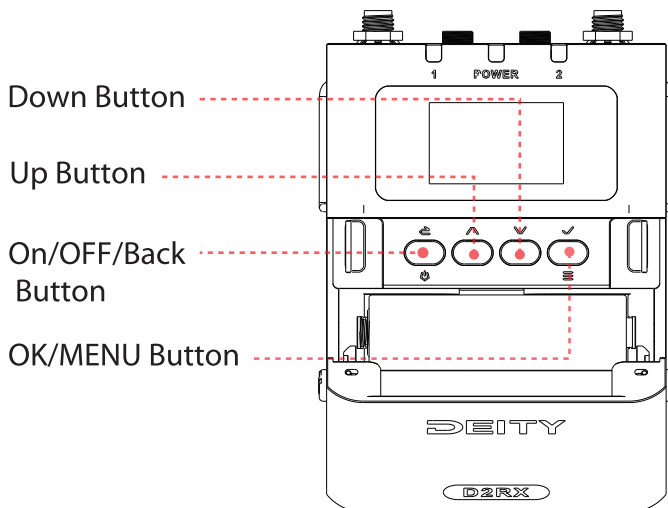

### Antenna Installation

Simply screw the sma elbow antenna into the D2RX antenna socket.

## Battery Installation

Press the battery compartment lock/ unlock knob that located at both sides of DBTX at the same time, open the battery compartment cover and install the AA battery into the battery compartment in the right directions.

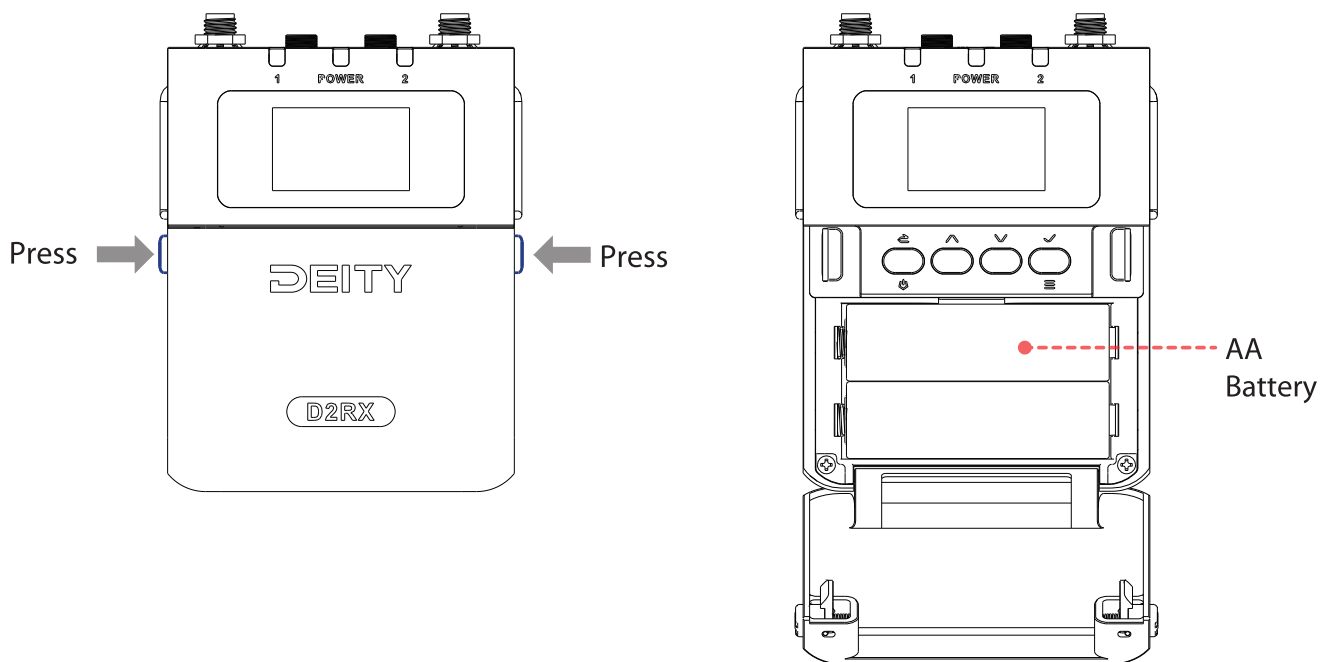

## Installation Of Belt

Insert back clip into the installation holes on both sides of the D2RX.

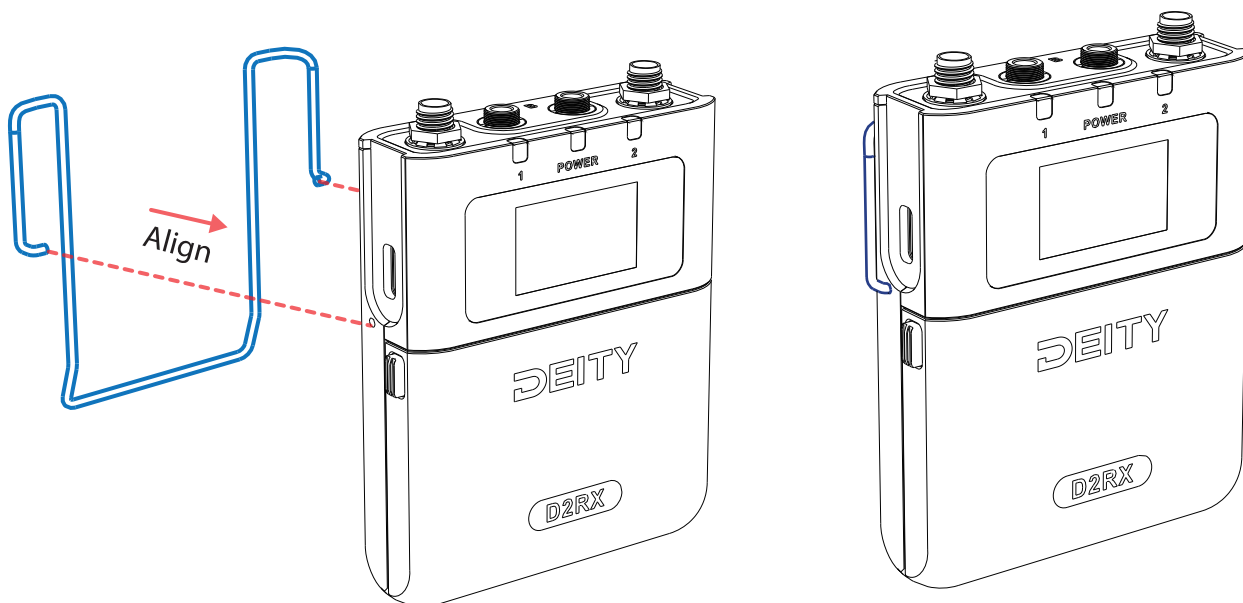



## Installation Of Removable Cold Shoe Mount

After back clip is installed, slide the cold shoe mount slide into the back clip from top to bottom, when you heard "click", it is fixed well.

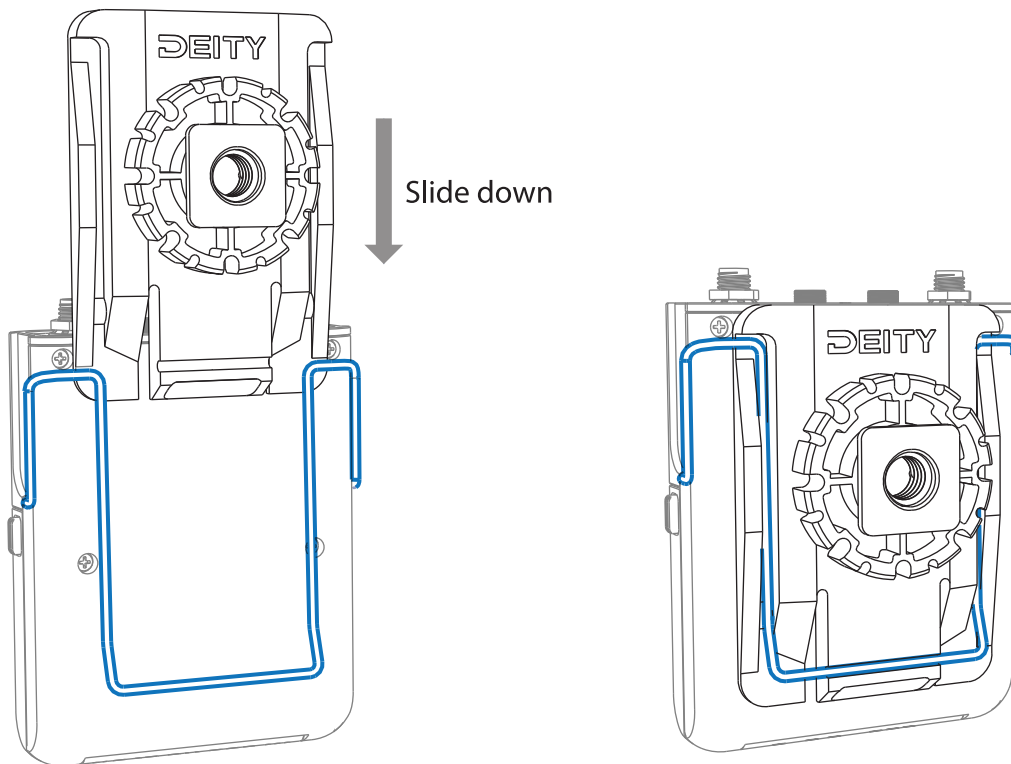

## Definition Of LED Indicator

**(AUDIO) Volume Indicator:** Display the brightness and color of the indicator light according to the current volume of the wireless transmitter. The light color corresponds to the volume value of the VU meter on the screen. When the volume is  $-40\text{dB} \sim -10\text{dB}$ , it displays a green light. When the volume is  $-10 \sim 0\text{dB}$ , it displays a red light. When the microphone is set to mute, the red light flashes slowly.

**(POWER) Led Indicator:** The power led glows green when the battery is good. The color changes to red when there is about 30 minutes of operation left.

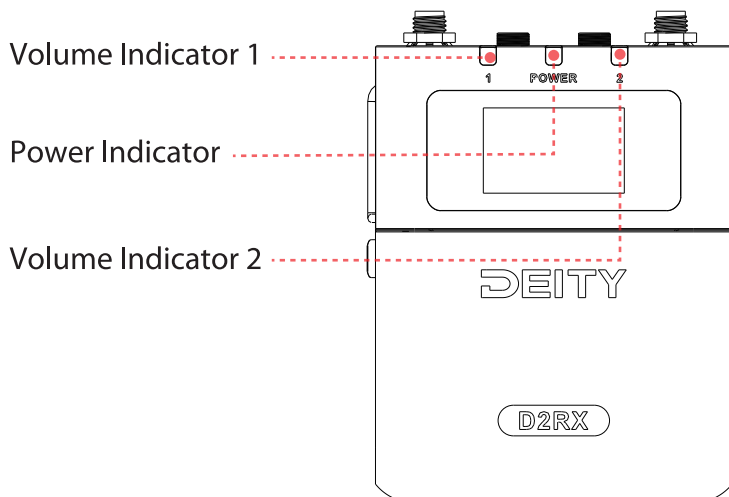

## Connecting To Recording Devices

The THEOS can be used with most of recording devices: cameras, audio recorders, smart phone and more. You can use included deity C 12 cable to connect camera, RX link to connect recorders and USB-C to USB-C to PC or smart phone.

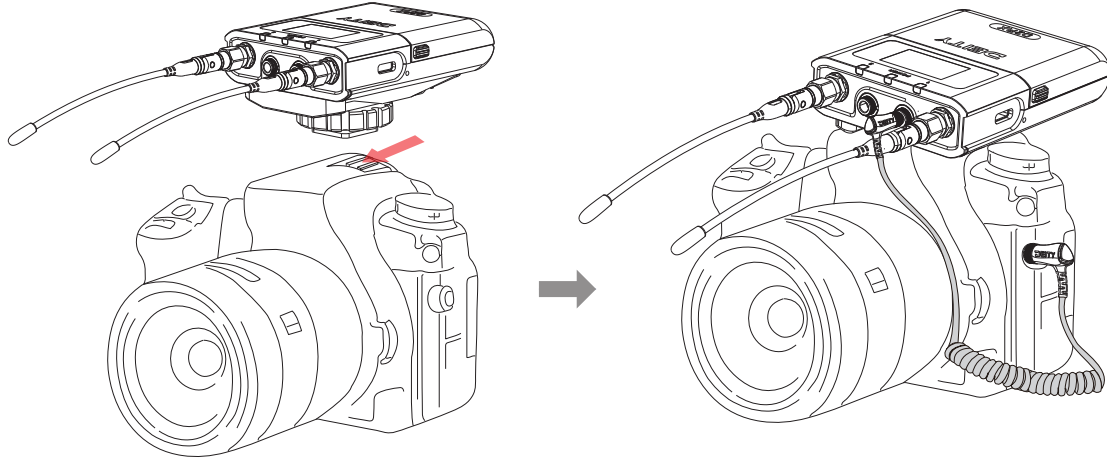

**Connection to camera**

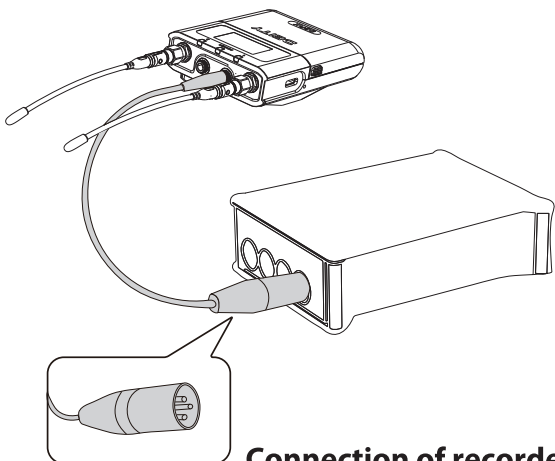

**Connection of recorder**

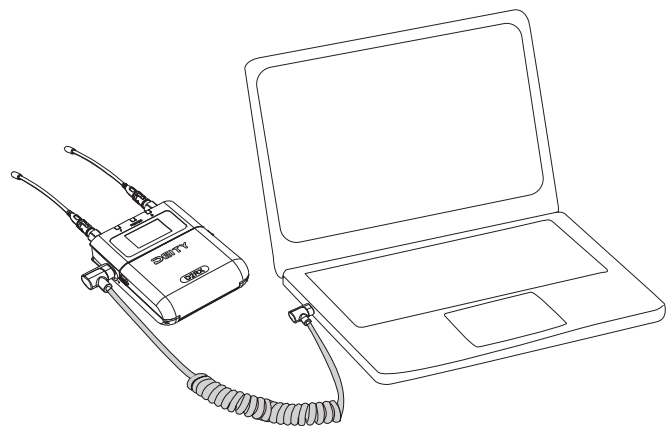

**Connection of computer**

## Recommended Antenna Installation Angle

It is recommended that users separate the antenna angles by more than 90° to reduce interference and maintain the stability of connection and communication.

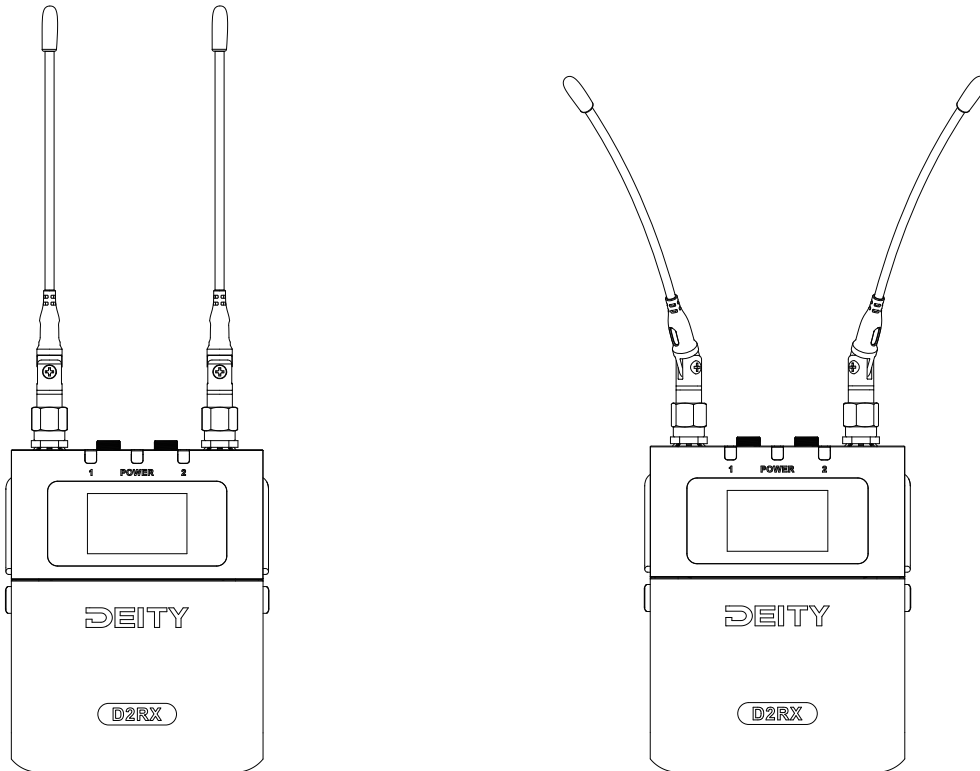

## Unrecommended antenna installation angle

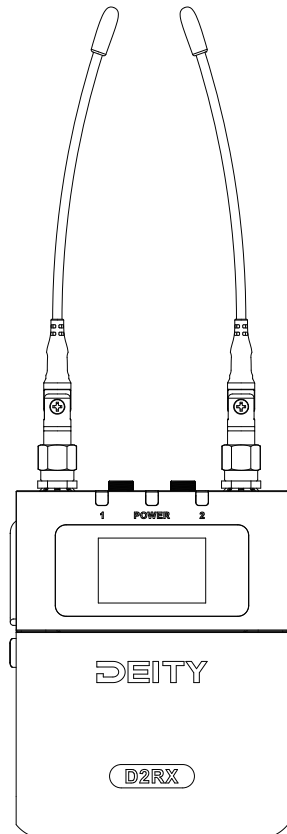

## The wrong way to use the antenna

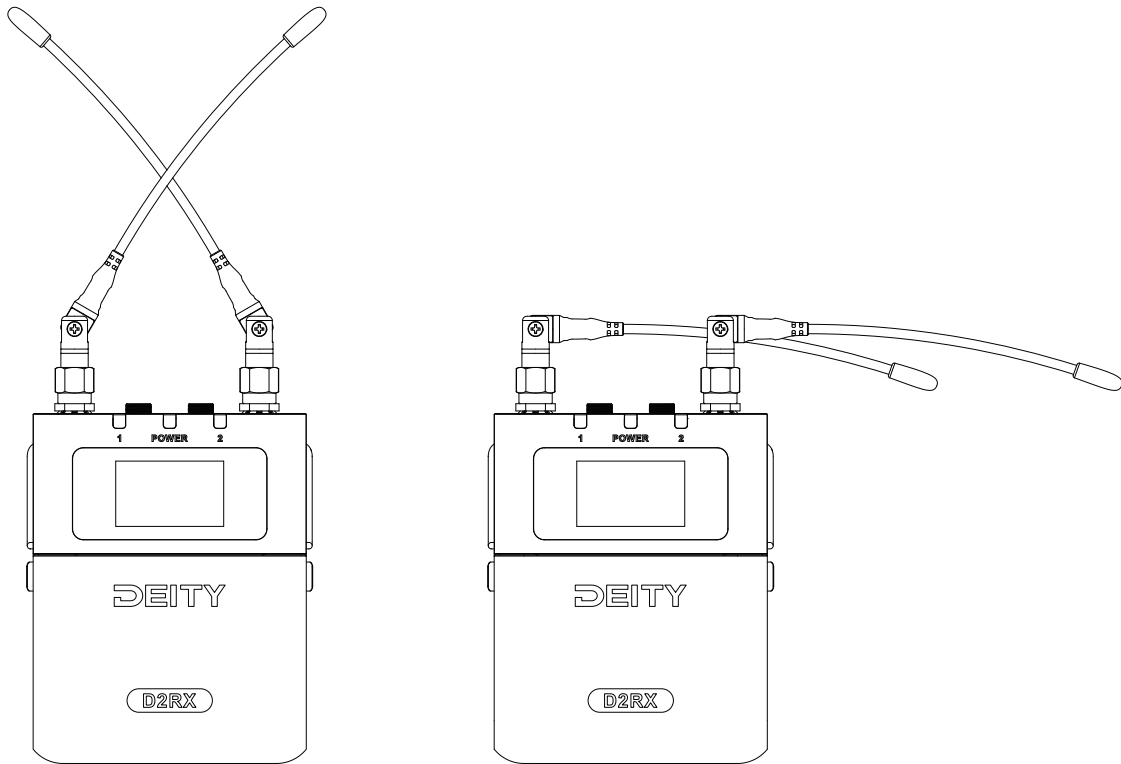

## Device Activation

This activation procedure only applies to THEOS global version

When purchasing the THEOS global version, and DBTX and D2RX are turned on for the first time, THEOS device needs to be connected to the mobile phone APP “Sidus Audio” to complete activation. The device screen will prompt sidus audio software to download the QR code. If you have downloaded the software, you can open the sidus audio software, and add DBTX and D2RX to the device list by adding devices. Sidus audio will jump to the activation interface, and the software will allocate the local legal frequency band to the device according to the positioning information of your local mobile phone location. After successful allocation, the device can be activated to start using. If you don't turn on the mobile phone location authority, the software will not be able to allocate correct and legal frequency band information to the device, and THEOS will not be used normally.

When adding a new device to the sidus audio software while the device cannot be searched, select the BT RESET button on the device screen and click the oK button to reset the bluetooth settings of the device. After the reset is successful, connect to the software normally.

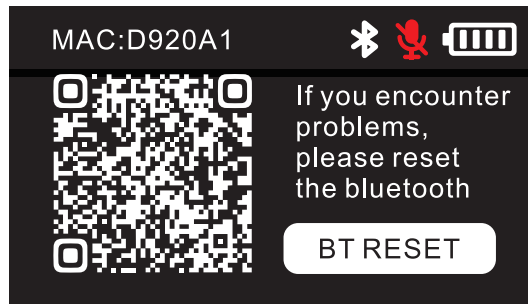

Set up a device network: After turning on the bluetooth switch of the mobile terminal and resetting the bluetooth of the offline audio device, click the add button **+** under the navigation bar of all devices in the app, and the app will search for and display nearby pairable devices. After the user selects the target device independently, click the "Configure" button to form a device network. After the user successfully completes the network operation, Sidus Audio App can identify the device to be activated and prompt to enter the device activation interface. The user can choose whether to activate the device. If the device is activated, the software will determine the local legal frequency band according to the current location information of the mobile phone, and the user can enter the device list after selecting the frequency band according to the needs. After the network is established successfully, the sidus audio app will prompt whether to automatically allocate frequency point information, and the user can choose to enter directly or select automatic allocation.

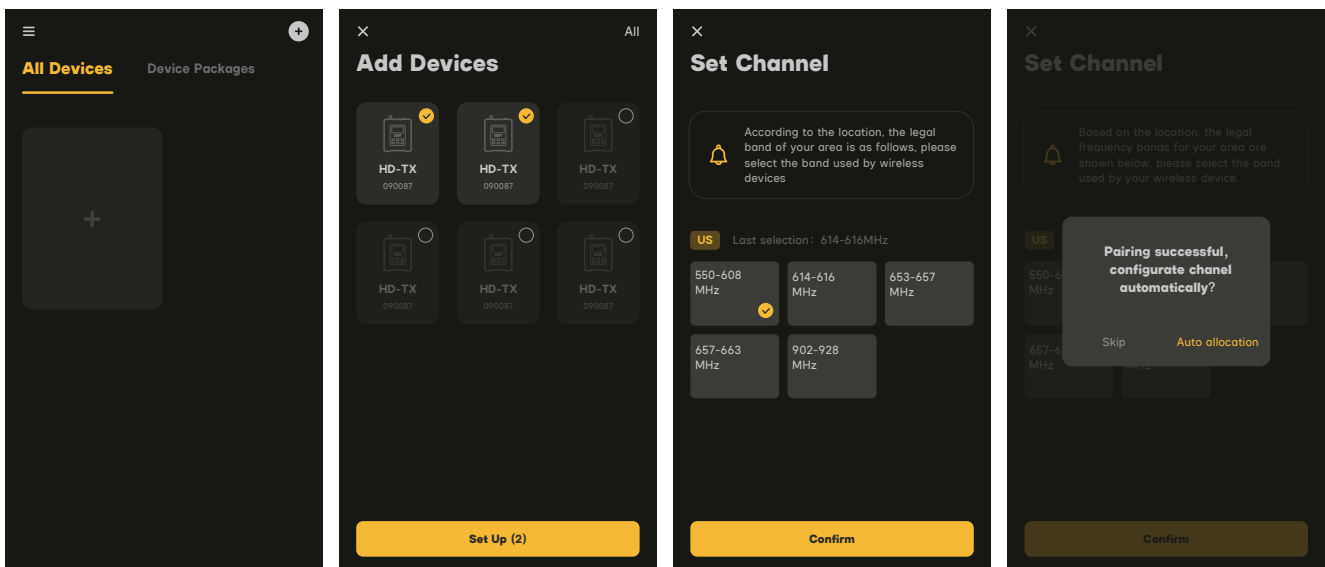

# Frequency Settings

KIT package DBTX and D2RX have been paired successfully by default upon delivery

**Networking mode I of DRTX and D2RX:** DBTX and D2RX need to enter pairing mode at the same time

**D2RX:** Enter the "FREQ" mode through the menu selection in D2RX. After entering, it is needed to select the "MANUAL" manual selection function, and select the channel corresponding to the DBTX you want to pair in this function menu. Click "PAIR" to enter the pairing mode, and "SUCCESS" will be displayed if the pairing is successful. If the pairing fails, "FAIL" will be displayed. If the pairing fails, it is needed to re-pair or check whether the antenna is installed correctly.

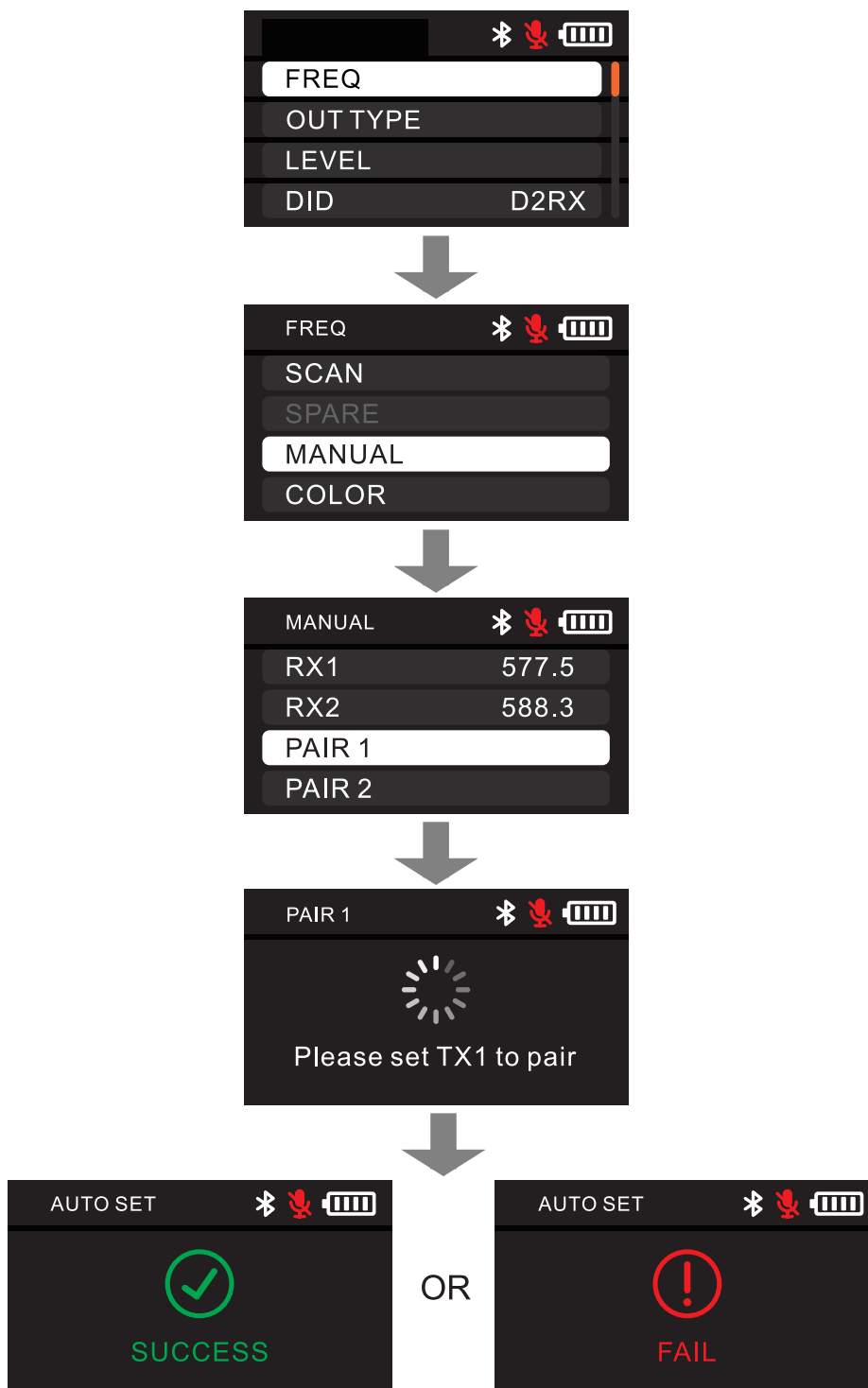

**DBTX:** Select "FREQ" mode through the menu in DBTX, and then enter the pairing mode by selecting PAIR with the up and down keys, and "SUCCESS" will be displayed if the pairing is successful. If the pairing fails, "FAIL" will be displayed. If the pairing fails, it is needed to re-pair or check whether the antenna is installed correctly.

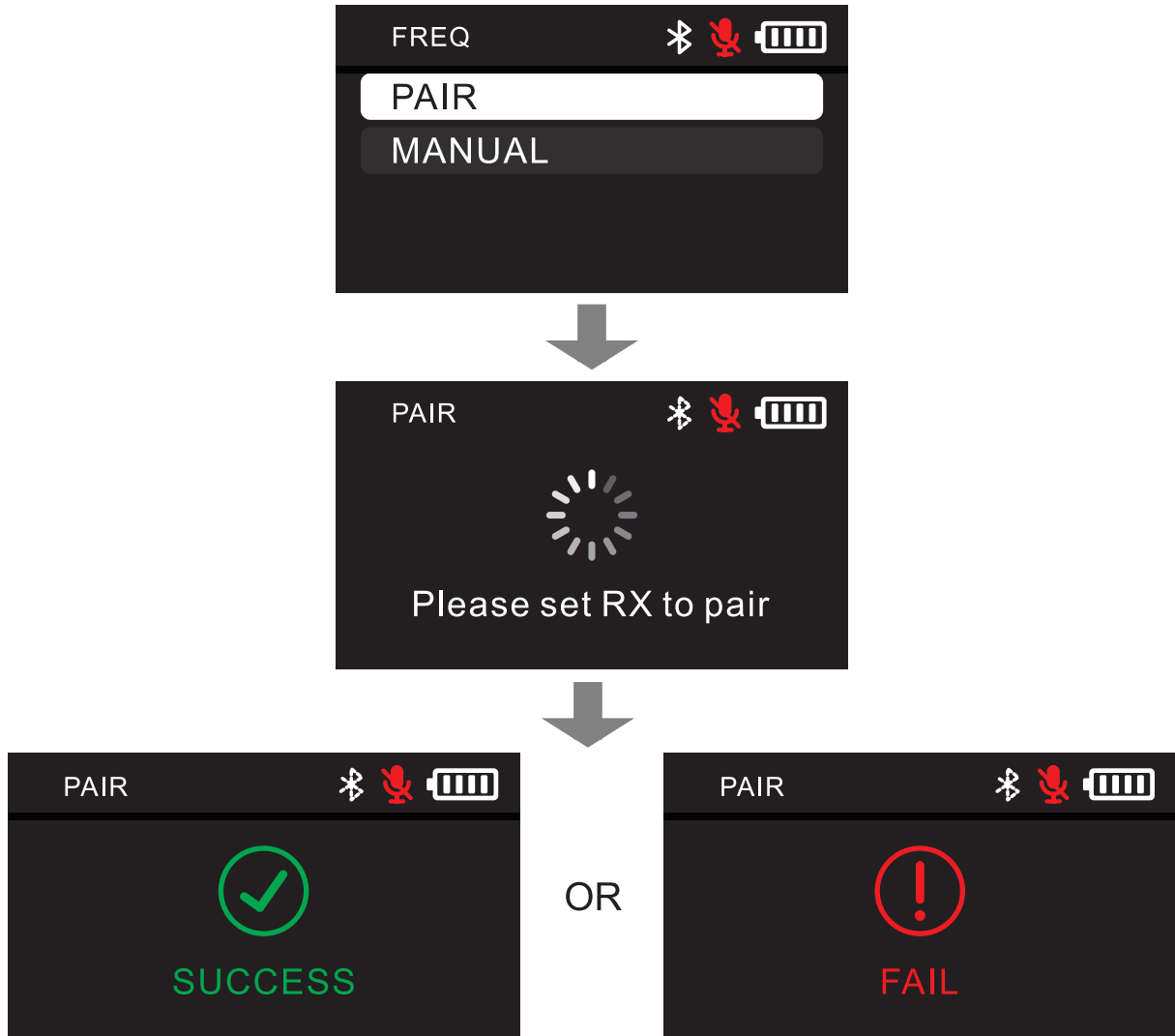

**Networking mode II of DBTX and D2RX:** it is needed to manually set DBTX and D2RX to the same frequency point to complete the pairing networking.

**Networking setting of D2RX:** D2RX needs to enter the "FREQ" mode in the menu, and then select the "MANUAL" setting. By selecting the corresponding channel to be paired, click the "OK" key to modify the frequency point value of the corresponding channel and adjust the value to a clean and available frequency point.

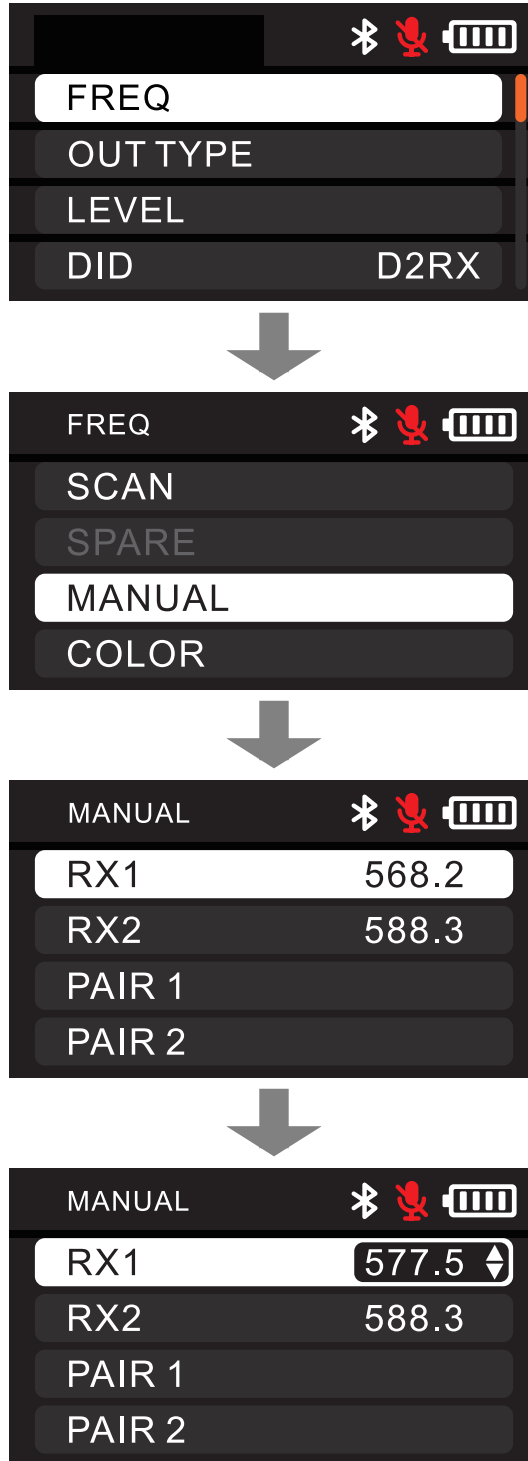



**Networking setting of DBTX:** DBTX needs to enter the “FREQ” mode in the menu, and then select the “MANUAL” setting, and adjust the value by pressing the up and down keys. Short press the up or down key to realize the fine adjustment of 0.1MHz in the frequency point, long press the up or down key to actually adjust the frequency point value quickly, and adjust the frequency points of the wireless frequency point and the corresponding channels of D2RX to the same value, and then complete the pairing networking.

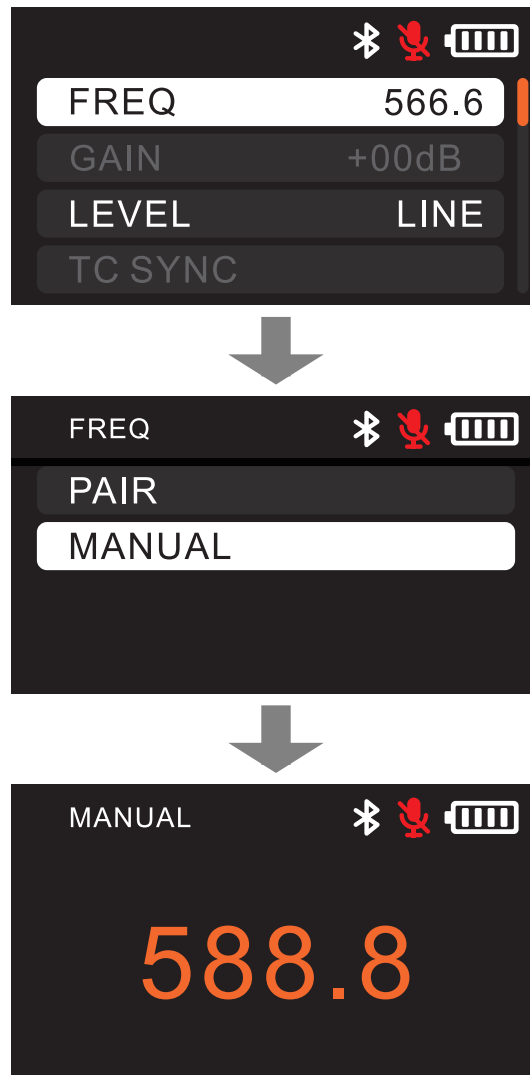

# DBTX Interface Function Operation

## DBTX main screen interface

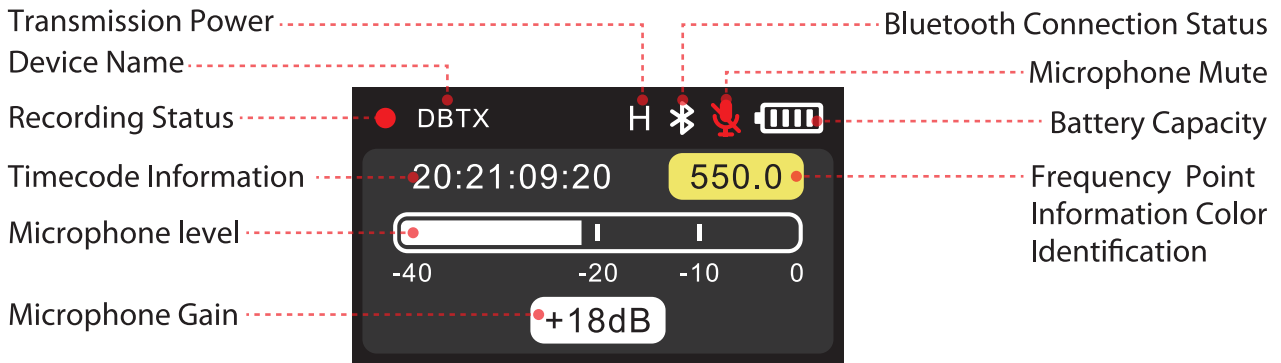

## Recording

Long press the "up arrow key" to enter the recording interface. Click the OK button to start recording audio; click the OK button in the recording state to jump to the prompt to confirm the end of the recording, click OK to end the recording.

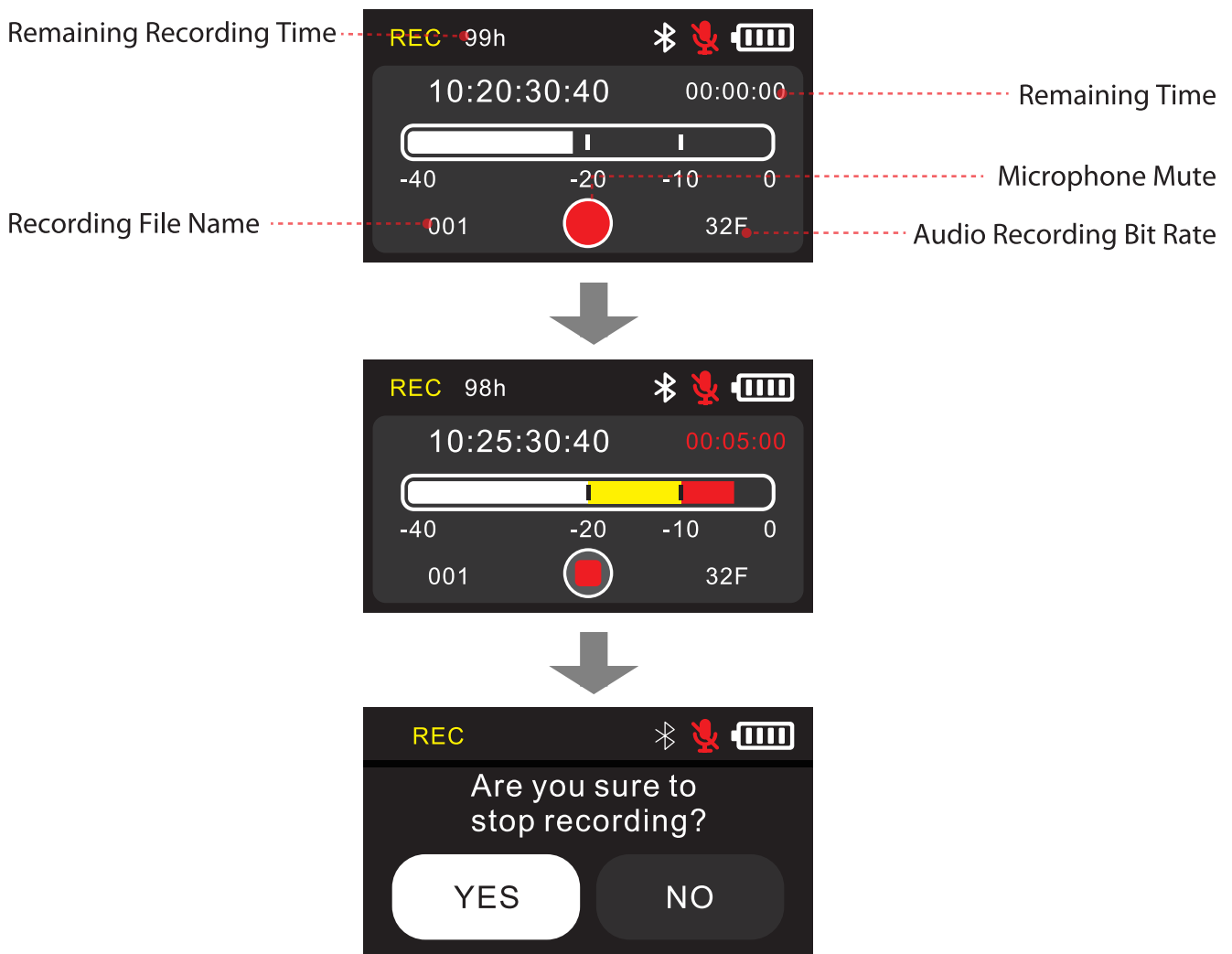

## Timecode setting

Long press “Down button” to enter the timecode interface, and “EXT” displays external timecode data when connecting external timecode device.

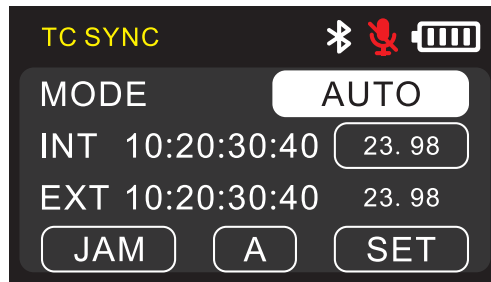

Under the MODE option, you can set the timecode mode, and you can choose “OFF”, “AUTO”, “ONCE” and “FREE” modes.

**OFF:** timecode is off;

**AUTO:** the default setting, which automatically recognizes the wired/wireless timecode for synchronization;

**ONCE:** automatically synchronize the timecode information once and then lock it. After locking, the timecode will not be automatically synchronized again, and the lock will be released by switching modes;

**FREE:** the time information set by the current device is timecode, which does not support Restart timecode and does not accept external timecode signals.

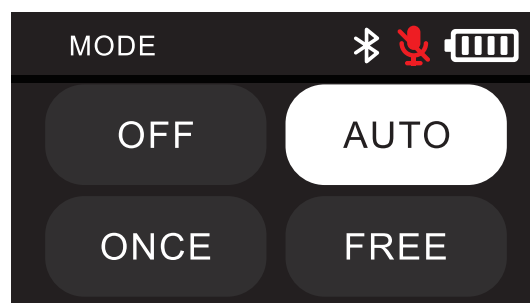

## Timecode frame rate setting

The frame rate of timecode recording, you can set the frame rate as 23.98,24,25,29.97,29.97DF,30 as required. DF stands for dropped frame. The default frame rate of the system is 25, so it is suggested to set an appropriate frame rate in advance.

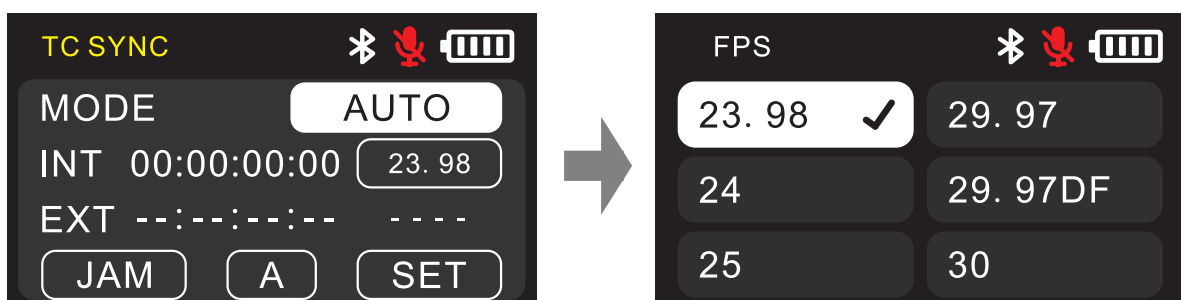

## JAM synchronization

If you don't have a DEITY wireless timecode device around you, you need to synchronize it by cable. In Auto or Jam mode, the device will automatically identify and synchronize the timecode signal of the 3.5mm input port; in Free mode or synchronized JMD mode, the system can recognize external signals.

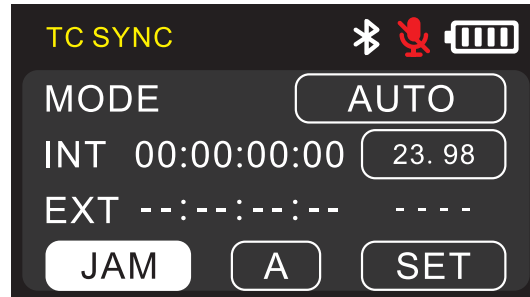

## Timecode channel setting

In order to facilitate your DEITY timecode management, we provide A-H timecode synchronization group, and only devices in the same group can synchronize, except Bluetooth operation synchronization.

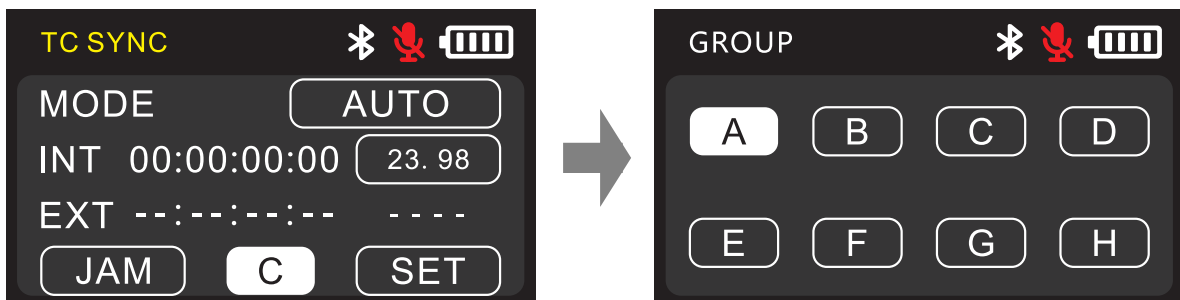

## Timecode data manual adjustment

Select SET to manually customize the starting timecode and start running.

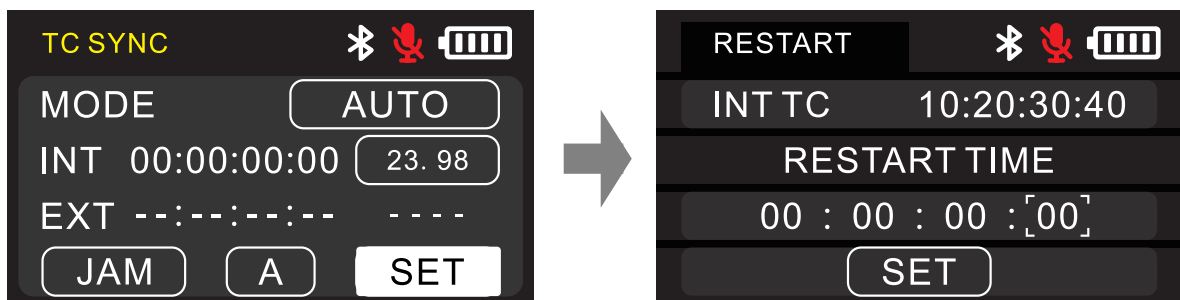

## Menu

Press "Menu key" to confirm.

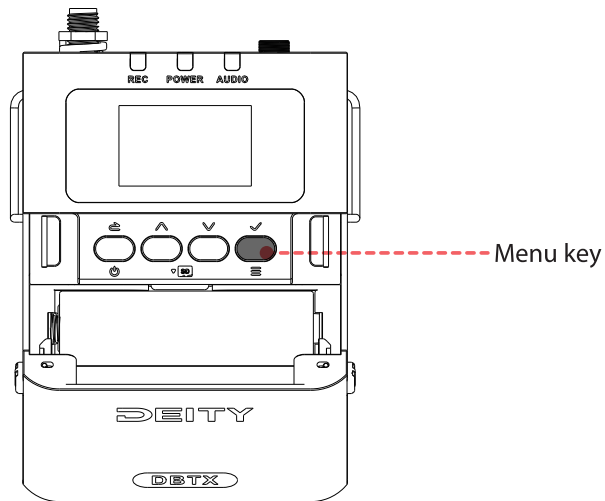

## MENU:

### FREQ

FREQ information can be manually set through FREQ frequency point setting.

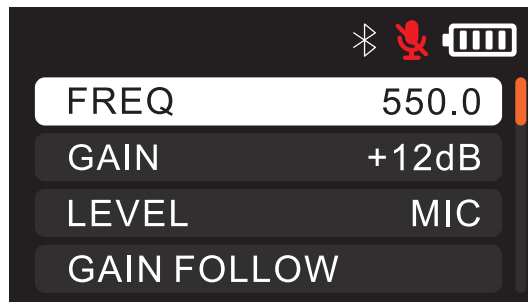

PAIR: When DBTX enters "PAIR", D2RX also enters "PAIR" pairing mode and the device shall pair.

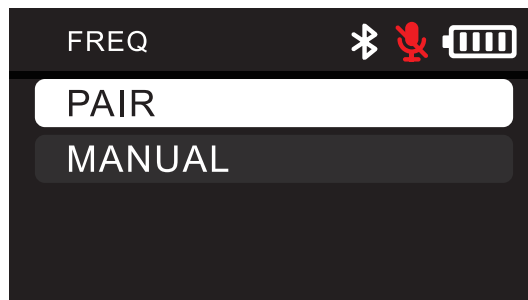

## GAIN

The gain value of microphone input can be adjusted, which can be increased by 30dB at most.

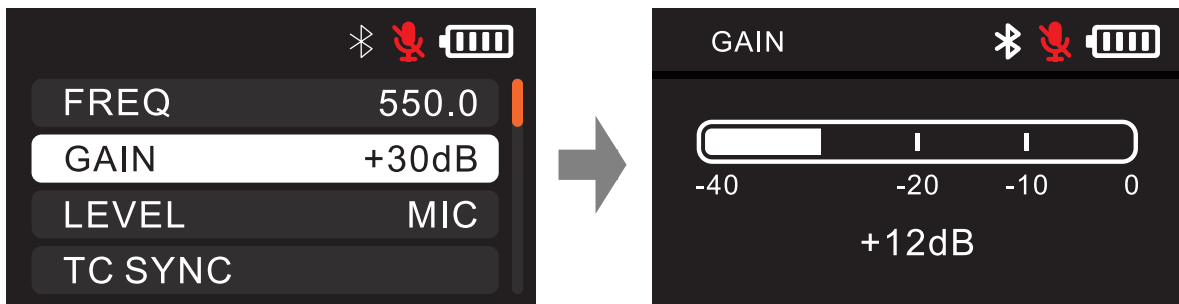

## LEVEL

This mode can manually switch the driving voltage of the microphone. There are two optional states, and the power supply voltage of the microphone can be selected according to the type you need.

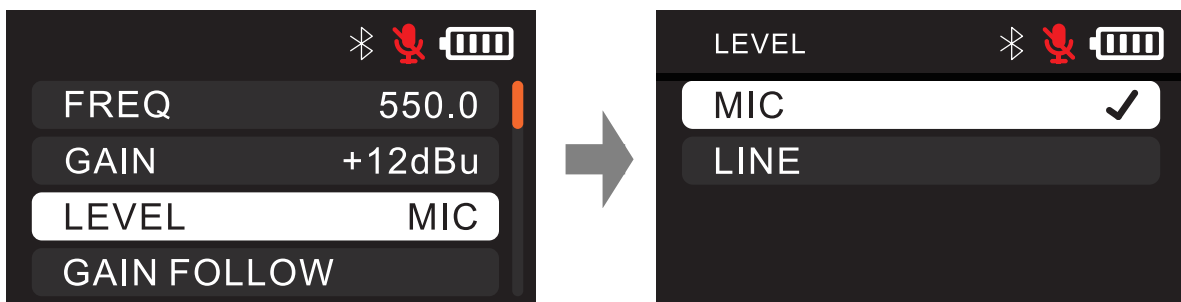

## TC SYNC

Set the timecode and operation mode. Refer to page 26.

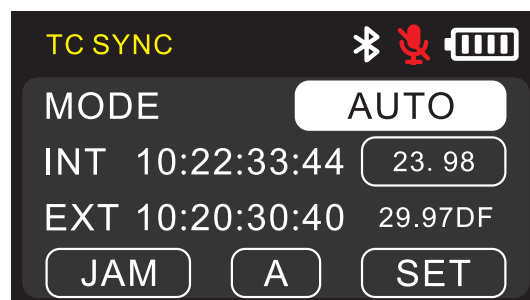

## REC MODE

In this mode, you can adjust the recording parameters and you can set the bitrate of the built-in recording of the memory card: 24-bit and 32-bit float recording.

In this mode, you can also select the default recording status:

Select ALWAYS to start recording automatically after turning on, stop recording and save the recording file automatically after turning off;

Select MANUAL to manually switch the recording status, and the default status is MANUAL.

(When the region is the United States, the RF function and the recording function cannot be used at the same time.)

Select the SYNC REC option to start recording automatically after manual recording + time code synchronization; when the SYNC REC option is turned off, recording will not automatically start after synchronizing the time code; if the device is in the recording state when synchronizing the time code, you need to stop recording first and then adjust the time the code is synchronized, and the recording is not automatically started after synchronization.

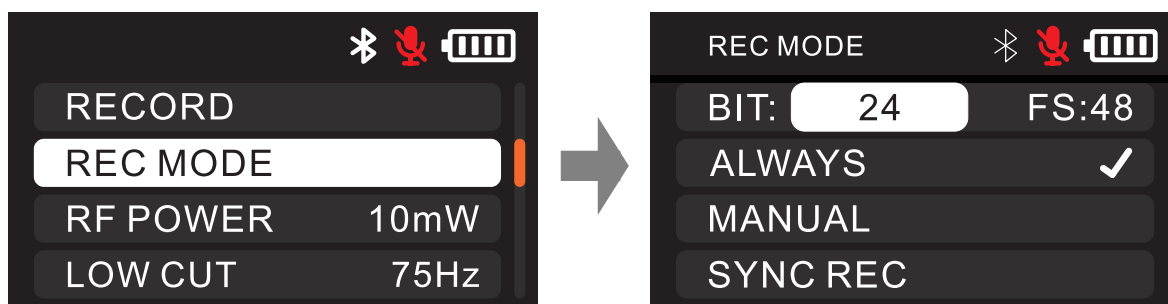

## RF POWER

In this mode, you can choose the power of RF transmission, and the RF power corresponding to the legal frequency band that meets the requirements will be selected as needed.

(When the region is the United States, the RF function and the recording function cannot be performed at the same time.)

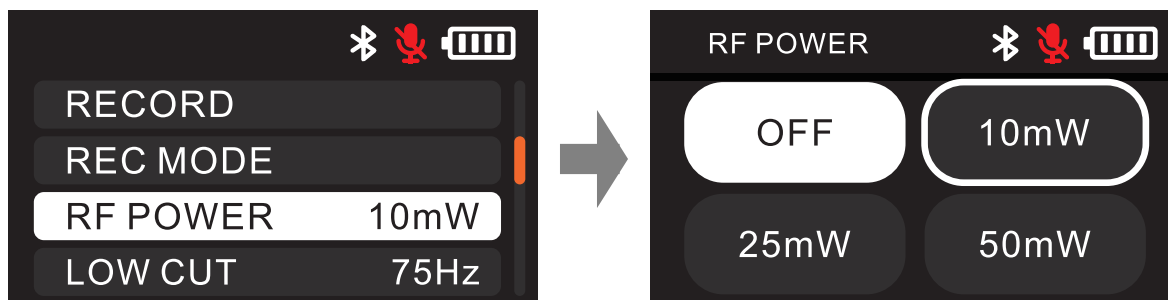

## LOW CUT

In this mode, you can set the low cut value according to your needs, and there are four low cut value options to choose from: OFF, 75Hz, 100Hz and 150Hz.

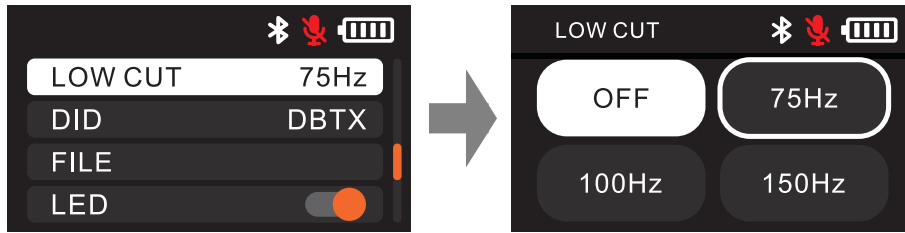

## DID

In this mode, you can change the name of the device according to your needs, select the characters to be adjusted by selecting the up and down keys, and click OK key to save the selection or click Back key to restore the previous settings.

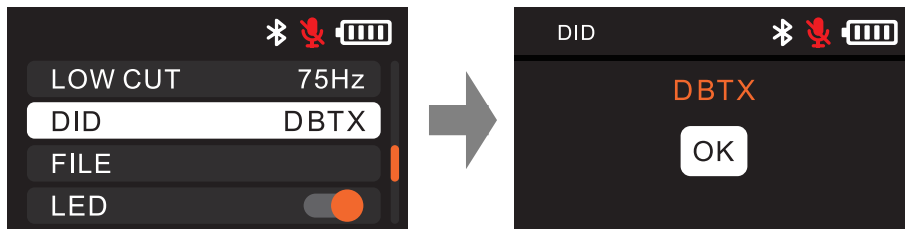

## FILE

In this mode, you can view and play back the material files in the recording memory card, and choose the corresponding file playback by pressing the up and down keys, and only files recorded on the current can be viewed.

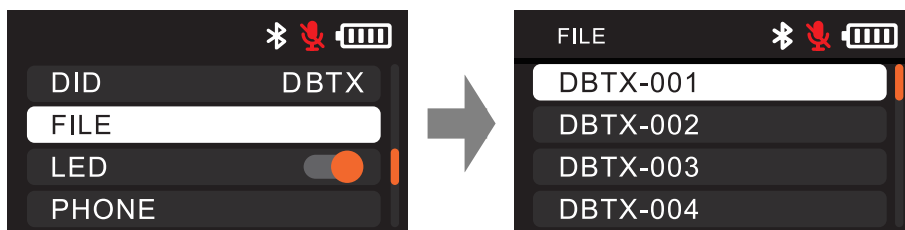

## LED

In this mode, users can choose to turn on and off the three LED indicators of the device according to their needs.

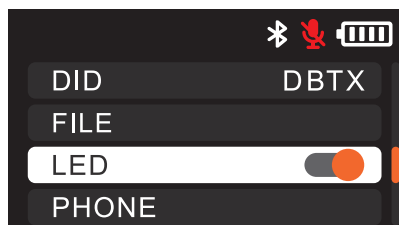



## MONITOR

In this mode, you can choose to turn on/off the monitoring function and set the output volume of the monitoring. By default, the monitoring is turned on.

The gain effects of LEVEL1-11 gears are as follows:

1	—	-9dB	7	—	-3dB
2	—	-8dB	8	—	-2dB
3	—	-7dB	9	—	-1dB
4	—	-6dB	10	—	0dB
5	—	-5dB	11	—	+3dB
6	—	-4dB			

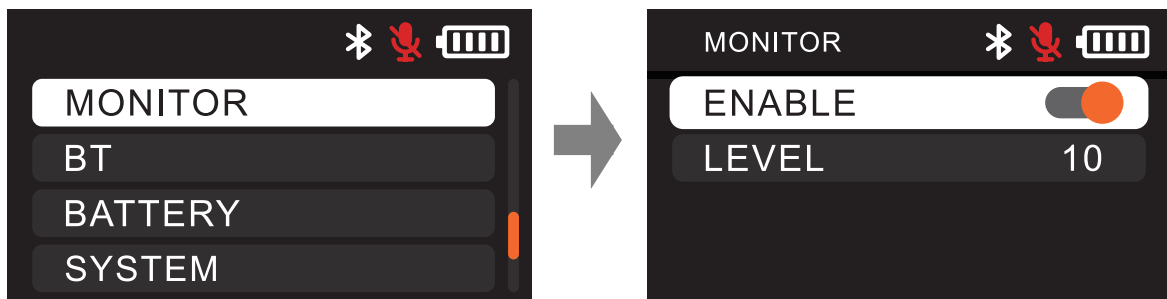

## BT

In this mode, you can turn the Bluetooth function on/off. Bluetooth is turned on by default. Select "RESET" and click "YES" to reset Bluetooth. When the "SUCCESS" message appears, it means that the reset is complete.

The MAC address is the Bluetooth physical address number of the current device, which is the unique identification code of the device from the factory, and can distinguish different devices when the mobile phone is connected with Bluetooth.

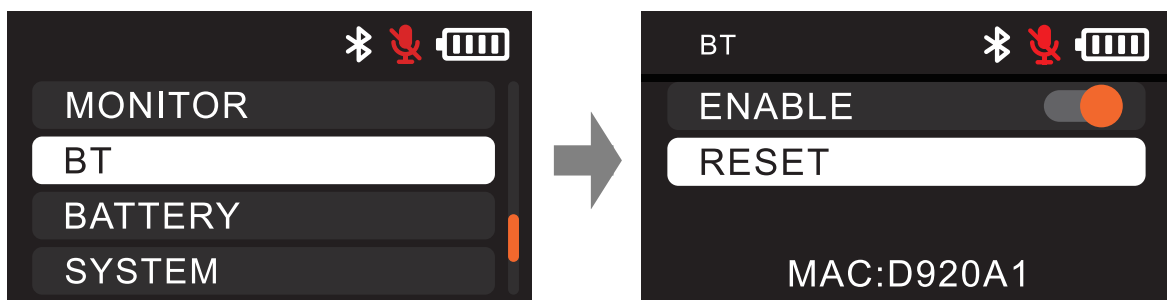

## BATTERY

In this mode, you can choose the corresponding battery type according to the actual usage, so that the machine can calculate the remaining battery life of the device more accurately. There are four battery type options in this mode: DEITY AA: DEITY lithium iron battery; Alkaline: a traditional alkaline battery; Lithium: 1.5V stabilized lithium battery; NiMH: 1.2V Ni-MH rechargeable battery.

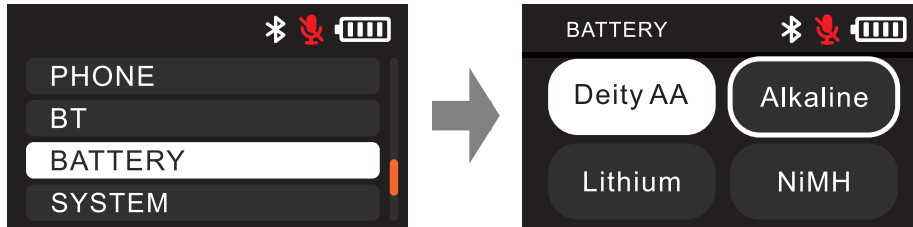

## SYSTEM

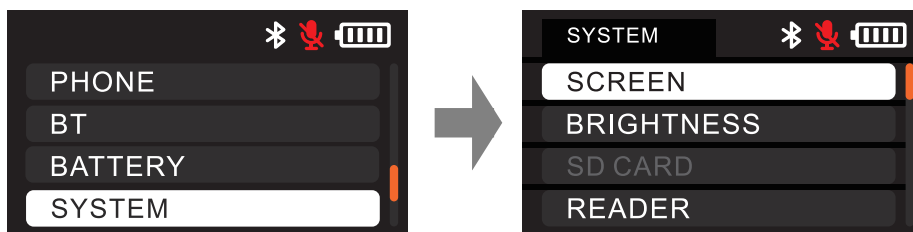

## SCREEN

In this mode, you can choose to set the time for the screen to light continuously when it is not in operation (the system defaults to 15s). There are four options: Never, 15s, 1 min and 5min. After the first use, the system will keep the previous settings.

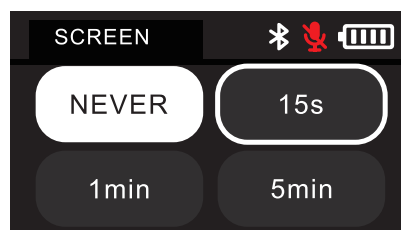

## Brightness

In this mode, you can choose to adjust the brightness of the screen, and five brightness gears can be adjusted. By default, the brightness is the brightest "5". After you adjust the settings, the system will keep the previous settings.

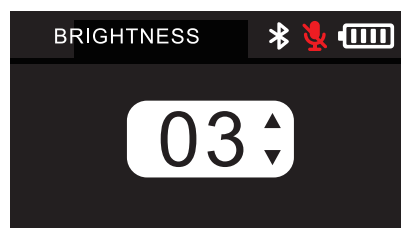

## SD CARD

In this mode, you can see the storage space occupied by the memory card. Select "FORMAT" and click "YES" to format the memory card. When the "SUCCESS" message appears, the formatting is completed. (The memory card is formatted and then used when it enters the device, which can get higher recording stability.)

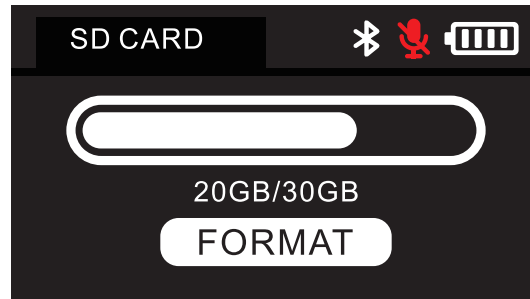

In this mode, you can see the storage space occupied by the memory card. Select "FORMAT" and click "YES" to format the memory card. When the "SUCCESS" message appears, the formatting is completed.

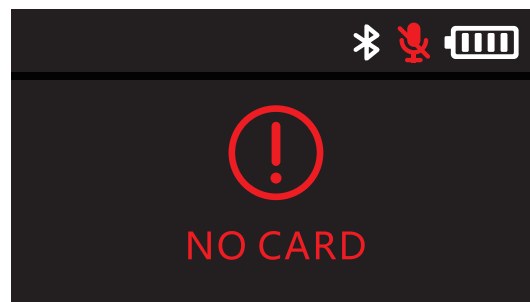

## READER

In this mode, you can connect the computer through the data cable to transfer the recorded files.

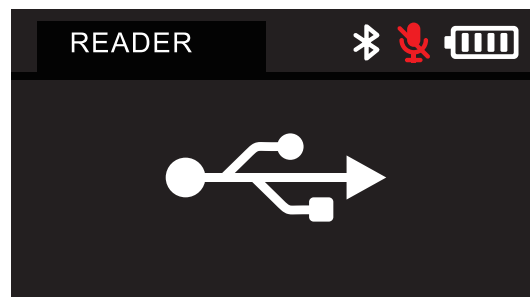

## HOTKEY

This mode can choose whether to turn on the function of shortcut keys in the main interface.

Turn on MUTE mode to turn on mute by short pressing the power key in the main interface.

When the REC/TC mode is turned on, you can enter the recording or timecode interface by long pressing the “up/down direction key” for a long time, while when it is turned off, you cannot use the shortcut key function.

Turn on the GAIN mode to quickly adjust the gain level of the microphone.

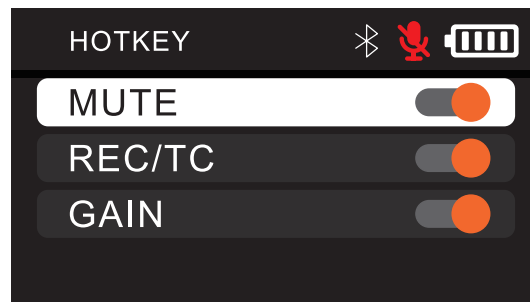

## SYS RESET

In this mode, you can choose to reset the system (system reset only resets the device system settings, not the frequency band data), click “YES” to reset the system settings, and when the “SUCCESS” message appears, the system settings are reset.

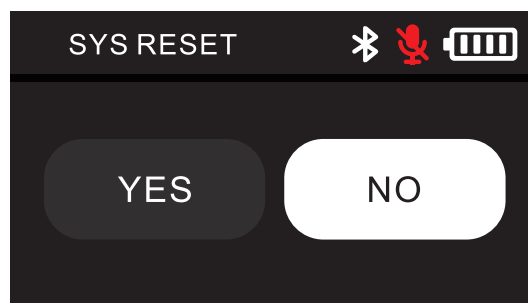

## FIRMWARE

This mode can view the version information of the current device and the date information when the version is updated.

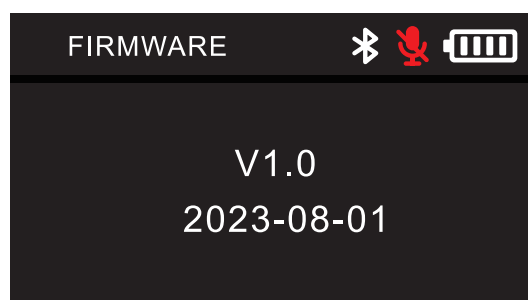

## UPGRADE

This product can be upgraded by USB STICK or SD card, and supports exFat/FAT32 partition format U-Disk. When upgrading, please load the latest firmware in official website and put it in the root directory of U-Disk or SD card. You can use “USB-C to USB-A firmware upgrade adapter” to connect U-Disk to USB Type-C input port. After the firmware update is completed, the firmware version will display the latest version number. You can enter the “FIRMWARE” option in the system settings menu to inquire the firmware version information of the current device.

If you don't insert the SD card or U-Disk into the device, or the device can't read the internal upgrade file, “NO DISK” will be prompted. Please check whether the SD card or U-Disk is correctly inserted into the device, or whether the upgrade file is complete or placed in the corresponding position as required.

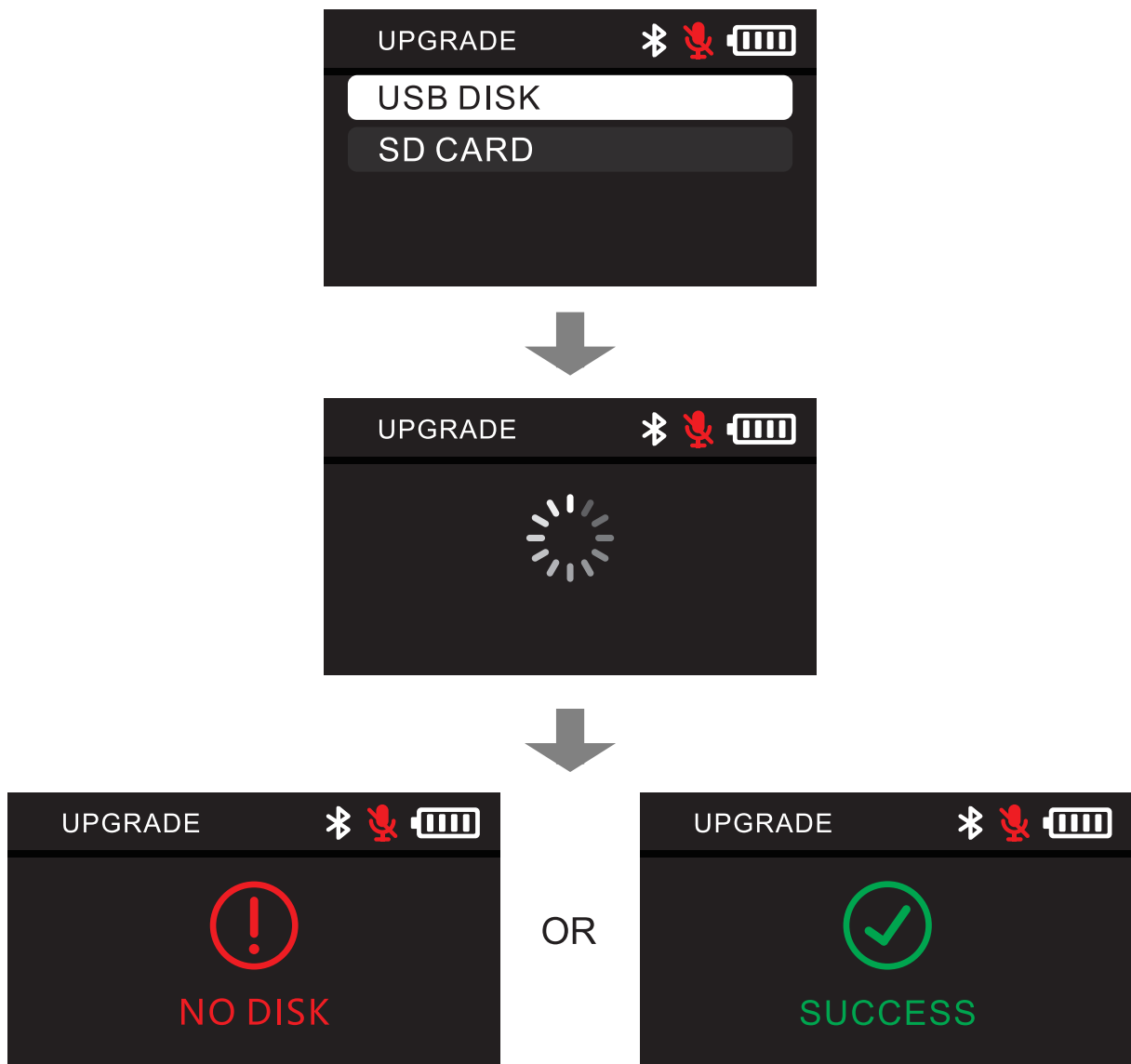

Insert the SD card into the device, select the “UPGRADE” option in the menu, and update the firmware according to the screen prompts. After the firmware update is completed, the device will automatically restart, and the firmware version will display the latest version number. You can enter the “Firmware” option in the system settings menu to inquire about the firmware version information of the current device.

If you don't insert the SD card into the device, or the device can't read the upgrade file in the SD card, “NO CARD” will be prompted. Please check whether the SD card is correctly inserted into the device, or whether the upgrade file in the SD card is complete or placed in the corresponding position as required.

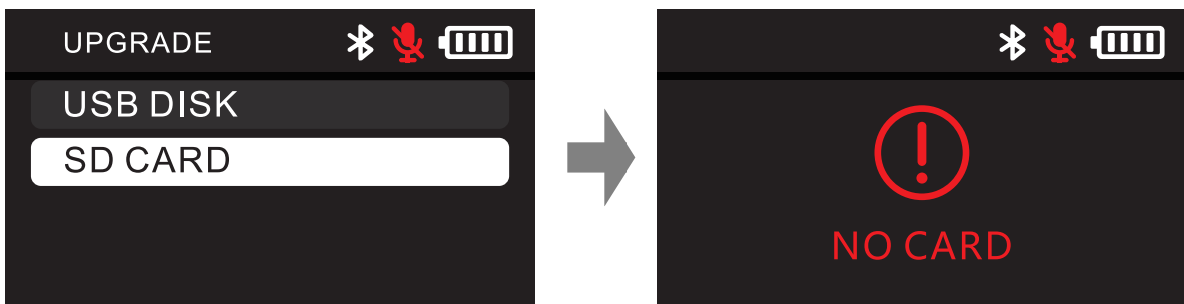

## DATE/TIME

Enter the mode to set the used date and time.



You can customize the current time information for the device. Click OK to enter the time adjustment. Press the up and down keys to adjust the time number. After the adjustment is completed, click OK to save the set time information, and click Back to return to the time information set last time or initially.

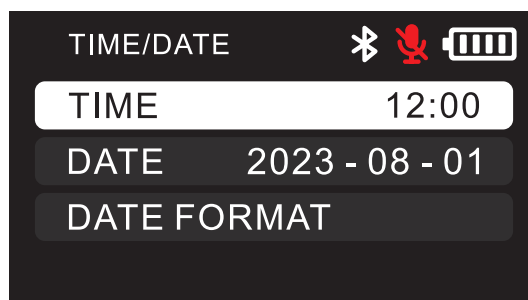

DATE setting can customize the current date information for the device. Click OK to enter the date adjustment. Press the up and down keys to adjust the date number. After the adjustment is completed, click OK to save the set date information, and click Back to return to the date information set last time or initially.

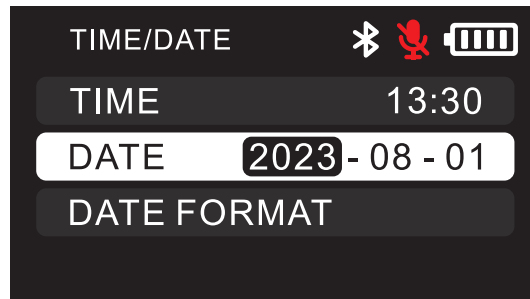

DATE FORMAT can be set, and in the "DATE/TIME" setting, you can see a variety of date formats to choose from. You can choose a common date format: "DD/MM/YY", "MM/DD/YY" or "YY/MM/DD". You can select the corresponding date/time format by pressing the up and down keys and click OK to save the selected settings. The date and time format shall not be saved by clicking Back.

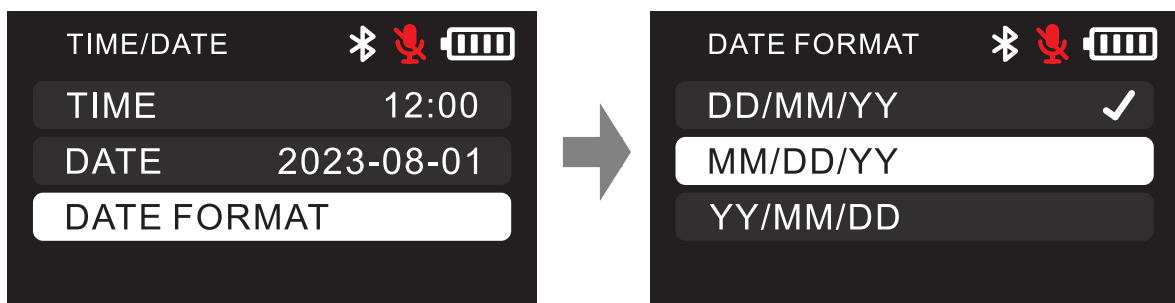

# D2RX Interface Function Operation

## D2RX main screen interface

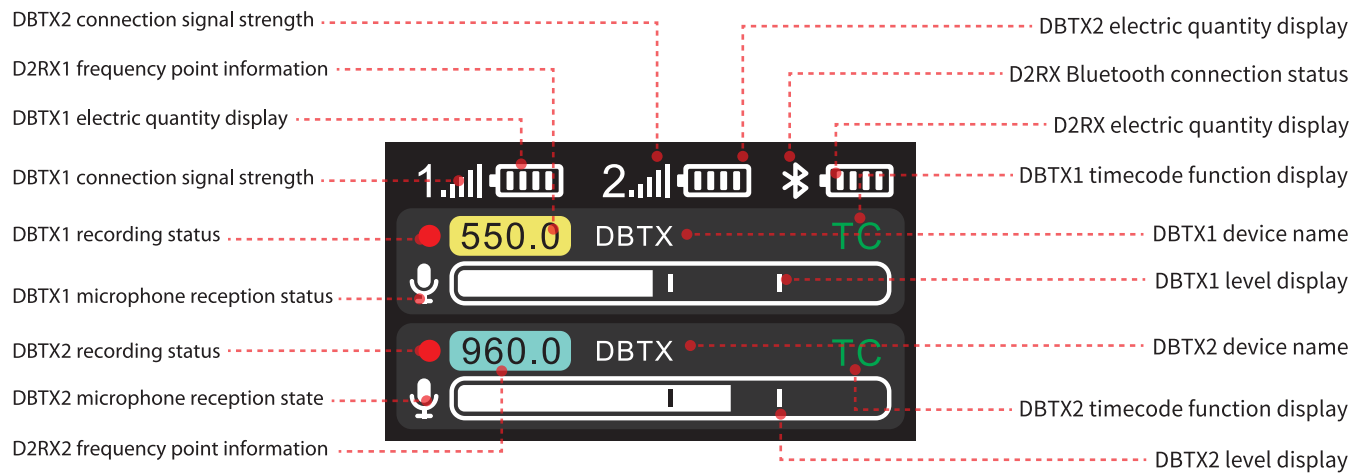

## D2RX gain shortcut key operation

Long press the “Up direction key” to enter the output gain adjustment mode of the output port A. You can adjust the output gain through the “Up/Down” direction key. There are 31 gears of gain adjustment, and the gain can be customized according to the usage scene. The adjustable output range is -20 ~ +10dB.



Long press the “Down direction key” to enter the output gain adjustment mode of the output port B. You can adjust the output gain through the “Up/Down” direction key. There are 31 gears of gain adjustment, and the gain can be customized according to the usage scene. The adjustable output range is -20 ~ +10dB.





## MONITOR

When the output mode of OUT TYPE-B is MONITOR, the monitor volume can be adjusted through the “Up/Down” direction keys. There are 12 gears of volume adjustment, and the volume can be customized according to the usage scene.

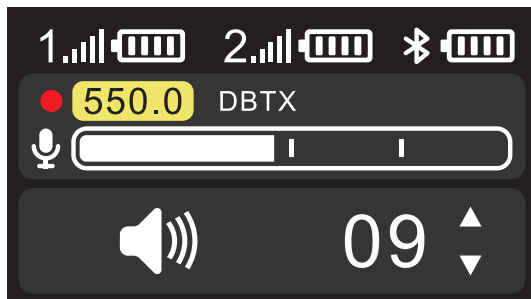

## MENU

### RF SET

In this mode, you can control the ON/OFF of two RF channels. By default, this function is all on. You can choose whether to turn off the RF function of the corresponding channel according to the usage, so as to reduce the RF power consumption when the channel is not connected, thus reducing unnecessary power waste and prolonging the service time of the device.

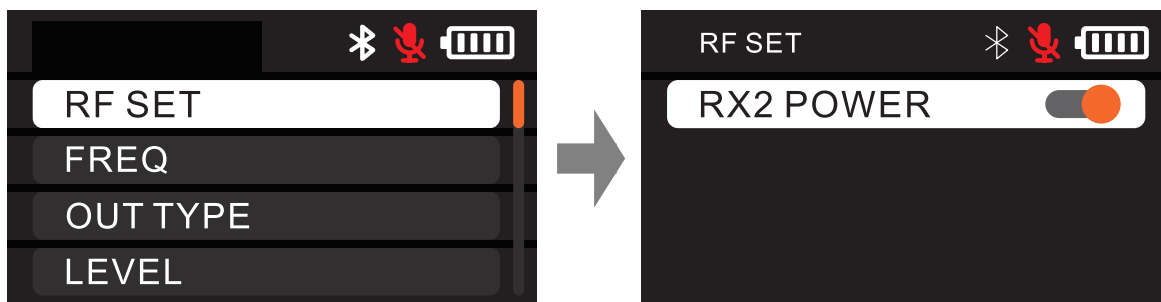

### FREQ

Entering this mode, you will be able to set the frequency-related functions of the device.

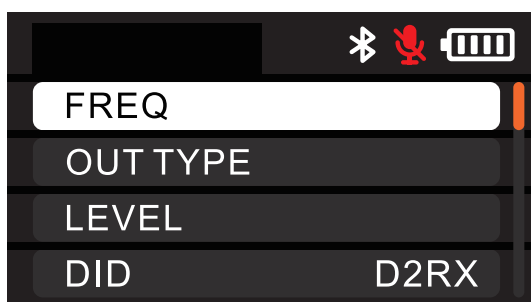

## SCAN

Entering this mode, you can scan the information of wireless frequency points in the current environment and select clean frequency points with little interference to use.

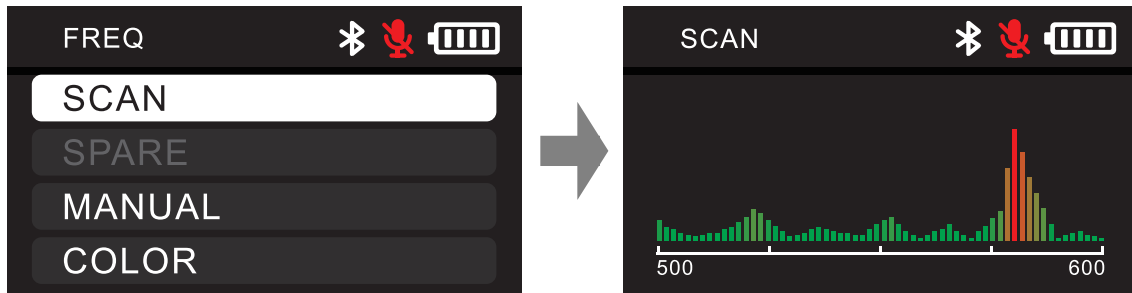

If you don't use the automatically allocated frequency point information, you can click the back key, and manually select the frequency point by "Up and Down keys" to send synchronization to TX for use according to the result of frequency scanning

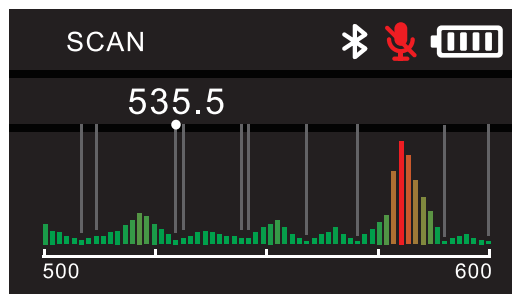

The optimal frequency point can be automatically distributed after the frequency scanning



Click "YES" to send the synchronously scanned frequency points to the transmitter, and click "NO" to cancel the synchronous frequency point distribution.

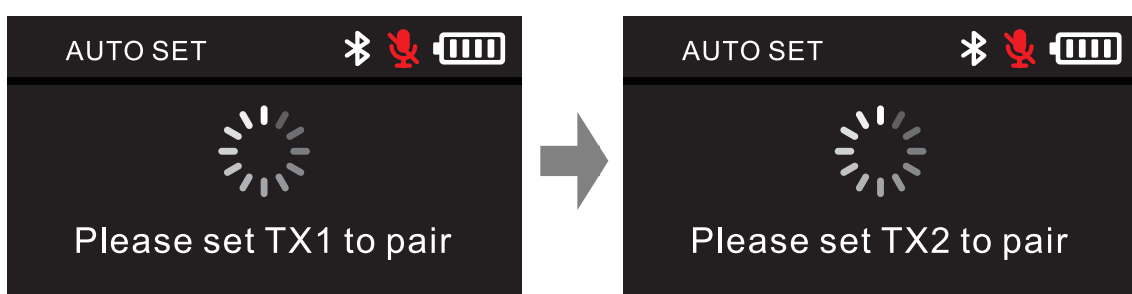

## SPARE

TUNE mode is to list 10 clean and preferred frequency points according to the signal frequency points after frequency scanning. You can select the frequency points to be synchronized in the list, and click on the corresponding frequency point to send the frequency points to TX synchronously.

If the frequency scanning is not carried out after the machine is turned on, the TUNE function is not selectable.

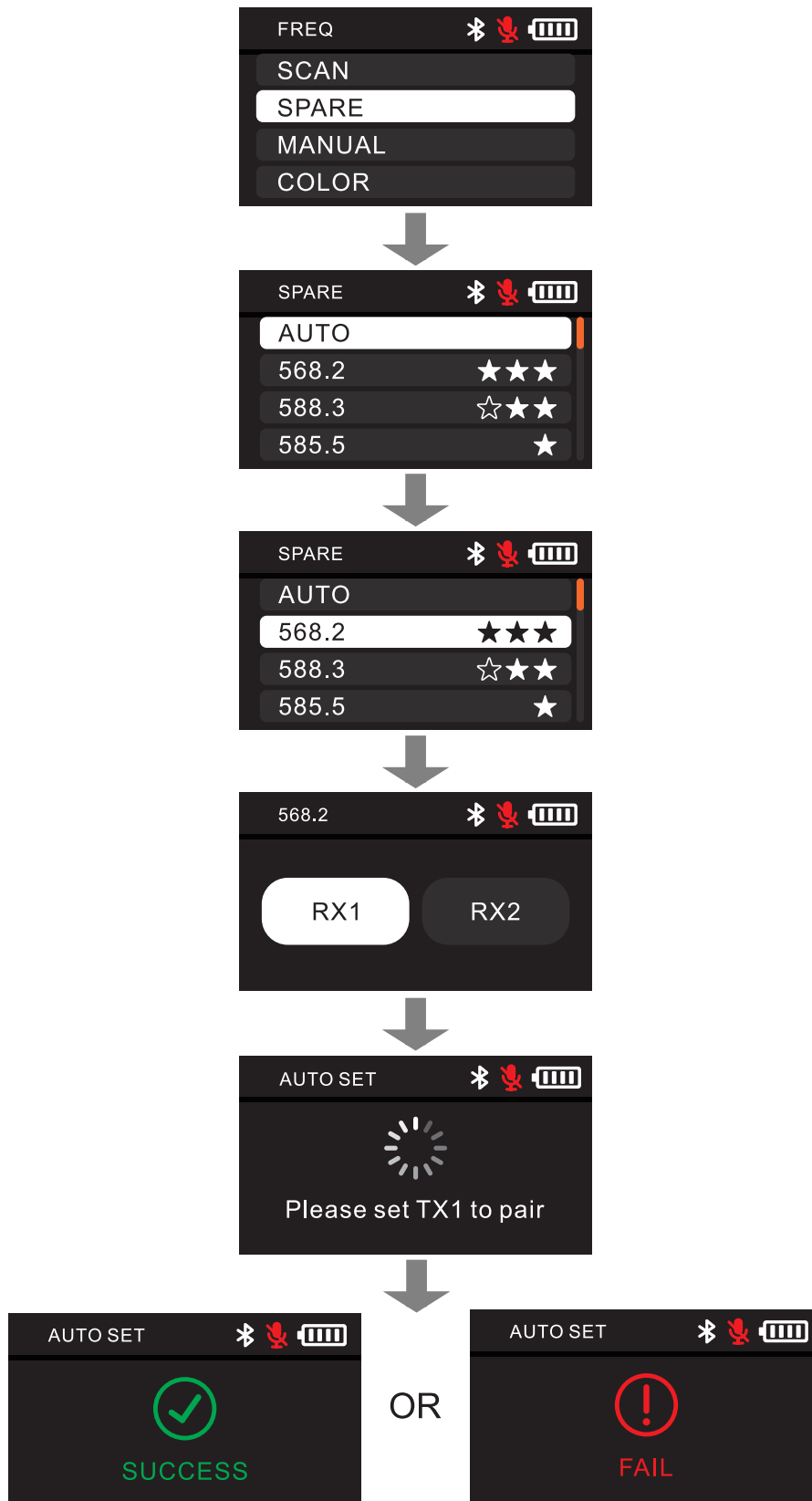

## MANUAL

In this mode, you can manually adjust the frequency point information of the corresponding channel of RX to match the same frequency point information with the corresponding TX transmitter.

Wireless pairing requires TX to enter the corresponding pairing interface at the same time. Selecting PAIR1 will distribute the wireless synchronous transmitter to channel A and selecting PAIR2 will distribute the wireless synchronous transmitter to channel B.

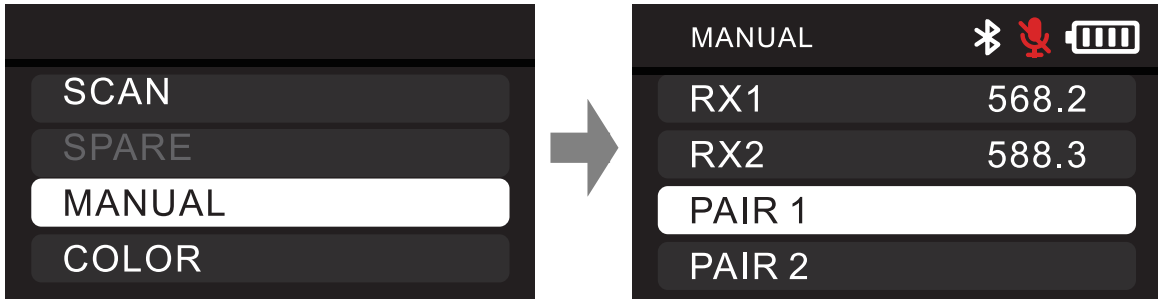

## COLOR

In this mode, you can select a color mark and synchronize the corresponding color mark to the paired TX to distinguish the connected devices in the same frequency band.

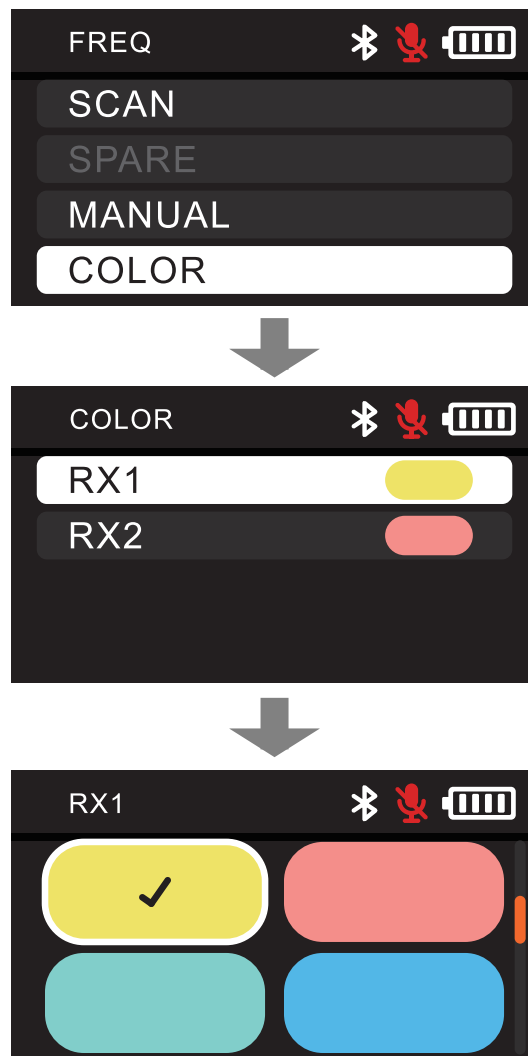

## OUT TYPE

Enter OUTTYPE to adjust the sound mode output by the current channel. Channel A can output the sound of the corresponding channel independently, or it can set the sound output of dual channels- When outputting sound, channel A is the left channel and channel B is the right channel. Channel B can be set to output the sound of the corresponding channel independently and set the sound output of two channels-When outputting sound, channel A is the left channel and channel B is the right channel.Channel B can be set to monitor output mode.The output audio is the same as that of channel A.

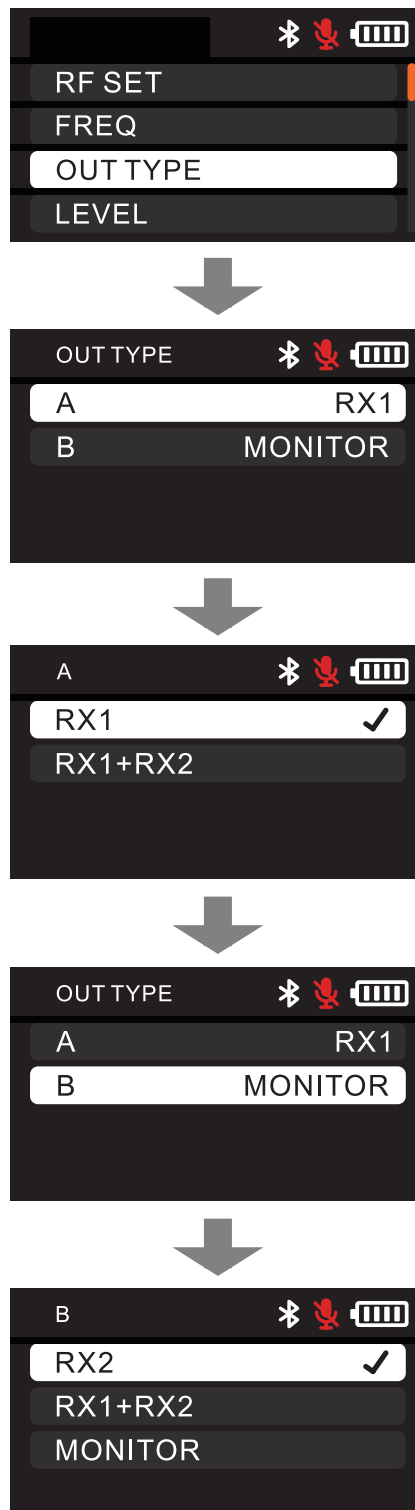

## LEVEL

Entering this mode, you will be able to select the gain parameters of the audio output of the corresponding channel, with a total of 10 gears to choose from. The MONITOR function can only set the gain parameters when the MONITOR monitoring output mode is selected in the OUT TYPE channel B, and the rest of the time, it will be displayed in gray, indicating that the parameters cannot be adjusted.

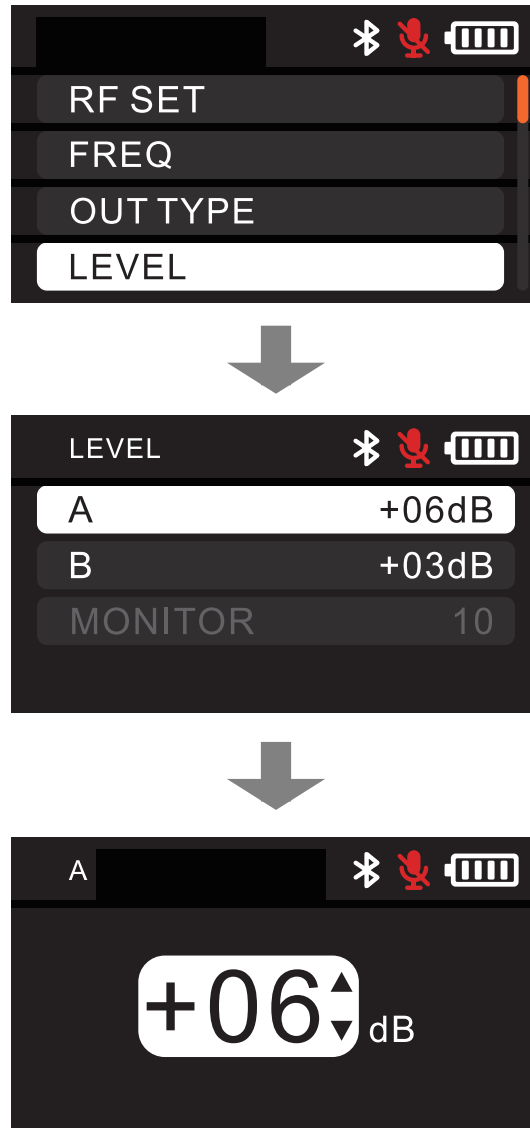

## DID

In this mode, you can change the name of the device according to your needs, and select the characters to be adjusted by selecting the Up and Down keys.



## BT

In this mode, you can turn the Bluetooth function on/off. Bluetooth is turned on by default. Select "RESET" and click "YES" to reset Bluetooth. When the "SUCCESS" message appears, it means that the reset is complete.

The MAC address is the Bluetooth physical address number of the current device, which is the unique identification code of the device from the factory, and can distinguish different devices when the mobile phone is connected with bluetooth.

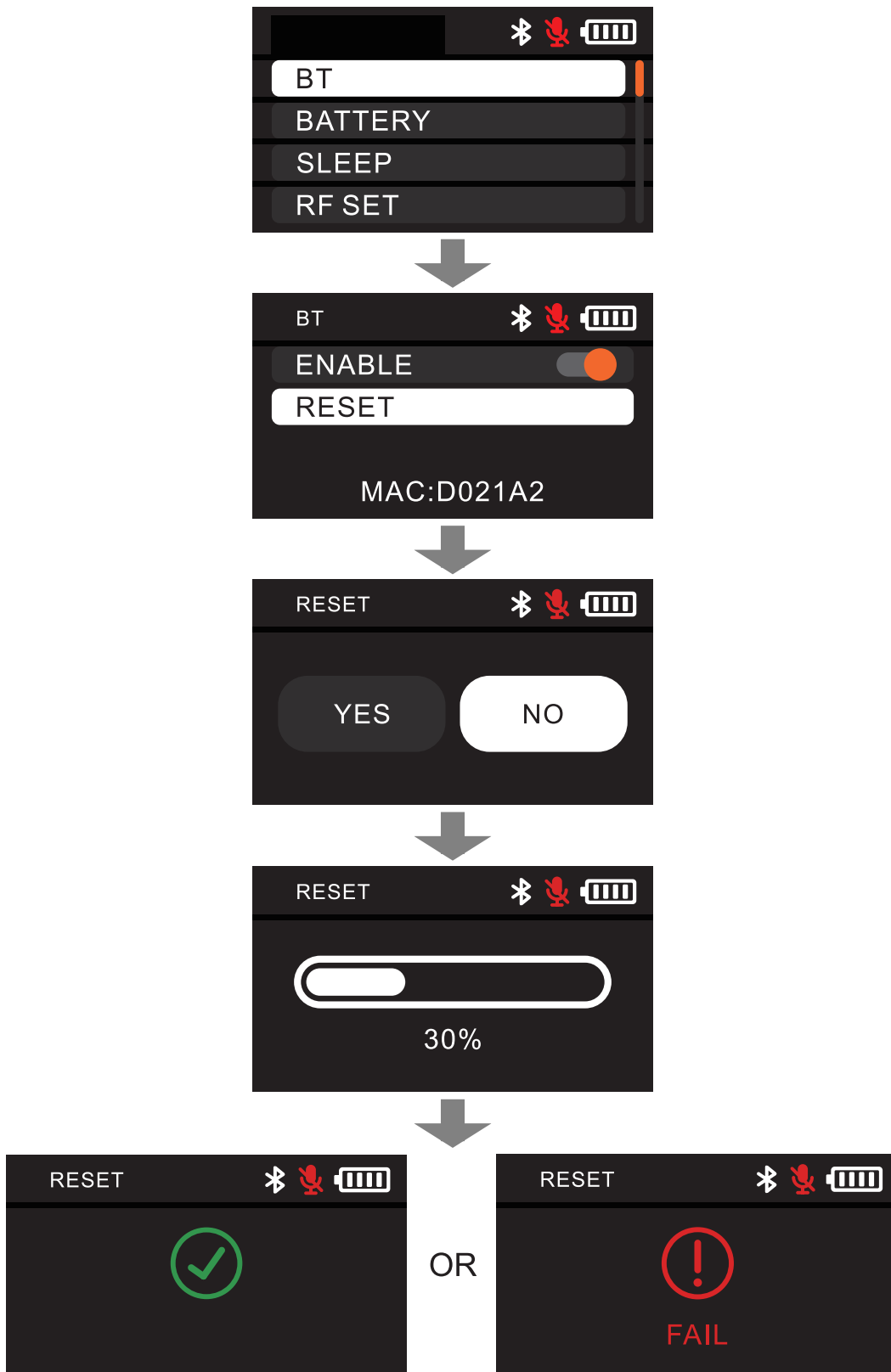



## BATTERY

In this mode, you can choose the corresponding battery type according to the actual usage, so that the machine can calculate the remaining battery life of the equipment more accurately. There are four battery type options in this mode: DEITYAA: DEITY lithium iron battery; Alkaline: a popular traditional alkaline battery; Lithium: 1.5V stabilized lithium battery; NiMH: 1.2V Ni-MH rechargeable battery.

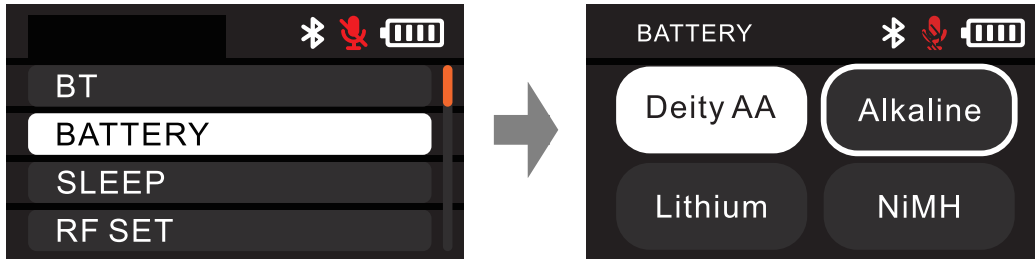

## SLEEP

In this mode, you can set the sleep function of the connected DBTX transmitter. In sleep mode, DBTX only keeps Bluetooth connection, 2.4G connection and timecode function. You can choose whether to turn on the sleep function of controlling RX1 or RX2 through the switch. Exit this mode and wake up the matched DBTX immediately.

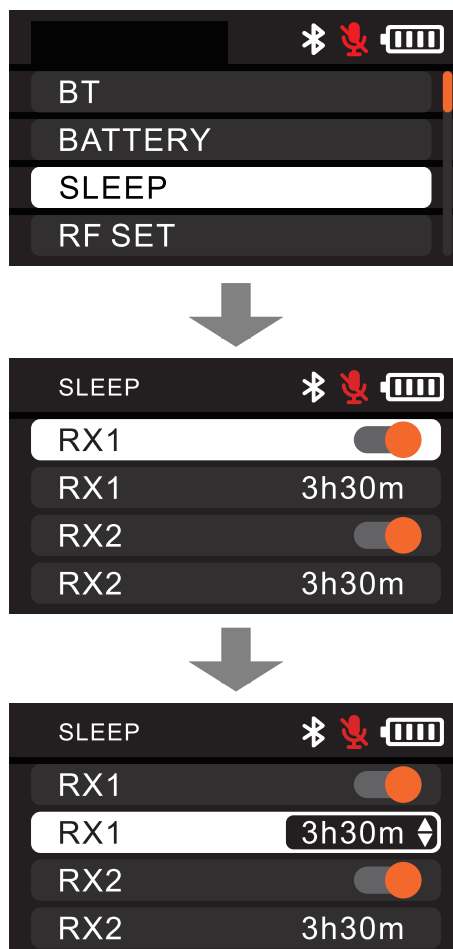

## SYSTEM

### SCREEN

In this mode, you can choose to set the time for the screen to light continuously when it is not in operation (the system defaults to 15s). There are four options: NEVER, 15s, 1min and 5min. After the first use, the system will keep the previous settings.

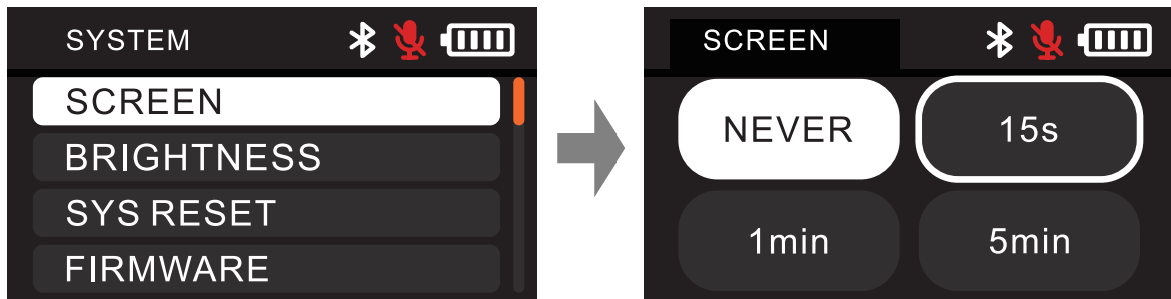

### BRIGHTNESS

In this mode, you can choose to adjust the brightness of the screen, and five brightness gears can be adjusted. By default, the brightness is the brightest "5". After you adjust the settings, the system will keep the previous settings.

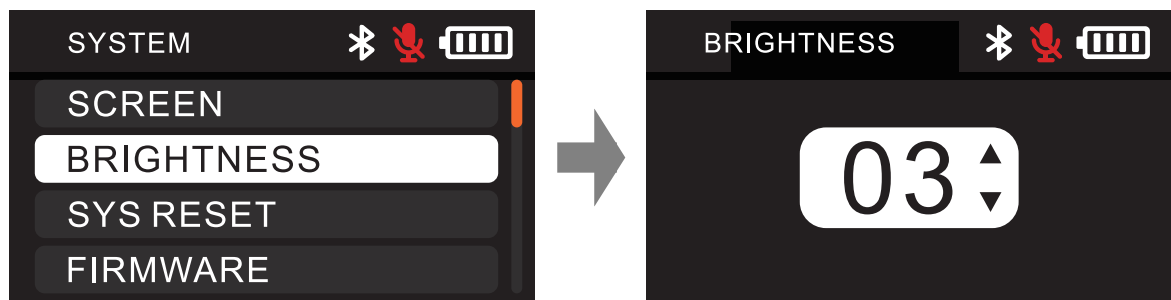

### SYS RESET

In this mode, you can see the storage space occupied by the memory card. Select "FORMAT" and click "YES" to format the memory card. When the "SUCCESS" message appears, the formatting is completed.

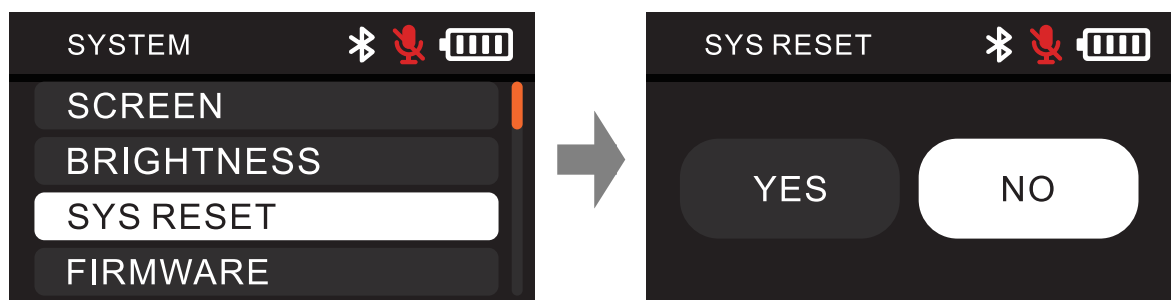

## FIRMWARE

View the current version information of the device

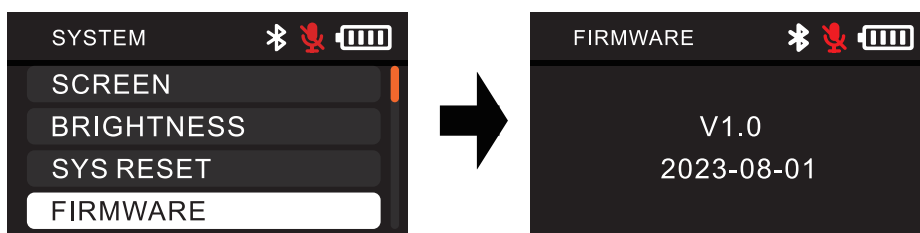

## UPGRADE

This product can be upgraded by U-Disk or SD card, and supports exFat/FAT32 partition format U-Disk. When upgrading, please load the latest firmware in official website and put it in the root directory of U-Disk or SD card. You can use “USB-C to USB-A firmware upgrade adapter” to connect U-Disk to USB Type-C input port. After the firmware update is completed, the firmware version will display the latest version number. You can enter the “FIRMWARE” option in the system settings menu to inquire the firmware version information of the current device.

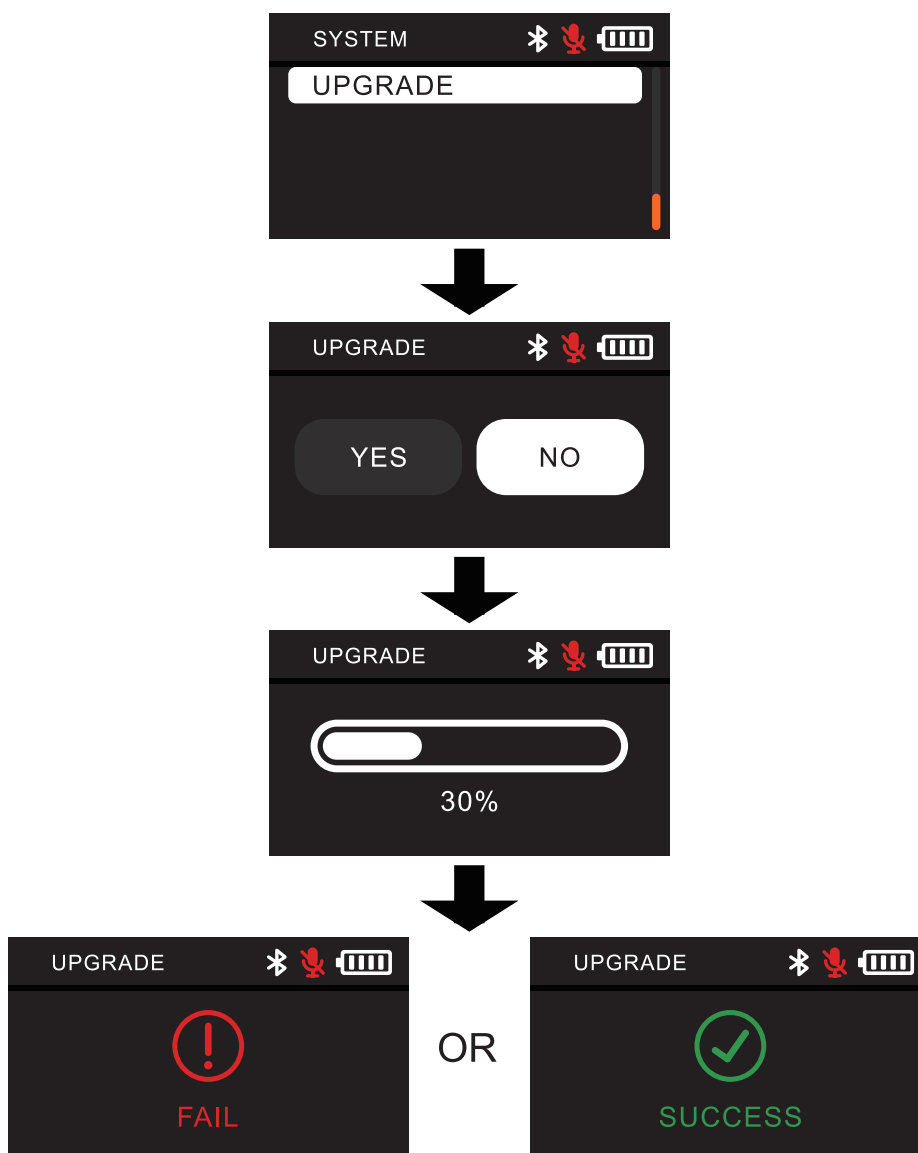

If you don't insert the U-Disk into the device, or the device can't read the upgrade file in U-Disk, "NO DISK" will be prompted. Please check whether the U-Disk is correctly inserted into the USB Type-C interface of the device, or whether the upgrade file in U-Disk is complete or placed in the corresponding position as required.

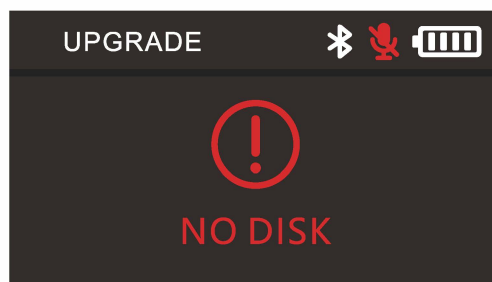
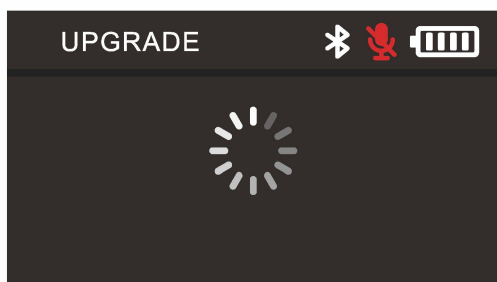

## DBTX specifications and parameters

DBTX Transmit	
RF Modulation	Proprietary Digital RF Modulation
RF Freq Ranges	According to different regions, the legitimate frequency bands in line with local conditions are allocated
RF Frequency Step	100kHz
RF Bandwidth	175 kHz
Minimum Frequency Interval	700kHz
Antenna Connector	50 $\Omega$ SMA
Power Output	9.80 d Bm
Transmitter Audio	
Dynamic Range	123dB
Distortion	<0.5%
Frequency Response	20~20kHz

Continued (DBTX specifications and parameters):

<b>Transmitter Audio</b>	
Low Cut	OFF/75Hz/100Hz/150Hz
Mic Power	MIC、LINE
Mic Connector	3.5mm TRS
Input Gain	0~+30dBu
ADC Bit-Depth	2 x 24 bit
ADC Sampling-Rate	48kHz
<b>Timecode Reader / Generator</b>	
Clock Accuracy	0.25 PPM (1 Frame Out in 48 Hours)
Timecode Type	LTC(SMPTE)
Timecode Frame-Rates	23.98, 24, 25, 29.97, 29.97DF, 30, 30DF
<b>Internal Recording</b>	
Media	MicroSD Card (Flash Memory)
File Format	.wav
Sample Rate	48kHz
Record Format	24/32bit float
<b>Power</b>	
Battery Life	Up to 12+ Hours with 2 Deity AA

Continued (DBTX specifications and parameters):

Physical	
Dimensions (H x W x D)	88.45x 65x 17.8 mm
Weight	Without battery and antenna: 88g Without battery and with antenna: 93g With battery and antenna: 125g
Operating Temperature	20°C - 45°C(-4°F-113°F)
Storage And Transportation Temperature	-30°C ~ +60°C (86°F ~ +140F)

## D2RX specifications and parameters

Transmitter Audio	
RF Modulation	Proprietary Digital RF Modulation
RF Freq Ranges	According to different regions, the legitimate frequency bands in line with local conditions are allocated
RF Frequency Step	100kHz
RF Bandwidth	200kHz
Minimum Frequency Interval	700kHz
Antenna Connector	2 x 50 Ω SMA
Sensitivity	-95dBm
Receiver Audio: Analog Output (x2)	
Dynamic Range	103dB
Distortion	<0.5%
DAC Bit-Depth	24bit

Continued (D2RX specifications and parameters):

<b>Receiver Audio – Digital Output (x1)</b>	
Audio Output Connector	USB-C
<b>Power</b>	
Battery Life	Up to 8+ Hours with 2 Deity AA
<b>Physical</b>	
Dimensions (H x W x D)	89.47 x 66.81x 20.06 mm
Weight	Without battery and antenna: 104g Without battery and with antenna: 117g With battery and antenna: 147g
Operating Temperature	20°C - 45°C(-4°F-113°F)
Storage And Transportation Temperature	-30°C ~ +60°C (86°F ~ +140F)

The above data are all measured by Aputure Audio Lab, which is subject to the physical data!

Note: The illustrations in this manual are only for reference. Due to the continuous development of the new version of the product, if there is any difference between this product and the user manual, please refer to the product itself.

## DISCLAIMER

Before using this product, please read the user manual to ensure correct use under the complete understanding. After reading, keep the product manual properly for future reference. In case of not operating this product correctly, it may seriously harm yourself or others, or result in product damage and property loss. When using this product, it shall be deemed that you have understood, recognized, and accepted all clauses and contents of this document. The user commits to be responsible for their own behaviors and all consequences thereof. Aputure shall not be liable for any loss due to the user not using this product in accordance with the product manual.

Under the laws and regulations, our company holds the final explanation right of this document and all related documents of this product. No prior notice will be given for any updates, revision, or termination. Please visit the official Aputure website for the latest product information.