

ULTRATAB™ by Jazz 7" Tablet



Jelly Bean
Operating System



C714
Instruction Manual

Attention:

This handbook contains important security measures and product information essential for using the device safely. Please read this manual carefully before using the device.

- Do not place the device in high temperatures, moist areas or very dusty places.
- During seasons with hot temperatures do not leave the device in a car with the windows closed.
- This tablet is a sophisticated device. Please handle with care and do not drop as it may damage the display screen.
- Please choose the appropriate volume. When utilizing headphones please ensure the volume is not set at high level.

- Charge the device under the following conditions,
 - A、 The battery power ICONS show there is no power
 - B、 The system automatically shuts off
 - C、 The Operation buttons does not respond

- Do not disconnect the device when it is formatting, downloading or uploading a file as it can cause an application error.
- Follow the user manual for standardized operational use of the device.
- Don't disassemble the product. Do not use alcohol, thinner or benzene to scrub the product.
- Don't use the device in a place that prohibits use of electronic equipment.
- Please don't use the Tablet PC when you are driving or walking down the street.
- USB is only to be used for data transmission.

The company reserves the right to improve the product, product specifications and design and/or make any other changes. The information is subject to change without prior notice.

(This tablet does not have a waterproof function)

【Remark】 All pictures in this manual are only for your reference. The products specification and design may change. The information is subject to change without prior notice.

1. Appearance and button:

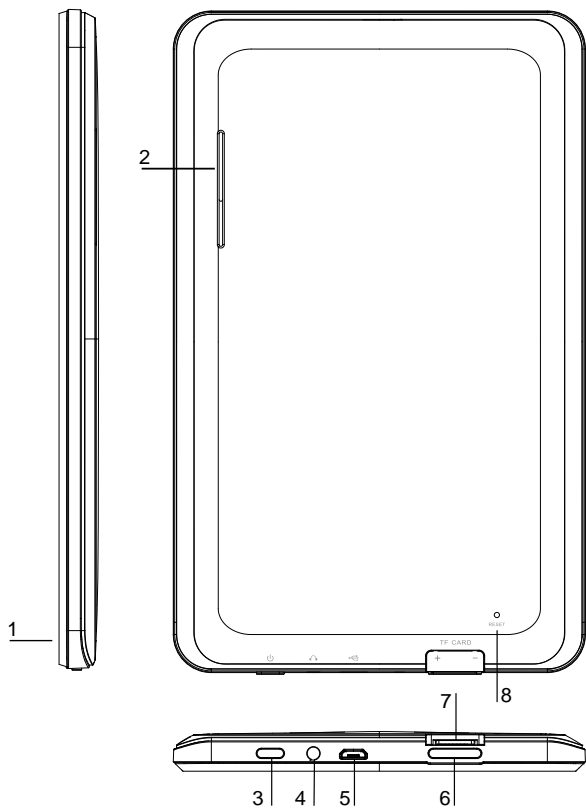

Number #	Description
1	Front Camera (0.3MP)
2	Speaker
3	<p>Power button</p> <p>Startup: Hold down the power button for several seconds. The tablet will turn on and then the system will enter the main interface.</p> <p>Shutdown: In the main menu interface, press the power button for several seconds to shutdown, The system will hint the "power off" option. Click "OK". Now you can safely shut down.</p> <p>Turn off screen: When the screen is on, short press Power button to turn off screen. Short press Power button again to turn on screen.</p> <p>Remark 1. When the power is depleted the system will shut down automatically.</p> <p>2. Restart will scan and restore the disk. It may take a longer time to enter into system.</p>
4	Headphone jack: 3.5mm standard headphone jack
5	Micro USB interface: Connect the tablet and computer, realizes the data transmission. Also can use charging for tablet.
6	Volume button (Volume + / Volume -): Use Volume + and Volume - to adjust the volume.
7	TF-card slot: External T-FLASH card, support up to 32GB
8	Reset button : If the device is freezing or stuck, pls press the reset button (the small hole)

2. First use

2.1 Battery management and charge

Prior to first use, make sure the battery is fully charged

To charge simply connect the adaptor (to AC wall outlet) or USB cable (to USB port on your computer).

Charge for six hours for the first two times .Following that the battery need only be charged for 4 hours.

【Remark】 : This tablet has a Built-in type Lithium ion battery, To charge, use a standard adaptor . Also USB interface can charge by inserting one end of USB cable to USB interface of tablet and the other end to an available USB port on your computer.

While charging, the battery icon will scroll. When charging is complete the battery icon will become green and stop scrolling.

In order to prolong the service life of the device, let the battery deplete before charging.

【Remark】 : 1. Charge the battery at least once a month to avoid power consumption caused damage.

2. After low battery shut down, connect the DC adaptor. While charging, you will need to wait some time until the battery has enough power to switch on and enter into main menu.

3. Device charging should be in standby status to reach normal charging time; charging time may take longer if using the tablet during charging.

2.2 Connection with PC

Use USB cable to connect the device to a PC. After several seconds, click the lower right corner of the screen. A menu comes out on the lower right corner. Click the option 'USB connected'. The device will pop up the USB connection window. Click 'Turn on USB storage' to connect to PC.

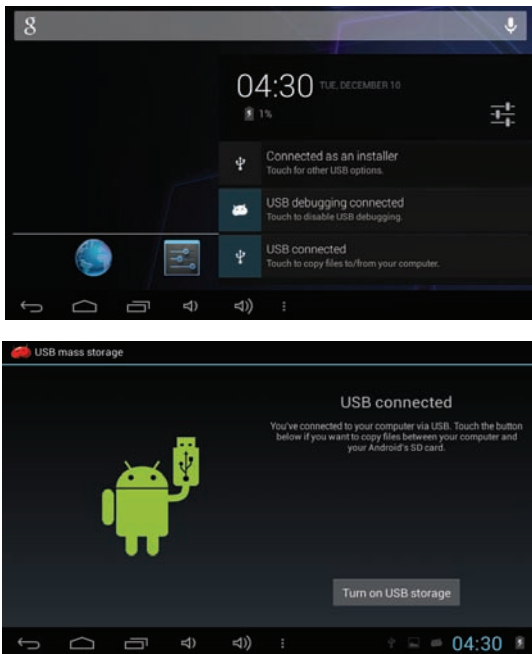

In storage mode, it can copy; delete the file on the device and the file on the memory card.

3. Equipment operation interface

3.1 Unlock Interface

After start up, the Locking interface will be as follows:

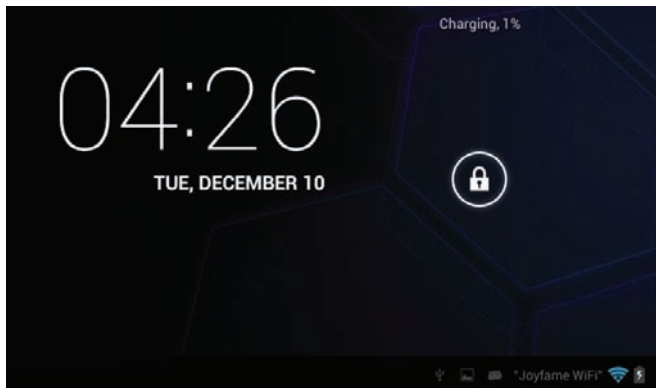

Tablet can operate only after unlocking.

Unlocking method: touch the right lock icon, drag it next to a lock at the right or bottom and release. The system will be unlocked and will enter the main interface.

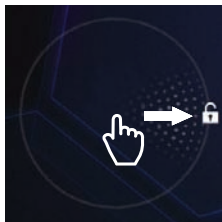
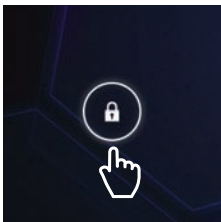

3.2 Main interface description

The main interface of the handheld tablet includes two modes: the small tools on the desktop mode and the icons of application programs mode, both of which can be switched between each other via the buttons at the corners.

The mode of small tools on the desktop is shown as follows:

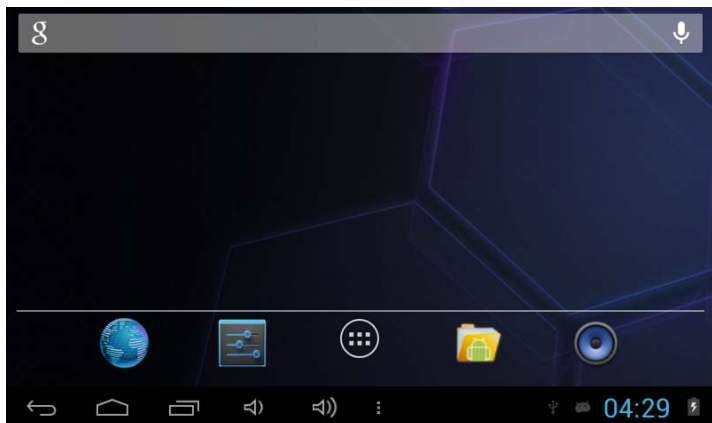

Tap  button located in the center of the main screen to enter the interface of icon modes for application programs, which is shown as follows:

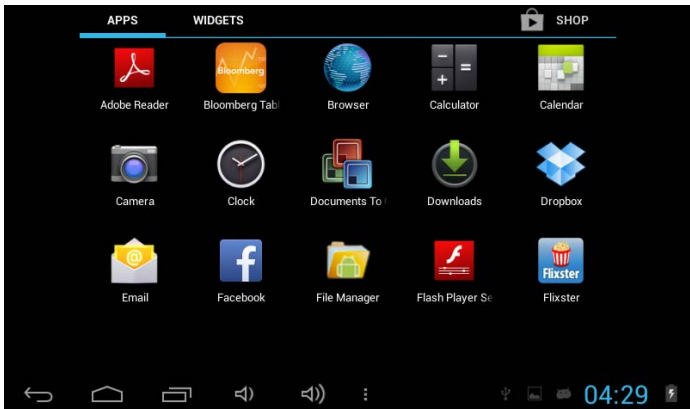

Tap  button to enter the desktop interface.

Note: If the tablet is switched on for the first time after being purchased, it will automatically install the built-in application programs. The tablet may operate slowly and some hints may appear on the screen. After installation of programs has been completed, the operation of tablet resumes normal.

3.3 Shortcut Mode

Under the interface of the mode of small tools on the desktop, after tapping lower right corner, the Shortcut menu will pop up at the bottom right of the screen, shown as follows:

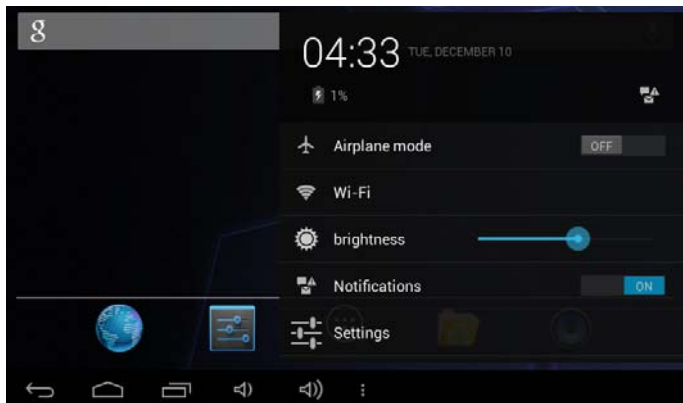

3.4 Usage of Small Tools on Desktop

Users can add or delete the small tools on the desktop, as well as add or delete icons of application programs or adjust the positions of icons; the icons can be dragged within the working zone of the desktop.

Under the interface of the mode of small tools on the desktop, press and hold the icons of small tools, a sign of 'Remove' will pop up in the central top edge of the desktop. At that time, you are able to drag the icon anywhere on the desktop, or drag it directly to the 'Remove' sign to delete it.

4. Browse Webpage

Users can connect to the Internet via the browser:

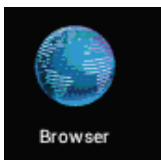

Tap the browser icon to open the network browser, and then the interface below will pop up:

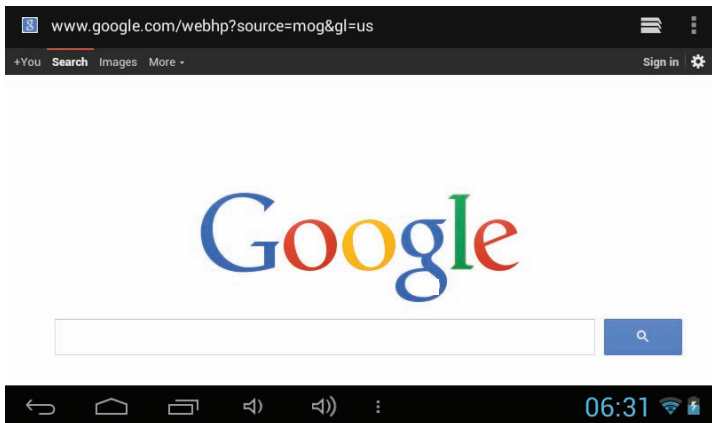

5. Introduction to Typical Application

5.1 E-mails

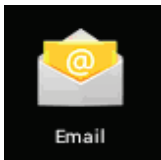

Tap the E-mail icon to enter E-mails. Do the following:

1. Set E-mail accounts
2. Set up new E-mails.
3. Receive/send E-mails
4. Download or open attachments

5.2 Browse Files

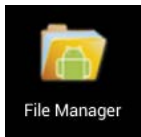

Tap the Explorer icon

to enter the interface of Browse files.

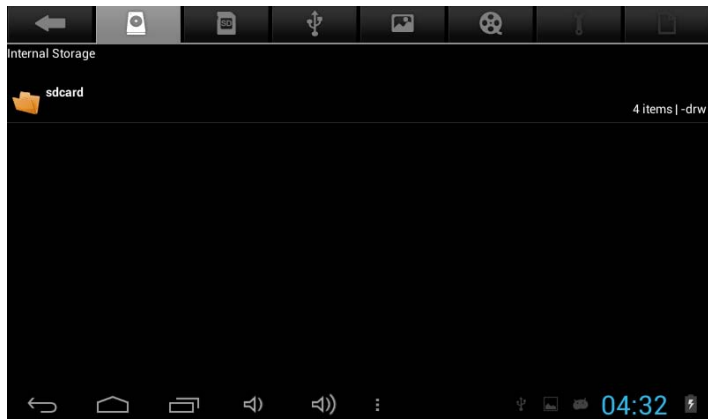

After entering the interface of Browse files, it is able to copy, move, paste or delete files in the LOCAL, SD1 or U disk.

Install Files

To install files in the file browser, tap the installation file with extension name as APK, an installation window will pop up. Select "Install" to install the software on the tablet.

5.3 Music

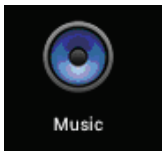

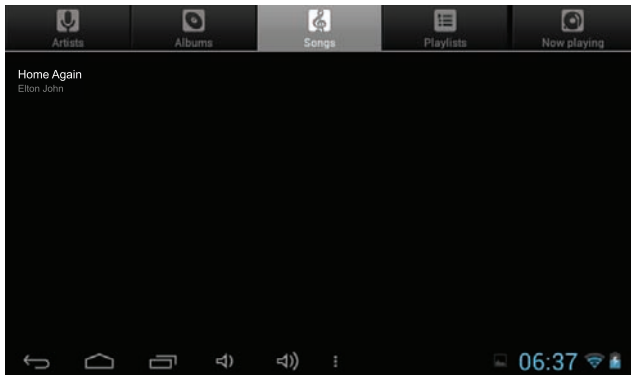

Tap the icon to enter the interface of Music.

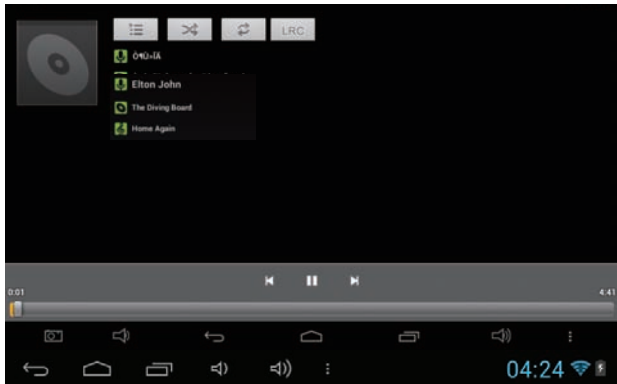

Menu options of Artists, Albums, Songs, Playlists and Now playing are displayed at the top of the interface. In addition, user can tap the menu button to pop up the following shortcut menus, including Party shuffle, Play all and Shuffle all.

Tap Music file to enter the playing interface



1. Tap  icon to enter the mode of random playing.

2. Tap  icon to switch between the mode of loop for all song, loop for current song and the mode of single song playing.

5.4 Calendar

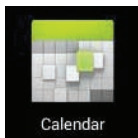

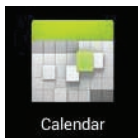
Tap  icon to check date and time, as well as add memorandums. If calendar is used for the first time, please set the calendar before using. Do the following:

1. Firstly, connect the network. Then, open the Calendar and add your name, E-mail address, and password into the pop-up dialog box. Then tap Next step.
2. During setting of the e-mail account, input information according to the tips.
3. After completion of setting, the system will exit from this interface automatically. It will then enter Calendar interface to set date, time and memos. (Note: The pre-set E-mail account can be deleted. User can also add new E-mail accounts.)

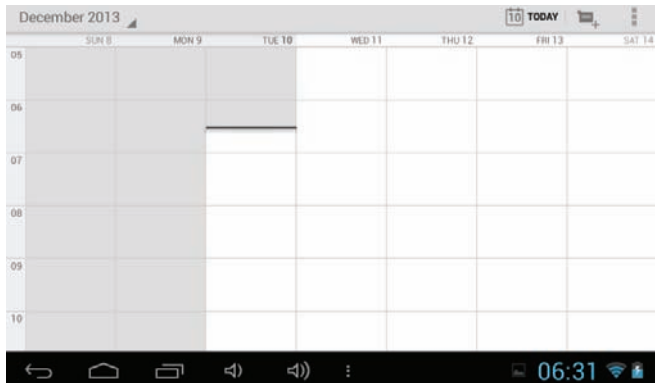

4. Options of Day, Week, Month, Agenda, Today, New event and menu button are displayed on the top of Calendar interface.

5.5 Calculator

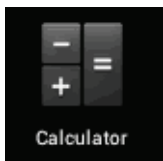

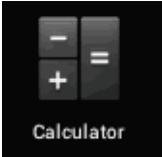
Tap  icon to conduct calculation, shown as follows:

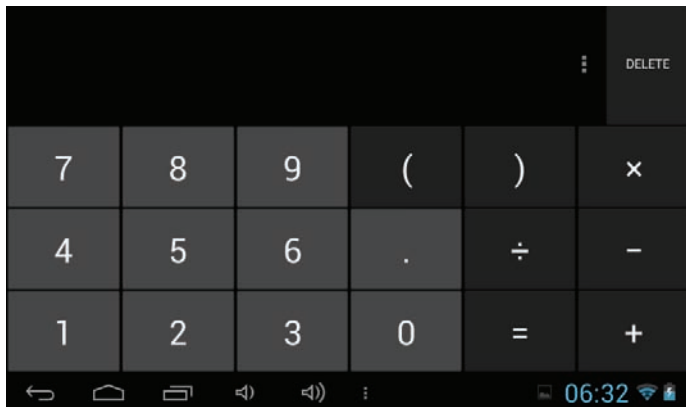

5.6 Sound Recorder

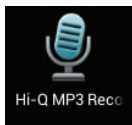

Tap

icon to enter the interface of Sound record.

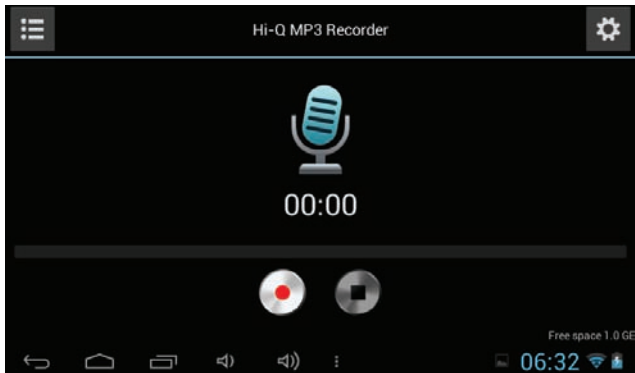

1. Tap



icon to start recording.

2. During recording, tap



to pause and



icon to stop.

3. Tap



icon to view and play the records.

5.7 Clock



Tap icon to enter the interface Tablet clock, providing functions of alarm clock, shown as follows:

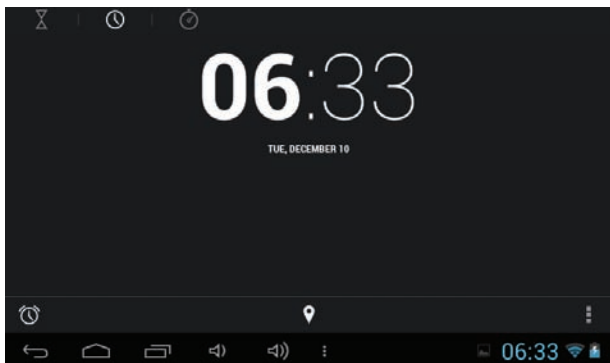

5.8 Search

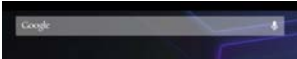
Tap  icon to enter the interface of Google search to conduct search by text, as shown below:

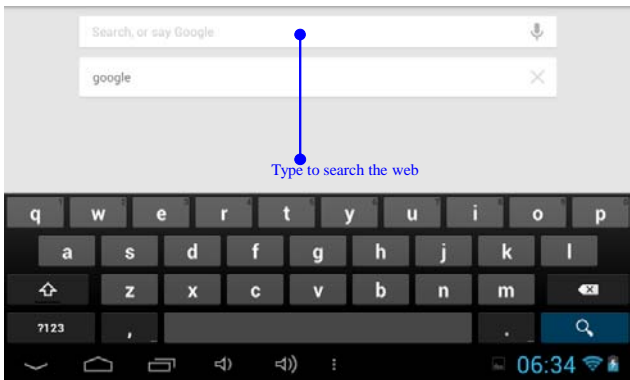

5.9. Camera

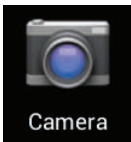





Tap

icon to enter the interface of Shooting



Do the following:

1. Tap  to take photos. It is able to save photos under the root directory—DCIM/CAMERA in the tablet.
2. Tap the  icon at the bottom right corner to switch from the shooting mode to the recording video mode. Tap  to record video.
3. Tap the  icon to select the setting of EV, White Balance, Store location and picture size

6. Downloads



Tap  icon to check the content just being downloaded.

7. Prompts and Tips

7.1 Convenient Operation Modes

To return to the desktop interface, tap  icon.

To adjust the volume, tap  icon or  icon or slide the volume

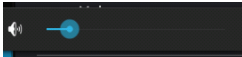
bar  to the left/ right whichever is available.

7.2 Wireless Network Connection:

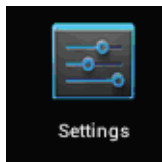

Tap icon to enter the interface of wireless network connection, shown as follows:

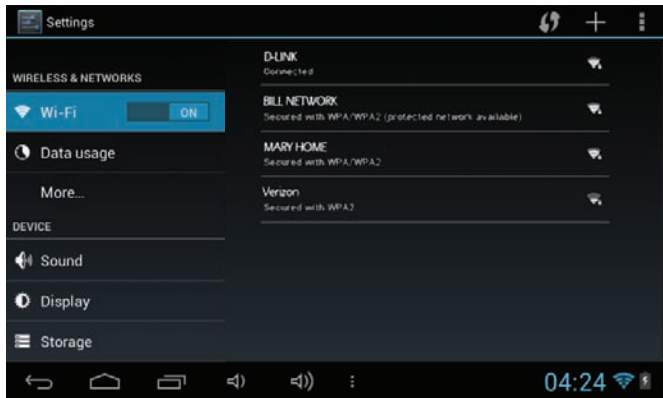

Input user name and password, and then tap “connecting” to enter the wireless network.

7.3 Tips for Battery Usage

The wide screen used by the tablet consumes a lot of power. To prolong the service time of the battery, reduce the operating frequency of the following functions.

1. Reducing Display brightness: On desktop interface, press Menu Button-System Settings-Display (display setting)-Brightness (reduce brightness).
2. Reducing Network search: On desktop interface, press Menu Button-System Settings-Wireless & networks-WIFI settings-disconnect wireless network.

8. Customized Settings

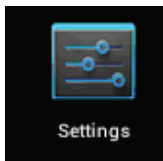

Tap icon to conduct customized setting.

8.1 Wireless and Networks

1. To open WIFI, tap to select ON option next to Wi-Fi under Wireless & Networks.
2. Select a network on the right. If required, enter the correct password and select "Connect".

8.2 Sound

Set Ringtone & notifications and volume of sound.

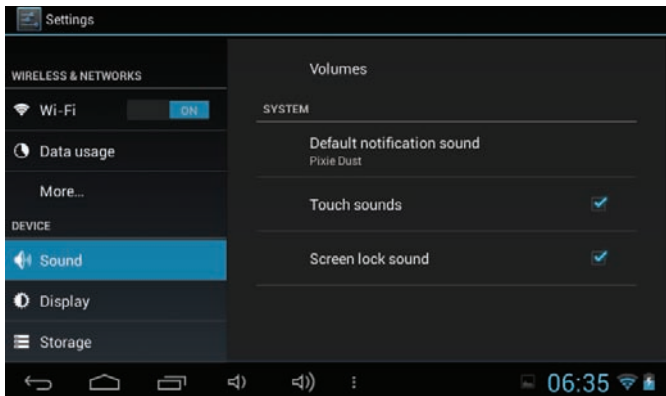

Media Volume

To set the volume of music and video, press Settings icon-Sound (sound setting)-Volumes.

Notification Sound

To set the notification sound, press Settings icon-Sound (sound setting) – Default notification.

Activating Touch Sound

To activate the screen touching with sound, press Settings icon-Sound (sound setting)-Touch sounds. Select the check box.

8.3 Display

Brightness

To adjust the brightness of the screen, press Settings icon-Display (display setting)-Brightness.

8.4 SD Card and Storage

Check the available storage space.

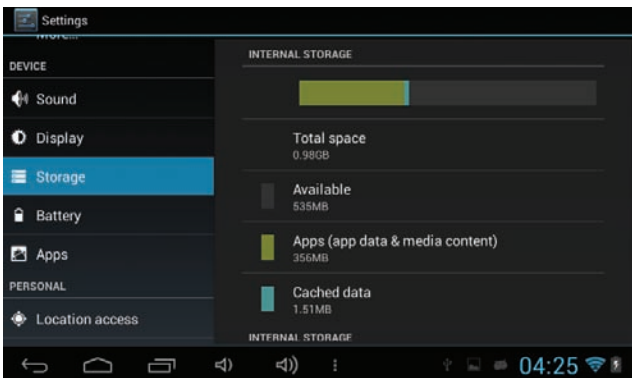

8.5 Language and Input

Set the options of language zone (language and zone) and spelling correction.

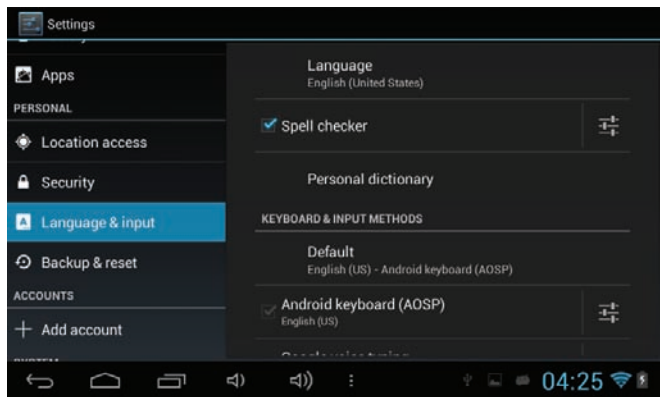

Select Language Zone

To select the language and zone, press Settings icon-Language & input-Language-Select language zone.

User Dictionary

To add/delete words from the user dictionary, press Settings icon-Language & input-Personal dictionary.

8.6 Date and Time

To set date, time, time zone, timing and form, press Settings icon-Date & time.

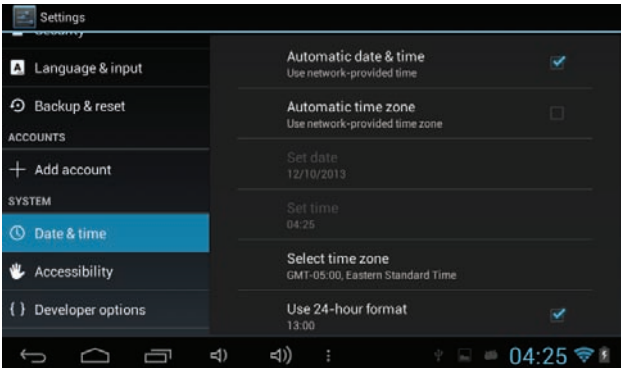

8.7 Accessibility

Auto-rotation of Screen

Enter Settings-Accessibility-Auto-rotate screen. If you select the check box, the screen will rotate when the tablet is moved.

8.8 About Tablet

Check the Status, legal information, and software version.

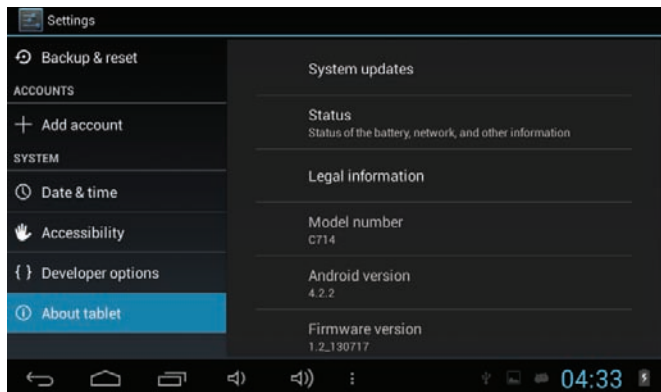

Status

To check the status of power of battery, network and other information, press Settings icon-About tablet-Status.

Legal Information

To check the legal information, press Settings icon-About tablet-legal information

Model

To check the model, press Settings icon-About tablet

9. Lock Handheld Tablet

Unlock screen/tablet:

When the system is in the status of sleep, press and release the Power key to enter the interface of screen-lock; slide up the Unlock icon to conduct unlocking and then enter the interface before system sleep.

10. Trouble Shooting

10.1 Close Application Program

Any running program will occupy certain memory, and affect the operating speed of the tablet. So, close unneeded programs in time to release occupied memory, in order to maintain normal operating speed.

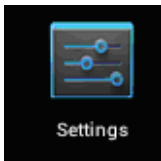

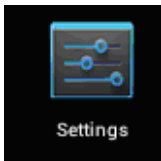
To close application program, tap  icon to enter the interface of system setting. Select Application program-Apps, shown as follows:



Tap the application program to be closed, a window will pop up to confirm whether to stop service, shown as follows:

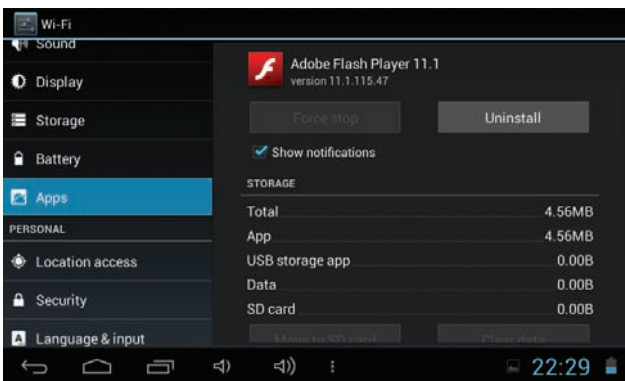

Tap Uninstall button to close the application program, the icon of which will disappear.

10.2 Forced Shutdown

Press and hold the Power key for several seconds to turn off the tablet by force.

10.3 Restore Default Settings

To restore the factory-settings and erase all data, press Settings icon-Backup & reset-Factory data reset.

Warning: After resetting the tablet, the system will delete the Google account, data and settings of the system and application programs, as well as downloaded application programs. Please use this function with extreme caution.

11. Problem solutions

Device can't turn on

1. Check the battery power.
2. Connect the adaptor first, wait for several minutes and then press Power button again.

Device can't copy or move file and so on

1. Please check if there is a correct connection between your computer and the device.
2. Verify if the memory storage space is already full.
3. Verify if the USB cable is good or not.
4. Verify if the USB connection is disconnected.

12. Basic function

Hardware configuration

Size: (length* wide*thick) 192mm x 118mm x 10.1mm

CPU processor speed: Cortex A8, 1.2GHz

Memory: 4 GB

RAM: 512 MB

TF card: Up to 32GB

Display screen: 7" (Capactive multi-touch)TFT capacitive touch

Resolution: 800*480

Camera: Front

Battery and capacity: rechargeable Built-in type lithium ion, 2800mAh

G-sensor: 3 axes

Record: built-in microphone

Operation System: Android 4.2

FCC Information and Copyright

This equipment has been tested and found to comply with the limits for a Class B digital device, pursuant to part 15 of the FCC Rules.

These limits are designed to provide reasonable protection against harmful interference in a residential installation. This equipment generates,

uses and can radiate radio frequency energy and, if not installed and used in accordance with the instructions, may cause harmful interference

to radio communications. However, there is no guarantee that interference will not occur in a particular installation. If this equipment does

cause harmful interference to radio or television reception, which can be determined by turning the equipment off and on, the user is

encouraged to try to correct the interference by one or more of the following measures:

- Reorient or relocate the receiving antenna.
- Increase the separation between the equipment and receiver.
- Connect the equipment into an outlet on a circuit different from that to which the receiver is connected.
- Consult the dealer or an experienced radio/TV technician for help.

15.19 Labelling requirements.

This device complies with part 15 of the FCC Rules. Operation is subject to the following two conditions:

- (1) This device may not cause harmful interference, and
- (2) this device must accept any interference received, including interference that may cause undesired operation.

changes or modifications not expressly approved by the party responsible for compliance could void the user's authority to operate the equipment.

FCC RF warning statement: the device has been evaluated to meet general RF exposure requirement , The device can be used in portable exposure condition without restriction.