

SONAR Phone™

BY **vexilar** MARINE ELECTRONICS

Instruction Manual Contents

[Welcome](#) [Features & Specifications](#) [WiFi Connection](#)
[Sharing a Signal](#) [SonarPhone Operation](#) [Menu Functions](#)
[Using the T-POD](#) [Installing a T-Box](#) [Portable T-Box Use](#)
[Where To Buy](#) [How To Get Help](#) [Register Your Warranty](#)

Welcome to SonarPhone

What is SonarPhone?

As the name implies, SonarPhone turns your smartphone or tablet into a fully functional touch screen sonar system that will rival the performance of sonar systems costing hundreds more. You don't need cell phone coverage to use it.

The SonarPhone Sonar Transmitter will work anywhere in the world. The SonarPhone transmitter creates its own WiFi hotspot and you can share its signal with as many people as you wish or



password protect it just for yourself.



The use of the SonarPhone App beyond DEMO mode requires a WiFi connection to a SonarPhone T-POD or T-BOX Sonar System. You can either share an existing signal or purchase a Sonar System for yourself.



SonarPhone Overview

This Depth Sounder Mobile Application is designed for amateur and professional fishermen alike. It will allow you see fish, depth and bottom contour of a body of water. This high performance sonar system, when coupled with a T-POD or T-BOX, will rival the performance of many high-cost stand-alone sonar systems.

Sonar technology is based on sound waves which are transmitted into the water. The system uses sonar to locate and define structure, bottom contour and composition, as well as depth directly below the transducer.

When in the water, the transducer (T-POD or T-BOX) sends a sound wave signal downward and determines distance by measuring the time between the transmission of the sound wave and when the sound wave is bounced off an object. Then it uses the reflected signal to interpret depth and composition of an object or bottom structure.

Choose the System That Works Best for You

Model	SP100	SP200	SP300
	T•POD Wi-Fi Transducer Pod	T•BOX Wi-Fi Boat Sonar	
			
Usage	Impact resistant chassis. Cast it or troll it.	Permanent boat installation	Portable boat installation w/ suction cup transducer bracket
Transducer	Water activated transmitter	High-speed skimmer-style transducer with 20 feet of cable	
Max depth range	120 feet	240 feet	
Sonar frequency	125 kHz Single Beam 30°	200/83 kHz Dual Beam 20°/40°	
Power source	3.7V rechargeable battery runs for four continuous hours on one charge. USB port charging system.	12V DC power	Rigid carry case holds 12V, 4.5 amp-hour battery. Charger also included.
Power output	400 watts peak-to-peak	800 watts peak-to-peak	
Transmit speed	100 Mbps	100 Mbps	
Screen controls	Touch screen controls	Touch screen, split screen display with touch screen zoom control	

(See Section: [Where to Buy](#))

Features & Specifications

SonarPhone Features

- Display Type: iPhone or iPad
- Digital Depth Indicator
- Water Temperature
- Automatic Ranging
- Fish Icon
- Depth and Fish Alarm
- Zoom Bottom Track
- Keel Offset Setting
- Noise Rejection
- Surface Clarity
- Battery Indicator
- WiFi Wireless Link

T-POD Specifications

- Depth Range Max: 120 feet (40M)
- Depth Range Min: 2 feet (0.6M)
- Sonar Frequency: 125 kHz Single Beam
- Cone Angle: 30 Degrees
- Sonar Power: 3.7V Rechargeable Battery
- Audible Alarms: Fish, Shallow, Low Battery
- Operational: -20 — 80°C
- Wireless distance: 100 Yards (90M)

T-BOX Specifications

- Depth Range Max: 320 feet (100M)
- Depth Range Min: 2 feet (0.6M)
- Sonar Frequency: 200/83KHz Dual Beam
- Cone Angles: Dual Beam 20 or 40 Degree
- Sonar Power: 12V DC power
- Audible Alarms: Fish, Shallow, Low Battery
- Operational: -20 — 80°C
- Wireless distance: 100 Yards (90M)

How to Connect to a T-POD or T-BOX

iOS Devices

1. Start the T-POD or T-BOX by powering up the T-BOX or placing the T-POD into the water. (Use a wet paper towel to power up the T-POD if at home)
2. Go to your iPhone or iPad's main "Settings" page .
3. Go to "WiFi". Your iPhone will search for new signals and should find the T-POD or T-BOX signal.
4. Select the T-POD or T-BOX that appears
5. If a master password is set for the T-POD or T-BOX, you will need to enter this password to access the signal. Tap "Join" to connect.
6. Press your iPhone's home button, then located and tap the SonarPhone icon to start the app.
7. (Optional) Tap "System Setup" to change the default SonarPhone username and password. Note that if you change the default, you will need to exit SonarPhone, return to step 2 and then re-select the T-POD or T-BOX.
8. (First Run Only) Tap "Master" and **enter the default password (12345678)** or the new password you set up in the last step.

Setup is Complete. Tap "Connect Now" to begin using SonarPhone.

Android Devices

1. Start the T-POD or T-BOX by powering up the T-BOX or placing the T-POD into the water. (Use a wet paper towel to power up the T-POD if at home)
2. Go to "WiFi" setting and be sure it is "ON". Your SonarPhone system is transmitting and WiFi signal and you should see it on your WiFi networks listing.
3. Select the WiFi SonarPhone source you wish to use, at this point if several other SonarPhone's are being used nearby, you will see them as well, but as you will soon find, they are protected by a security code the primary operator of the system. Ask them for the Security code so they can share their signal with you. If you are using the system by yourself **the WPA security code from the factory is 12345678.**
4. DO NOT leave the WiFi settings screen until you see you are connected to the WiFi channel you have selected.
5. Now you can exit the settings feature and open the SonarPhone App.
6. If you are watching another sonar system and are a "Slave" to the system, you simply hit the "Connect Now" button and enter the sonar function.
7. (First Run Only) If you are want to control the system, you will need to establish yourself as the Master. Hit the "Master" button and enter your chosen personal access code. This will insure nobody else takes control of your sonar signal. *Note: If no master is assigned, slave option will not work.*
8. Once you are the master, it will show the WiFi channel is selected on this phone or tablet you simply need to it the "Connect Now".
9. Note there is a WiFi channel signal strength screen you should note then simply hit "START" and you are now using SonarPhone.

IMPORTANT: WiFi signal range can be effected by many external factors. While good conditions allow for a 300 foot (90 meters) range, the actual distance you could experience may be plus or minus 20% of this distance.

Sharing a T-POD or T-BOX WiFi Signal

SonarPhone Master

The owner of the T-POD or T-BOX is called the Master. Only the Master can control the T-POD or T-BOX. The letter M will appear on the touch control panel when you are the Master.

SonarPhone Slave

Friends who connect and share your SonarPhone signal are called slaves. They can use the SonarPhone independently, but have some limited control. The letter S will appear on the touch control panel when you are the Slave.

Sharing a SonarPhone signal with Friends is EASY! Just ask the owner of the SonarPhone for their WPA password, so you can become a “SLAVE” to the owner or Master controller of the SONARPHONE.

Again you start in the “Settings” of you phone or tablet. Select WiFi and see what WiFi channels are available. Highlight the SonarPhone channel you wish to watch and select it and then add the WPA password from the Master and when it has been accepted and when you see you are connected to the WiFi channel you simply exit the “SETTINGS” and enter SonarPhone. Hit connect now and you are good to go!

Please realize only the Master controller has complete control of all menu functions, so you will notice some menu features simply will not function while you are a “SLAVE” to the Master of the SonarPhone signal . There is no limit to the number of “Slaves” you can have to a Master SonarPhone signal, but without a master using the system, no slave function is available.

SonarPhone Operation

Touch Pad Functions

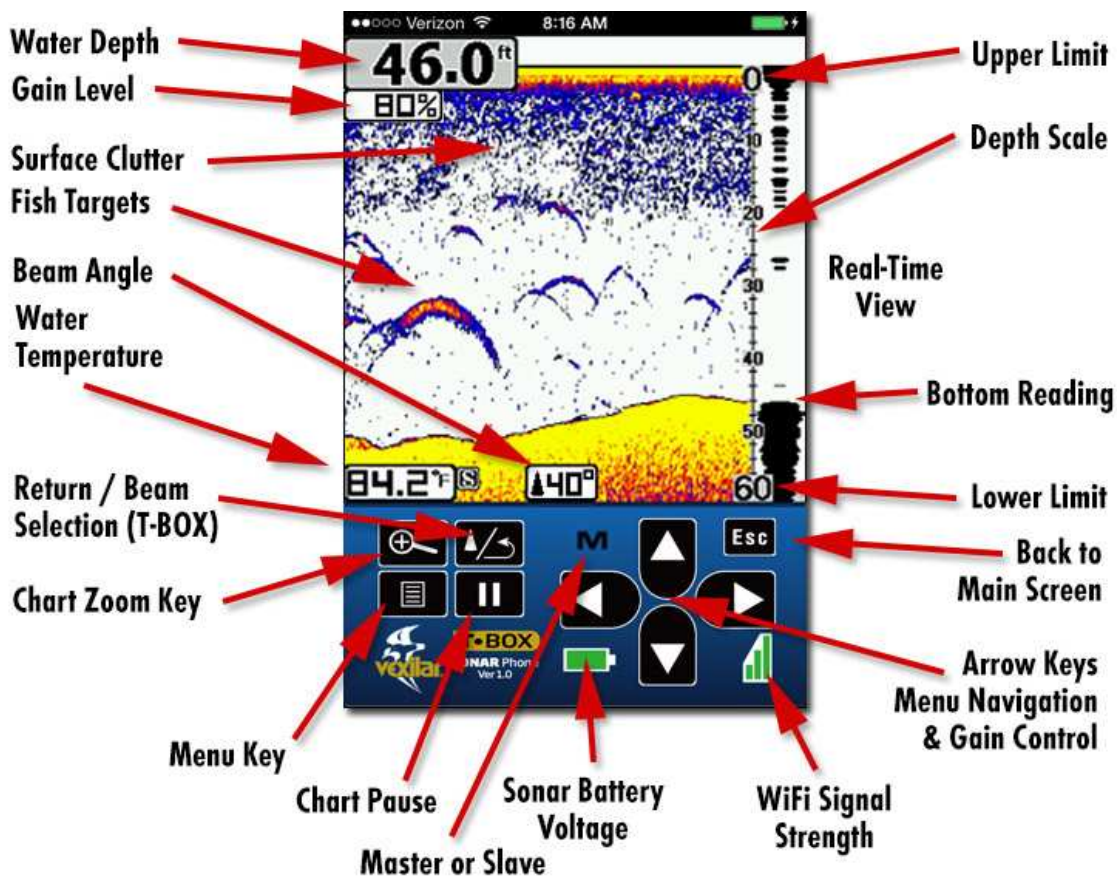

Note - The Real-Time View window always updates at the fastest rate possible. This view shows what is beneath, right now.

Split Screen Zoom View

Press the Zoom key or use the Zoom Gesture to manually enlarge the bottom signal in the main screen by 2. Press it again and the screen will be returned normal operation.

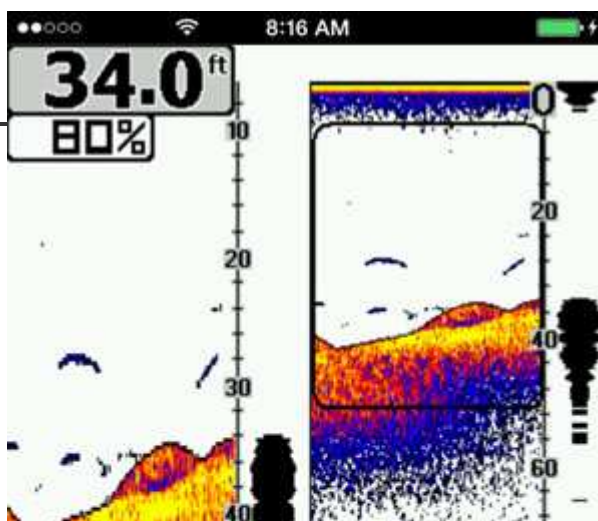

In the Split Screen Zoom View, the display is split to show the full range view on the right and the zoomed view on the left. The full range view on the right also contains the Zoom Preview Box that shows what part of the full range view is shown in zoom view on the left; the Zoom Preview Box tracks the bottom in the full range view.

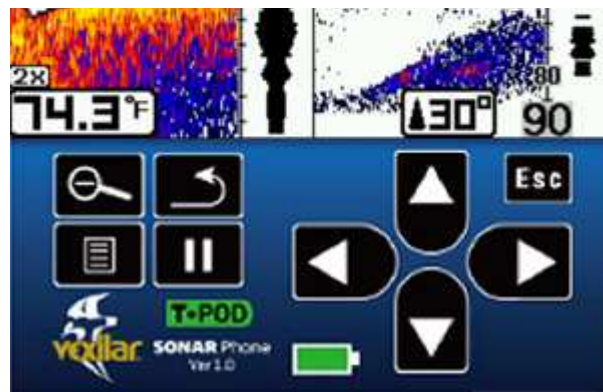

Beam Angle Selection (T-BOX Only)

Press the "Beam Angle Select / Return" button on the T-BOX touch pad. During normal operation, this button switches back-and-forth between the wide 40 degree cone and the narrow 20 degree cone.

IMPORTANT: You will need to increase the gain level while using the wide 40 degree much more than when using the narrow 20 degree beam. This is normal because

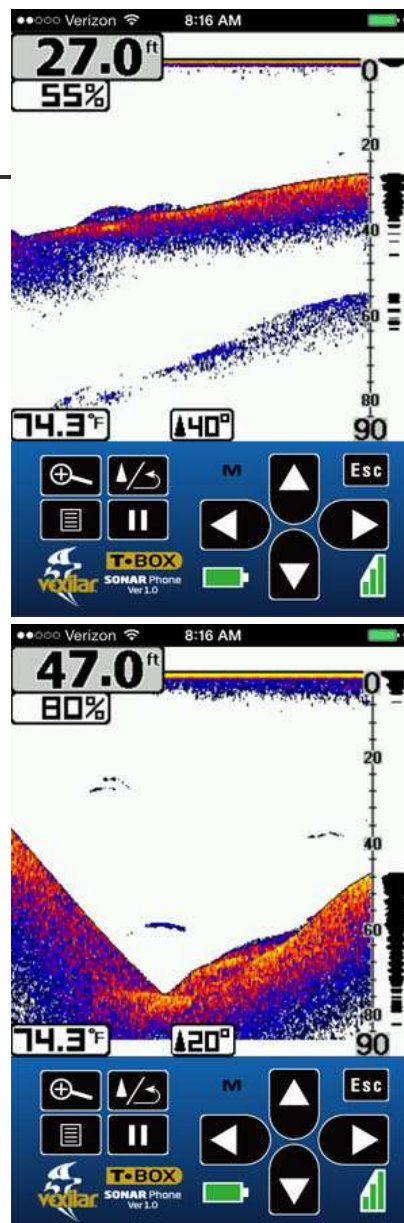

you are covering twice as much area with the wider beam.

Accessing Menu Features

Press the Menu Key to access the menu system. The menu system immediately appears on the display.

The menu system has 3 tabs: "Sonar", "Setup" and "Advanced". Tap the different Menu keys to switch between different menu tabs.

Use the Down or Up keys on the touch pad control to select a specific menu item. Then use the Left or Right keys to change a menu setting.

Press the View/Esc Key to return to the top until close menu system. Or to tap these menu items to change these settings.

Sonar Menu

Demo Mode

The Demo Mode is a very powerful tool that simulates the fish situation on the water. Use the Demo Mode to learn how to use your SonarPhone before go out on the water. All features except Depth Range may be adjusted.

Gain Control

Gain controls the unit's ability to pick up echoes, from 1% to 100%. Current gain levels are displayed below the digital depth

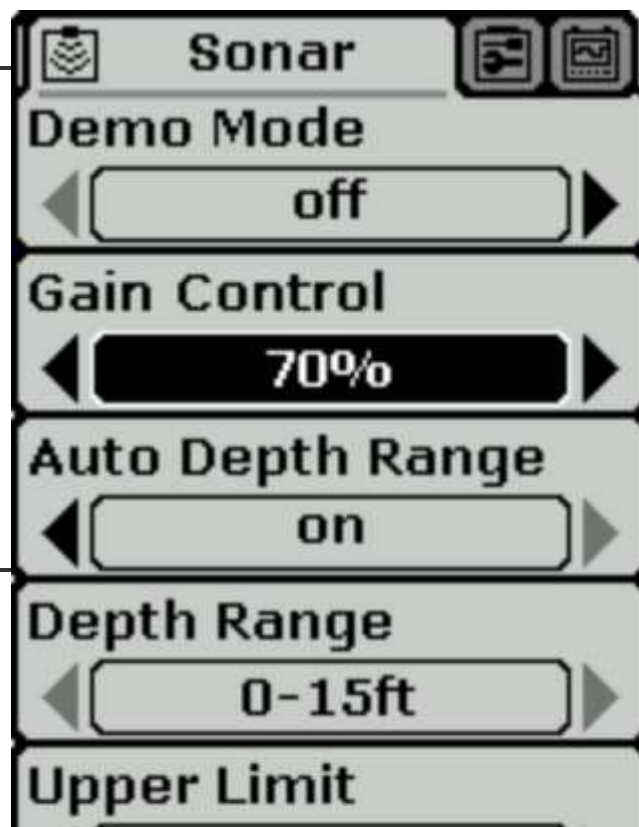

readout as a percentage of maximum (%). If you want to see more detail, increase the gain a little at a time. If there is too much clutter on the screen, decrease the gain to reduce this. Ideally, you want to set the gain to show the strongest fish echoes with the least amount of clutter. As you change the gain level setting, you can see the difference it makes on the chart as it scrolls.

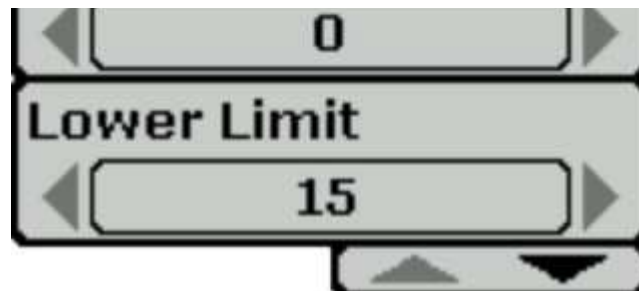

When not in the Menu mode, use the large Left and Right arrows on the touch pad to easily control the gain. If SonarPhone cannot find the depth or the return signal seems weak on the display, increase the gain level until the reading is strong.

Usually, a gain level between 30% and 60% will suffice, but increasing the gain may be required for deeper waters or very soft bottoms. For extreme shallow water, less than 3 feet, reduce the gain near the minimum setting.

T-BOX ONLY: When using the Wide 40 degree angle, you will need turn up the gain higher than when using the 20 degree angle. This is normal, as the cone of sound is covering twice the area.

Auto Depth Range

This setting allows SonarPhone to control the depth range setting for you. It will do it's best to keep the bottom in view at all times, switching depth ranges as needed. Change this setting to OFF and you can control the range setting manually.

IMPORTANT: While using manual range operation, if the depth is greater than the depth range setting, the bottom will not be visible on screen. Change the range to a deeper setting or select "Auto" to return to automatic operation.

Depth Range

This setting allows you to manually change the range setting, meaning how deep SonarPhone will read depth. The ranges available are: 0—9 feet, then 10 foot increments deeper to 120 feet (0—3 meters to 0—36 meters)

Upper Limit

The Upper Limit is the shallowest point in the water column which will be displayed on the chart.

Lower Limit

The Lower Limit is the deepest point in the water column which will be displayed on the chart.

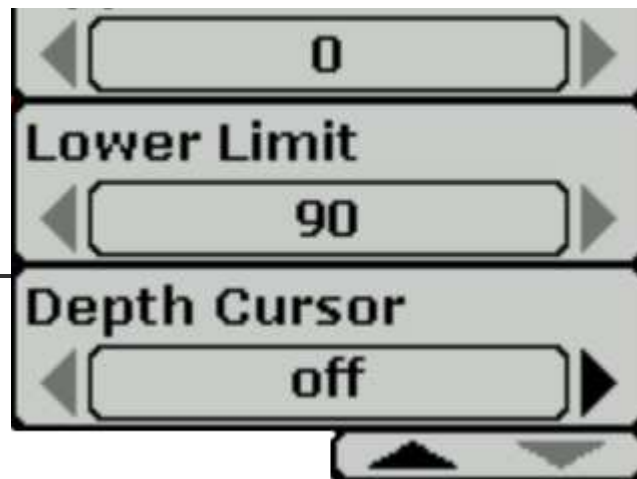

Changing the upper and lower limits give you far greater control over the depth range. This feature lets you "zoom in" the display in almost unlimited combinations.

Depth Cursor

The depth cursor, found by swiping down to the first menu page, consists of a horizontal line with a digital depth box on the right side. The numbers inside the box show the depth of the cursor. You can move the cursor to any location on the screen, letting you pinpoint the depth of a target or keep a reference point for a specific depth.

Setup Menu

Units of Measure

- Menu Settings: ft/°C, ft/°F, m/°C or m/°F

This setting allows you to configure the units of measure for your needs.

Chart Speed

- Settings: 10% to 100%

This setting changes the speed at which the display scrolls across the screen. Faster chart speeds will show longer straighter lines as fish and bottom. Slower chart speeds will show shorter, more curved lines.

Fish Symbols & Depth

Menu Settings

- On/On: Symbols and Depth are Displayed
- On/Off: Fish Symbols Only are Displayed
- Off/Off: No Fish Symbol Display

This feature identifies targets that meet certain standards for possibly being a fish. SonarPhone analyzes all echoes and eliminates surface clutter, thermoclines, and other undesirable signals. In most instances, remaining targets are fish. This feature displays fish symbols on the screen in place of the actual fish echoes. There are three fish symbol sizes used to designate the relative size between targets.

T-BOX ONLY: Fish symbols in the 40 degree cone will appear gray. Fish symbols in both the 40 and 20 degree cones will be black.

IMPORTANT: SonarPhone is sophisticated, but it can be fooled. It may not always be able to distinguish between fish and other larger suspended objects in the water.

Fish Alarm

The Fish Alarm can be configured to sound for different sizes of fish. Select the setting that is best for you.

Off - No alarm

[IMAGE] Alarm for Big Targets Only

[IMAGE] Alarm for Big and Medium Target

[IMAGE] Alarm for Any Size Target

Depth Alarm

- Menu Settings: Off
- Adjustment: 1 foot to 99 feet (1 to 30 meters)

The Depth Alarms sounds a tone and the Depth Alarm Indicator will blink when the bottom depth gets shallower than the Depth Alarm's setting.

WARNING: Do not use this feature for shallow water navigation.

Battery Alarm

When the battery voltage drops below the set value, the alarm sounds. This ensures you can tell your friends about the big fish you caught with the help of SonarPhone on Facebook before the battery goes dead.

Advanced Menu

Bottom Lock

When ON the bottom signal stays locked on bottom as you move. SonarPhone automatically adjust to keep the bottom locked into a single position. This is useful when looking for targets close to the bottom when there are heavy waves on the surface.

Keel Offset

Keel Offset will adjust the digital depth readout to indicate depth from the waterline or boat's keel instead of from the transducer position. Enter a positive vertical measurement from the transducer to the waterline. Enter a negative vertical measurement from the transducer to keel to read the depth from the keel.

Display Color Options

Select the color scheme that works best for you: White Background, Blue Background or Gray Scale.

Surface Clarity

- Menu Settings: Off, High, Medium, Low

Surface Clarity adjusts the filter that removes surface clutter noise caused by algae and aeration. The lower the setting, the more surface clutter will be displayed. Increasing surface clutter reduces SonarPhone's ability to display small targets.

Noise Filter

- Menu Settings: Off, High, Medium, Low

The Noise Filter system built into SonarPhone constantly evaluates the effects of boat speed, water conditions and interference on the clarity of your display. This automatic feature gives you the best

display possible under most conditions. If you have high noise levels, try using the "High" setting.

IMPORTANT: If you are having trouble with noise (electronic interference), we suggest that you take steps to find the interference source and correct it, rather than continually using the unit with the high setting.

Language

Select the language you can understand best: English, Spanish, German, Polish, Korean, Japanese, Chinese, Portuguese, Dutch, Finnish, Russian, Italian, Czech, Danish, French, Swedish or Greek.

Sonar Transducer Installation and Application

Before you can use SonarPhone in the water, you must understand how the sonar part of the system works (T-POD or T-BOX) so you can use it properly.

T-POD WiFi Sonar System

Using the T-POD WiFi Sonar System is simple. Just attach the T-POD to the end of a heavy fishing line and cast it into the water as you would a normal float or lure. You can also read the depth and see fish targets while you slowly reel in the T-POD or troll it behind your boat.



IMPORTANT: Ensure that the fishing line is heavy enough and the T-POD is well secured. Slip line techniques are not



recommended because of the higher risk of losing the T-POD. Also, be aware of power lines and other obstacles as you cast.

Handle the T-POD Wireless Sonar Sensor only by the top antenna cover or nose ring when it is ON. Avoid touching the bottom when active. Take extra care not to drop the T-POD while handling. Do not try to open your T-POD, it is permanently sealed.

Charging the T-POD

Before you first use the T-POD WiFi Sonar System you will need to charge it.

1. Align the plug of the charging cable with the pins on the bottom of the T-POD as in the following picture.
2. Align the USB plug of the charge cable (the longer of the two cables) with the USB socket of the power supply device (computer, adapter, etc.)
3. When charging starts the red lights inside the unit will remain On. When the battery is full, the indicator lights will be switch to green.



IMPORTANT: Be sure all of the connections are DRY, water on the stainless steel connection can create rust.

Turning T-POD ON

The T-POD WiFi Sonar System will active automatically when it is immersed in the water. The T-POD's internal GREEN indicator light when it has connected a SonarPhone app successfully. Once immersed, the internal computer will begin to start up. Give it a few seconds.



When ready, the T-POD will begin to blink, indicating it is transmitting the sonar information via radio frequency (WiFi) for the SonarPhone app to receive. Connect to it's WiFi signal using your device settings, then return to the SonarPhone app to connect to the T-POD.

You can turn your T-POD on at home and test it's functionality:

1. Dampen a paper towel with cool water.

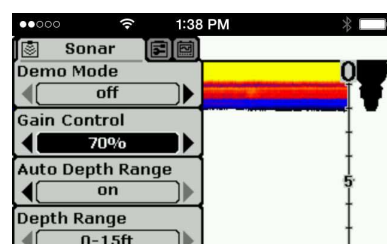

2. Bunch it up and place it against the pins on the underside of T-POD.
3. Watch as the light turns on and then begins to flicker.
4. Connect to the T-POD with your SonarPhone App. Refer to the [WiFi connection instructions](#) if needed. Make sure the GAIN is at least 70%. (You can remove the wet towel)
5. Hold the T-POD about 1 meter above a hard flat floor (not carpet).
6. Point the flat part of the bottom of the T-POD at the floor and watch for the echo to appear on your SonarPhone chart. The more perfect your aim at the floor, the stronger the echo will appear. Increase the gain level if you cannot find a floor echo.
7. The T-POD will time-out and turn itself off 30 seconds after the pins have dried.

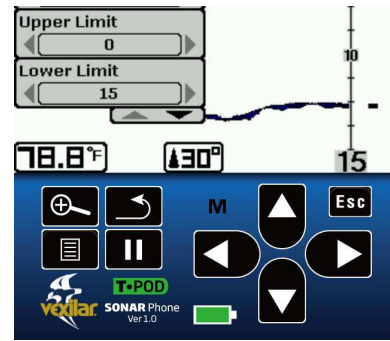

IMPORTANT: The T-POD's "Wet Switch" pins must be rinsed with fresh water after exposure to salt water to prevent corrosion.

IMPORTANT: Do not place the T-POD in a wet area or on a metal surface when not in use as this will activate the T-POD, drain its battery and help shorten its usable life. Store the T-POD in a dry area.

Resetting Your T-POD

To do this your T-pod must be OFF. Plug in your USB power adapter to power and now use the shorter of the two lead (they are marked) and plug it into your T-POD for at least 3 seconds. T-POD is now reset to factory settings. (Password: 12345678)

T-POD No Hassle Service Program

Fishing can be hard on equipment, so if you damage your T-POD (and this is NOT covered by your warranty) you can have it replaced

for a fraction of the original cost. This service also extends beyond the standard warranty period, so if five years from now the battery is fails, Vexilar's No Hassle Service Program for SonarPhone T-POD owners will be there for you, for as long as you own the product!

Here's how it works: Send us your damaged or destroyed SonarPhone T-POD along with \$60.00 US and we will send you back a replacement T-POD! No questions asked. This cost includes domestic return shipping. Some additional shipping may apply for customers outside the USA. Credit card payment is also accepted by phone. (Visa and Master Card only)

Send to:

Vexilar, Inc.
6667 West Old Shakopee Rd Suite #101
Bloomington, MN 55438 – USA
Attn: SonarPhone No Hassle Service

IMPORTANT: Be sure to include your name and return address and a phone number or e-mail address for us to contact you.

IMPORTANT: Do not try to open your T-POD, it is permanently sealed. Opening a T-POD will void the warranty.

T-BOX WiFi Permanent Installation (SP200)

To use the T-BOX system (SP200) on a boat, the T-Box and transducer must first be installed onto the boat and the proper wiring connection made.

Take a few minutes to plan your installation. The T-BOX should be mounted in a location where it will be readily accessible yet out of the way of traffic and sheltered from



severe weather exposure. The mounting surface should be fairly flat. Be sure to allow clearance for the cables. The unit is weather-proof, not waterproof, so try not to mount it in a location where it will be submerged or exposed to the extreme forces of wave impact during severe conditions.

Mounting the T-BOX

1. Obtain four appropriate fasteners for your mounting location.
2. Position the T-BOX in your intended mounting location.
3. Mark the four holes and drill each using the appropriate drill size.
4. Attach the T-BOX using your four fasteners. Tighten securely.
5. Insert the power cable jack and tighten the transducer cable connection securely. Ensure there is good clearance for the connectors.



T-BOX Power Connection

T-BOX requires a 12 volt power source to operate. A connection can be made directly to a battery or a connection can be tapped into a boat's electrical system.

If possible, power your T-BOX using the main starting battery, not a battery that powers an electric trolling motor or other potential source of electrical interference.

When routing the cable, be sure to stay away from, or provide cable protection around, areas with sharp metal edges. If the supplied power cord is too short, extend it using 18 gauge wire.

IMPORTANT: Be sure to have circuit protection, such as a 1 amp fuse or circuit breaker, placed in the positive line near the power source to protect the wiring.

Connect the T-BOX to Power

1. Be sure the power cord is not connected to the T-BOX.
2. Route the power cable from the T-BOX location to the power source.

3. Connect the red wire to the positive power source terminal and the black wire to the negative terminal.
4. Connect the power plug to the T-BOX's power jack.

Transducer Installation

The sonar transducer style that comes with T-BOX is designed to be mounted externally on the transom of your boat. It has a special wedged shape to allow clear water flow when running at high boat speed. The transducer is attached at the bottom of the boat's transom with a small portion of it extending below the hull line.

Before you begin the process of installing the transducer, check your hull to find a spot where you will have a smooth water flow along the bottom of the boat. You want to avoid ribs, rivets, and gouges or scratches in the hull. These create turbulence in the water and can scatter SonarPhone readings at high speeds.

To get a true vertical depth reading, the transducer should be mounted parallel to the water line. However, a 10° tilt to either side is acceptable. If the hull is reasonably flat with a dead rise of 10° or less, mount the transducer along the hull bottom. If dead rise is greater than 10°, mount the transducer with level alignment.

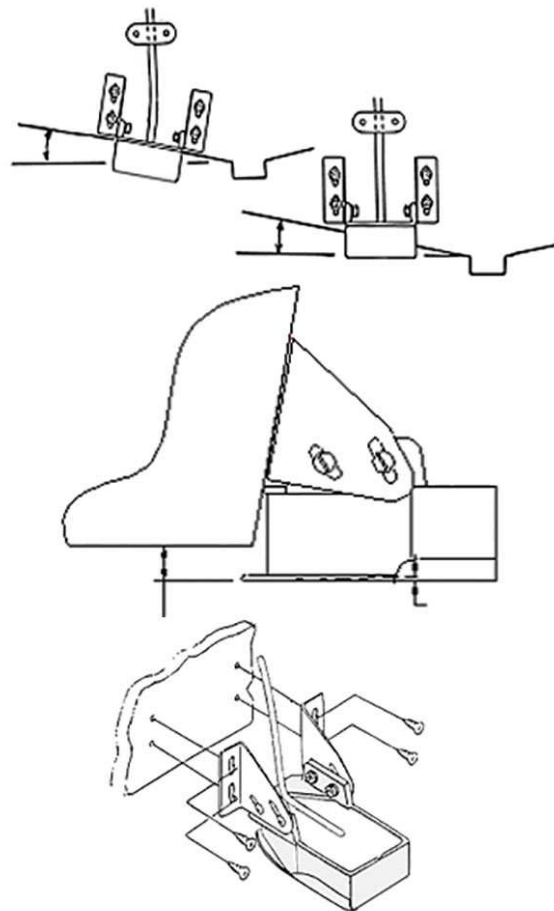

Install the T-BOX Transducer

1. Assemble the stainless steel brackets to the transducer using the hardware furnished. Do not tighten until final adjustments are made.
2. Place assembly on transom at selected location with the front of the transducer extending 1/2" to 5/8" below the bottom of the boat

and with the front part against the transom. The least amount that the transducer extends below the bottom is desired. If too low, spray and turbulence will occur resulting in lost bottom readings.

3. With transducer in place, mark the two slot locations of the transducer mounting brackets. Drill in center of slot outline using a 1/8" (.125") drill.
4. Fasten the transducer to the transom using the #8 x 1/2" screws, nuts and washer plates.
5. Before final tightening the 2 screws holding the brackets to the transducer, tip the rear edge down approximately 1/8" as shown.
6. Tighten all screws.

CAUTION. Do not use any thread locking compound on the screws. Most products such as Loctite® contain chemicals that attack and weaken plastics.

Turning the T-BOX On

Press the master ON/OFF switch on the side of the T-BOX. It will light up showing the system now has power. When it starts to randomly flash, this lets you know the system is now transmitting a WiFi signal.

To Turn it off, press and hold the button (5 seconds) until the light goes out.

Resetting the T-BOX

When the system is ON, press the Power Switch three times, quickly within 3 seconds. The system will power OFF if the re-boot was successful. Turn it on again. Now the name and password will be back to factory default: **12345678**

T-BOX WiFi Portable WiFi Sonar System (SP300)

The SonarPhone T-BOX Portable System (SP300) includes a



convenient carrying case system in which the T-BOX is mounted to. It contains a rechargeable 12 Volt battery and a suction cup style transducer mounting system. This allows you to use SonarPhone on a boat, without the need for the installation steps. A suction cup attaches the transducer to the boat.



Attaching the Suction Cup Transducer

1. Unwind the cable from the carrying case and set the transducer system near the back of the boat.
2. Find a smooth spot on the outside and near the bottom of the transom. Try to find a place where the water flow will be smooth when the boat is going fast. You want to avoid ribs, rivets, and gouges or scratches in the hull. These create turbulence in the water and can scatter SonarPhone readings at high speeds.
3. Wet the face of the suction cup slightly, then press it firmly against the transom of the boat. Slide it into the best position you can see.
4. Pull on the suction cup to ensure that it is holding securely, then route the transducer cable up to the carrying case. Restrain the cable so that it does not become tangled in the propeller or the motor workings.

IMPORTANT: Suction cups can come loose. Be sure to take the time to tie a rope to the transducer bracket and then to the boat leaving as little amount of slack as you can. If the cup comes lose, this will keep your transducer and cable out of the propeller.

Turning the T-BOX On

Press the master ON/OFF switch on the side of the T-BOX. It will light up showing the system now has power. When it starts to randomly flash, this lets you know the system is now transmitting a WiFi signal.

Charging the Battery

Allow the battery to warm up before charging. This makes it easier for the charger to charge the battery and the battery is more accepting of a charge.

1. Plug the charger into a wall outlet, verify that it is operating by noting the illuminated GREEN light.
2. Connect the charger to the Easy Charge Jack on the T-BOX. The charger's light will switch to RED, indicating that it is connected correctly and the battery is charging.
3. Keep the charger plugged in and connected until the RED light has changed to GREEN. This indicates the battery is at full charge.
4. Unplug the charger from the wall outlet and disconnect from the battery.

Charging times will vary depending on how much the battery has been drained. If the battery has been completely drained the battery will require about 4 hours of charging. Once the battery is fully charged and the charger's light returns to GREEN, the charger is then operating in a "Maintenance Mode". At this stage, the charger can remain connected to the battery indefinitely and the battery will be maintained at full charge.

Where to Buy

Vexilar has a wide network of sporting goods dealers. For a complete list and nearest location finder, please visit <http://vexilar.com/apps>

Where to Get Help

If you have problems or questions, please visit our support website: <http://vexilar.com/apps/support>

FCC Warning Statement

Changes or modifications not expressly approved by the party responsible for compliance could void the user's authority to operate the equipment.

This equipment has been tested and found to comply with the limits for a Class B digital device, pursuant to Part 15 of the FCC Rules. These limits are designed to provide reasonable protection against harmful interference in a residential installation. This equipment generates uses and can radiate radio frequency energy and, if not installed and used in accordance with the instructions, may cause harmful interference to radio communications. However, there is no guarantee that interference will not occur in a particular installation. If this equipment does cause harmful interference to radio or television reception, which can be determined by turning the equipment off and on, the user is encouraged to try to correct the interference by one or more of the following measures:

- Reorient or relocate the receiving antenna.
- Increase the separation between the equipment and receiver.
- Connect the equipment into an outlet on a circuit different from that to which the receiver is connected.
- Consult the dealer or an experienced radio/TV technician for help.

FCC Radiation Exposure Statement

The antennas used for this transmitter must be installed to provide a separation distance of at least 20 cm from all persons and must not be co-located for operating in conjunction with any other antenna or transmitter.

*Software Engineering by [Phiradar Technology Co., LTD](http://www.phiradar.com)

Phiradar[®]

[Welcome](#) [Features & Specifications](#) [WiFi Connection](#)
[Sharing a Signal](#) [SonarPhone Operation](#) [Menu Functions](#)
[Using the T-POD](#) [Installing a T-Box](#) [Portable T-Box Use](#)
[Where To Buy](#) [How To Get Help](#) [Register Your Warranty](#)
