

DAKEWE

HP300 Plus

Automatic Tissue Processor

User's Manual



CE

Revision V1.4-English Version- Jan. 2023

[Product Name] Automatic Tissue Processor

[Product model] HP300 Plus

[Production Date] Seen in label

[Manufacturer Name] Dakewe (Shenzhen) Medical Equipment Co., Ltd.

[Registered Address] Floor 5, Building B, No.2 Luhui Road, Jinsha Community, Kengzi Street,
Pingshan District, Shenzhen,China.

[Production Address] Floor 5, Building B, No.2 Luhui Road, Jinsha Community, Kengzi Street,
Pingshan District, Shenzhen,China.

[After-sales Service Organization] Dakewe (Shenzhen) Medical Equipment Co., Ltd.

[After-sales Service Organization] Floor 5, Building B, No.2 Luhui Road, Jinsha Community,
Kengzi Street, Pingshan District, Shenzhen,China.

[TEL] 0755-26413421

[Fax] 0755- 27383156

[Website] <http://www.dakewemedical.com/>

Foreword

Dear user,

Thank you for choosing our product!

In order to make you have an overall understanding of the Company's product to facilitate your use. We have specially configured this User Manual to the instrument, which includes the instrument's structural features, technical characteristics, instructions for use, simple troubleshooting, maintenance, etc. For your ease of use this instrument.

Before use, **be sure to** read the User Manual carefully and follow the instructions correctly to the user manual. In addition, if you have any questions during use, contact technical support, we will be glad at your service.

Important Statement

The information, data, and precautions etc. contained in this Manual only represent the scientific knowledge and advanced technologies that we currently possess through the institutes in this field. Dakewe (Shenzhen) Medical Equipment Co., Ltd. reserves the right to make changes to the manufacturing process subject to regulatory requirements without prior notice. In this way we can continuously improve the technology and manufacturing techniques used in our products.

For the error descriptions, charts, technical illustrations, etc. contained in this Manual, organizations or personnel are encouraged to give us feedback for updating. It is also important to note that we shall not be liable for any direct or indirect economic loss or damage caused by **non-compliance** with statements or other information in this Manual.

This document is protected by copyright law and all copyright in this document belongs to Dakewe (Shenzhen) Medical Equipment Co., Ltd. Copying the text and illustrations (or any part thereof) of this document by printing, photocopying, microfilming, webcam or other methods, including any electronic systems and media, requires prior written permission from Dakewe (Shenzhen) Medical Equipment Co., Ltd.

For the instrument serial number and year of manufacture, check the nameplate on the back of the instrument.

Table of Contents

1. Information	4
1.1 Symbol and Meaning	4
1.2 Instrument Use	6
1.3 Working principle	6
1.4 Personnel Qualification	6
1.5 Instrument Model	6
2. Safety	8
2.1 Safety Precautions	8
2.2 Warning	9
2.2.1 Warning - Signs on the instrument	9
2.2.2 Warning – Transport	10
2.2.3 Warning – Installation	10
2.3 Safety Functions on the Instrument	12
2.3.1 Pressure Monitoring	12
2.3.2 Temperature Monitoring	12
2.3.3 Flow Monitoring	12
2.3.4 Component Monitoring	12
3. Instrument Components and Specifications	13
3.1 Overview	13
3.2 Main Characteristics of the Instrument	14
3.3 Technical Parameters	18
3.4 Compatible Reagents	20
4. First Installation	21
4.1 Installation Requirements	21
4.2 Unpacking and Installation	21
4.3 Host / Hardware	24
4.3.1 Installing the Monitor	24
4.3.2 Color LCD touch screen	25
4.3.3 Dehydration Cylinder	25
4.3.4 Active Carbon Filter	28
4.3.5 Exhaust Pipe (optional)	29
4.3.6 Marble Workbench	29
4.3.7 Tissue Sample Basket	29
4.3.8 Paraffin Cylinder	30
4.3.9 Waste Paraffin Collection Tray	31
4.3.10 Reagent Compartment and Reagent Bottle	32
4.3.11 Reagent Bottle Label	33
4.3.12 Reagent waste liquid collection module	34
4.3.13 Reagent automatic liquid change	34
4.3.14 Cleaning xylene pre-heating	35
4.4 Alarm Function	35
4.5 Main Power Supply and Power Jumper Connection	36
4.6 Instrument Startup and Login	36

4.7 Touch Screen Functions	39
4.7.1 Screen lock	39
4.7.2 Screen Protection	40
4.8 Turn off the instrument	40
4.9 Instrument handling	41
5. Instructions before use	42
5.1 Access Level	42
5.1.1 Device Status Indicatio	42
5.1.2 Main Interface	42
5.1.3 Soft Keyboard	43
5.2 Access Level	44
5.3 Account login	45
5.4 User Interface	46
6. Menu module	47
6.1 Basic Function	47
6.2 Relevant Settings	59
6.3 Advanced Module	67
7. Reagent Processing	73
7.1 Reagent Filling / Evacuation / Replacement	73
7.2 Paraffin Filling / Evacuation / Replacement	75
7.3 One-button automatic fluid change	78
8. Start Program	79
8.1 Manual Running of the Dehydration Program	80
8.2 Program Operation Panel	85
8.3 End Program	86
9. Cleaning and Maintenance	87
9.1 Rinse Program	87
9.1.1 Rinse Process Step Operation	88
9.1.2 Rinse Process Precautions	88
9.2 Regular Rinse	90
9.2.1 Daily Cleaning and Maintenance	90
9.2.2 Weekly Cleaning and Maintenance	90
9.2.3 Monthly Cleaning and Maintenance	93
9.2.4 Reagent Rinse	93
9.3 Regular Maintenance	94
10. Troubleshooting	95
10.1 Fault Alarm Type	95
10.2 Troubleshooting	95
10.2.1 Power Failure	95
10.2.2 Safety Protection Reagent	96
10.2.3 Electronic Lock	96
11. Warranty and Service	97
11.1 Warranty	97
11.2 Technical Service Information	97
11.3 Scrapping and Disposal	97
12. Hazardous Substance Information	98

13. Electromagnetic Compatibility Indicators	99
14. RFID-Registration for the United States of America and Canada	101

1.Information

1.1 Symbol and Meaning



Danger:

Indicating an urgent dangerous situation that, if not avoided, will result in death or serious injury.



Warning:

If you do not avoid this danger, it may result in death or serious injury.



Caution:

Indicating a potentially hazardous situation that, if not avoided, may result in death or serious injury.



Note:

Indicating information that is not related to risk but is very important.



Follow this User Manual.



IVD medical device



The symbol indicating separate collection for waste electrical and electronic equipment



Power on



Power off



Biohazard warning (black line on yellow background)



Sign indicator of using flammable solvents and reagents (black line on yellow background)



This warning symbol indicates the instrument surface that will be hot during operation. Avoid direct contact to prevent burns.



Environmental protection sign of RoHS Directive. The figure in the symbol refers to the product's number of years of "environment-friendly use". Use this symbol if the use of a restricted substance exceeds the maximum allowable limit.



Indicating that users are required to consult the User Manual for important warning information, such as warnings and precautions.



Serial number



Manufacturing date



Manufacturer



No stacking



Limited height of 2 floors (accessory cases only)



Indicating the correct vertical position of the packing container.



Goods are fragile and must be handled with care.



The package must be stored in a dry environment.



Recycle in accordance with local laws and regulations.



Item indication number in the illustration.



Anti-tilt mark: it must be kept upright during transportation, and flow crystal sand overflow occurs after 45° tilt.



Shockproof label: put it carefully during transportation. After impact, the display bar will turn red



Unique Device Identifier



Importer



The CE marking is the manufacturer's declaration that the medical product meets the requirements of the applicable EC directives and regulations



UKCA mark



Name and Address of UK responsible person



FCC ID: 2A9670204

FCC-Approved Equipment

1.2 Instrument Use

The automatic tissue processor is used for dehydration of samples prior to pathological analysis and is intended for use in pathology laboratories only to perform the following tasks:

- Fixation, dehydration, transparency and wax immersion treatment of tissue samples;
- Only operate the instrument as described in this Manual.

Any other ways of use are regarded as inappropriate!

1.3 Working principle

The user puts the specimen with tissue into the tissue processing tank of the instrument, and then clicks to start the pre-set dehydration program. The dehydrator will extract the reagents into the tissue tank one by one according to the dehydration program set by the user for soaking treatment. Each step can be individually set for dehydration time, temperature, pressure mode and other parameters. After the program is executed, the dehydrator will automatically prompt the user to remove the specimen in time.

1.4 Personnel Qualification

- Only trained laboratory staff can operate.
- Only operate the instrument as described in this Manual.

1.5 Instrument Model

The serial number (SN) of the instrument is on a nameplate attached to the back of the processor.

Software release version: V01

As described in nameplate



**Be sure to observe the safety instructions and warnings in this Chapter.
Even if you are already familiar with the operation and use of the product, be sure to read these instructions.**

2.Safety

2.1 Safety Precautions

This User Manual contains important information related to operational safety and equipment maintenance.

As an important part of the product, the User Manual must be read carefully before installation and use, and always be placed near the instrument.

This instrument is manufactured and tested in accordance with the safety requirements of electrical equipment for measurement, control, and laboratory use. The product meets the following safety and EMC testing standards:

- (1) IEC61010-1:2010+A1:2016 Safety requirements for electrical equipment for measurement, control, and laboratory use - Part 1: General requirements.
- (2) IEC61010-2-101: 2018 Safety requirements for electrical equipment for measurement, control and laboratory use - Part 2-101: Particular requirements for in vitro diagnostic (IVD) medical equipment.
- (3) IEC61326-1: 2020 Electrical equipment for measurement, control and laboratory use - EMC requirements - Part 1: General requirements.
- (4) IEC61326-2-6: 2020 Electrical equipment for measurement, control and laboratory use - EMC requirements - Part 2-6: Particular requirements - In vitro diagnostic (IVD) medical equipment.

Most of the reagents used with the processor are flammable. Do not allow any source of ignition to enter or come close to the instrument after loading the reagents.

In order to maintain this condition and ensure safe operation, the user must comply with all safety precautions and warnings in this User Manual.



- **Always observe the safety and precautions described in this Chapter.**
- **Even if you are already familiar with the operation and use of other Dakewe products, be sure to read these instructions.**
- **Do not remove or modify the protective devices of the instrument and accessories. Only Dakewe-certified qualified maintenance personnel can repair the instrument and dispose of the instrument's internal components.**
- **The instrument is designed and manufactured with advanced technology and complies with relevant safety technical standards and specifications. Improper instrument operation or handling can result in injury to the user or other personnel, damage to the instrument and other property damage. The instrument must be used for its intended use and only when all safety functions are in proper working condition. Faults that are detrimental to safety must be corrected immediately.**
- **Only use original spare parts and permitted original accessories.**



Do not remove or modify protective devices of the instrument and accessories. Only authorized maintenance personnel are allowed to repair the instrument and dispose of the instrument's internal components.

2.2 Warning

The safety device installed by the manufacturer on this instrument only constitutes the basis of accident prevention. The primary responsible party for the safe operation is the organization, followed by the personnel assigned by the organization to operate, maintain or repair the instrument. In order to ensure the smooth operation of the instrument, be sure to observe the following instructions and warnings.

2.2.1 Warning - Signs on the instrument



The warning triangle is displayed on the instrument to ensure that correct operating instructions defined in this Manual must be observed during operation and replacement. Failure to follow these instructions may result in accidents, personal injuries, and damages to the instrument or accessories.



The surface of the instrument that will become hot during operation is marked with this warning label. Touching the surface marked on this warning label may cause burns.

2.2.2 Warning – Transport



The instrument must be transported by the casters at the bottom, and one person is required to push the instrument.

Pushing the instrument down from the packing box requires the use of the slope attached to the packing box, which requires two people to cooperate.

The instrument must be parked on a level bottom surface, and the brakes of the casters must be locked after parking.

After opening the package, the instrument must be moved upright.

Strictly follow the instructions for opening the package to avoid damage to the instrument! The instrument may be shaken, tilted or lifted during transportation, so before each transportation, the instrument must be emptied, including pipes, wax baths and reagent bottles-otherwise the instrument will be damaged.

2.2.3 Warning – Installation



Observe the instructions for unpacking carefully to avoid damaging the instrument!

During transportation, the instrument may be shaken, tilted or lifted. Before each transportation, the instrument must be drained, including piping, paraffin cylinder and reagent bottle. Otherwise, the instrument may be seriously damaged.

Only insert the instrument into a securely grounded power socket. Make sure to use CB (circuit breaker).

If the instrument is connected to a main power supply with a different voltage from the indicated voltage on the nameplate, it may result in serious damage to the machine.

The installation site must be well ventilated. There is no type of flammable ignition source.

High temperature fluctuations and high humidity between storage facilities and installation sites may result in condensation. If this happens, you must wait at least two hours before turning on the instrument. Violation of this requirement will damage the instrument.

2.2.4 Warning - Reagent processing



Be very careful when handling reagents!

Rubber gloves and goggles must be worn when handling chemicals used in this instrument.

Dispose of reagents carefully in accordance with regulatory requirements and the waste

2.2.5 Warning - Operation



The processor can only be operated by trained laboratory personnel according to the intended use in this User Manual.

In case of emergency, turn off the main power supply and unplug the power cord.

Appropriate protective device to include lab coat, gloves and goggles must be worn when operating the instrument.

Make sure that the instrument being operated is equipped with a strainer or exhaust pipe.

Even if the instrument is operated according to the specified purpose, dangerous solvent flames can also be produced, which may harm the operator's health and cause fire!

If need to interrupt the dehydration procedure for a long time, do not leave any tissue in the processing cylinder to prevent the tissue from drying out.

2.2.6 Warning - Cleaning and maintenance



Before each maintenance or cleaning, the instrument shall be **TURNED OFF** and the main power supply shall be disconnected. **DO NOT** use any solvents that contain acetone or xylene to clean the instrument. Avoid liquid spillage on the internal components of the instrument, including during operation and cleaning.

When using detergents, all safety requirements and laboratory management policies of the product manufacturer shall be observed.

In any case, **DO NOT** flush the sites at high temperature. Otherwise, the sites may be deformed!

Spilled solvents (reagents) must be wiped off immediately. Failing to do so could result in corrosion of the processor!

In order to clean the lid, control panel and housing, use a mild household cleaner (such as neutral soapy water).

2.3 Safety Functions on the Instrument

The Dakewe HP300 Plus Automatic Tissue Processor is equipped with numerous safety functions, and powerful software controls. It possesses a unique quality control function of **components**, which can predict the operating status of the system, detect problems in advance and process accordingly, so as to ensure that the samples will not be damaged in the event of failure in the program. This feature enables the successful completion of the program.

2.3.1 Pressure Monitoring

- The instrument is equipped with pressure monitoring function, which is able to automatically stop the pump action when the pressure is abnormal.
- The system records the pressure setup time of each pressure setup process in the quality control interface. The system automatically analyzes the change in pressure setup time and system operation condition, and predicts the failure in advance.

2.3.2 Temperature Monitoring

- Temperature control adopts multi-point acquisition and temperature protection switch for temperature control and protection. Multi-point temperature control improves the temperature control accuracy and safety factor. The temperature protection switch, effectively prevents high temperature anomalies.

2.3.3 Flow Monitoring

- The dehydration process utilizes flow monitoring. The system records the time spent in each extraction and drainage, and automatically compares and analyzes the system operation condition according to the standard time in order to predict the occurrence of failure in advance.

2.3.4 Component Monitoring

- The use time of key components of the HP300 Plus Automatic Tissue Processor is monitored and recorded, including rotary valves, electromagnetic valves, air pumps, seal rings and electronic chips. It is able to perform real-time recording and analysis of the operational condition of system components, and predict the occurrence of failure in advance.

3. Instrument Components and Specifications

3.1 Overview

The automatic tissue processor consists of a dehydration module, which consists of a control system, a sample transfer system, a retort, and a paraffin tank.

The processor is principally composed of a hardware control system, a fluid system, a sample transmission system, a dehydration cylinder, a paraffin cylinder, an airway module, and a man-machine interactive system, etc.



Figure 2 Front of HP300 Plus Automatic Tissue Processor

- | | |
|--|-------------------------------------|
| 1 Dehydration cylinder | 10 Waste Collection Tray |
| 2 Tissue sample basket | 11 Caster (4) |
| 3 Electronic lock and manual opening knob for dehydration cylinder lid | 12 Reagent compartment's glass door |
| 4 USB port | 13 Reagent bottles (14) |
| 5 Automatic fluid change connector | 14 Host |
| 6 Active carbon filter | 15 Workbench area |
| 7 Paraffin cylinders (4) | 16 Power switch |
| 8 Paraffin case door | 17 12.1inch color touch LCD screen |
| 9 Waste paraffin collection tray | |

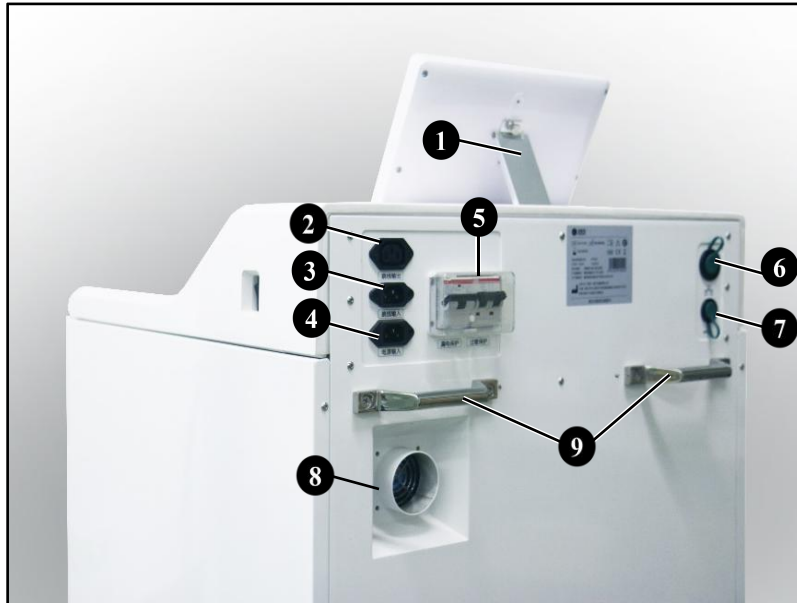

Figure 3 Back of HP300 Plus Automatic Tissue Processor

- | | |
|-------------------------------------|-------------------------|
| 1 Display regulating support frame | 6 Network port |
| 2 Power jumper output | 7 USB port |
| 3 Power jumper input | 8 Exhaust gas interface |
| 4 Power input | 9 Handle to move |
| 5 Leakage current protection switch | |

3.2 Main Characteristics of the Instrument

- HP300 Plus is equipped with a 12.1-inch LCD touch screen. The screen can be adjusted in three stages to adapt to different user habits.
- The user interface displays the dehydration process in animation and clearly shows the details and progress of all the steps. The menu level of the software is at most two layers. The operation is user friendly.
- HP300 Plus is pre-installed with three validated dehydration processes for small tissues, standard tissues and standard tissues overnight, and are not editable. Three rinse processes are included, namely fast rinse, standard rinse and warm rinse processes, which are used to clean the residues in different situations, respectively.
- Up to 100 user-definable dehydration processes available. Each program has up to 13 steps for user defined configuration (temperature, time, reagents, pressure / vacuum and stirring options).
- Automatically run the self-check function before the program runs, check the main functional parts of the equipment in advance, and give early warning of the abnormal state of the equipment in time to ensure the normal operation of the dehydration program.
- There are lights on the front of the dehydrator to indicate the current status of the

equipment. Green means the equipment is in normal state, yellow means the equipment is in the self-checking state, and red means the equipment is in the pre-warning state, which is convenient for users to understand the state of the dehydrator simply and intuitively.

- With reagent management system (RMS), users can monitor the use of reagents based on the number of cassettes, dehydration cycles or dehydration days.
- There are three ultrasonic liquid level sensors in the tissue processing cylinder. Two of them are used for liquid level detection. The top one is used to monitor and prevent liquid overflow. The principle of ultrasonic detection is highly reliable, and it is not easy to cause false alarms due to the accumulation of impurities on the probe surface.
- The retort is equipped with a high reliability concentration detection sensor for reagent concentration monitoring, which can detect the concentration of ethanol and other reagents.
- The cylinder lid of the tissue processing cylinder is automatically locked and opened by the electronic lock, and is equipped with a double triggering device, so as to ensure the safety and reliability of the cylinder lid locking.
- The cylinder lid of the tissue processing cylinder has a heating effect, which can prevent liquid from condensing on the inner wall of the cylinder lid during the dehydration process, thus reducing cross-contamination and loss of reagents. The inner wall of the cylinder lid is also coated with a Teflon plating layer, which serves to reduce the residual adhesion of paraffin and reagent on the surface of the cylinder lid, facilitating the cleaning of the inner wall of the cylinder lid.
- The operator can choose two dehydration process modes of delay start or immediate start, allowing for flexibility of the workflow.
- The reagent bottle has position detection and blue light indicator, which serve to monitor whether the reagent bottle is in the right place or not, and allows for easy observation of reagent level. To ensure the normal operation of the dehydration program, the blue light transmission function can make the liquid level in the reagent bottle clearly visible, which is convenient for users to observe.
- The HP300 Plus Processor has a total of 4 paraffin cylinders, among which the volume of 3 paraffin cylinders is 4.2L. The 4th paraffin cylinder is a paraffin filling cylinder with a volume of 5.6L. The wax bath has two scale lines for easy observation of the liquid level. The paraffin cylinder can be supplemented or replaced if the paraffin in other paraffin cylinders is insufficient or replaced, without affecting the normal dehydration process.
- The equipment has independent liquid and gas passages. The pumping pressure is about -40kpa and the discharge pressure is about 30kpa.
- The equipment is equipped with an innovative paraffin purification feature for removing solvent residue in wax, extending its service life.

- Reagent Bottle Intelligent Identification System (RBIIS): identification module built in every reagent bottle enables auto reagent information extraction and position detection to streamline reagent management
- The equipment is equipped with cleaning xylene pre-heating function, the heating module under cleaning xylene bottles can heat reagent to 40 - 55°C, further improving cleaning performance and efficiency.
- The equipment is equipped with remote fill & drain function, the reagent ports exclusively for easy and automatic remote fill& drain. Following auto pipe cleaning eliminates cross-contamination.
- Harmful reagent vapor, after being condensed, is filtered through an active carbon filter before being discharged into the air. In addition, the gas can be discharged outside through a separate interface on the back of the instrument.
- It has four auxiliary dehydration functions such as normal pressure, pressurization, vacuum, pressurization and vacuum alternately. It also has a stirring function, which can promote the exchange of reagent liquid and ensure uniform concentration distribution of soaking reagent.
- The rotary valve made of ceramic material is used for reagent distribution, which has good reagent compatibility and long service life; at the same time, the rotary valve has a thermal insulation design to avoid the risk of clogging of the valve hole.
- Each dehydration cylinder can hold up to 300 standard cassettes using 2 sample baskets. Each basket can hold up to 150 standard cassettes. A single basket can hold 150 cassettes and a maximum of 2 baskets; a single basket can hold 70 cassettes and a maximum of 4 baskets.
- The equipment has a remote monitoring function, which can monitor the operating status of the machine remotely. At the same time, it can automatically analyze the operating status of the equipment and transmit the data to the cloud server. Users can pay attention to the operating status of the equipment in real time and receive abnormal warnings in time.
- Users can transfer all the dehydration programs and logs via USB.
- A multi-level password protection system can prevent unauthorized access to the instrument.
- Users can adopt the “reagent / paraffin liquid level check” function to ensure the connection status of the reagent bottle.
- If a power failure occurs, the alarm system will be triggered, promoting the HP300 Plus to provide recovery measures after a power interruption.
- If an error occurs, an alarm sounds immediately. The system will try to recover first, and if it is not successful, the instrument will use a safety reagent to fill the dehydration cylinder if the monitor is not operating within 20min, to ensure sample safety.
- There are two alarm modes in total: local alarm and remote alarm to alert the user when

necessary.

3.3 Technical Parameters

Convention	Parameter
Supply voltage and frequency	100-120VAC,60Hz or 220-240VAC,50/60Hz
Main fuse	/
Power consumption	1200VA
Operating temperature range	+10°C to +40°C
Transport temperature range	-20°C to +50°C
Storage temperature range	+5°C to +50°C
Relative humidity for transport and storage	10% to maximum 85%, non-condensing
GB 4793.1 classification	Pollution level 2 Over-pressure category II
Operating altitude	Up to 2,500m above sea level
A weighted noise level	< 70 dB (A)

Size and weight	Parameter
Size, without packaging (width × depth × height), unit: mm	620 x 640 x 1170mm, ±5%
Empty weight, without packaging	Approx. 180kg
Weight with packaging	Approx. 249kg

Dehydration cylinder	Parameter
Capacity	Up to 300 cassettes
Temperature (paraffin)	50°C - 65°C
Temperature (dehydration reagent)	Ambient temperature to 65°C
Temperature (rinse reagent)	60°C for alcohol; 65°C for xylene
Liquid level sensor	3 ultrasonic liquid level sensors
Concentration detection	1 concentration detection sensor
Cylinder lid lock	Automatic opening and closing of motor-driven lock
Cylinder lid heating	Ambient temperature to 70°C
Surface temperature of the cylinder lid	Lower than 45°C
Inner wall of the cylinder lid	Teflon plating

Paraffin cylinder	Parameter
Number of small paraffin cylinders	3
Number of large paraffin cylinders	1
Capacity of small paraffin cylinders	4.2L
Capacity of large paraffin cylinders	5.6L
Paraffin melting temperature	50°C - 75°C

Reagent bottle	Parameter
Reagent bottle	10
Condensate bottle	1
Rinse bottle	3
Reagent bottle capacity	Scale LEVEL1: 3L Scale LEVEL2: 4.3L Scale MAX: 4.8L

Management system (RMS)	Parameter
Reagent management parameters of dehydration program	Number of cassettes / cycles / days
Reagent management parameters of rinse program	Number of cycles / days
Active carbon management parameters	Number of cycles / days
Management parameters of seal rings for tissue processing cylinders	Number of cycles / days
Management parameters of seal rings for paraffin cylinders	Number of cycles / days
Management parameters of seal rings for reagent bottles	Number of cycles / days

User management	Parameter
Access level	Common user Administrator Manufacturer
Password type	Letter / Figure

Hardware and software	Parameter
Display screen	12.1-inch LCD color touch screen
Software	Dynamic display of operational processes and man-machine interactive system
Interface	Front panel: 2 USBs Rear panel: 1 USB, 1 network interface
UPS	With UPS power interface
Quality control function	Component quality control function

Overall function	Parameter
Preset program	small tissues, standard tissues and standard tissues overnight
Step time	0 ~ 23 hours 59 minutes
Delay time	Up to 7 days
Cassette	Up to 300
Rinse process	Fast rinse / standard rinse / warm rinse
Reagent bottle	10
Small paraffin cylinder	3
Large paraffin cylinder	1
Rinse bottle	3
Condensate bottle	1
Reagent temperature	Ambient temperature: -65°C
Paraffin temperature	50°C - 65°C
Rinse reagent temperature	Xylene for rinse: 65°C Alcohol for rinse: 60°C

3.4 Compatible Reagents



HP300 Plus can only use the reagent specified in this Section. Before dehydrating the sample tissue used for diagnosis, the laboratory must verify the reagents according to the local identification requirements.

The following reagents can be used in this equipment:

Reagent group	Reagent
Fixed group	Formalin (buffered or non-buffered) Formalin substitute
Dehydration group	Ethanol Isopropanol Methanol Butanol
Transparent group	Xylene Turpentine
Dip wax group	Paraffin
Cleaning group	Xylene Ethanol



Reagents other than those listed above may cause serious damage to the instrument assemblies.

DO NOT USE ACETONE, BENZENE, CHLOROFORM AND TRICHLOROETHANE.

4. First Installation

4.1 Installation Requirements

- The instrument requires a mounting area of approximately 850 × 800 mm.
- Device power supply: 100-120VAC,60Hz or 220-240VAC,50/60Hz.
- Considering the weight of the instrument, the ground must have sufficient load capacity and hardness.
- The instrument is for indoor use only.
- During installation, install the instrument where you can disconnect the main power very easy and quick.
- Do not connect using power strip.
- The instrument must be connected to a grounded power socket.
- Only use the cable provided for the local main power supply.
- Avoid vibration, direct sunlight and sudden temperature changes.
- The chemicals used in the HP300 Plus are flammable and harmful to health. Therefore, the installation site must be well ventilated and there must be no open flame.
- The installation site must have electrostatic discharge protection.
- Do not use the instrument in an indoor environment with explosive hazards.
- In order to ensure the normal operation of the instrument, it must be at least 10cm away from the wall and other device.



4.2 Unpacking and Installation

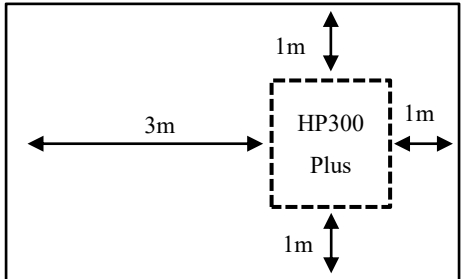

Before unpacking, check whether the fasteners of the packing container are complete and whether the appearance is damaged or deformed. If the above situation occurs, mark on the shipping documents accordingly and check whether the goods are damaged.

Instrument Unpacking

A. Unboxing location selected	
	<ol style="list-style-type: none">(1) Ensure there is enough space for the instrument to be unpacked. The side and back of the instrument are at least 1m away from the wall.(2) The distance between the front of the instrument is at least 3m, because HP300 Plus will be pushed down from the pallet in this direction. Move the instrument's packing container as close to the final installation site as possible.

<p>B. Move the packing box to the unpacking place</p>	<p>(1) Before unpacking, check whether the fasteners of the packing box are complete, whether the appearance is damaged or deformed, etc. If the above happens, please mark the shipping documents accordingly and check whether the goods are damaged.</p> <p>(2) Move the instrument packing box as close as possible to the final installation site.</p>
	<p>C. Remove the top cover</p> <p>(1) Remove the 6 fastening screws of the top cover with No. 14 metric or adjustable open-end wrench, and remove the cover and top foam by two persons.</p>
	<p>D. Remove the four-side protective plate</p> <p>1) Use metric No. 14 or an adjustable open-end wrench to remove the 14 fastening screws of the 4 front and left protective plates in turn, remove the 4 protective plates, and take out the bottom accessories;</p> <p>2) Remove the protective foam on the four sides, break the brake pads of the casters by hand, and release the casters.</p>
	<p>E. Top plate and base splicing</p> <p>1) Place the top plate upside down and join the</p>



wooden box base, and then drag out two guide rails from the bottom of the equipment to join the top plate;

- 2) Push the equipment off the pallet. When pushing the instrument down from the pallet, one person should hold the two outer corners with both hands to support the instrument; the other person should firmly hold the two handles on the back of the instrument, and slowly push the instrument from the pallet along the slope of the guide rail. under.
- 3) After placing it in place, remove all the foam from the machine.



At least two people are required to unpack and transport the instrument.

After disassembling the wooden strips fixing the casters of the tissue processor, release the brake of the casters of the dehydrator.

The equipment casters are very easy to move, and the empty weight of HP300 Plus is 180kg. When pushing the equipment off the pallet through the ramp, one person supports both sides of the marble countertop of the machine in front, and the other holds the moving handle behind, Slowly slide the machine from the base to the ground along the slope.



Check the received parts according to the attached packing list to confirm whether the delivery is complete! If any discrepancies are found, contact Dakewe or your local distributor immediately.

To prevent damage to the instrument or samples, only accessories and spare parts authorized by Dakewe can be used.

4.3 Host / Hardware

4.3.1 Installing the Monitor

1. The monitor (Figure 10-1) is a flip structure. During delivery, the rear cover of the strut member has been removed from the surface of the tissue processing cylinder.
2. Gently rotate the monitor back along the shaft and rest on the slope (Figure 10-2) of the marble cover plate.
3. Remove the monitor's strut member. The strut member is divided into three sections, namely upper segmental plate (Figure 10-3), intermediate segmental plate (Figure 10-4) and lower segmental plate (Figure 10-5).
4. The upper segmental plate is used to lock the monitor. There is a through hole in the middle of the segmental plate, corresponding to the mounting screw hole on the back of the monitor. Use hand screws (Figure 10-6) for locking.
5. Install the lower segmental plate in the mounting groove of the marble cover plate. Use 3 m4 screws (Figure 10-7) for locking.

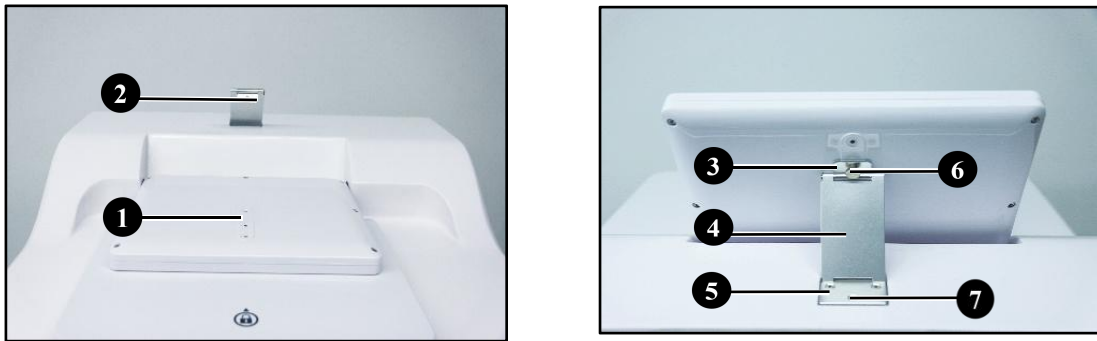

Figure 10

4.3.2 Color LCD touch screen

- HP300 Plus is operated by a color LCD touch screen, the size of the display is 12.1 inches;
- The angle of the HP300 Plus's touch screen can be adjusted through the support at the back, with a total of 3 adjustable gears;
- By default, if you don't tap the screen within 30 minutes, you will enter the screen saver. This time can be configured in the software settings. The screen display can be restored by touching any place. In order to prevent accidentally touching a certain button, the functions on the screen are unavailable within the first few seconds after the screen display is restored;
- The surface of the touch screen is affixed with a silica gel film, which can withstand the corrosion of all reagents. However, during use, you should still avoid any reagents splashing on the touch screen, if any, please wipe it immediately!



Figure 4.4.2 Color LCD touch screen

4.3.3 Dehydration Cylinder

Turn on or off the dehydration cylinder

- If power is not on, it is only allowed to rotate the manual opening knob for unlocking. The entire opening process takes about 3 minutes. Do not try to force open the dehydration cylinder lid.
- After the instrument powered on, click the “open lid” button on the display interface. The cylinder lid lock (Figure 11-1) will open automatically.
- Manually open the dehydration cylinder lid, you will see the Teflon plating inside the cylinder lid. If there is any residue, you can use the cleaning cloth attached to the machine for wiping and cleaning.
- After complete the tissue processing, manually flip the dehydration cylinder lid to closed and then click the “close lid” button. The electronic lock will automatically seal the dehydration cylinder lid.
- The on / off status of the dehydration cylinder will be displayed on the

monitor.

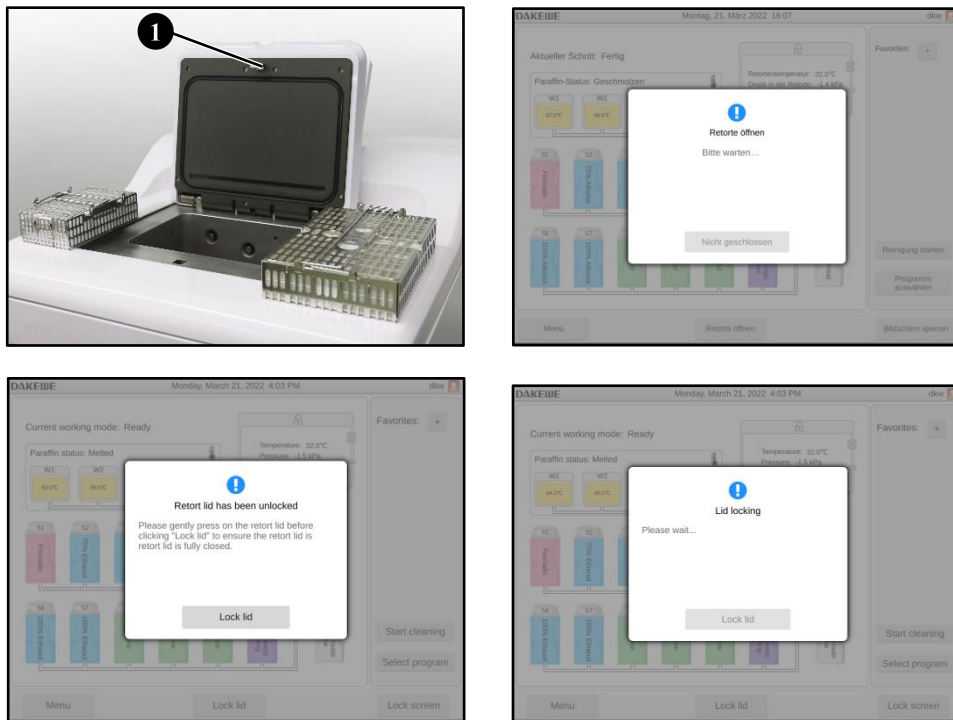

Figure 11



The tissue processing cylinder head is controlled by an electronic lock. When locking, do not put your fingers on the cylinder head area to prevent pinching. During the working process of the equipment, the temperature of the cylinder head is high, please be careful to prevent burns.

Liquid level sensor and dehydration cylinder strainer

- Liquid level sensor, concentration detection sensor, concentration detection sensor air filter, and retort filter.
- The retort is equipped with 3 ultrasonic level sensors and one concentration detection sensor: the first and second level sensors (Figure 12-1) are used to detect the height of the reagent level during dehydration, the third liquid level sensor (Figure 12-2) is used to monitor overflow risk. When the liquid level sensor 3 detects a liquid signal, the system automatically stops working to prevent the liquid from entering the gas system and causing a failure. The concentration detection sensor (Figure 12-3) is used to detect the concentration of reagents in the process of dehydration. An dust proof net is installed outside the concentration detection sensor (Figure 12-4) to prevent human error contact of the sensor probe and make it invalid.
- The bottom of the retort has a filter (Figure 12-5), which is locked by a custom-made bolt, there is a “-” spanner on the top of the bolt, turning the bolt counterclockwise with spanner to remove the filter.
- On HP300 Plus model, the retort is with grinding and polishing process, which can make the retort not easy to remain paraffin wax and other impurities, and easy to clean.



Figure 12

- Concentration monitoring
- When adding or replacing ethanol, set the initial reagent concentration value. During the operation of the equipment, the density meter will always monitor the concentration of ethanol, and the measured liquid concentration can be visually displayed on the screen to facilitate understanding of the reagent status; in addition, combined with the actual

concentration, which can effectively prevent reagent replacement errors.

- Click on any reagent bottle icon
- Click "Replace"
- Set the initial concentration value



Due to the high inner wall temperature of the dehydration cylinder, wear protective clothing, goggles, gas masks, rubber gloves, and all other necessary personal protective equipment. Keep a certain distance when opening the dehydration cylinder lid, especially after the reagent is heated. Always, avoid inhaling steam.

4.3.4 Active Carbon Filter

Insert / Replace the active carbon filter:

- After opening the service door at the front of the machine, you can see the air-tight door (Figure 13-1) with the active carbon filter parts on the right.
- Hold the handle on the front of the air-tight door and pull back to turn the air-tight door down, thus exposing the active carbon filter (Figure 13-2) inside.
- Hook the strap (Figure 13-3) on the front of the filter with fingers, and pull the active carbon filter out vertically;
- When inserting the active carbon filter for the first time, make sure that the direction of the arrow on the active carbon filter is the same as the one indicated by the arrow next to the air-tight door, with the end of the strap facing outwards. Then, push it in the direction of the vertical cover plate to the bottom. Close the air-tight door afterwards. Finally, close the service door.



The steam discharged from the instrument is harmful to human health. Before being discharged outside the machine, it must be filtered using an active carbon filter.

The active carbon filter is just an additional measure to reduce harmful vapor in the area around the instrument. In any case, the room in which the instrument is located must be ventilated. The frequency of filter replacement depends on the frequency of instrument use. However, the instrument shall be replaced at least every 45 to 60 days.

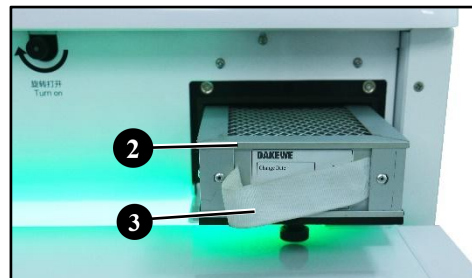

Figure 13

4.3.5 Exhaust Pipe (optional)

The instrument is designed to be connected to an external exhaust emission device. Put the attached exhaust pipe (Figure 14-1) on an exhaust vent. Use a pipe clamp (Figure 14-2) to fix the exhaust pipe to the exhaust vent. The outlet of the other end of the exhaust pipe is oriented outdoors or placed in a ventilation device.



Even if the instrument is connected to an exhaust emission device, the active carbon filter equipped for HP300 Plus must still be installed.

4.3.6 Marble Workbench

- An integrated marble workbench is mounted on the top of the HP300 Plus. The workbench has characteristics of small adhesion and easy cleaning. It can be wiped with a clean and lint-free cloth and, if necessary, any paraffin dropped on it can be cleaned with xylene reagent.
- The workbench area on the right side of the dehydration cylinder, can be used to place the prepared samples and the tissue sample baskets (Figure 15-1) removed from the dehydration cylinder.

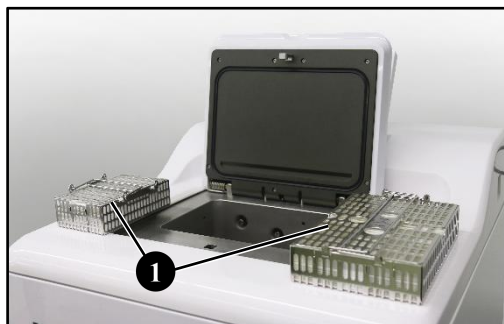

Figure 15

4.3.7 Tissue Sample Basket

- HP300 Plus is equipped with two stainless steel sample baskets (Figure 16-1). Each sample basket is equipped to hold up to 150 cassettes. Two baskets can be placed at a time and the maximum capacity is 300 standard cassettes.
- HP300 Plus can also be equipped with a small sample basket (Figure 16-2), each basket can hold up to 70 embedding cassettes, 4 baskets at a time, and the maximum capacity is 280. The sample basket has a handle (Figure 16-3), which is used to put the sample basket into the tissue processing tank or take it out of the tissue processing tank. The sample basket has a completely detachable lid (Figure 16-4), which is convenient for closing or removing the lid of the sample basket.

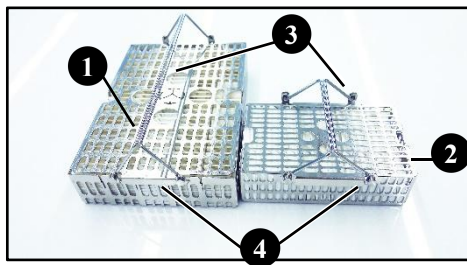

Figure 16



The sample baskets need to be cleaned prior to dehydration.

It is recommended to use the sample box type provided with the HP300 Plus.

4.3.8 Paraffin Cylinder

HP300 Plus is equipped with three small paraffin cylinders. The maximum paraffin storage volume of each paraffin cylinder is 4.2L. These three paraffin cylinders are used for routine dehydration process.

- HP300 Plus is also equipped with one large paraffin cylinder, with maximum paraffin storage volume of 5.6L. Large paraffin cylinders are generally used for paraffin filling and paraffin backup.
- The paraffin case door can be opened and flipped out for 90° , once opened, the box door becomes horizontal and can be used to support the extracted paraffin cylinder.
- All the paraffin cylinder handles (Figure 17-1) can be pulled out for paraffin filling. When reinserting the paraffin cylinder, align the connector (male) (Figure 17-2) of the paraffin cylinder with the corresponding connector (female) of the paraffin case. Gently force the paraffin cylinder in. When the male connector and female connector are connected, the sound of “click” will be heard. During this process, there is a slight resistance, indicating that the paraffin cylinder has been inserted in the right place.
- When the paraffin cylinder is withdrawn, it needs to be slow and steady, so as to avoid violent movement that causes paraffin to sway in the paraffin case

and splash.

- The paraffin cylinder must be filled with liquid paraffin by hand, or it can be filled with paraffin particles. The estimated time for melting the paraffin is approximately 12-18 hours, depending on the paraffin melting point used and the set paraffin melting temperature.
- The paraffin bath has the most two liquid level scale lines, which are the paraffin liquid level required to process the first and second baskets of samples. According to the number of samples to be processed, fill paraffin to the corresponding scale line.

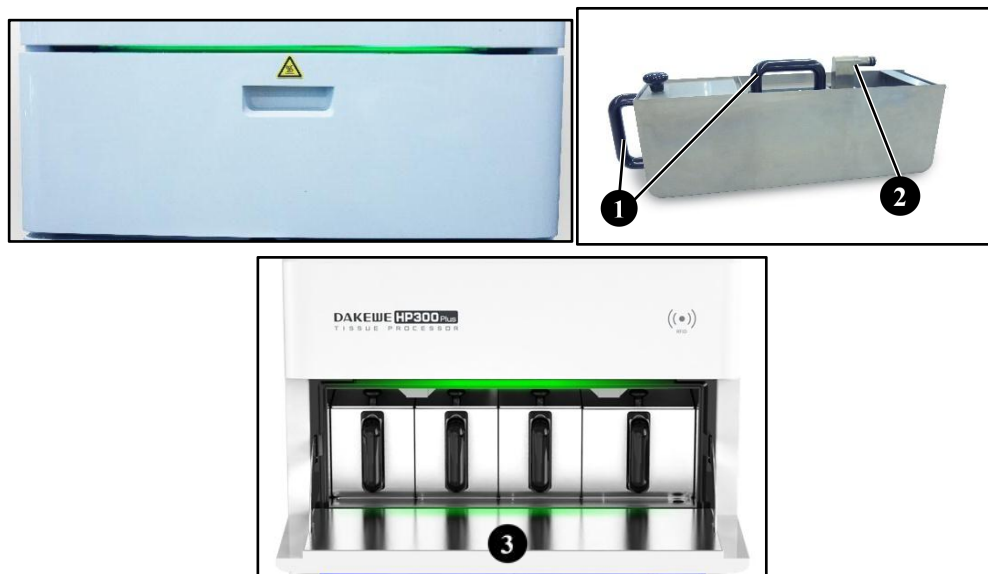

Figure 17



Pay attention to the paraffin case door hinge. Do not place your fingers in the position shown by the figure above (Figure 17-3).



Do not force the paraffin cylinder to be removed when the instrument is in a cold state. Such operation can cause damage to the instrument.



Pull out the paraffin cylinder slowly and carefully. Do not yank it. The internal liquid paraffin is very hot, and will cause burns. The surface, handle and lid of the paraffin cylinder are also very hot. Therefore, be sure to wear PPE clothing and operate with caution.

4.3.9 Waste Paraffin Collection Tray

- The waste paraffin collection tray (Figure 18-1) is located at the lower right of

the paraffin case and is used to collect spilled paraffin.

- The waste paraffin collection tray needs to be inspected and cleaned regularly. The waste paraffin collection tray can be removed from the mounting groove by the handle to clean the waste paraffin inside.



Figure 18

4.3.10 Reagent Compartment and Reagent Bottle

- HP300 Plus is equipped with 10 reagent bottles, 3 rinse bottles and 1 condensate bottle. These bottles are divided into two layers and placed in the reagent compartment below the paraffin case (Figure 20-1). Each reagent bottle is equipped with an RFID tag to identify and match the station and reagent bottle (Figure 21-4).
- The capacity of all bottles is 5L. There is a scale on the right front side of the bottle. Additionally, the bottles are marked with the scale of the first 3L, second 4.3L, third 4.8L liquid sensor located on the dehydration cylinder.

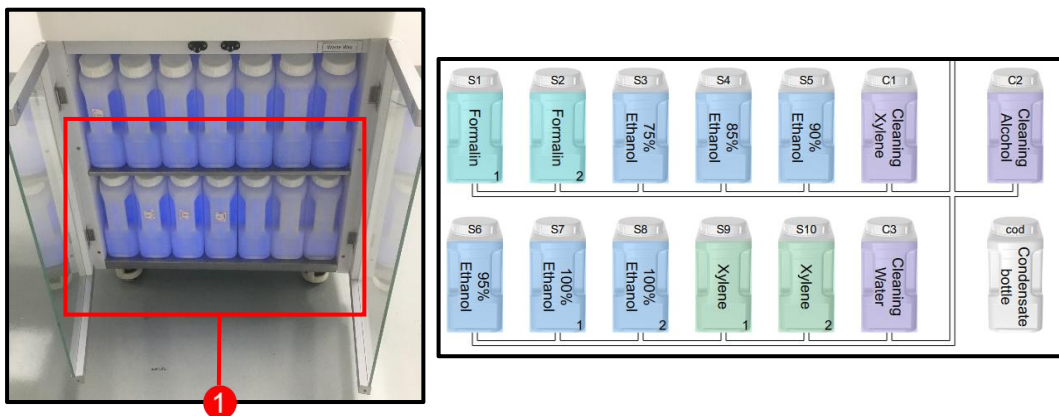

Figure 20

- Each reagent bottle has two inlets and outlets. The lower ones are the liquid inlet and outlet, and the upper ones are the gas inlet and outlet. The liquid inlet and outlet are equipped with two seal rings (Figure 21-3).



Figure 21

Pull out the reagent bottle

- Hold the reagent bottle's handle with the front end recessed (Figure 21-1). Pull the bottle out halfway. Grasp the horizontal handle (Figure 21-2) on the top of the bottle and use both hands to pull out firmly to remove the bottle from the reagent compartment.

Insert the reagent bottle

- Hold the horizontal handle at the top of the bottle with one hand, and hold the reagent bottle's handle with the front end and recessed with the other hand. Insert the bottle in the middle of the site marking in front of the reagent compartment. When you hear the shrapnel action sound of “click”, you can observe the blue light transmitted from the rear of the bottle. At this point, the software will show that the reagent bottle is in a colored state and installed in place.



Ensure that all reagent bottles are installed in place before the use of the device, after reagent replacement and after maintenance.



**Use only the reagent bottles that come with the HP300 Plus.
The connection interface of the reagent bottles needs to be pushed in place until you hear a click.**

4.3.11 Reagent Bottle Label

- The standard configurations of HP300 Plus include a set of sticky labels to adhere to the reagent bottles for identification of different reagents.
- Make sure that the surface of the reagent bottle is clean and dry prior to affix

the label. Compress and smooth it for proper placement.

- The reagent name, site number and commissioning date of the reagent specified in the color table can all be recorded on the label.

4.3.12 Reagent waste liquid collection module

- When the operator pulls out the reagent bottle to replace the reagent, the reagent is easy to overflow by shaking and thus remains on the reagent bin board. The reagents on the board will flow into the waste liquid collection plate through the diversion hole.

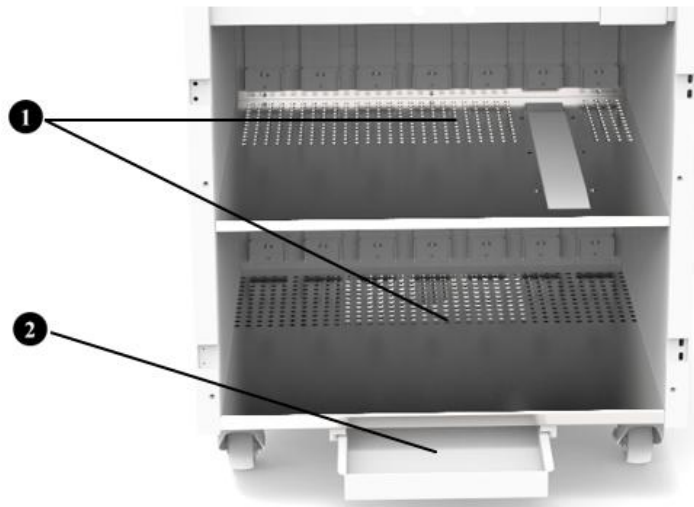

4.3.13 Reagent automatic liquid change

- The HP300 Plus is equipped with one filling pipe and one draining pipe. Combined with the automatic liquid change connector, the HP300 Plus can automatically change, fill and drain the liquid with one-touch away.

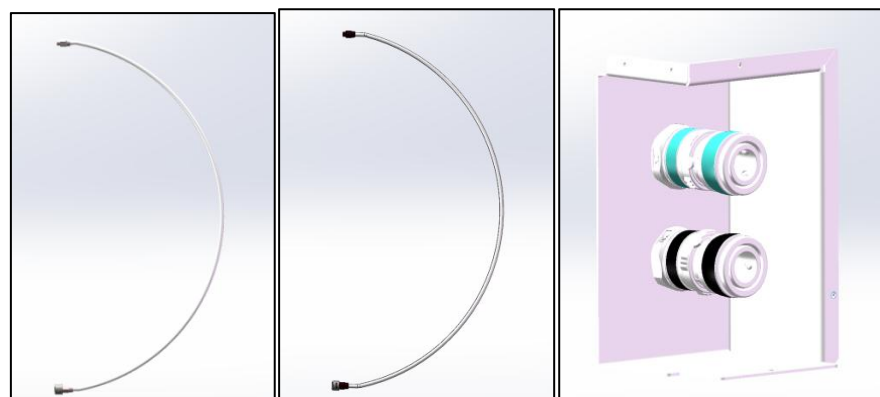

4.3.14 Cleaning xylene pre-heating

- When the ambient temperature is low, the compatibility between paraffin and xylene is low in the running state of the equipment, and there is a potential risk of pipe blockage when the xylene is not replaced in time. Therefore, it is particularly important to preheat and clean xylene in advance.

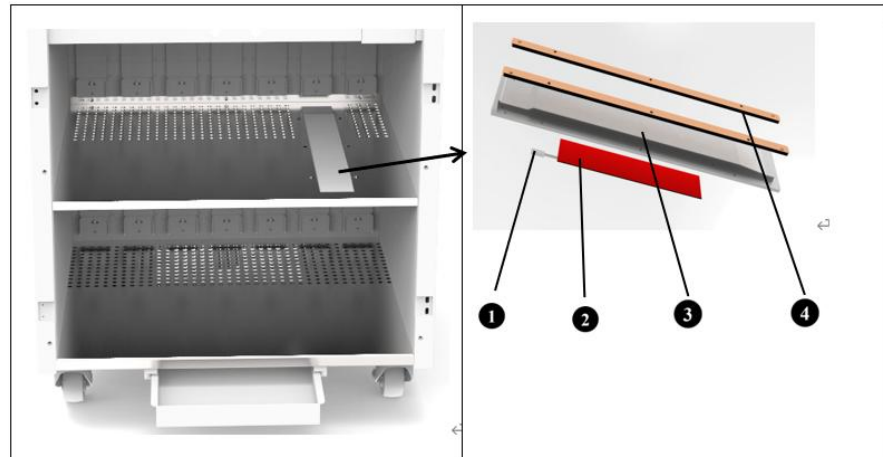

- 1. Temperature sensor: real-time detection of cleaning xylene reagent temperature
- 2. Heating plate: provide heat source, and overheat protection
- 3. Aluminum base: perfectly fits to the bottom of reagent bottle for maximum thermal conductivity
- 4. Heat insulation: prevent overheating loss of other reagents

4.4 Alarm Function



In the instrument, there will be some situations that require the user's attention or decision. The simplest case is some confirmation operations to continue the dehydration program. In addition, in the continuous monitoring of the hardware, there will be errors that must be eliminated as soon as possible in order to successfully complete the program operation. Accordingly, all messages will be classified according to their severity.

HP300 Plus has two different types of alarm functions:

Native alarm

This machine audible alarm is sent from the inside of the machine and is used for all alarm information during the operation of the machine.

Remote alarm

This alarm type is located outside the instrument. If the device is connected to a network (Figure 22-1), an alert message will be sent over the network to the responsible personnel.

The remote alarm can be received by electronic devices such as computers, IPADS or mobile

phones.

4.5 Main Power Supply and Power Jumper Connection



The instrument must use a grounded power socket.

The power plug must be in a convenient location for easy removal when necessary.

Use only the power cord that matches the local main power supply (output).

Do not use a power strip!

Check the nameplate on the back of the instrument to ensure that the delivered instrument matches the required voltage.

If the instrument is connected to a main power supply that is different from the voltage set by the factory, it may cause serious damage.

- Connect the main power cord (Figure 22-2) to the power socket.
- Use jumper wire connection (Figure 22-3) to connect the jumper input and jumper output of the electronic device.

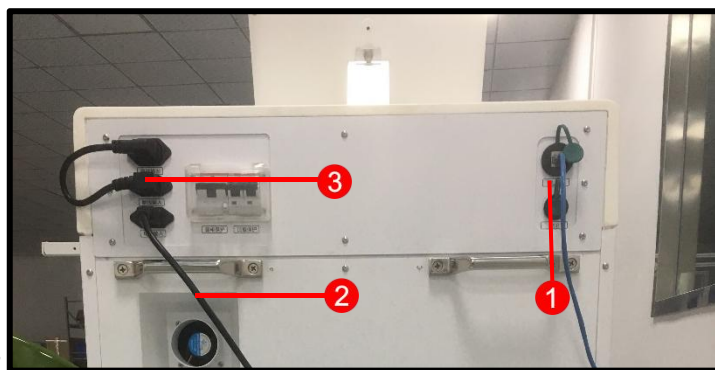

Figure 22

4.6 Instrument Startup and Login

1. Plug the power cord into a power socket.
2. Press the main power switch on the right side of the instrument.
3. It will take several minutes for the instrument to initialize after the instrument is turned on.
4. After the initialization is complete, the system will enter the boot preference setting interface (Figure 23). By setting preference settings, the use of the device is more in line with the actual user habits.

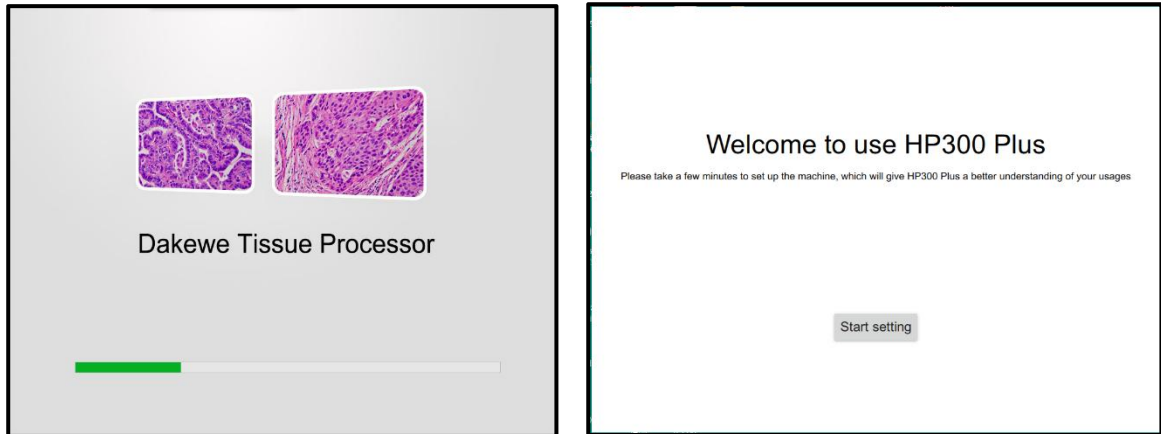
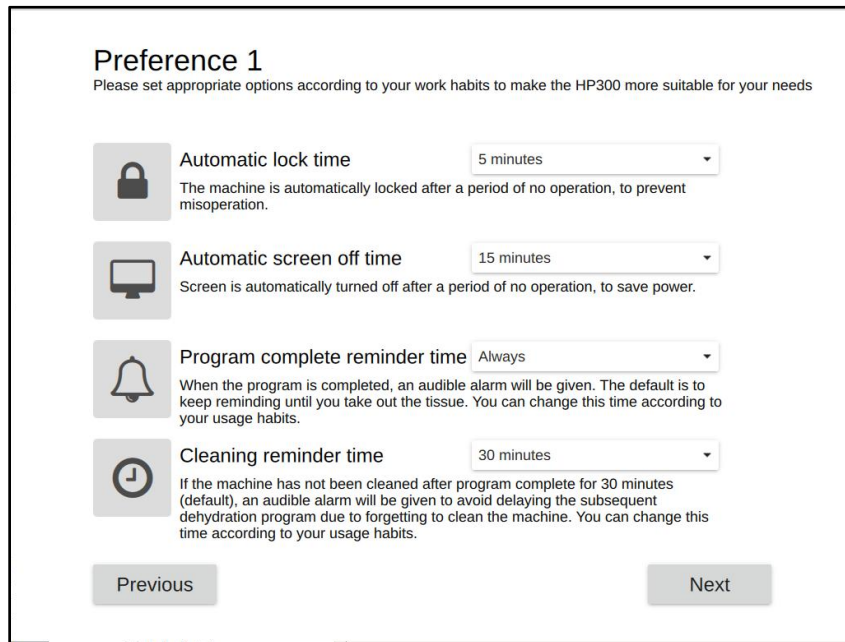

Figure 23

1. Boot preferences 1

After booting up, click "Start Setting" to enter the "Preferences 1" interface



Preferences 1

(1) Automatic lock time

The system will automatically enter the lock screen interface when there is no operation after the set time;

(2) Automatic screen rest time

The system will automatically enter the power-saving mode after the set time without operation;

(3) Reminder time for disembarkation

After the program is completed, there will be a sound to remind the user to get the organization, and the duration of the sound is set here (the default is "forever", always reminding);

(4) Cleaning reminder time

After the dehydration process is completed, manually click the drain to start the

timing. In order to prevent forgetting to clean, there will be a cleaning machine reminder. The default is from the start of the timing to 30 minutes when there is no cleaning, there will be a sound prompt, and the main interface will prompt Need to run a cleaning program.

2. Boot preferences 2

After finishing the preference setting page 1, click "Next" to enter the "Preferences 2" interface to set. To go back to the previous setting page, click "Previous".

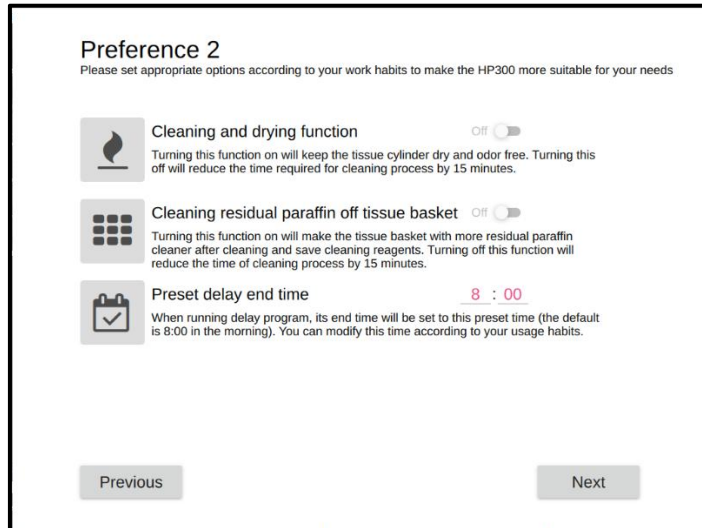

Preferences 2

(1) Choose whether to turn it on according to the actual use. The washing and drying function is turned on by default. Turning on this function will keep the tissue cylinder dry and odorless. Turning off this function will reduce the cleaning procedure time by 15 minutes;

(2) Function of melting residual wax in tissue basket Before running the first step of the standard cleaning procedure, pump paraffin from W1 to soak in the tissue processing tank to melt the residual wax attached to the tissue basket and return it to W1, which reduces the consumption of paraffin and the loss of cleaning reagents. The melting is turned off by default. Tissue basket residual wax function;

(3) Preset delay end time When you select a delay in the running program, the end time will be set to this preset time (the default is 8 am), and you can modify this time according to your habits.

3. Administrator account creation

You need to create an administrator account for the first login:

- (1) Click to select the input field of "Please enter user name", and a soft keyboard will pop up;
- (2) Enter the user name, click "  " to exit the soft keyboard after confirmation;
- (3) Select the "set password, confirm password" input field in turn to pop up the soft keyboard, enter the set password. The password should be 1-20 digits;
- (4) Click the "Next" button to complete the creation of an administrator account.



(a) Enter your user name

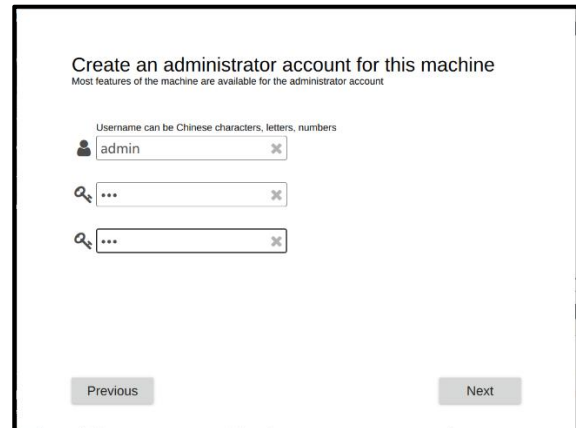

(b) Successfully created admin user

After completing the above settings, the interface displays "Setup successful", that is, the common related configuration for the first use is completed. Click "Start to use" to start using the device.

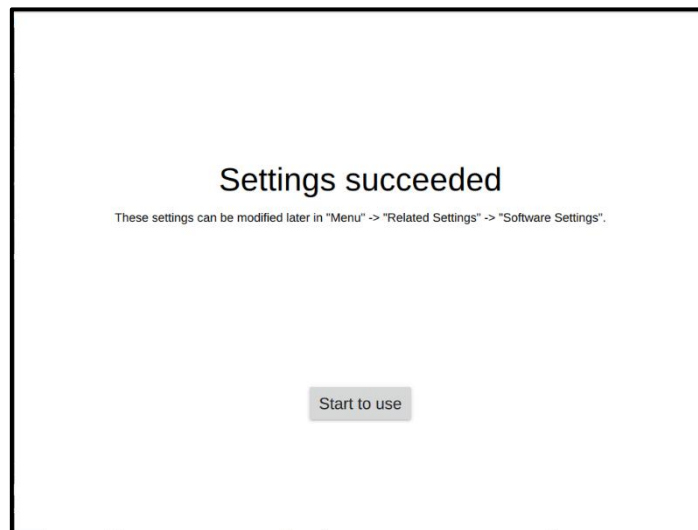

Setup success page

4.7 Touch Screen Functions

4.7.1 Screen lock

The system defaults that the device does not receive any operation within 10

minutes and will enter the lock screen state. Click "Unlock Screen" to enter the login interface, and re-enter the password to return to the software operation interface.

4.7.2 Screen Protection

If the system does not receive any operation within 15min by default, a screen saver will close the screen display. Touch the screen at any point to restore the screen display, then click "Unlock" to enter the login screen. Re-enter the password to restore the interface.

4.8 Turn off the instrument

To completely shut down the instrument, you need to perform the following steps:

(1) In the main interface, click the "Menu-Settings-Software Settings" button in turn to enter the "Software Settings" module

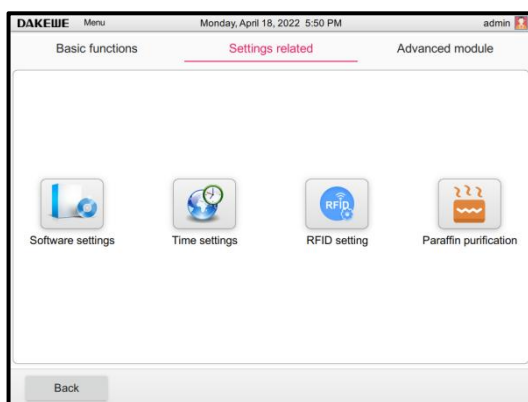

(a) Menu-setting related

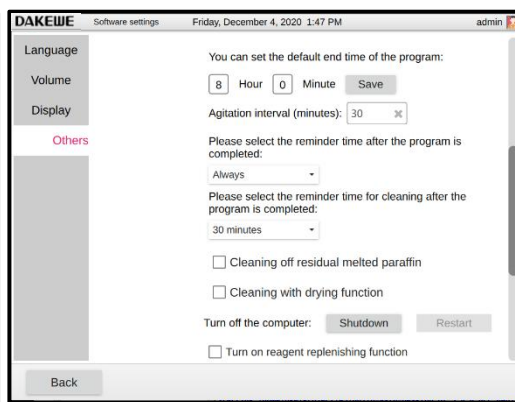

(b) Software settings

(2) In the software settings-other settings interface, click the "Shutdown" button, the system will pop up a shutdown confirmation message box.

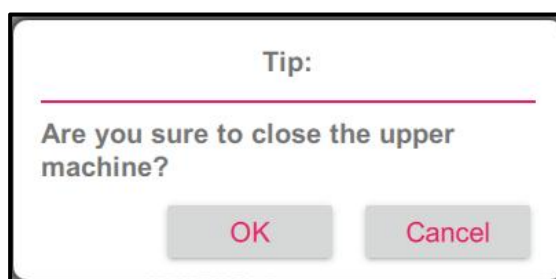

(3) Click "OK" to shut down the system. After the display is completely off, use the main power switch on the right side of the instrument to turn off the instrument.



Do not turn off the instrument while the program is running. Please follow the steps provided above to completely shut down HP300 Plus, shutting down the device in other ways may cause serious damage to the instrument hardware and result in data loss.

4.9 Instrument handling

Follow the steps below for instrument handling:

- (1) Release the brake of the instrument's casters;
- (2) Hold the handle on the rear panel with both hands and push the instrument to a new position. The pushing process cannot be too fast;
- (3) When the instrument reaches the new position, lock the caster brakes.



Be sure to turn off the instrument before moving the device.

Before moving the instrument, the power cord must be disconnected from the main power supply and wait for the instrument to cool down.

Before moving the instrument, make sure that there is no paraffin in the wax bath or waste wax collection tray, and the wax boxes and activated carbon doors are closed to prevent the wax bath from falling out during the movement. Or remove the wax bath from the device.

During the movement process, the cylinder head is locked.

To avoid spilling or falling of reagent bottles due to shaking of reagents in the reagent bottles during the movement of the equipment, all reagent bottles must be emptied or taken out before moving.

During the moving process, ensure that the reagent compartment door is closed, and at the same time use tape to fix the door to avoid opening the door during the moving process.

5. Instructions before use

5.1 Access Level

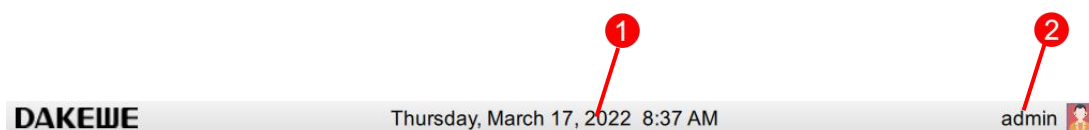

Figure 26

5.1.1 Device Status Indication

The following information is displayed on the status bar:

1. Current date (Figure 26-1). For current date setting, refer to 5.3.2.1.
2. Active user name and symbol (Figure 26-2). There are three user levels, namely common user (default level), administrator user and manufacturer user. For user level switching, refer to 5.1 "Access Level".
3. The currently logged-in user name and its own authority icon, there are three authority levels, ordinary user, administrator user, factory user. To switch the user level, please refer to Chapter 5, Section 2 "Access Level".
4. Prompt message area: The system will display the device status information in the user's operation process in a pop-up window in the central area at the top of the screen. It will automatically disappear after a few seconds.

5.1.2 Main Interface

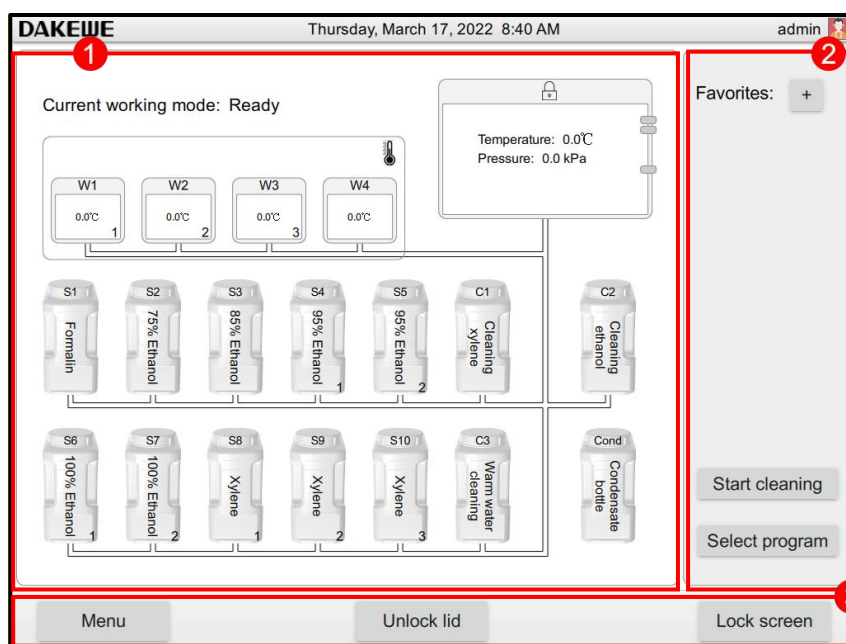

Figure 27

The main interface includes three parts:

1. Work panel (Figure 27-1): The work panel is the main interface of the main window, showing the layout of HP300 Plus, filling of the reagent bottle and paraffin cylinder, filling of the dehydration cylinder, temperature of the paraffin cylinder and dehydration cylinder, pressure of the dehydration cylinder, and step details of the dehydration process.
2. Operation status panel (Figure 27-2): The operation status panel displays the quick start button set by the machine before the dehydration process starts. Each button represents a different dehydration process. Click any button to quickly start the set dehydration process. During the operation of the dehydration process, the operation status panel shows the progress of dehydration, including the expected end time, current step, remaining time of the current step, etc.
3. Tab panel (Figure 27-3): There are three buttons on the tab panel. Click the menu button to enter the main menu interface. All configuration items of the system are operated under the main menu interface. The lid open button controls the opening and closing of the dehydration cylinder lid. The lock button can lock the touch feedback of the function button in the work area to prevent misoperation.



After the keyboard is locked, click the “Unlock” button to enter the password again before entering the operation interface.

5.1.3 Soft Keyboard





HP300 Plus can be used with an external mouse and keyboard. You can also touch the soft keyboard that comes with the system to input the information.

- The keyboard will be displayed every time you need to enter the text.
- The keyboard spacebar indicates the type of text entered: English keyboard (Figure 28).

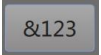

Figure 28

Important Keys

Key	Description
	Chinese-English shift
	Delete the previous character
	OK
	Shift letters / figures and special characters
	Shift uppercase / lowercase
	Exit soft keyboard

5.2 Access Level

HP300 Plus has three levels of access. The user level symbol is shown in the upper right corner of the display. For access login, refer to 4.7 *Instrument Startup and Login*.

1. Common user: Common user is the default user level after logging in to the instrument. Common user is able to use conventional processor functions, such as running programs, viewing results, setting the reagent status to null or full, etc. Functions that cannot be accessed by the common user will pop up a warning message at the top center of the screen (Figure 31).

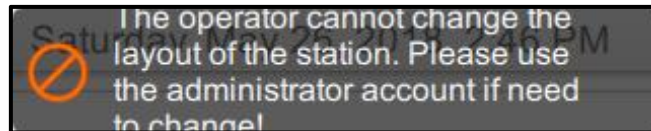



Figure 31

2. Administrator: The administrator is able to perform all functions of the common user. In addition, the administrator is also able to create and modify the program, to perform initial setup functions, etc.
3. Manufacturer user: For use by the technical service personnel of the manufacturer only.

5.3 Account login

The user needs to log in with the account and password to run the program. The login method is as follows:

Click the input field behind the user icon to pop up the user list, and select the account to log in from the list; Click the input field behind the password icon to pop up the soft keyboard, and then click " ← " or "  " to close the soft keyboard after entering the password; Click the login button to log in.

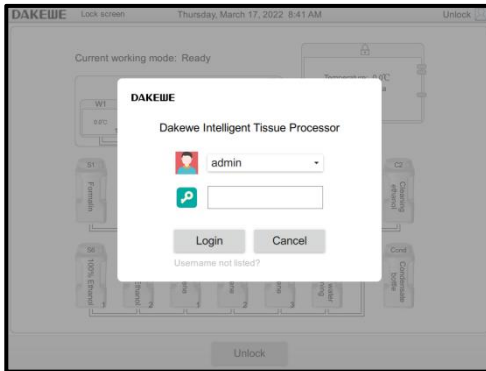

(a) Show user list

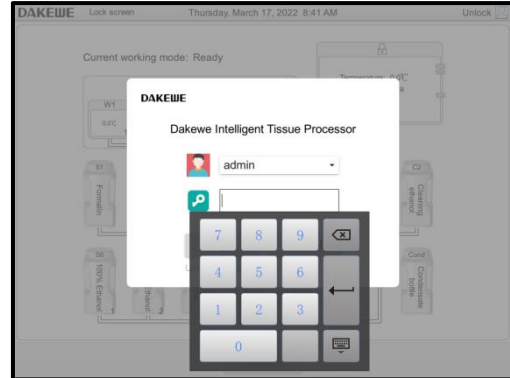

(b) Enter password to log in



In the menu → Basic Functions → User Management, create the user's account. After the creation is successful, you can find the created account name on the login page.

5.4 User Interface



Only the control elements that are actually accessible to the user are displayed on the screen.

The settings that can be accessed and set depending on the user's permission level are also different.

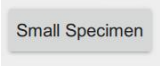
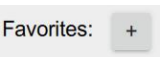
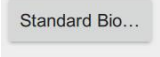
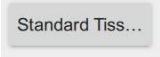
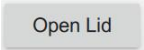
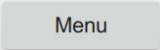
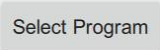
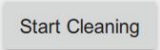
User interface icon button

	Shortcut icon: Click the icon, so that the processor can perform the dehydration operation according to the dehydration program configured by this button.		Program shortcut key setting icon: Click “+” to enter the shortcut program setting interface, so that the program in the list can be assigned to the shortcut button.
			
			
	The processor lid can be opened after clicking the “Open Lid” button.		System menu icon: Click to enter the next menu.
	Program running icon: Click to enter the program list interface. You can select any program for execution.		Rinse program running icon: Click to enter the rinse program list interface. You can select any rinse program for execution.

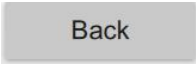
Generic icon button

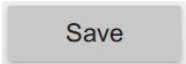
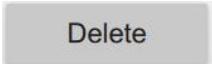
	Click to return to the previous menu or exit the current interface.		Select a list and click the “View” button to view the information.
	Click to save current settings and exit.		Select a list and click the “Delete” button for deletion.

6.Menu module

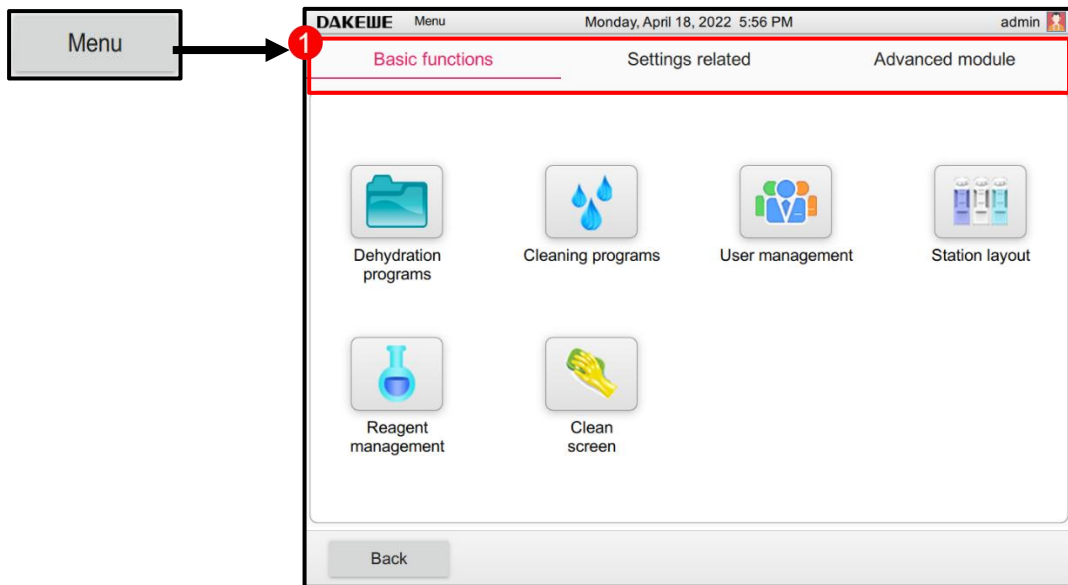

Figure 32

Click “Menu” button to enter the menu interface. The interface provides three submenus (Figure 32.1). Touch the central area of any submenu to display the next submenu button that can be manipulated

6.1 Basic Function

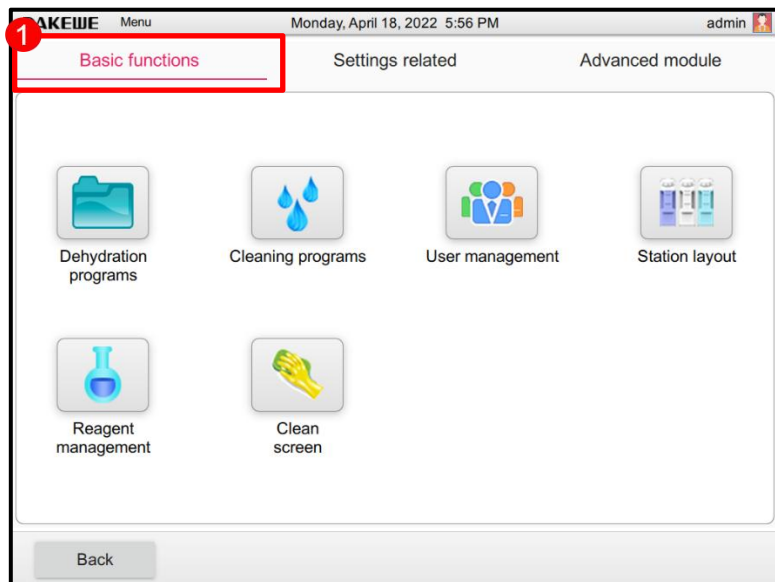

Figure 33

Click “Basic Function” button to enter the basic function interface (Figure 33-1). You can select the dehydration program, rinse program, user management, site layout, reagent management and screen cleaning on the interface.

6.1.1 Dehydration Program

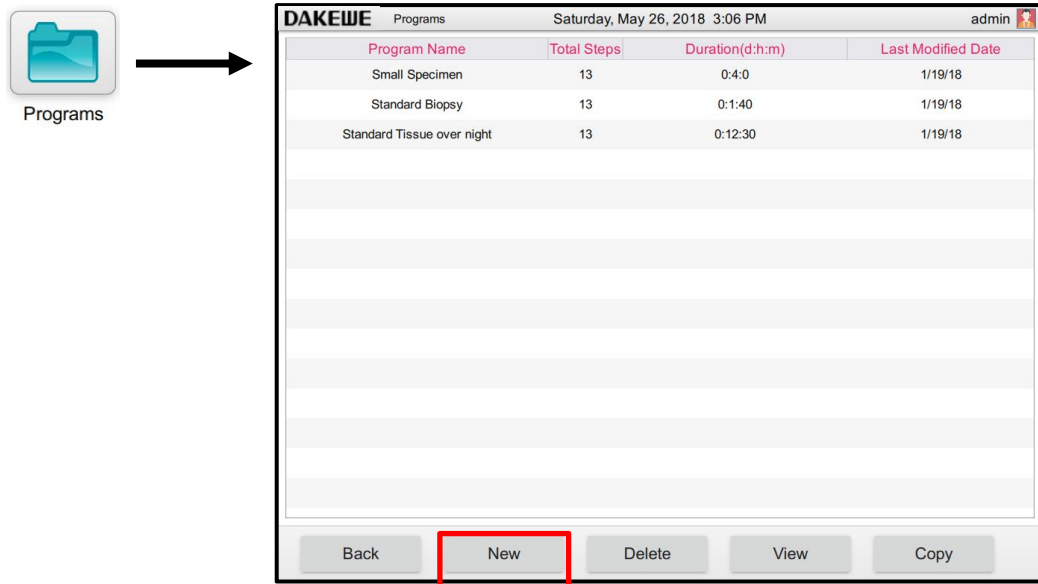

Figure 34

Click “Dehydration Program” button to enter the user program interface. It is able to perform the operations such as program creation / viewing / deletion / copying in this interface (Figure 34).



Only administrator user and manufacturer user can create / view / edit / delete / copy the program. During operation, it is necessary to ensure that the machine has no running programs

6.1.1.1 Create the program

Click “Create” button (*Figure 34-1*). The system will automatically create an unnamed blank program form (*Figure 35*).

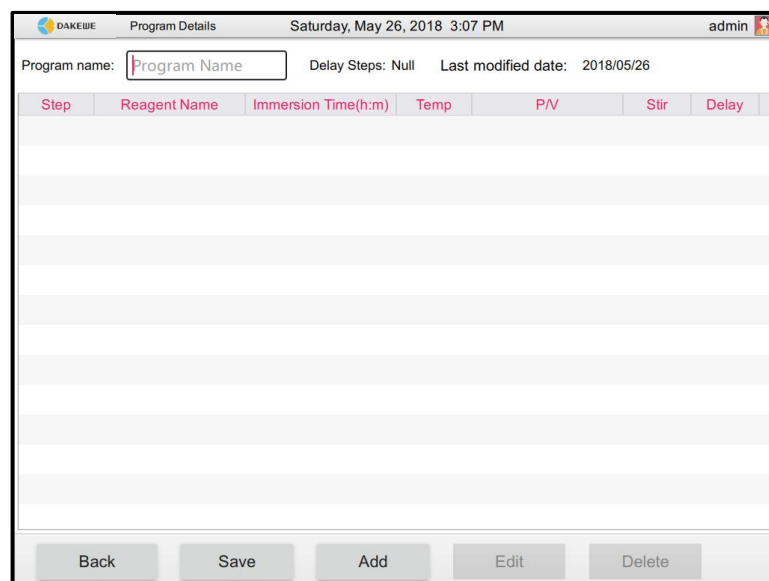
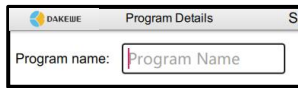

Figure 35

Enter the program name



Click the “Program Name” column. A soft keyboard pops up to name the new program: Multiple characters can be entered (can include Chinese, English and figures, up to 24 characters).

Add a program step



Click “Add Step” to edit the dialog window. The window lists the items that must be set in the step line.

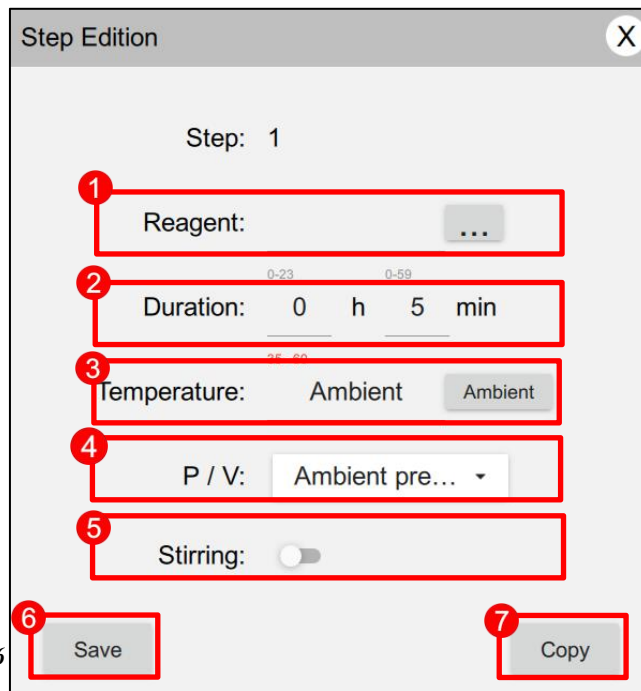

Figure 36

- Figure 36-1: Click the button on the right side of the “Reagent” option box. The default reagent list of the system pops up. Touch to select the desired reagent.
- Figure 36-2: Touch the pop-up soft keyboard to set the time required for the reagents to soak in each step.
- Figure 36-3: Touch the pop-up soft keyboard to set the desired temperature for each step.
- Figure 36-4: Click the triangle on the right side of the “P/V” item bar to pop up a drop-down box. The default pressure setting list of the system pops up. Touch to select it.
- Figure 36-5: Set whether stirring is required in the program step. If stirring is not activated, it will be in gray state. If stirring is activated, it will be in red state.
- Figure 36-6: Click the “Save” button to complete the creation of the step line and return to the creation interface.
- Figure 36-7: Click “Copy A Line”, and the system will automatically save this step line and quickly copy a new line, allowing users to quickly create step lines.

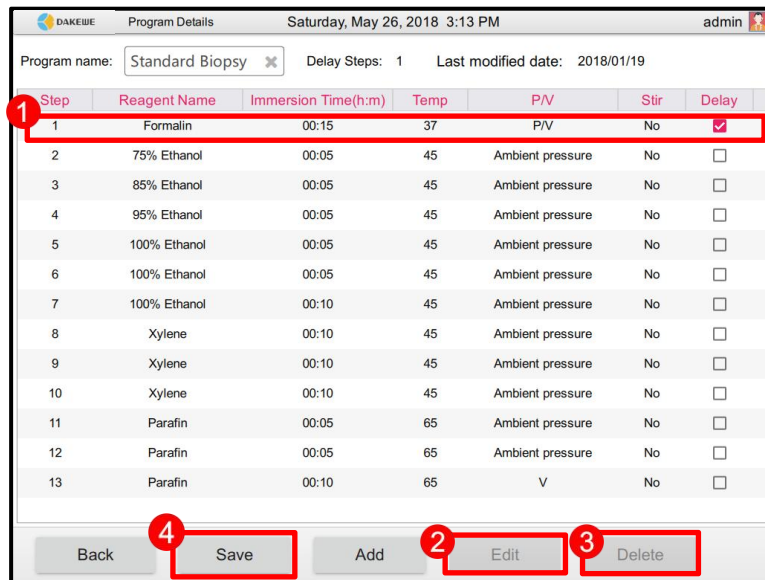

Figure 37

- Figure 37-1 delay start: After all step lines are created, it is necessary to specify one step for the program to delay start. Click the box on the right side of the step line to check.
- Figure 37-2 re-editing step: Touch to select the step line to be modified. Click the “Edit Step” button to enter the editing interface of this step line.
- Figure 37-3 delete step: Touch to select the step line to be deleted. Click the “Delete Step” button. The system will directly delete the selected step line.

Check that all program steps are set correctly. Click the “Save” button (*Figure 37-4*) to save the newly created program and exit automatically. Return to the dehydration program list interface.



Each program must and only allows to set one procedure as delay start. Under this condition, the program will prolong this procedure processing time.

6.1.1.2 Delete the program

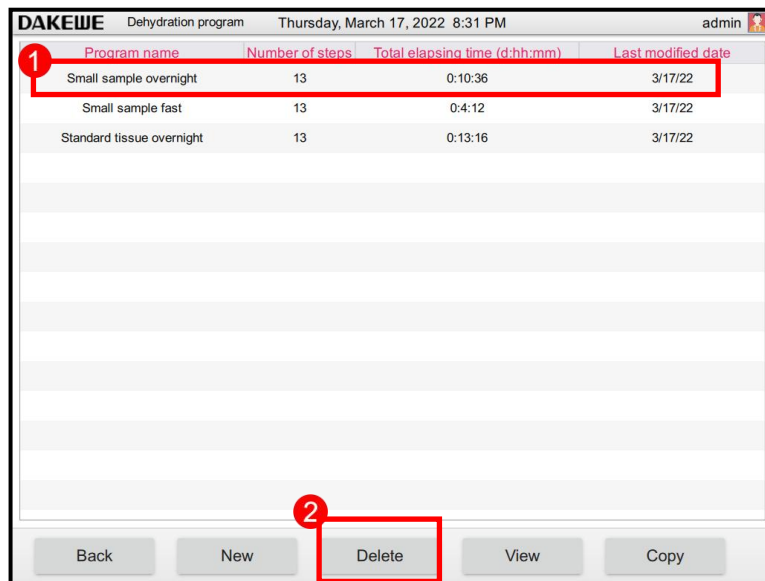

Touch to select the program to be deleted (Figure 38-1); Click the “Delete” (Figure 38-2) button to pop up the deletion dialog box; Click “OK” (Figure 38-3) to confirm deletion. Click “Cancel” to cancel the delete operation.

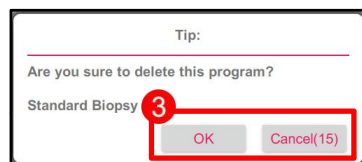

Figure 38

6.1.1.3 View / modify the program

In the program management interface, touch to select any program in the program list (Figure 39-1). Click the “View” button (Figure 39-2) to enter the program details interface.

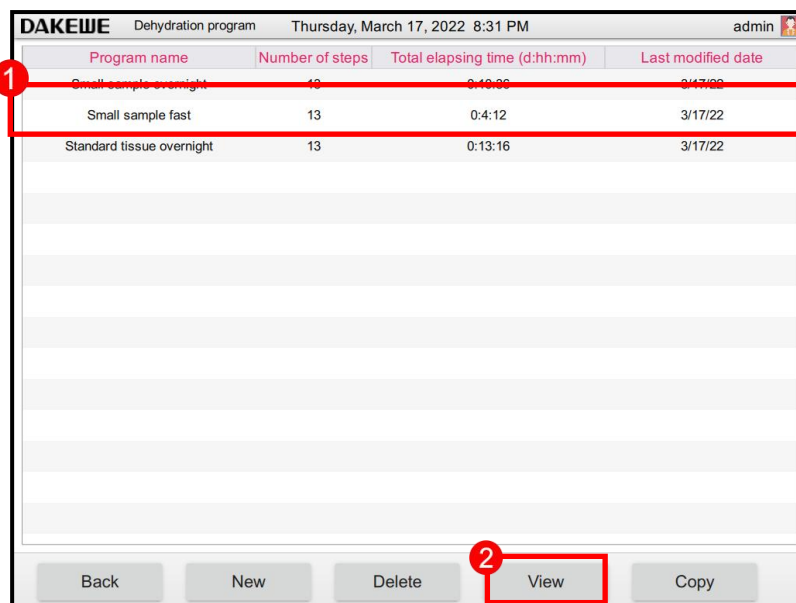

Figure 39

6.1.1.4 Copy the program

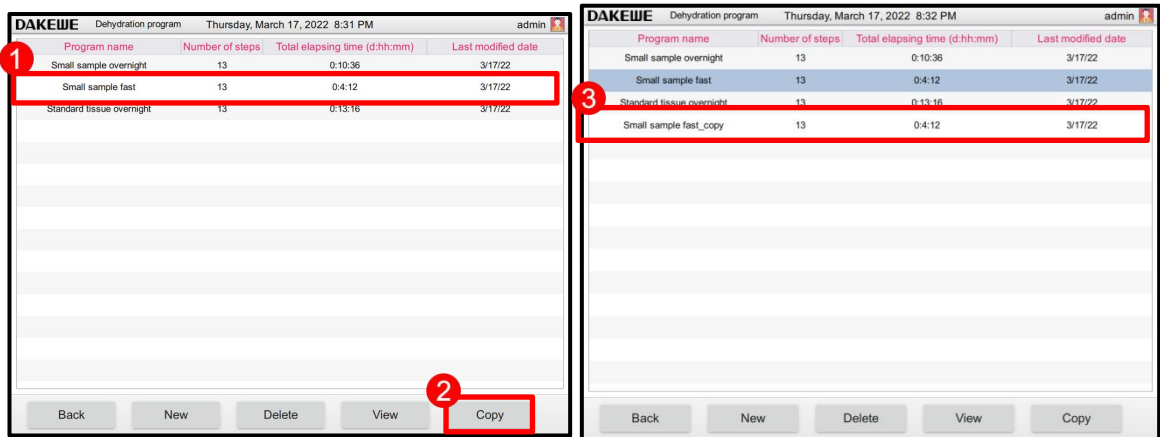

Figure 40

Touch to select the original program (Figure 40-1) to be copied;
 Click the “Copy” button (Figure 40-2). The system automatically creates a copy program named “original program name_copy” (Figure 40-3).



When the program is running, the current program is not allowed to be modified, other programs can be modified.

6.1.2 Rinse Program



Cleaning Programs

Click “Rinse Program” in the basic function interface to enter the rinse program interface. This interface allows you to view the default rinse program in the processor. This interface only prompts the viewing of the pre-installed program (Figure 41-1). It is not allowed to perform editing changes on the pre-installed program.

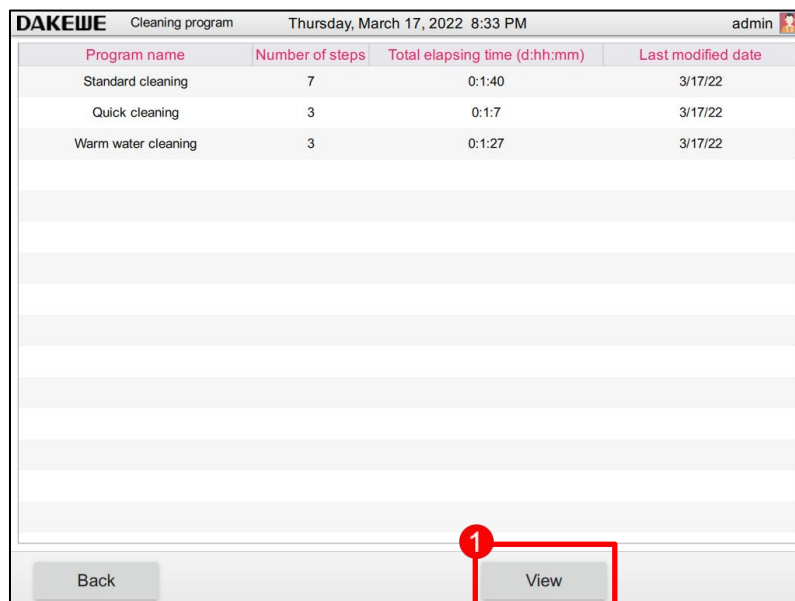

Figure 41

6.1.3 User Management



Users

Click the “User Management” button in the device management interface to enter the user management interface (*Figure 42*). You can add / delete users or modify the password in this interface.

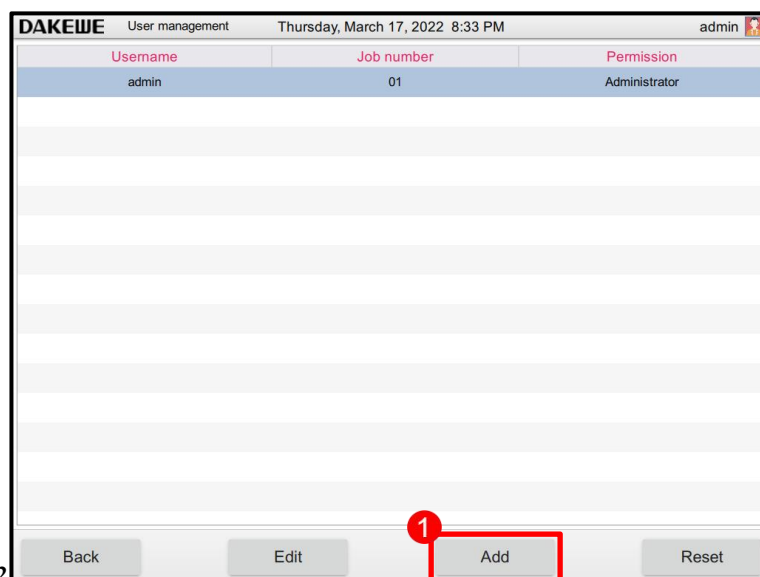

Figure 42

6.1.3.1 User permission

Common user: General functions of the processor, such as running programs, viewing results, setting the reagent status to empty or full, etc., are available to common users. The functions that are unavailable to the common users will not be displayed in the function menu.

Administrator: Administrators can perform all common user functions. In addition, they can create and modify programs, perform initial setting functions and shutdown.



Users with administrator authority can add/edit/delete users, and users with operator authority can only edit this account and reset the password.

6.1.3.2 Add user

Click “Add User” (Figure 43-1). The “Add User” edit entry displays on the right. Touch the user name, work code and password columns successively. Enter characters (Composed of Chinese, letters or numbers) after the soft keyboard pops up (Figure 43-2). Set permissions afterwards. Click the “OK” button to complete the addition of new users. The added users will be displayed on the left.

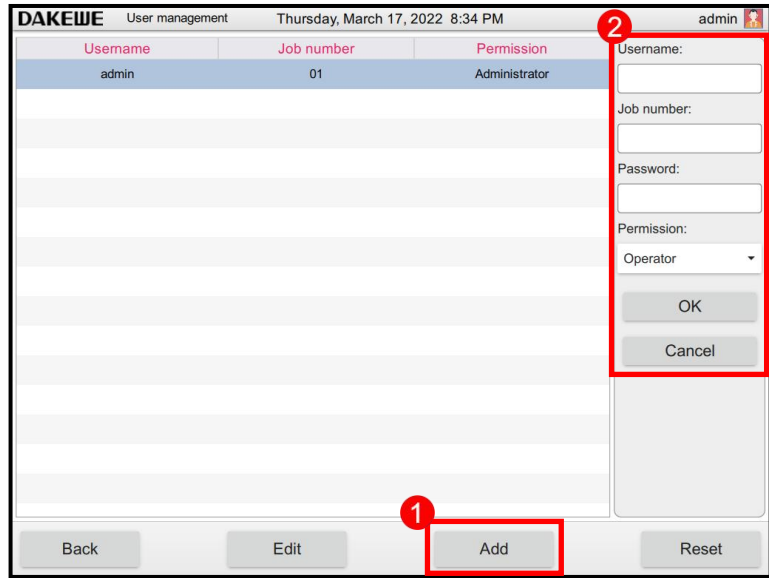

Figure 43

6.1.3.3 Edit user

Touch to select any non-administrator account. Click “Edit User” (Figure 44-1). Users can re-edit user names and work codes (Figure 44-2). Click OK button for saving after the change is complete. Click Cancel to stop modifying the user operations.

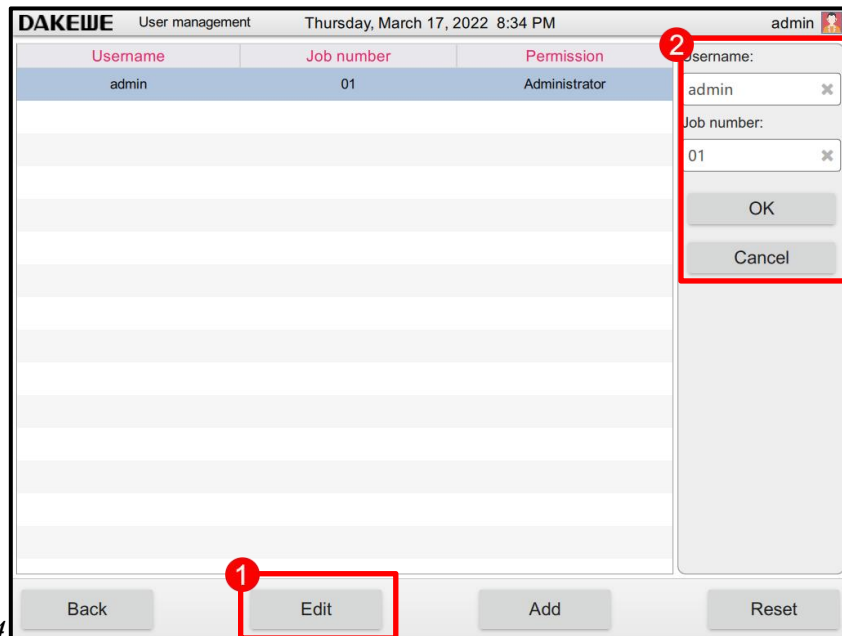

Figure 44

6.1.3.4 Reset password

Touch to select any account. Click “Reset Password” (Figure 45-1). Then, the user can modify the account password (Figure 45-2). Click OK button for saving after the change is complete. Click Cancel to stop modifying the user password.

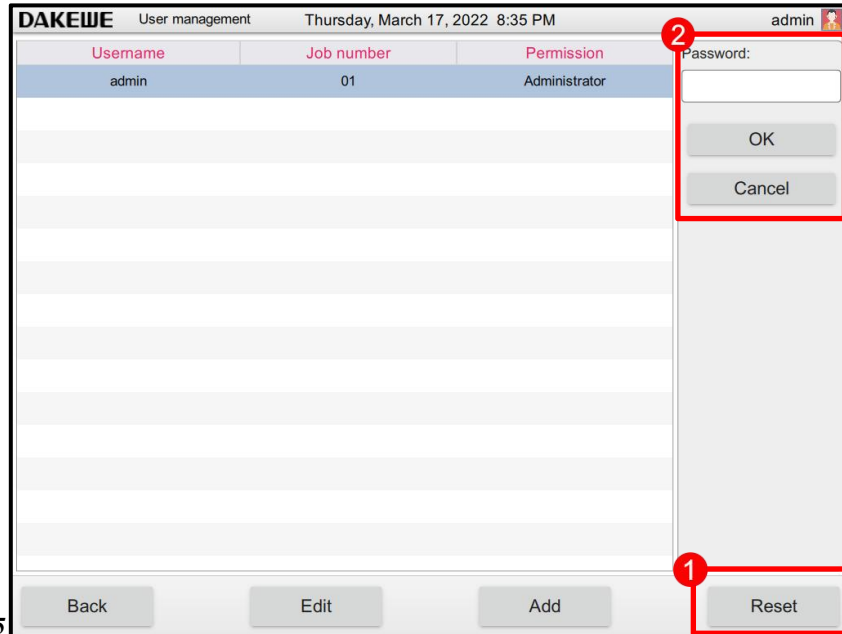

Figure 45

6.1.3.5 Delete users

When the administrator account selects other user accounts, At this time, the "Delete User" button appears, click "Delete User", the "Delete User" dialog box pops up, click "OK" to confirm the deletion, "Cancel" cancels the delete operation.

6.1.4 Site Layout



Stations

Click “Site Layout” in the basic function interface to enter the site interface (Figure 46). You can modify each site in this interface.

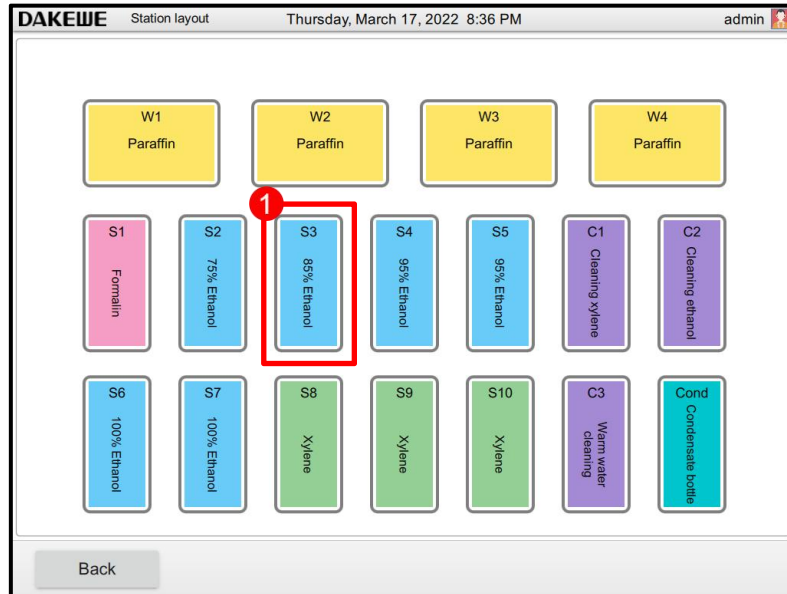

Figure 46

6.1.4.1 Change site reagents

Touch any site (Figure 46-1). The reagent selection list window pops up (Figure 47-1). Touch to select the reagent name to be replaced in the list to complete the reagent modification of the reagent site.

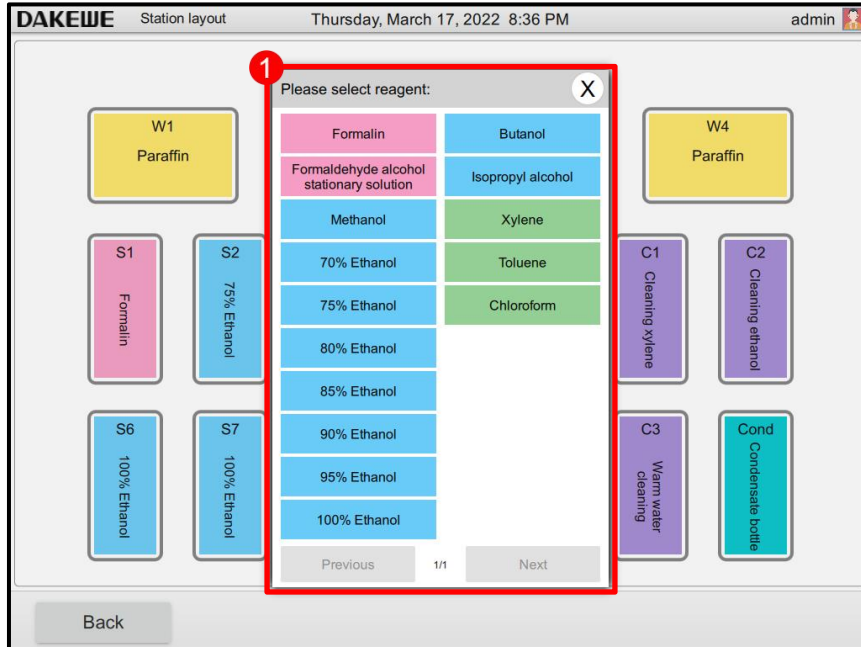

Figure 47



It is not allowed to modify the site reagents in some sites, such as paraffin site, rinse site and condensate bottle site. When the operation is attempted, the system pops up a warning message.

6.1.5 Reagent Management



Reagents

Click the “Reagent Management” icon to enter the reagent management interface. It is allowed to add and delete the reagents in this interface.

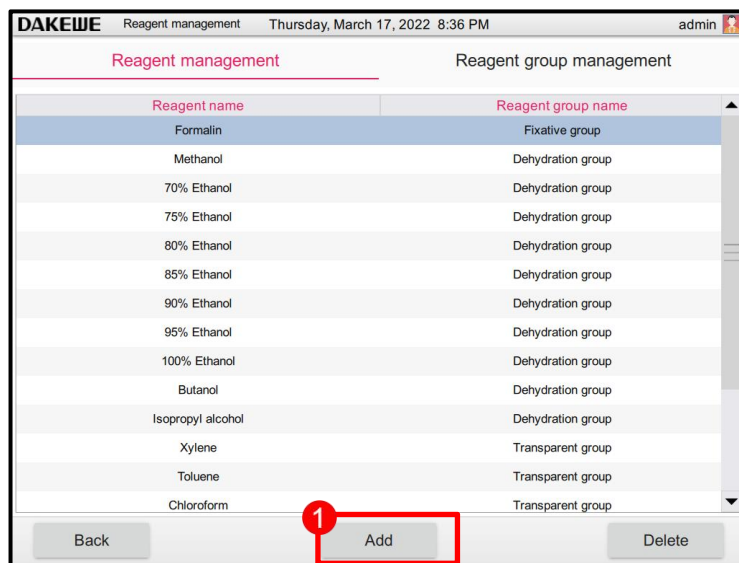

Figure 48

6.1.5.1 Add reagent

Click the “Add Reagent” button (Figure 48-1). The new reagent setting (Figure 49-1) will display on the right. Touch the reagent name to pop up the soft keyboard input box. Enter the corresponding reagent name. Then, select the appropriate reagent group name in the drop-down list of the reagent group. Click Save when it is done.

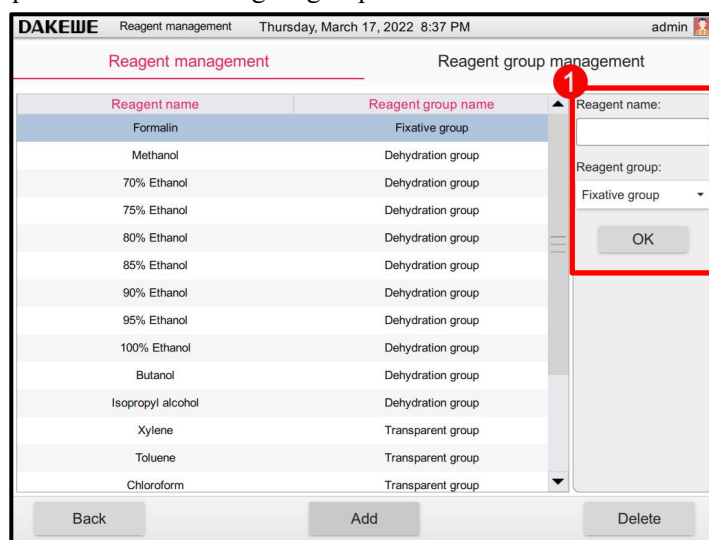

Figure 49

6.1.5.2 Delete reagent

Touch to select any reagent. Click the “Delete Reagent” button (Figure 50-1). The system will pop up the delete prompt box (Figure 50-2). Click the OK button to delete the selected reagent. Click Cancel to stop deleting the reagent.

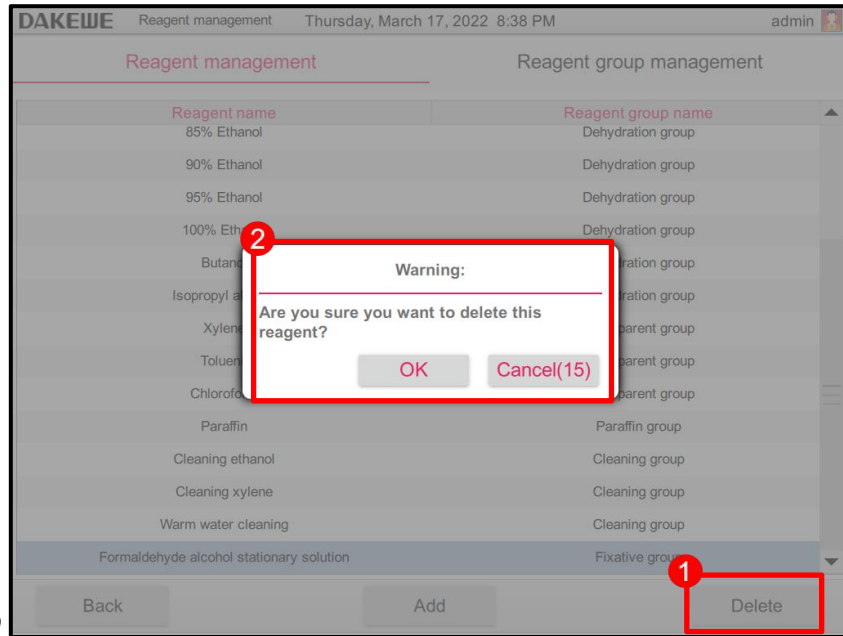

Figure 50

6.1.6 Screen Cleaning



Clean TouchScreen

Click the "Clean Screen" button to enter the cleaning screen interface, which provides the function of avoiding touching the software function buttons by mistake during screen cleaning. To exit, press and hold the back button until the red progress bar turns a full circle to exit the cleaning screen interface.

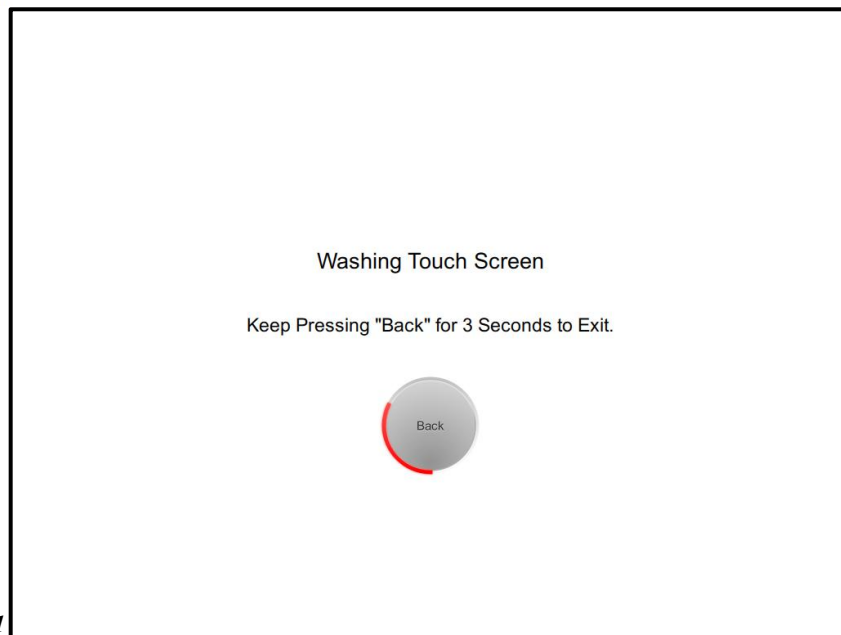

Figure 51

6.2 Relevant Settings

"Settings" provides the operation of time setting, software setting and one-key

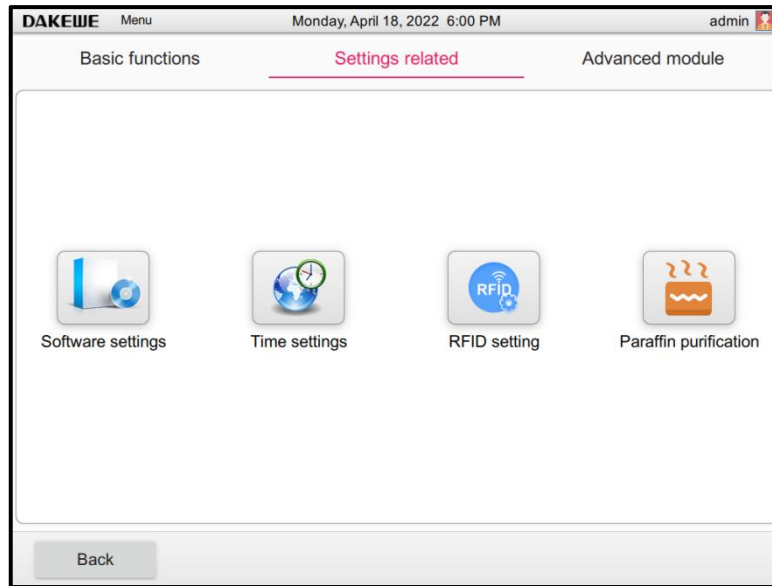

Figure 52

6.2.1 Software Setting



Software Setting

The module allows the user to make basic settings for system language, sound, display, brightness, etc.

6.2.1.1 Language setting

Touch the language setting column to pop up the drop-down box. Select the language, then click the "Apply" button (Figure 53-1). At this time, the modified confirmation restart dialog box pops up, click "OK" to save the modification and restart, click "Cancel" to cancel this modification.

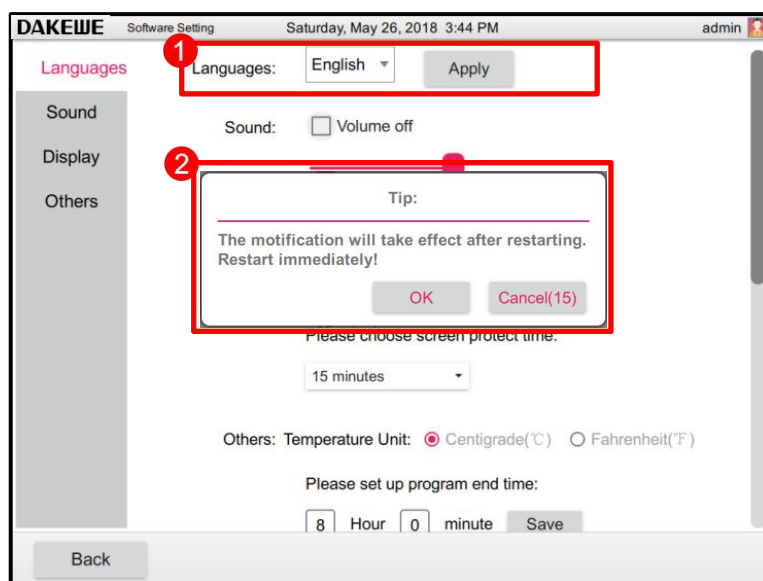

Figure 53

6.2.1.2 Volume setting

Mute: Voice is turned on in the system by default. After checking the mute option, the system will turn off voice (Figure 54-1).

Volume adjustment: The slider can be used to adjust the volume. Swipe to the right with a finger to increase the volume and swipe to the left to decrease the volume.

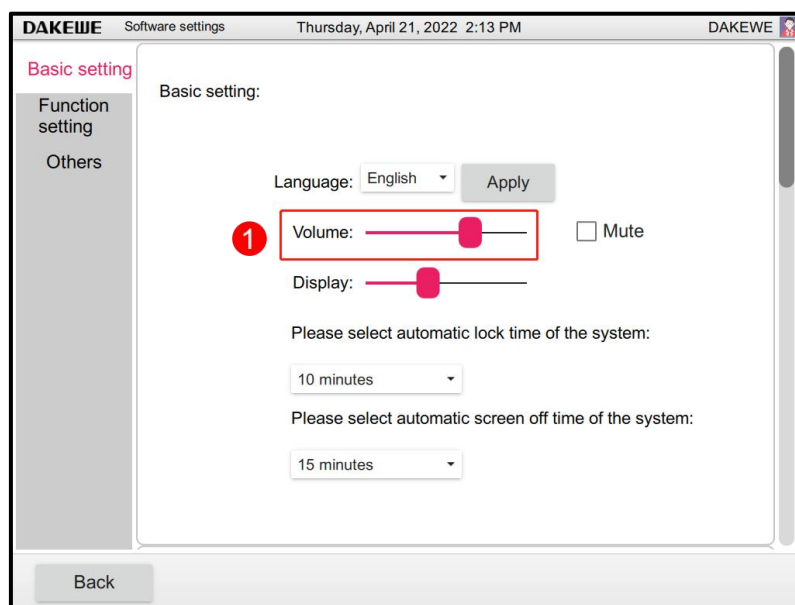

Figure 54

6.2.1.3 Display and brightness setting

Brightness control: The slider can be used to adjust the display brightness. Swipe to the right with a finger to increase the brightness and swipe to the left to decrease the brightness.

Touch the automatic time locking column. Select the time in the drop-down box to complete the system locking time setting. In case the screen is not touched within the set time period, the operating system will lock the screen. It is necessary to log in the account again for unlocking.

Touch the automatic black screen time column. Select the time in the drop-down box to complete the black screen time setting of the system. In case of no system operation within the set time period, the display screen will stop working. Touch the display screen to relight the display screen.

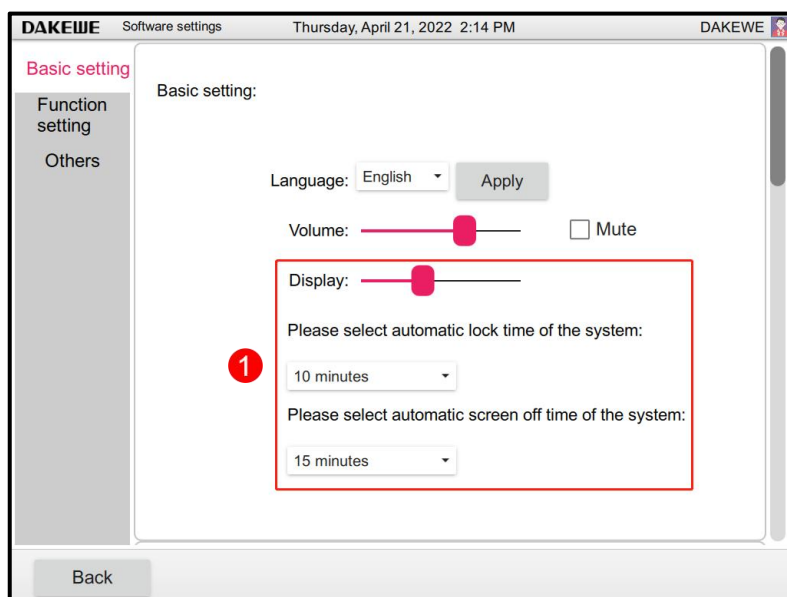

6.2.1.4 Function settings

Turn on the paraffin melting function(*Figure 55-1*) : refer to "Paraffin melting function" in "Boot Setup Preference 2" in Section 6 of Chapter 4.

Turn on the cleaning and baking function(*Figure 55-2*): See "Cleaning and Baking Function" in "Boot Setup Preferences 2" in Section 6 of Chapter 4.

Enable the reagent replenishment function(*Figure 55-3*) : Touch the check box to enable the reagent replenishment function. When the same reagent repeated used during the operation of the program and the current reagent is insufficient, the liquid replenishment will be performed. For example, both S7 and S8 are 100% ethanol, if the reagent level in the reagent tank at S7 site is less than the level required by the retort, the reagent will be extracted from the reagent tank at S8 site and added to the retort , after soaking, all reagents will be discharged to the reagent tank at S7 site.

Enable the reagent automatic rotation function(*Figure 55-4*): The reagent automatic rotation function is enabled by default. Tap to enable the reagent automatic rotation function to enable the following three function modes. 1. Drain out old liquid (Step 1: pumping liquid from the reagent bottle to the retort, Step 2: drain liquid from the retort to the waste liquid tank, Step 3: clean the draining pipe (blow air into the draining pipe for 30S) 2. Refill new liquid (Step 4: refill liquid from the new liquid bottle to the retort, Step 5: drain liquid from the retort to the reagent bottle, Step 6: clean the filling pipe (blow air into the filling pipe for 30s) 3. One-touch reagent rotation (drain old liquid first, then refill new liquid)

Enable the cleaning xylene preheating function(*Figure 55-5*): After the cleaning xylene preheating function is enabled, click Save to set the preheating temperature (40-55 °C). The heating sign and real-time preheating temperature can be displayed at site C1 on the main panel.

Enable concentration detection function (*Figure 55-6*): The concentration detection function is enabled by default. After this function is enabled, HP300 Plus will automatically detect and update the concentration of ethanol reagent in the first step of dehydration process, automatic liquid change and fresh liquid extraction. You can view the real-time ethanol concentration and the preset concentration threshold on the main panel. For details about how to set the concentration threshold, see Section 3 of Chapter 6. Set threshold in reagent quality control.

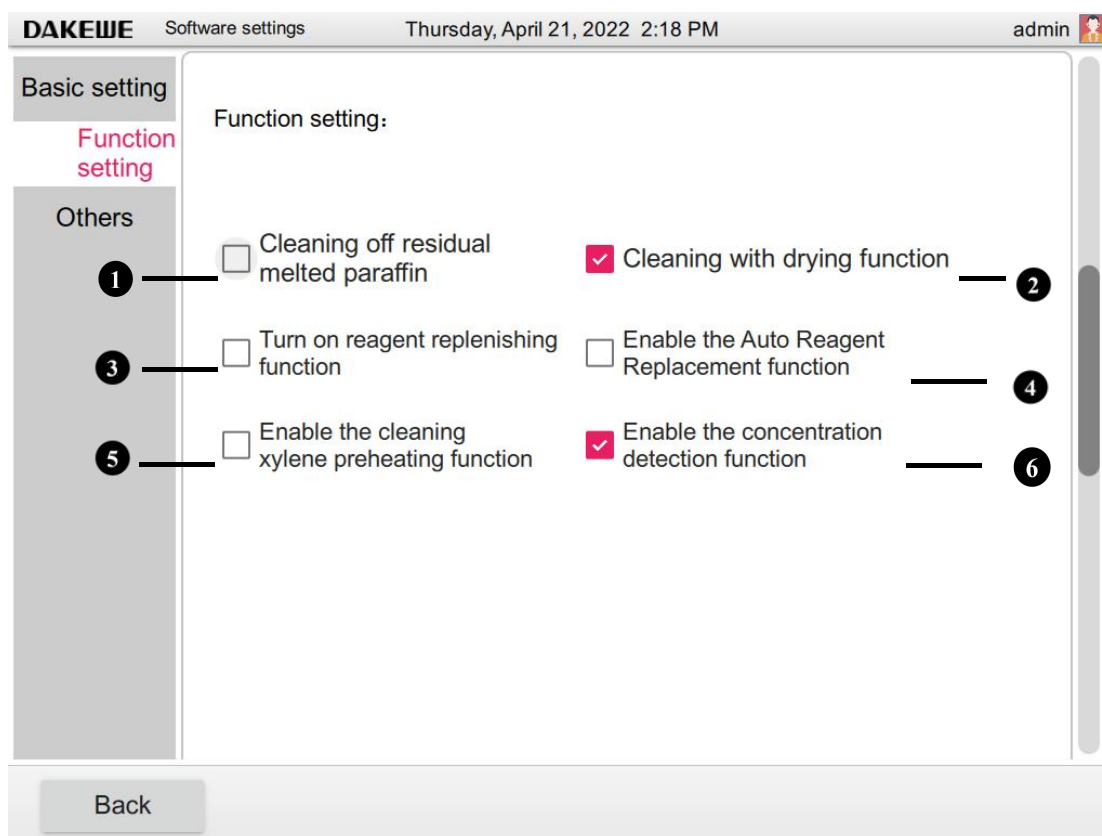

Figure 55

6.2.1.5 Other settings

Temperature format (*Figure 56-1*): The system can be switched between Celsius and Fahrenheit. Touch to activate the corresponding option.

Default setting the program end time (*Figure 56-2*): Touch to input, then click Save. When the program is running with a delay start selected, the system will calculate the start time based on the program's default end time. For instance: The default program end time is set to 8 o'clock in the morning, and the total running time of the program's dehydration program is 10 hours, the device will automatically start the dehydration program at 22 o'clock and end the program at 8 o'clock the next morning.

Stirring time (*Figure 56-3*): Touch to input. The user's dehydration program has enabled the stirring function in some steps (see [5.3.1.1 Dehydration Program Creation](#)). The system will stir according to the set time of this option.

Complete reminder (*Figure 56-4*): This option allows the user to set the alarm time for the completion of the program and the rinse program that is not executed. Click the triangle on the right to pop up the drop-down box to select the desired duration to complete the setting.

Turn off the computer: [See 4.8.5](#).

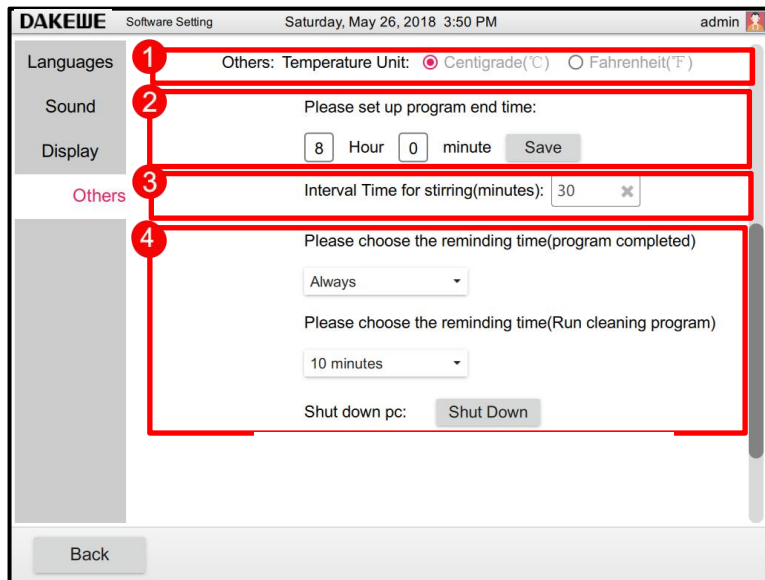

Figure 56

6.2.2 Time Setting



Click the “Time Setting” button in the device management interface to enter the time setting interface (Figure 57). Adjust to set the date (Figure 57-1) and time (Figure 57-2) through the “+,” “-” in the interface. Click “Apply” when finished.

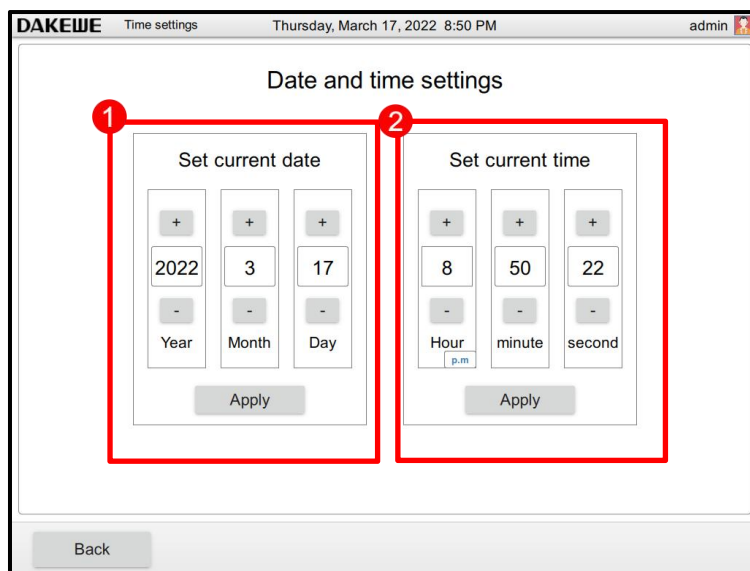
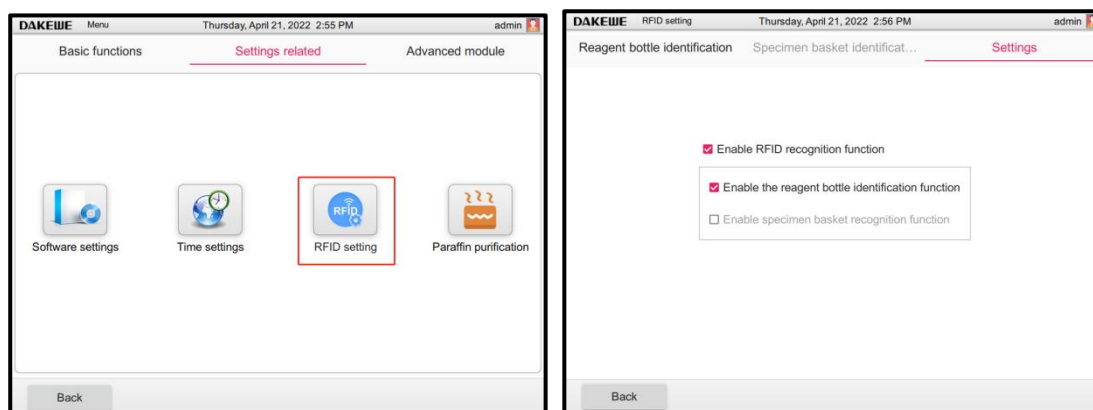
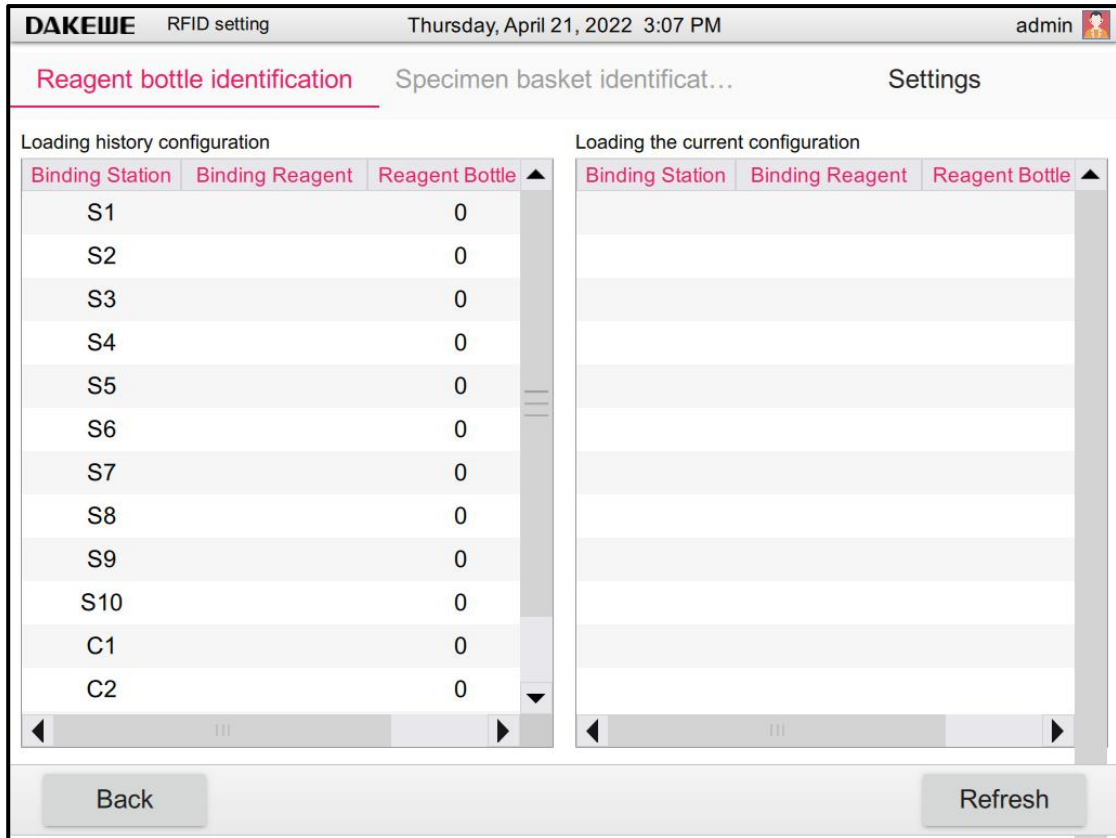

Figure 57

6.2.3 RFID Setting

Menu - Set related interface, click "RFID Settings" button to enter the RFID Settings interface, enable RFID function and reagent bottle identification function in the Settings then reagent bottle identification function can be used. In reagent bottle identification interface, click "Refresh Current Configuration" in the lower right corner to complete reagent bottle ID binding.





6.2.4 Paraffin purification

Click "Paraffin Purification Setting" to enter the paraffin purification setting interface. After the paraffin purification function is enabled, the system will enter the intelligent mode by default. In smart mode, you can set the wind speed and duration. Every day after the cleaning process is finished, the paraffin purification process will be automatically run according to the set value (only once). You can also set the mode to manual. In manual mode, you can set the wind speed (low, middle high three levels), purification duration (15min, 30min, 45min, 60min), purification start time, whether to repeat every day (purification once every day at the start time), start mode (immediate start or delay start); Click Start to start the program.

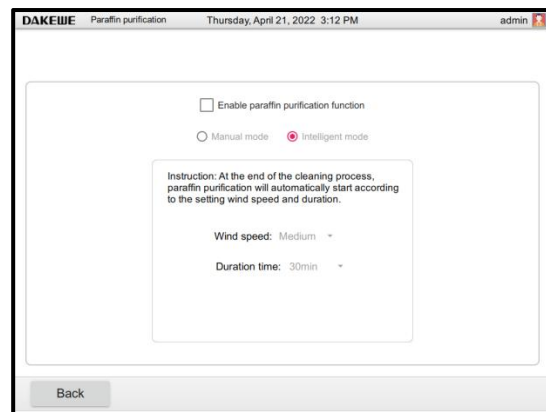
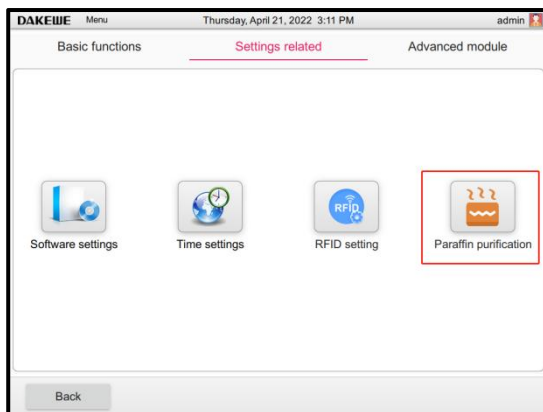

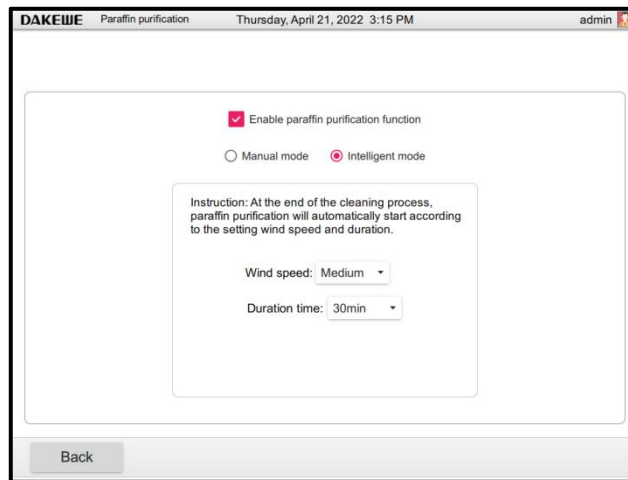
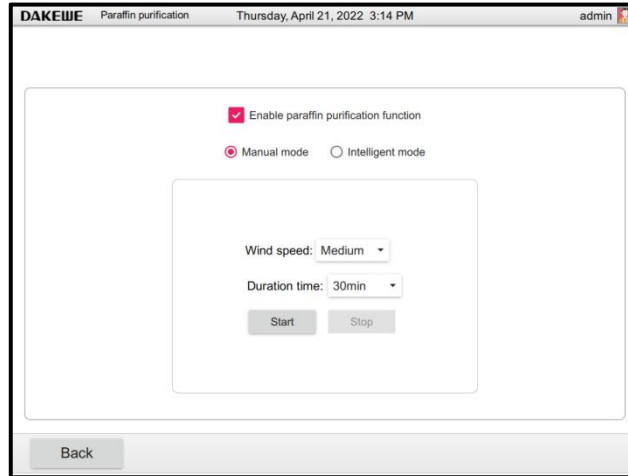

During the operation of paraffin purification, the fan will automatically stop running when the paraffin is in operation or the paraffin is melting and starting, that is, the paraffin purification will be terminated. After the program is finished or paraffin wax is melted, the fan will automatically resume operation.

Before running the fan module, check whether the fan module can be started.

- 1.Total time spent in the fan +1h< the time for the program to reach the position of paraffin in the first step
- 2.Paraffin melting is not turned on

6.3 Advanced Module

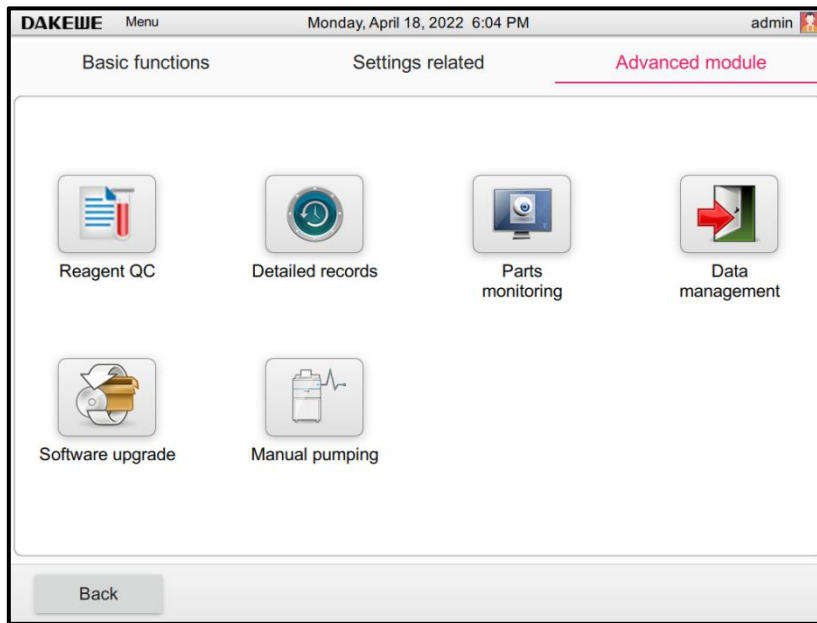

Advanced modules include 5 modules for reagent quality control, historical details, component monitoring, data management and software upgrades.

6.3.1 Reagent Quality Control



Reagents Quality Control

Check to enable the quality control function (*Figure 59-1*).

The system provides the statistical information on site and reagent replacement records (*Figure 59-2*).

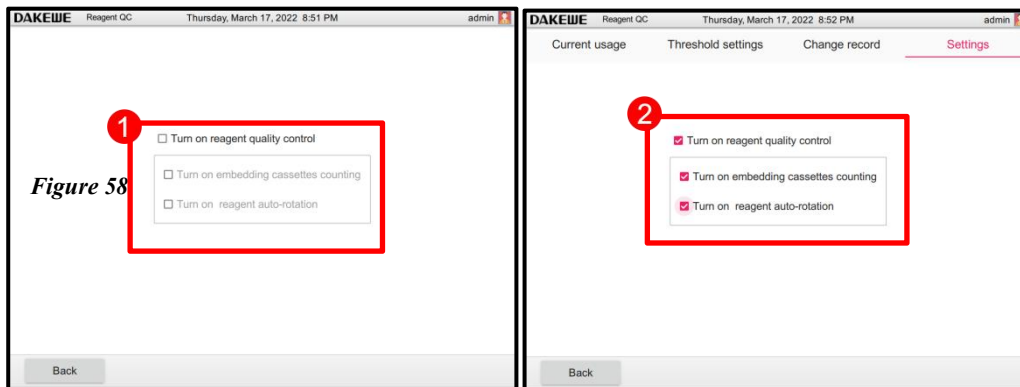

Figure 59



Check the automatic reagent rotation system to manage the reagent concentration according to the reagent filling replacement time, so as to reduce the number of reagent replacements and the sequential shift of the reagent bottles during the reagent replacement.

6.3.1.1 Reagent usage

Touch the “Current Usage” column (Figure 60-1). The system provides the query information on the number of cassettes for the reagent in each site, number of dehydrations, number of days after replacement, current site status, operator and replacement time (Figure 60-2).

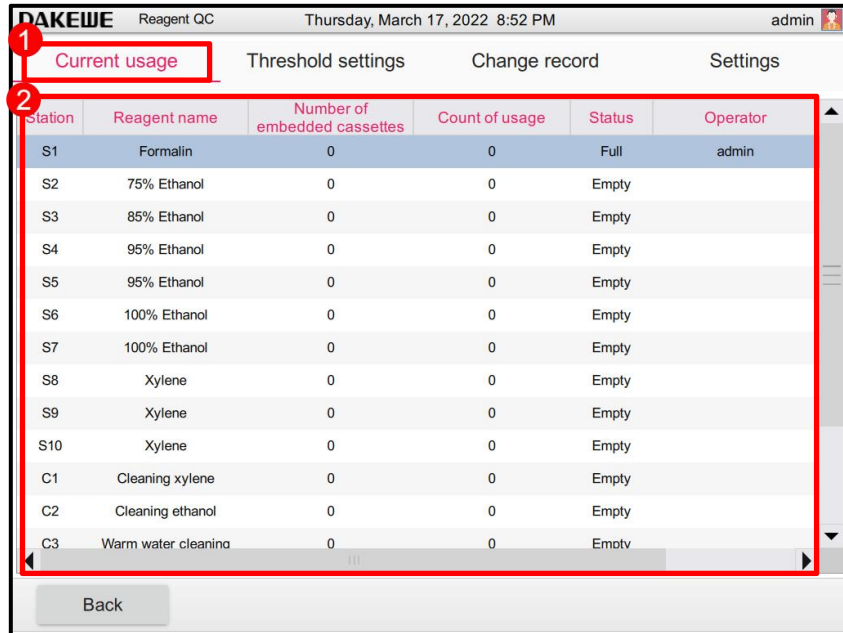

Figure 60

6.3.1.2 Threshold setting

Touch the “Threshold Setting” column (Figure 61-1). Touch to select any reagent. Then, click the “Threshold Setting” button (Figure 61-2). The threshold setting item of the reagent (Figure 61-3) is displayed on the right, including the cassette threshold, threshold of dehydration times and threshold of dehydration days. Enter the threshold in the corresponding setting item. Click OK to finish setting the reagent threshold.

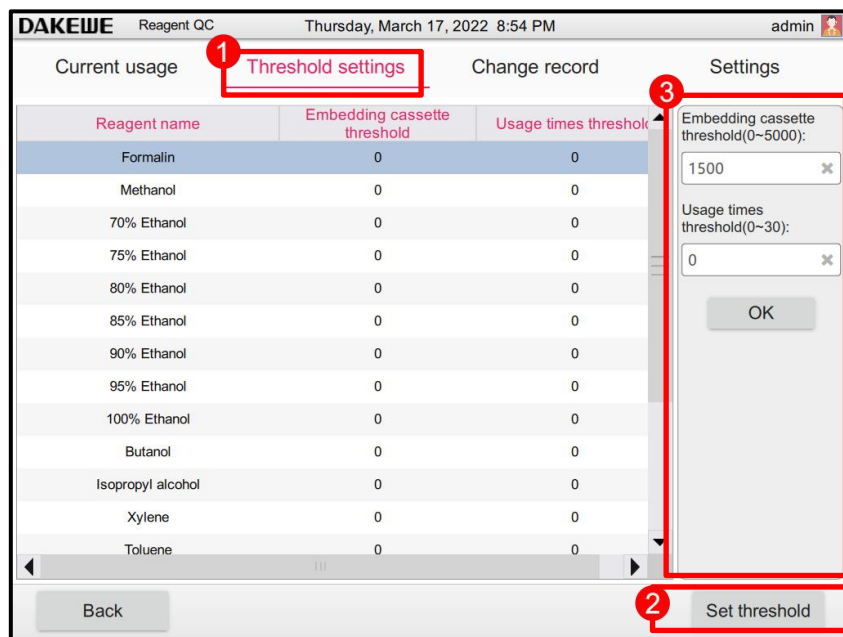

Figure 61

6.3.1.3 Record replacement

Touch the “Record Replacement” column (Figure 62-1). The system provides the query information on the number of cassettes for the reagent in each site, usage days, usage count, replacement date and operators (Figure 62-2).

Station	Reagent	Cassettes Number	Days Used	Usage Times	Change Date	Drain Name	Drain Name
S7	100% Ethanol	0	0	0	2018/05/26	admin	admin
S6	95% Ethanol	0	0	0	2018/05/26	admin	admin
S1	Formalin	0	0	0	2018/05/26	admin	admin
S2	Formalin	0	0	0	2018/05/26	admin	admin
S3	75% Ethanol	0	0	0	2018/05/26	admin	admin
S4	85% Ethanol	0	0	0	2018/05/26	admin	admin
S5	90% Ethanol	0	0	0	2018/05/26	admin	admin
C2	Cleaning Alcohol	0	0	0	2018/05/26	admin	admin
C1	Cleaning Xylene	0	0	0	2018/05/26	admin	admin
C3	Cleaning Water	0	0	0	2018/05/26	admin	admin
S10	Xylene	0	0	0	2018/05/26	admin	admin
S9	Xylene	0	0	0	2018/05/26	admin	admin
S8	100% Ethanol	0	0	0	2018/05/26	admin	admin

Figure 62-1/2

6.3.1.4 RFID function

Reagent sealing function is closed by default, which needs to use the highest permission account to open in Advanced module -> Reagent QC (Figure 62-3).

Reagent Sealing **open Reagent Sealing function**

Turn on reagent quality control

Turn on embedding cassettes counting

Turn on reagent auto-rotation

Figure 62-3

Touch to select the reagent types to seal and set up their maximum usage counts in Basic functions -> Reagent management after the reagent sealing function is opened.

6.3.2 Historical Details



History Details

Click “Historical Details” to enter the historical details interface (*Figure 63*).

It is able to view the statistical information such as start time and end time of the historical running program in the interface.

Touch to select any program. Click the “Degree Details” or “Step Details” button below (*Figure 63-1*) to further query the details of the program.

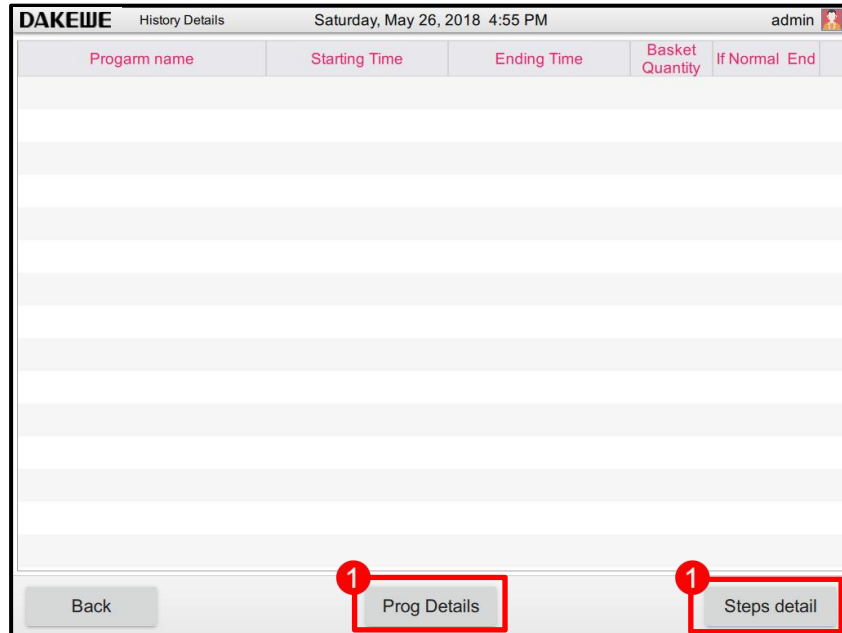

Figure 63

6.3.3 Component Monitoring



Components Monitor

Click “Component Monitoring” to enter the component monitoring interface (Figure 64). The interface provides the statistical information such as service life, frequency of usage, etc. of the automatic tissue processor’s main components.

Device name	Installation date	Elapsed time	Max use time	Times used	Max use times
Dehydrator	2022-03-17	0Day	2920Day	--	--
Solenoid valve 1	2022-03-17	11Hour	8000Hour	0	800000
Solenoid valve 2	2022-03-17	11Hour	8000Hour	0	800000
Solenoid valve 3	2022-03-17	11Hour	8000Hour	0	800000
Solenoid valve 4	2022-03-17	11Hour	8000Hour	0	800000
Solenoid valve 5	2022-03-17	11Hour	8000Hour	0	800000
Solenoid valve 6	2022-03-17	11Hour	8000Hour	0	800000
Solenoid valve 7	2022-03-17	11Hour	8000Hour	0	800000
Solenoid valve 8	2022-03-17	11Hour	8000Hour	0	800000
Air pump	2022-03-17	11Hour	8000Hour	--	--
Liquid pump	2022-03-17	11Hour	2000Hour	--	--
Rotary valve	2022-03-17	--	--	0	150000
Sealing ring of dehydration cylinder	2022-03-17	0Day	730Day	--	--
Electronic lock	2022-03-17	--	--	0	30000
Activated carbon	2022-03-17	0Day	30Day	--	--

Figure 64

6.3.4 Data Management



Data Management

Click to enter the data management interface. The system allows users to export maintenance data, program data, system programs and system operation logs to a USB memory for data recovery and troubleshooting of users or manufacturers.

DAKEWE Data management		Monday, April 18, 2022 6:59 PM	DAKEWE
<p>Exporting Device Data</p> <p>Program log export</p> <p>System log export</p> <p>Maintain data export</p> <p>Clear the database</p>	<p>User data export</p> <p>Program steps export</p> <p>Export quality control report</p> <p>Export reagent replacement records</p>		
<p>Back</p>			



The instrument only supports **FAT32 format USB Disk**.
If the export fails, try to re-export or replace the USB memory after restart.

6.3.5 Manual pumping

In the ready state, click "One-touch drain" from menu-Settings to enter the one-touch drain interface. Select pipeline type - pipeline - liquid level height and drain reagent to check the risk of the pipeline.

The user can fill and drain for three types of pipes: reagent pipes, cleaning pipes and paraffin pipes.

Reagent pipes include S1-S10, cleaning pipes are C1 and C2, and paraffin pipes include W1-W4. In addition, it is necessary to select the liquid level to be extracted, including liquid level 1 and liquid level 2.

Users cannot click any button on the interface to perform other operations in the process of pumping and draining liquid.

Paraffin is pumped and drained to detect whether the temperature of the retort reaches 63°C. If not, the retort will be automatically preheated.

After using the paraffin pipe, click the back button or run the pumping of other pipes, then the user will be forced to carry out standard cleaning.

The states under the one-touch pumping and draining function module mainly include: ready, pumping, draining, pumping completed, reagents insufficient, preheating, pipe blocking

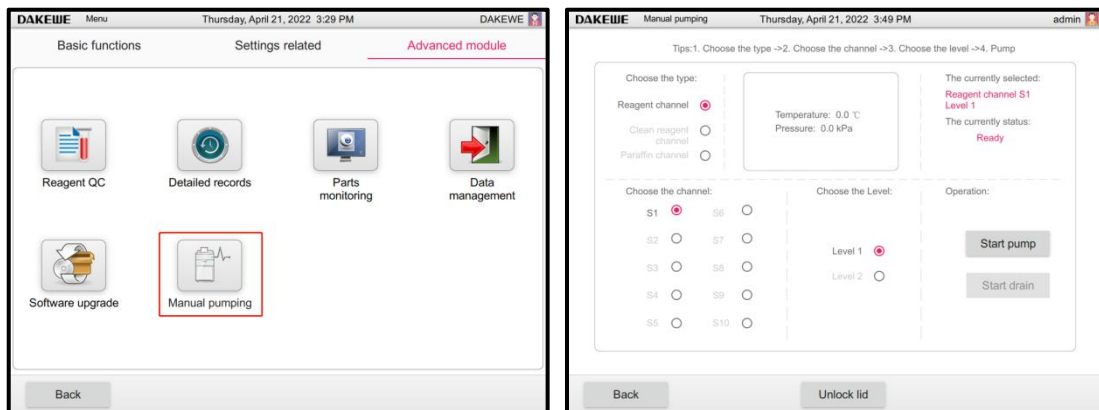

7.Reagent Processing

7.1 Reagent Filling / Evacuation / Replacement



The following steps can only be carried out by trained laboratory personnel with reagent handling experience.

When handling the reagents used in this instrument, be sure to wear personal protective equipment and operate with caution.



Dispose of waste reagents carefully in accordance with local laws and regulations and waste management policies of the Company or organization.

Do not change reagents or fill empty reagent bottles during program operation. This can cause serious damage to the instrument.

Make sure to place the reagent bottle in the correct position according to the reagent bottle layout on the display screen.

1. Remove the reagent bottle from the reagent case. Unscrew the bottle cap (*Figure 66-1*).
2. Thoroughly clean the reagent bottle before refilling.
3. The top and bottom filling liquid level are imprinted on the front of each reagent bottle as a guide. During filling, use a funnel to keep it clean.
4. After filling, the cap needs to be screwed back to the bottle.
5. Put the filled reagent bottle back into the reagent case. When inserting a reagent bottle, make sure that the reagent bottle joint's seal ring is intact and accurately inserted in the socket (*Figure 66-2*). A clicking sound indicates that you have properly installed the reagent bottle in place.



Figure 66

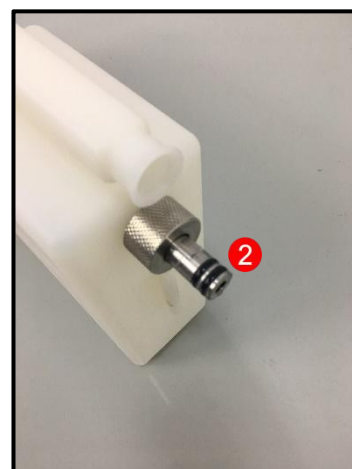

- Data reset in the system's main interface window (Figure 67-4): Click the S1 site icon (Figure 67-1). The filling window pops up (Figure 67-2). After clicking "Fill" (Figure 67-3), click "×" in the upper right corner to exit.

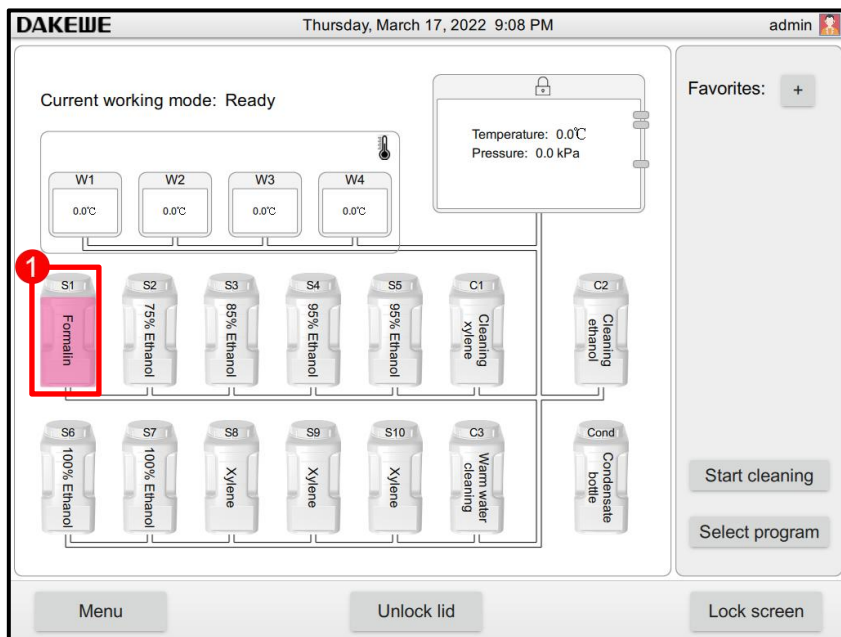
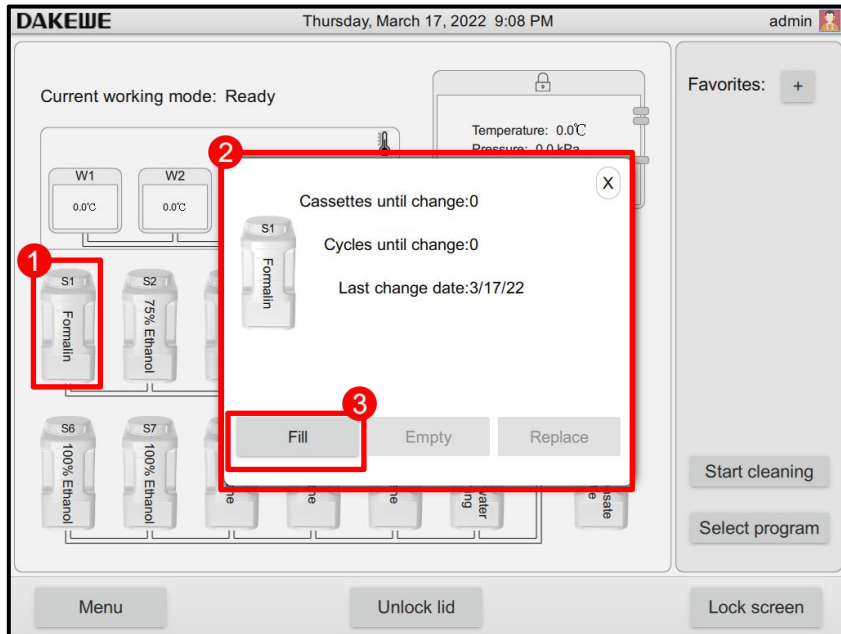

Figure 67



Check the reagent liquid level in the reagent bottle on a flat surface. Be sure to keep the line of sight at the same height as the reagent liquid level to ensure that the reagent volume does not exceed the maximum liquid level, nor does it fall below the minimum liquid level. Insufficient reagents may cause the sample to dry out because it is not sufficiently submerged.

7.2 Paraffin Filling / Evacuation / Replacement

There are two marks on the inner wall of the paraffin cylinder, indicating the highest and lowest filling liquid levels during paraffin filling. The liquid levels must be between these two marks and can be filled with paraffin particles, paraffin blocks or liquid paraffin.

- Set the paraffin melting parameters: Click the temperature icon (*Figure 68-1*). The paraffin temperature setting window pops up. Enter the melting temperature of the filled paraffin (*Figure 68-2*).

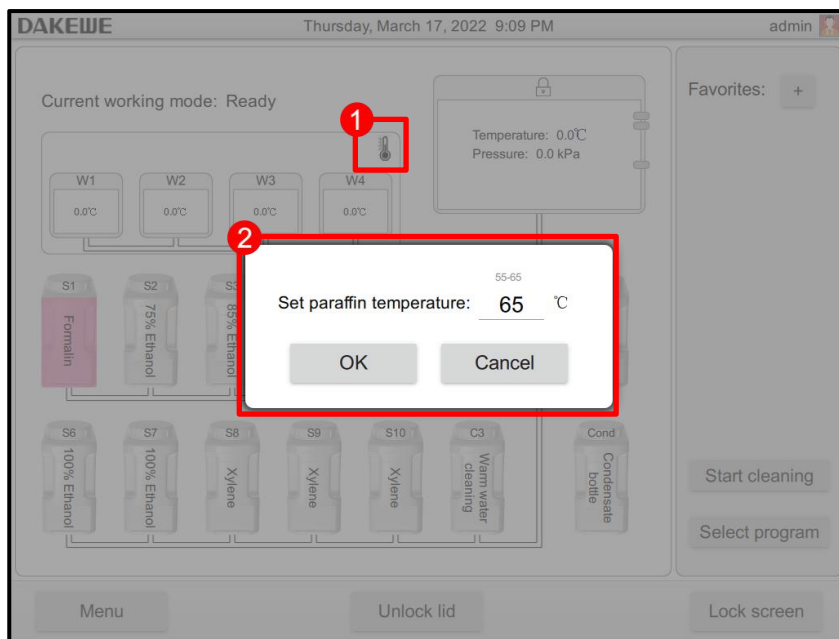
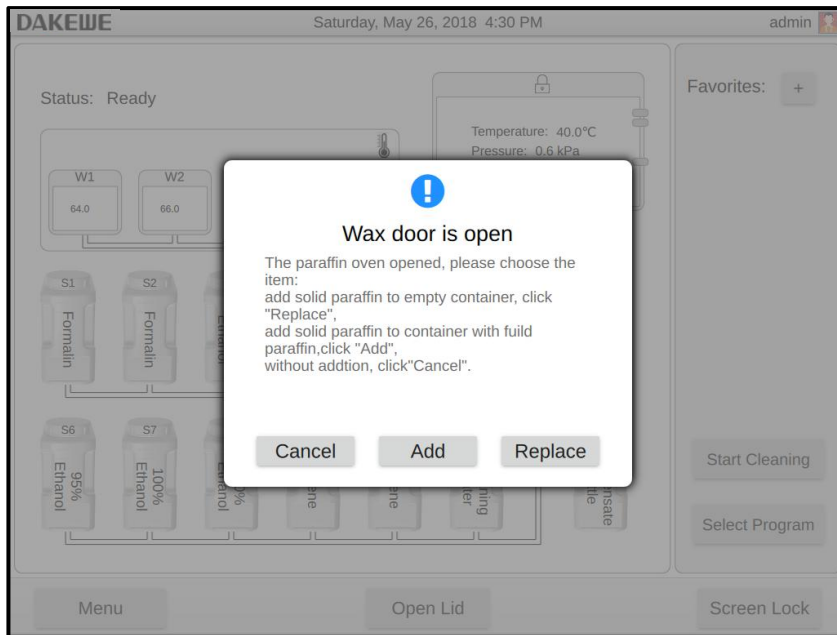

Figure 68

- Open the paraffin case door. A message pops up on the screen to ask what to do (*Figure 69*).

Figure 69



- Pull the paraffin cylinder out of the paraffin case.



Pull out the paraffin cylinder slowly and carefully. Do not yank. The internal paraffin is very hot and can cause burns.

The surface temperature of the paraffin cylinder is also very high. Therefore, when replacing or adding paraffin, be sure to wear protective clothing, goggles, gas masks, rubber gloves and all other necessary personal protective equipment.

- Dispose of the used paraffin into a large container and refill the paraffin cylinder. The marks of the highest and lowest filling liquid levels are located on the inner wall of the paraffin cylinder.
- Push the full paraffin cylinder back into the paraffin case. When inserting the paraffin cylinder, make sure that the paraffin cylinder (male) is aligned with the corresponding paraffin case joint (female). During insertion, a clicking sound indicates that you have correctly installed the paraffin cylinder in place (*Figure 70*). Close the paraffin case door afterwards.



Figure 70

- Click the “Paraffin Replacement” or “Paraffin Filling” in the system interface (Figure 71-1). The system will recalculate the paraffin melting time (Figure 71-2). If adding liquid paraffin, press “Cancel” and the system will not calculate the paraffin melting time.

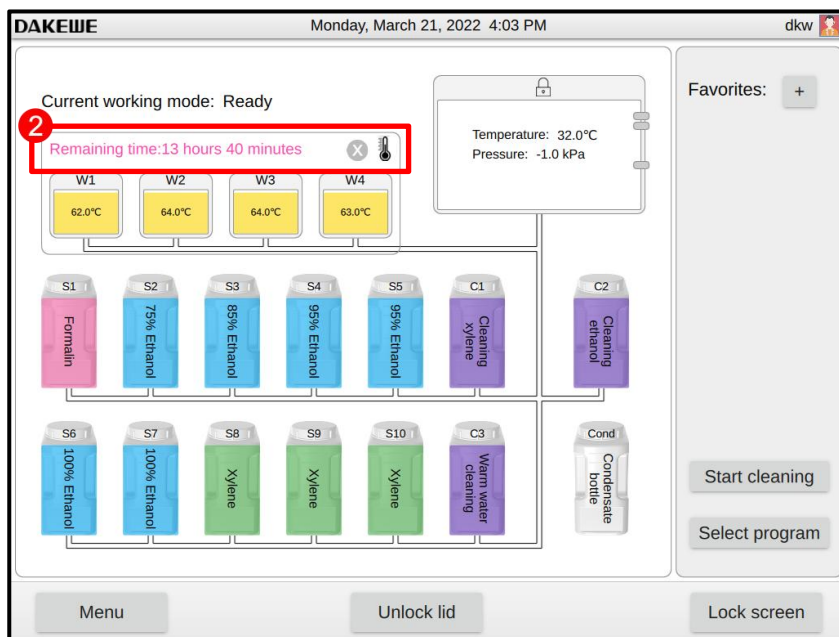
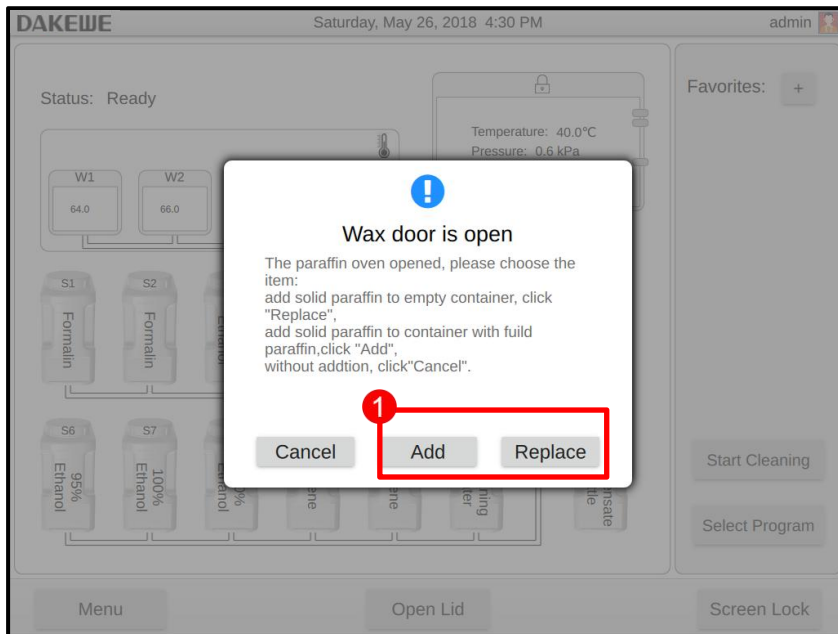

Figure 71

It is recommended to refill the paraffin cylinder one by one.

If the paraffin cylinder is refilled with paraffin with different melting points, the paraffin cylinder needs to be emptied and cleaned. After refilling, reset the melting point of the paraffin cylinder.



If adding the paraffin particles, make sure that paraffin melts completely before the program begins.



7.3 One-button automatic fluid change

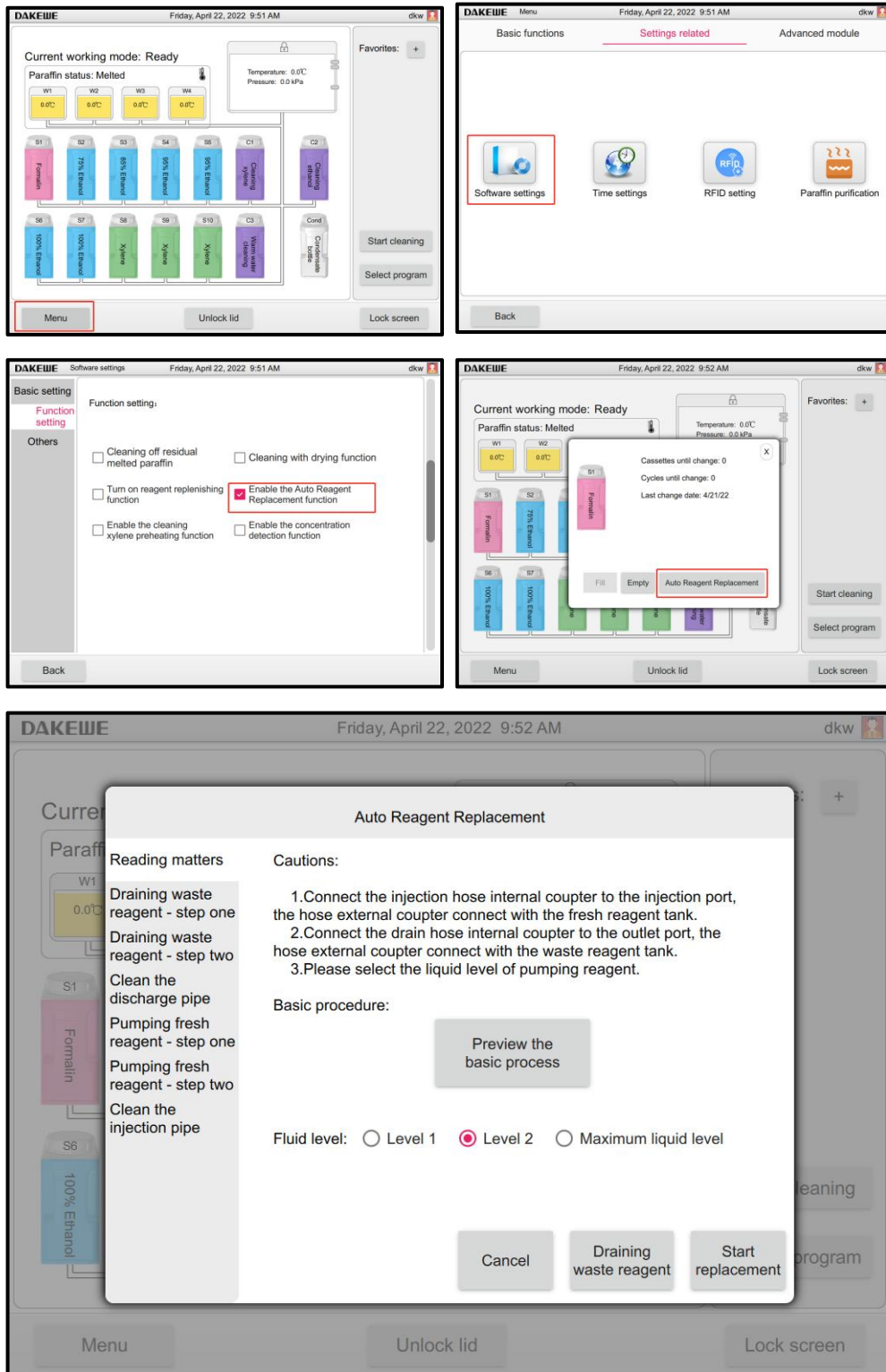

1. Click "Menu" to enter "Software Settings";
2. In the function setting interface, turn on the automatic liquid change function;
3. Return to the main interface, click the label of reagent bottle that needs to be replaced on the main interface, enter the next level, and click reagent automatic rotation.
4. Select the reagent level, you can change the liquid manually (discharge the old liquid and refill the new liquid), or "reagent automatic rotation with one-touch away"

8.Start Program

There are several conditions that must be met to start the program. In order to be able to start the program, the following steps are very important.



Before turning on the instrument, visually inspect the instrument and accessories for any damage that occurs while in transit or moving the instrument. If damage is found, do not operate the instrument and contact your local service agency.

After transporting or moving the instrument, perform a pilot run (preloading program or user-created program) before dehydrating the patient tissue samples to ensure the suitability of the instrument and program used. After successful implementation of all the above tests, the patient tissue samples used for diagnosis can be dehydrated. If any of these steps fails, contact your local service agency.



Check the reagent liquid level and paraffin height before starting the program. Be sure to keep the line of sight at the same height as the reagent liquid level / paraffin to ensure that the reagent / paraffin volume does not exceed the maximum liquid level, nor does it fall below the minimum liquid level. Insufficient reagents / paraffin may cause the sample to dry out because it is not sufficiently submerged.

Check whether the reagent bottle and paraffin cylinder are inserted correctly.



Make sure that the reagent bottle site in the display interface matches the reagent bottle in the reagent compartment correctly.

Check whether the dehydration cylinder strainer is properly installed at the bottom of the dehydration cylinder and that the dehydration cylinder lid is sealed before the program starts.

1. Confirm the prompt message in the main interface: The device functions properly and paraffin has melted.
2. Click the “Open” button in the system interface. The electronic lock automatically opens the dehydration cylinder lid ([See Section 4.4.2](#)).
3. Put the sample basket into the dehydration cylinder.



Use a tissue processing basket during dehydration. Do not place the sample directly into the dehydration cylinder.

Handle the sample carefully and place it in the cassette so that it does not fall into the holes on the dehydration cylinder strainer.

4. After confirming the number of cassettes and tissue processing baskets, close the dehydration cylinder lid. Click the “Close” button in the system’s main interface again.

8.1 Manual Running of the Dehydration Program

8.1.1 Routine operation of dehydration program

- Click the “Select Program” button (Figure 72-1). Select a program in the program list interface. The selected program name and icon are highlighted (Figure 72-2). Check again whether the highlighted program is the one that you wish to run. Then, press “Start” (Figure 72-3).

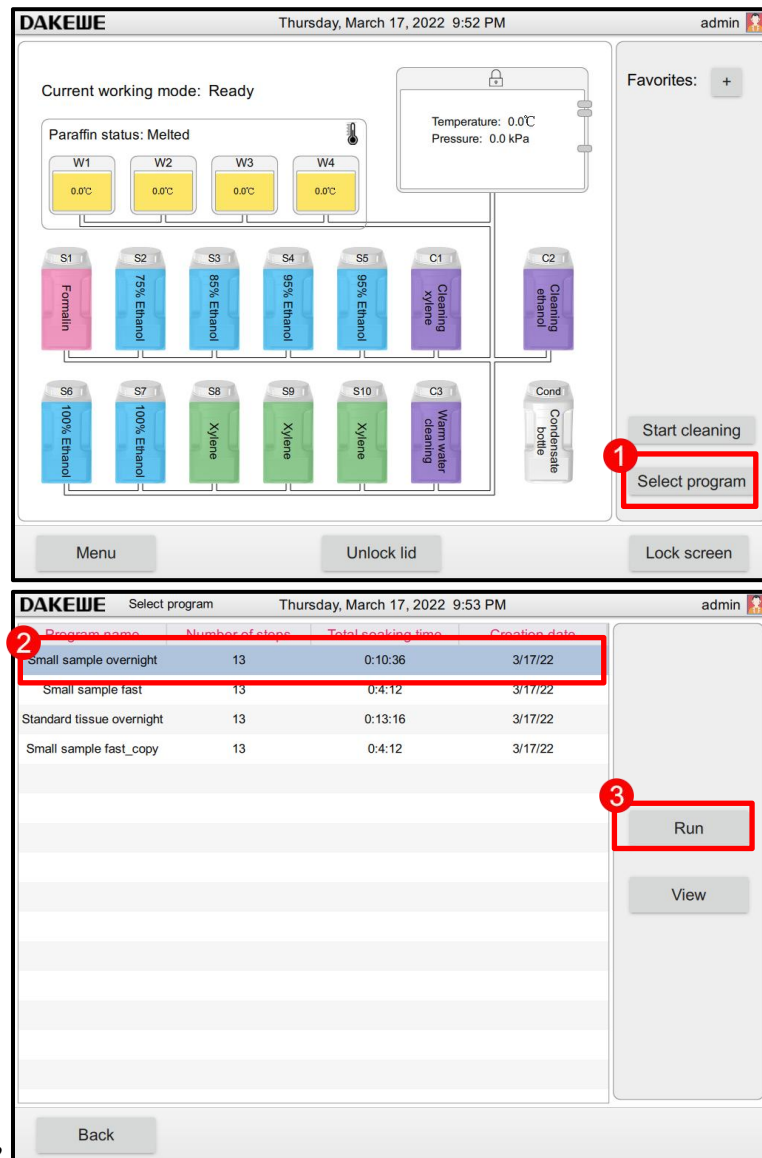

Figure 72

- The confirmation window pops up. After confirmation, click “Next” (Figure 73).

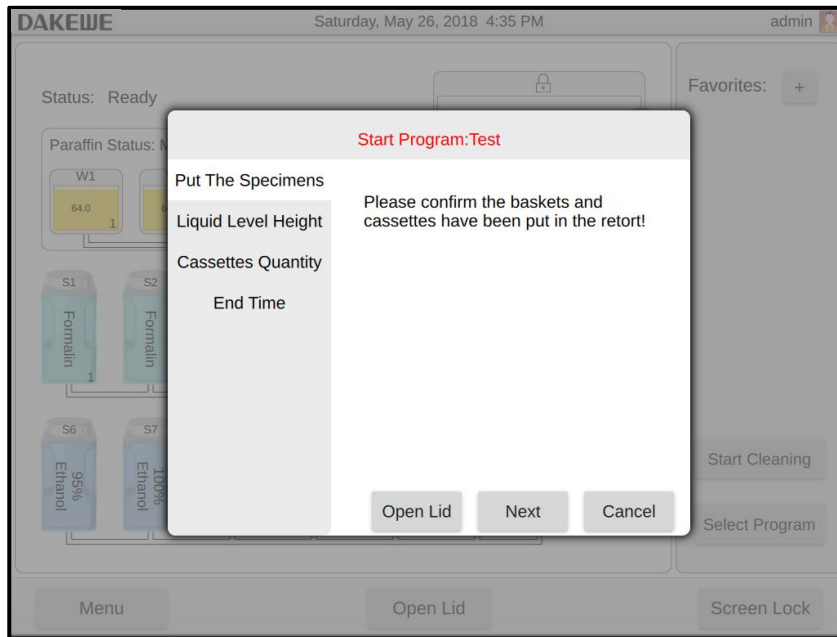

Figure 73

- Select the number of tissue sample baskets (Figure 74).

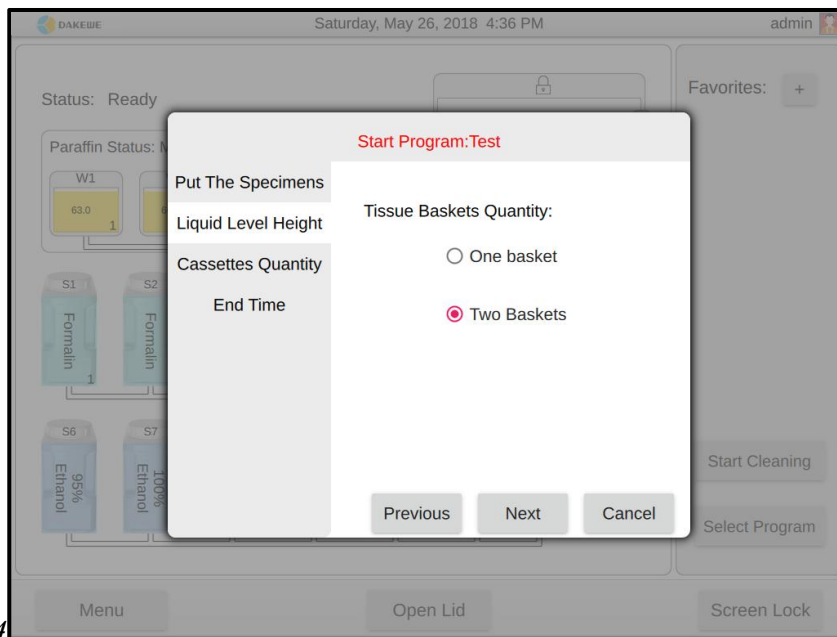

Figure 74

- Enter the number of cassettes, 0-300. After completion, click “Next” (Figure 75).

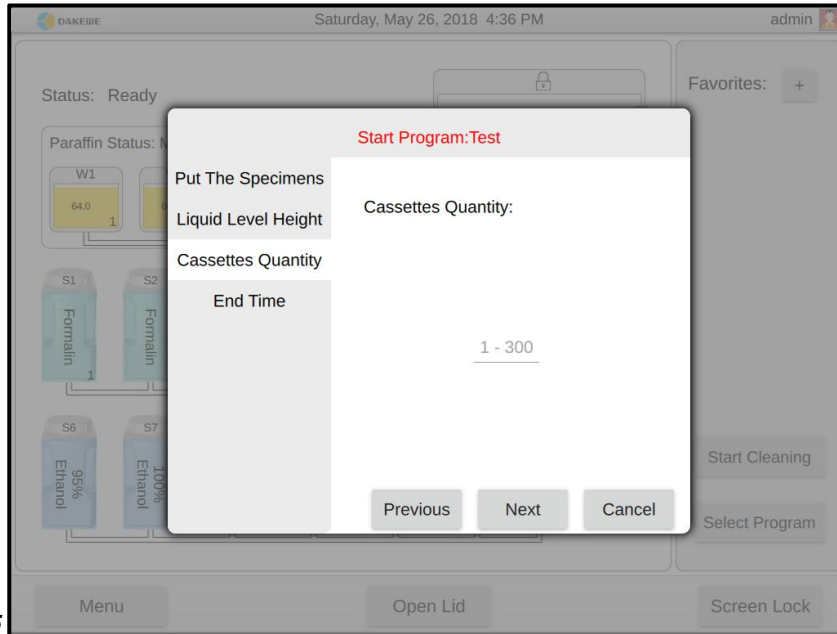

Figure 75



When the number of cassettes is 1 to 150, the number of baskets can be arbitrarily selected; when the number of cassettes is 151 to 300, only two baskets can be selected.

➤ Set the program startup:

After checking “Immediate Start” (Figure 76-1), click the “Run” button. The system will immediately run the dehydration program.

Or, after checking “Delay Start”, click the “Edit Appointment Time” button (Figure 76-2) to enter the appointment setting interface of the program end time (Figure 76-3). After completing the settings in order, click “OK” to exit. Click the “Run” button afterwards. The system will calculate the time that needs to be delayed. The Dehydration program is automatically started when the time arrives.

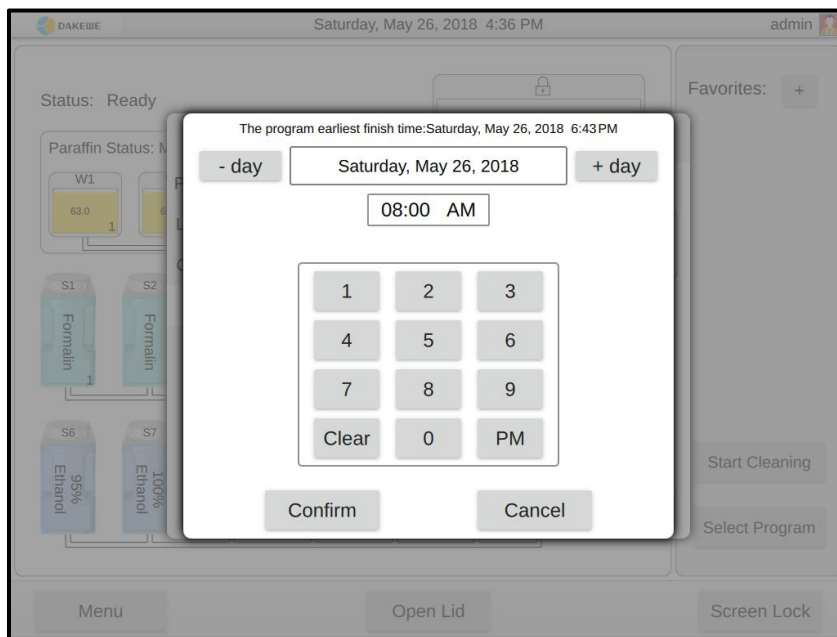
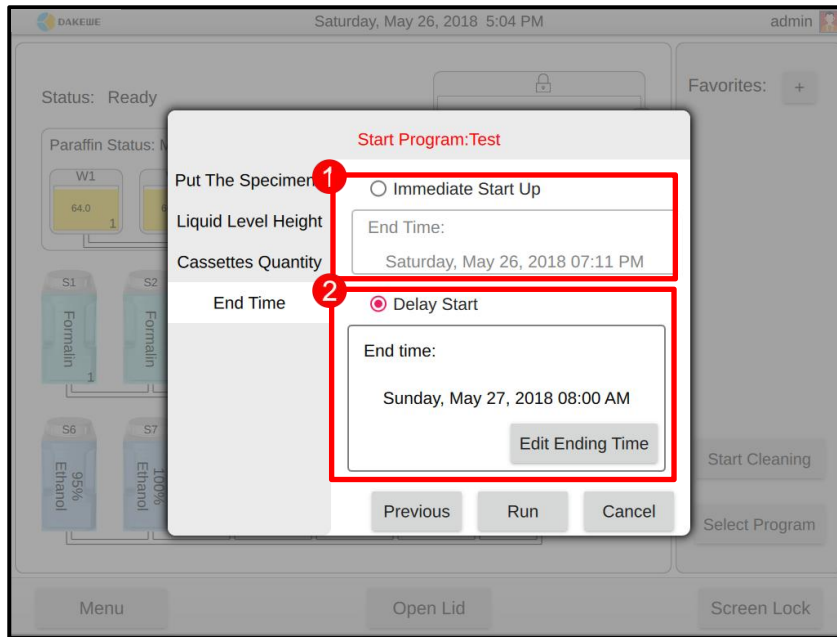

Figure 76

8.1.2 Running the Dehydration Program via Shortcut Keys

The system provides four shortcut keys in the operation status panel for assigning commonly used shortcut programs.

8.1.2.1 Set shortcut keys

In the main user interface, click the “+” button on the shortcut program (Figure 77-1) to enter the program shortcut program setting interface.

All the dehydration programs stored in the system are displayed in the list. The user clicks to select any program (Figure 77-2). Click “Set as Shortcut Program” (Figure 77-3) below. The selected program can be assigned to 4 vacancy shortcut keys (Figure 77-4).

After the program is assigned to a shortcut key, click the “✕” key in the upper right corner of the shortcut program button to reset the program to blank.

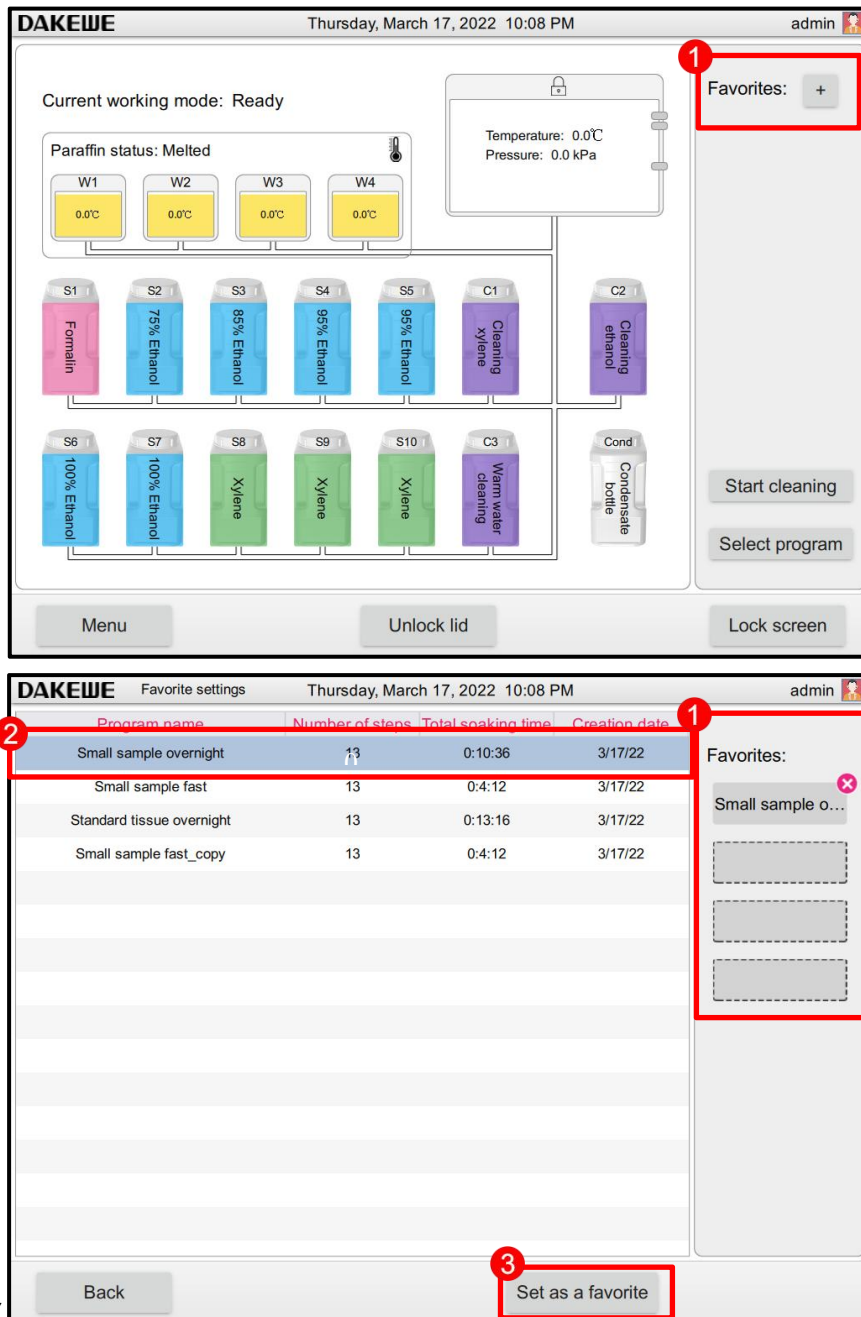

84 Figure 77

8.1.2.2 Shortcut key startup

- Click the assigned shortcut program button. The sample placement confirmation window pops up. After confirmation, click “Next”.
- The cassette quantity window pops up. After entering the number of cassettes, click “Next”.
- Select the number of tissue sample baskets. Click “Next”.
- Set the program end time: Check “Immediate Start”. Click “Run” to directly start the dehydration program.

Or, after checking “Delay Start”, click the “Edit Appointment Time” button (Figure 77-2) to enter the appointment setting interface of the program end time (Figure 77-3). After completing the settings in order, click “OK” to exit. Click the “Run” button afterwards. The system will calculate the time that needs to be delayed. The staining program is automatically started when the time arrives.



During the program operation, do not open the dehydration cylinder lid, or pull out the reagent bottle / paraffin case door / paraffin cylinder, which may damage the instrument or trigger an error report.

8.2 Program Operation Panel

The interface panel during the program operation is shown in the figure below.

The extraction and discharge process of the site in the current step is displayed on the left side of the interface (Figure 78-1).

The program name, expected completion time, number of cassettes, current step, remaining time of the step and other information are displayed on the right side of the interface (Figure 78-2).

Click the “Progress Details” button to view further details (Figure 78-3).

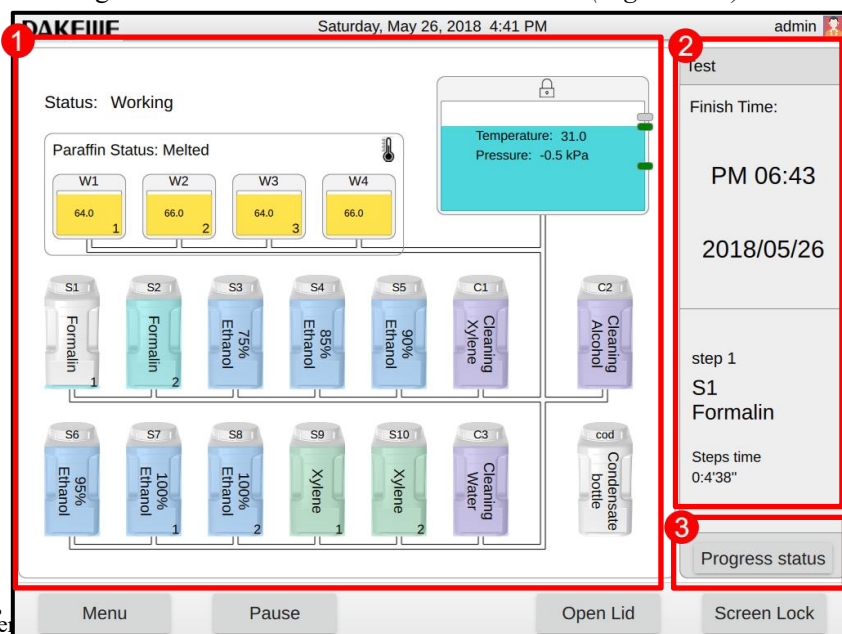

Figure 78-1

8.3 End Program

After the program is completed, the system buzzer will continue to issue a regular alarm sound and a message will pop up on the display screen to indicate “The program has been completed. Will paraffin be emptied?” After pressing “OK”, the alarm sound elimination device starts to discharge paraffin. Refer to 5.3.2.1 for other settings if you need to change the alarm tone duration.

After paraffin is emptied, another message will pop up, indicating that the dehydration cylinder lid is open and the sample baskets can be taken out. The electronic lock has been automatically turned on.

After the tissue sample basket is taken out and the dehydration cylinder lid is closed, a third message box will pop up, indicating that the dehydration cylinder has been polluted. The user places empty tissue sample baskets and runs the rinse program. If the rinse program is not running, the system buzzer will continue to issue regular alarm sounds to remind the user. After clicking to run the rinse program, the alarm prompt will automatically disappear.



The tissue sample baskets are very hot. You must wear gloves when taking out the sample baskets.

9. Cleaning and Maintenance

9.1 Rinse Program



The rinse program is a pre-installed program.

The rinse program cannot be edited, copied or deleted.

After the dehydration program is completed, the rinse program will be given automatically. At this point, the dehydration cylinder must be cleaned. This function cannot be cancelled.

Use only recommended rinse reagents.



Do not open the dehydration cylinder lid during the drying procedures of the rinse program.

Do not pull out the reagent bottle during the operation of the rinse program. Such operation may damage the instrument or trigger an error report.

The sample baskets can be cleaned together in the dehydration cylinder. Only the sample baskets that have gone through standard rinse can be used for dehydration. Xylene for rinse and alcohol for rinse are recommended to be replaced after 5 times of rinse, otherwise it will affect the dehydration effect.

HP300 Plus includes three rinse processes: fast rinse, standard rinse and warm rinse processes. Which are been used in the following situations:

- Fast rinse: After running the dehydration process that does not include the paraffin soaking step, the device can select fast rinse process for system cleaning to save cleaning time.

Table 1: Fast Rinse Process (about 0.5h)

Step	Reagent	Number of cycles	Temperature (°C)	Pressure / Vacuum
1	Xylene for rinse	2	62	Atmospheric pressure
2	Alcohol for rinse	1	60	Atmospheric pressure
3	Positive and negative pressure drying	6	70	Vacuum + positive pressure

- Standard rinse: The default rinse process of the device. After performing a dehydration process that includes the paraffin soaking step, the device is forced to run a standard dehydration process.

Table 2: Standard Rinse Process (about 1.5h)

Step	Reagent	Number of cycles	Temperature (°C)	Pressure / Vacuum
1	Xylene for rinse	5	62	Atmospheric pressure
2	Alcohol for rinse	3	60	Atmospheric pressure
3	Positive and negative pressure drying	6	70	Vacuum + positive pressure

- Warm rinse: It is used for cleaning the crystals that generate and remain inside the machine after long-term use, due to the precipitation of paraformaldehyde in the formalin reagent.

Table 3: Warm Rinse Process (about 1.5h)

Step	Reagent	Number of cycles	Temperature (°C)	Pressure / Vacuum
1	Warm water for rinse	2	62	Atmospheric pressure
2	Alcohol for rinse	1	60	Atmospheric pressure
3	Positive and negative pressure drying	6	70	Vacuum + positive pressure

9.1.1 Rinse Process Step Operation

1. Before running rinse, confirm that all tissue samples inside the dehydration cylinder have been removed;
2. Confirm that the cylinder lid has been locked;
3. Select the type of the rinse process. Click the process button. The system begins to activate the rinse process. The process running steps are displayed in an animated form on the interface;

9.1.2 Rinse Process Precautions

If reagent quality control is enabled in the system, the system will record the number of times the cleaning reagent is used, and prompt the status of the cleaning reagent according to the number of times used.

When the use times of the cleaning reagent has reached the system default maximum use times, the interface will prompt the reagent expiration information and prompt

replacement. The user cannot start the cleaning program without replacing the cleaning reagent. In addition, users can set the threshold of cleaning reagents in the reagent quality control function according to the actual situation of the department. If the number of uses of the cleaning reagent has reached the use threshold, the reagent expired mark will be displayed on the reagent bottle, and the user needs to replace the cleaning reagent.

Table 4: Usage Thresholds for Rinse Reagents

Serial No.	Reagent for rinse	Threshold value
2	Alcohol for rinse	12
3	Xylene for rinse	12



After reaching the usage threshold of rinse reagents, continuous use of the machine for rinse will result in poor rinse effect and may cause damage and malfunction to the instrument.

9.2 Regular Rinse

9.2.1 Daily Cleaning and Maintenance

9.2.1.1 Cleaning the outside of the instrument

- Clean the entire housing, including the instrument exterior, monitor, dehydration cylinder lid, marble workbench, reagent compartment's glass door, paraffin case door and interior. Using a lint-free cloth soaked in detergent.



Do not use organic solvents to wipe the paint surface, warning labels and touch screen. In order to avoid scratching the surface of the instrument, use only the paraffin cleaning spatula provided with the instrument for cleaning. Do not use any metal tools.

9.2.1.2 Cleaning the dehydration cylinder lid

- Use a piece of lint-free cloth to wipe the inner wall of the dehydration cylinder lid. Since the inner wall of the cylinder lid is coated with Teflon coating, the paraffin adhered to it can be easily wiped off. Do not use a paraffin spatula or other hard tools to remove the paraffin, so as to prevent Teflon coating from being destroyed.
- Use a piece of lint-free cloth to wipe the surface of the seal ring on the inner wall of the cylinder lid. During wiping, avoid causing scratches and damages to the surface of the seal ring.

9.2.1.3 Cleaning the dehydration cylinder and sealing ring

- Use a piece of lint-free cloth moistened with xylene or alcohol or detergent to wipe the inner wall of the dehydration cylinder;
- Use a cotton swab moistened with xylene or alcohol or detergent to wipe the outer surfaces of the 3 liquid level sensors on the inner wall of the dehydration cylinder;
- Rotate the fixed knob on the strainer at the bottom of the dehydration cylinder counterclockwise. Remove the filter. Use a piece of lint-free cloth moistened with xylene or alcohol or detergent for wiping.

9.2.2 Weekly Cleaning and Maintenance

9.2.2.1 Cleaning the paraffin case

- Open the paraffin case door. Use a paraffin spatula to remove paraffin from the metal sheet surface of the interior of the paraffin case door. Wipe the surface of the metal sheet with a piece of lint-free cloth moistened with xylene.
- Use a paraffin spatula to remove the paraffin remaining on the shaft of the

paraffin case door. Wipe it clean with a piece of lint-free cloth moistened with xylene.

- A paraffin filter is installed in the paraffin cylinder. If the filter surface has more residual dirt, it can be disassembled for cleaning before being installed in the paraffin cylinder.
- Check the storage capacity of waste wax in the waste wax collection tray. Use your fingers to hook the handle of the waste wax collection tray and pull out until you see the end of the waste wax collection tray. Check whether there is a large amount of waste wax inside, such as waste wax. Too much, you need to remove the waste wax and insert the collection tray back into the storage tank.



Due to high temperature inside and around the paraffin case, gloves shall be worn during cleaning operation. Meanwhile, be careful to prevent burns.

9.2.2.2 Waste liquid collection bottle

- The waste liquid collection bottle must be taken out to empty the waste liquid inside and then be inserted back into the original place every week. Waste liquid evacuation is prompted in the software. It is necessary to promptly empty the waste liquid collection bottle after the prompt.



Due to the corrosiveness and toxicity of the liquid in the waste liquid collection bottle, wear gloves while performing cleaning operation. Meanwhile, be careful to avoid being contaminated by the waste liquid. Furthermore, waste liquid shall be disposed of according to the local laws and regulations as well as the waste management policies of the Company or organization.

9.2.2.3 Dehydration cylinder

- Rotate the fixed bolt of the filter at the bottom of the dehydration cylinder. Remove the strainer of the dehydration cylinder. Remove the solid dirt on the strainer surface and in the filter holes. The strainer can be soaked in xylene or alcohol for cleaning.
- Check the seal ring of the dehydration cylinder lid regularly for damage. If the seal ring is damaged, it must be replaced immediately. The airtightness of the dehydration cylinder can be checked through the software component's quality control data. Meanwhile, the machine itself has the self-checking function of the components. The leakage problem can be analyzed and alarmed. If leakage is found, contact Dakewe Technical Service Department for assistance.



During the strainer removal, make sure that no foreign matters fall into the liquid inlet and outlet at the bottom of the dehydration cylinder.

9.2.2.4 Display Screen

- Use a piece of lint-free cloth to clean the display screen. Click the clean display screen button before cleaning to enter the screen clean state. During a clean state, a short touch on the screen does not trigger any operation buttons.
- After cleaning, press and hold the restore button in the lower right corner of the screen. The interface exits the clean state.

9.2.3 Monthly Cleaning and Maintenance

9.2.3.1 Reagent bottle

- Empty the reagent bottle. Use a brush and warm water for cleaning. After drying, use corresponding reagent to flush the reagent bottle.
- In the cleaning process, be careful not to damage the O-ring of the reagent bottle and to avoid scratches on the surface of the seal ring.
- The seal ring on the joint can be lubricated with the seal ring lubricant provided with the machine, so as to ensure the sealing effect of the seal ring and the smoothness of plugging and unplugging.
- After cleaning, refill the reagent bottle. Screw the bottle cap. Insert the bottles in the correct order into the reagent compartment. Check whether the blue indicator light of the reagent bottle is on and check whether the liquid level of each reagent bottle meets the requirements for the minimum liquid level.

9.2.3.2 Paraffin case

- Before cleaning the paraffin case, TURN OFF the instrument and wear personal protective equipment such as protective clothing, goggles, gas masks, rubber gloves, etc.
- The cleaning process requires careful operation to avoid burns caused by skin contact with the interior or the periphery of the paraffin case.
- Use a piece of lint-free cloth to wipe the interior of the paraffin case and the metal plate surface of the paraffin case door.
- Use a piece of lint-free cloth to wipe the seal ring of the paraffin case door.

9.2.4 Reagent Rinse

The following cleaning reagents are recommended for cleaning the instrument:

- 70% alcohol;
- Paraffin removing agent (xylene or isopropanol);
- Distilled water.

9.3 Regular Maintenance

Table 5: Maintenance Table

Serial No.	Maintenance	Day	Week	Month	Feb.
1	Use a piece of lint-free cloth to dip recommended detergent to clean the outer surface of the instrument.	√			
2	After each rinse program of the dehydration cylinder, dry the dehydration cylinder and cylinder lid.	√			
3	Check and clean the liquid level sensor.	√			
4	Check the paraffin liquid level. Refill when necessary.	√			
5	Check the filling liquid level in the reagent bottle.	√			
6	Check whether the reagent bottle has been fully inserted into the connector.	√			
7	Clean the waste paraffin collection tray.		√		
8	Remove the paraffin residuals on the internal surface of the paraffin cylinder. Check the paraffin cylinder filter.		√		
9	Check and empty the waste liquid collection bottle. Clean the air intake.		√		
10	Check the dehydration cylinder filter for any tissue or paraffin residue.		√		
11	Check and clean the seal ring of the dehydration cylinder lid.		√		
12	Clean the monitor.		√		
13	Clean the interior of the reagent bottle. Lubricate the seal ring of the reagent bottle. Check for damage. Make sure that the protective cap and seal ring of the reagent bottle are covered and tightly closed.			√	
14	Check the seal ring of the paraffin case door. Clean the paraffin case.			√	
15	Replace the active carbon filter.				√

10. Troubleshooting

10.1 Fault Alarm Type

The processor's fault type is divided into 3 levels

Table 6: Fault Alarm Type Table

Serial No.	Type	Fault alarm description	Alarm mode
1	Danger	Imminent danger, if not avoided, it will cause death or serious injury.	Monitor display + alarm indicator + voice reminder
2	Warning	Potential risks, if not avoided, it will cause serious injury or severe damage to the machine.	Monitor display + alarm indicator + voice reminder
3	Note	Matters requiring attention or help information.	Monitor display

10.2 Troubleshooting

When HP300 Plus fails, take the following steps for processing:

- Read error messages.
- Operate according to the description of the message prompt.
- Check the running log for fault message history. Perform troubleshooting according to the fault message history.
- Check the system's quality control records for any parameter anomalies. Feedback the parameter anomalies to the Dakewe Technical Service Department.

10.2.1 Power Failure

If the machine is unable to be turned on, perform a power check as follows:

- Check whether the power plug is inserted into the socket and whether the socket is powered on;
- Make sure that the current leakage protection switch on the back of the instrument is closed.



If you still cannot solve the problem through the above steps, contact Dakewe Technical Services.

10.2.2 Safety Protection Reagent

The top priority is to protect the tissue samples in the current running program and to prevent the tissue samples from being damaged due to environmental changes. In the event of failure or device failure, the system will proceed according to the following process:

- If a fault occurs, local and remote alarms will be issued.
- The alarm information reminds the user to remove the samples. If the samples are not removed after 5 minutes, the system will fill the dehydration cylinder with the safety reagent to ensure the safety of the samples.
- If the safety reagent filling process cannot be completed, it may be due to insufficient safety reagents, blocked flow channels or system leakage. At this point, the dehydration cylinder lid can be opened to check the liquid level of the reagent in the cylinder. If the liquid level is insufficient, the dehydration cylinder shall be turned off to empty the reagent. Add safety reagents to the appropriate amount of liquid.
- In case of power failure, the dehydration cylinder lid shall be opened to remove tissues through manual unlocking mechanism. If power recovered, the system will reheat according to previous settings, and extract appropriate safety reagents to fill the dehydration cylinder to ensure the samples safety.

Table 7: Safety Protection Reagent Table

Serial No.	Reagent type in the fault step	Corresponding safety protection reagent
1	Formalin (fixed)	Formalin
2	Alcohol (dehydrated)	Formalin
3	Xylene (clearing)	Xylene
4	Paraffin	Paraffin (heating)

If there is no program running during power failure, the instrument will be in standby mode after the power is restored.

10.2.3 Electronic Lock

The electronic lock is controlled by software. If the opening and closing function fails, manual operation can be performed in the following manners:

- Open the active carbon door under the marble platform. You can see the manual knob of the electronic lock. Rotate the manual knob clockwise for approximately 150 turns until it can no longer be rotated. The electronic lock can be unlocked.
- After closing the dehydration cylinder lid, rotate the manual knob counterclockwise for approximately 150 turns until it can no longer be rotated. The electronic lock can be locked.

11. Warranty and Service

11.1 Warranty

Dakewe guarantees that the delivered contract products adopt a comprehensive quality control program based on Dakewe's internal testing standards, and that the products are intact and meet all technical specifications.

The scope of the warranty is based on the content of the agreement. For special warranty services, contact your local sales representative or the dealer who sells the instrument.

11.2 Technical Service Information

If technical service or component replacement is required, contact Dakewe's local sales representative or dealers who sell the instrument.

The following information shall be provided:

- Model name and serial number of the instrument.
- Instrument location and contact name.
- Reason for the service request.
- Delivery date.

11.3 Scrapping and Disposal

The instrument or instrument components must be disposed of in accordance with local regulations.



12. Hazardous Substance Information

Names and Contents of the Hazardous Substances in the Product

Component name	Hazardous substance					
	Lead (Pb)	Mercury (Hg)	Cadmium (Cd)	Chromium VI (Cr(VI))	Polybrominated biphenyls (PBB)	Polybrominated diphenyl ethers (PBDE)
Printed circuit board	×	○	×	○	○	○
Electronic parts and components	×	○	×	○	○	○
Mechanical components	×	○	○	○	○	○
Cable	×	○	○	○	○	○

This form is prepared based on the provisions of SJ/T 11364-2014.

○: It indicates that the content of this hazardous substance in all homogeneous materials of the component is below the limit requirements specified in GB/T 26572.

×: It indicates that the content of this hazardous substance in at least one of the homogeneous materials of the component exceeds the limit requirements specified in GB/T 26572.

The toxic and harmful substances or elements in the product within the above-mentioned period of time from the date of production shall be complied with in accordance with the safety and usage precautions of the product described in the user manual and without any other legal or regulatory exception. No leakage or abrupt change will occur. The use of this product will not cause serious pollution to the environment or cause serious damage to the user's person or property. The "environment-friendly use period" is not a period of safe use, and is particularly different from the period of use that is limited based on factors such as electrical performance safety and electromagnetic safety.

When the product is discarded after it has been used properly, it is expected that the product will be disposed of in accordance with laws and regulations on the collection and reuse of electronic information products.

13. Electromagnetic Compatibility Indicators

Note:

[HP300 Plus] [Automatic Tissue Processor] shall meet the emission and immunity requirements specified in IEC61326-2-6, as shown in the table below.

The user shall be responsible for ensuring the electromagnetic compatibility of the environment for the equipment to work normally.

It is recommended to evaluate the electromagnetic environment before the equipment is used.

Warning:

[HP300 Plus] [Automatic Tissue Processor] is designed and tested according to Class A equipment in CISPR 11. In the home environment, the equipment may cause radio interference, so that protective measures should be taken.

It is prohibited to use the equipment next to an intense radiation source (such as an unshielded RF source), otherwise the normal operation of the equipment will be affected.

Table I: Electromagnetic emission

Electromagnetic emission	
Emission test	Compliance
CISPR 11 conducted emission	Group 1, Class A
CISPR 11 radiated emission	
IEC61000-3-2 harmonic emission	N/A
IEC61000-3-3 voltage fluctuation/scintillation emission	N/A

Table II: Electromagnetic immunity

Electromagnetic immunity			
Immunity test items	Basic standards	Test values	Performance criteria
Electrostatic discharge (ESD)	IEC61000-4-2	Contact discharge: $\pm 2\text{kV}$, $\pm 4\text{kV}$ Air discharge: $\pm 2\text{kV}$, $\pm 4\text{kV}$, $\pm 8\text{kV}$	B
Radio frequency electromagnetic field	IEC61000-4-3	3V/m (80 MHz-1GHz) 3V/m (1.4GHz-2GHz) 1V/m(2.0GHz-2.7GHz)	A
Pulse cluster	IEC61000-4-4	Power cord: $\pm 1\text{kV}$ (5/50ns,5kHz)	B
Surge	IEC61000-4-5	Line to ground: $\pm 2\text{kV}$ Line to line: $\pm 1\text{kV}$	B
Radio frequency transmission	IEC61000-4-6	Power cord: 3V, 150kHz- 80MHz, 80%AM	A
Power frequency magnetic field	IEC61000-4-8	3A/m, 50/60Hz	A
Voltage sag and interruption	IEC61000-4-11	1 cycle, 0%	B
		5/6 cycle, 40%;	B
		25/30 cycle, 70%;	C
		250/300 cycle, 5%	C
Performance criteria: A. In the test, the performance is normal within the specified limit. B. In the test, the function or performance is degraded or lost temporarily, but can restore automatically. C. In the test, the function or performance is degraded or lost temporarily, and cannot restore until reference or system operation by the operator			

14.RFID-Registration for the United States of America and Canada

●Symbol on the Identification Label:



FCC ID: 2A9670204

●Title of Symbol:

FCC-Approved Equipment

●Compliance statements :

This device complies with Part 15 of the FCC Rules and with Industry Canada licenceexempt RSS standard(s). Operation is subject to the following two conditions:

- (1) this device may not cause harmful interference, and
- (2) this device must accept any interference received, including interference that may cause undesired operation.

●Note

This equipment has been tested and found to comply with the limits for a Class B digital device, pursuant to part 15 of the FCC Rules. These limits are designed to provide reasonable protection against harmful interference in a residential installation. This equipment generates, uses and can radiate radio frequency energy and, if not installed and used in accordance with the instructions, may cause harmful interference to radio communications. However, there is no guarantee that interference will not occur in a particular installation. If this equipment does cause harmful interference to radio or television reception, which can be determined by turning the equipment off and on, the user is encouraged to try to correct the interference by one or more of the following measures:

- Reorient or relocate the receiving antenna.
- Increase the separation between the equipment and receiver.
- Connect the equipment into an outlet on a circuit different from that to which the receiver is connected.
- Consult the dealer or an experienced radio/TV technician for help.

Changes or modifications not expressly approved by the party responsible for compliance could void the user's authority to operate the equipment.

DAKEWE

Name of manufacturer: Dakewe (Shenzhen) Medical Equipment Co., Ltd.

After-sales service unit: Dakewe (Shenzhen) Medical Equipment Co., Ltd.

Registered address: Floor 5, Building B, No.2 Luhui Road, Jinsha Community, Kengzi Street,
Pingshan District, Shenzhen,China.

Production address: Floor 5, Building B, No.2 Luhui Road, Jinsha Community, Kengzi Street,
Pingshan District, Shenzhen,China.

Tel: 0755-26413421

Fax: 0755-27383156

Customer Service: 400-6304366

Website: <http://www.dakewemedical.com/>

Authorized Representative of the EU:

SUNGO Europe B.V.

Fascinatïo Boulevard 522, Unit 1.7, 2909VA Capelle aan den IJssel, The Netherlands

Authorized Representative of the UK:

SUNGO Certification Company Limited

3rd floor, 70 Gracechurch Street, London. EC3V 0HR