

# **Fibocom Auto Inc.**

# **AW916-GL Series Module Hardware User**

# **Guide**

Document Version: 1.5

Release Date: 2022-05-12

# Applicable Model

No.	Model	Software Baseline	Applicable Customers	Description
1	AW916-GL	--	--	--

# Change History

Version	Date	Author	Reviewer	Approver	Description of change
1.0	2020-11-30	Sang Wenbo Ma Baihui	Li Gao	Dai Wenhui	Initial version
1.1	2020-12-03	Sang Wenbo	Li Gao	Dai Wenhui	Updated the hardware block diagram
1.2	2021-02-19	Sang Wenbo	Li Gao	Dai Wenhui	Modified the WiFi parameters.
1.3	2021-02-27	Ma Baihui	Li Gao	Dai Wenhui	Added the reference circuit and electrostatic protection
1.4	2021-05-14	Che Qingcheng	Li Gao	Dai Wenhui	Updated power consumption indicators
1.5	2021-08-17	Ma Baihui Che Qingcheng	Li Gao	Dai Wenhui	<ol style="list-style-type: none"><li>1) Updated the reference packaging of the module</li><li>2) Added the time sequence of power-on and power-off</li><li>3) Added the definitions of some pins</li><li>4) Added the PCIe wiring rules</li><li>5) Added the Bluetooth-related content</li></ol>

## Copyright

Copyright ©2018-2022 Fibocom Auto Inc. All rights reserved.

Without the prior written permission of the copyright holder, any company or individual is prohibited to excerpt, copy any part of or the entire document, or transmit the document in any form.

## Notice

The document is subject to update from time to time owing to the product version upgrade or other reasons. Unless otherwise specified, the document only serves as the user guide. All the statements, information and suggestions contained in the document do not constitute any explicit or implicit guarantee.

## Trademark



The trademark is registered and owned by Fibocom Auto Inc.



The trademark is registered and owned by Fibocom Wireless Inc.

## Contact

Website: <https://www.fibocom.com/en/>

Address: Floor 13, Building A, Shenzhen International Innovation Valley, First Stone Road, Xili Community, Xili Street, Nanshan District, Shenzhen

Tel: +86 755-26733555

# Contents

---

Applicable Model.....	2
Change History .....	2
1 Foreword .....	6
1.1 Introduction .....	6
1.2 Safety Instruction .....	7
2 Product Overview .....	9
2.1 Introduction .....	9
2.2 Main Performance .....	9
2.3 Hardware Block Diagram.....	9
3 Application Interfaces .....	11
3.1 Overview .....	11
3.2 Pin Distribution .....	11
3.3 Pin Definition .....	12
3.4 Power Supply .....	15
3.5 Power Supply Time Sequence.....	16
3.6 Power Consumption.....	17
3.7 PCIe Interface.....	18
3.7.1 Interface Description.....	18
3.7.2 PCIe Wiring Rules .....	18
4 Antenna Interface .....	19
4.1 RF Antenna Interface Configuration.....	19
4.2 Operating Bands.....	19
4.3 Reference Design .....	19
4.4 Antenna Specification Requirements.....	23
5 Electrical Characteristics and Reliability.....	25
5.1 Electrical Characteristics .....	25
5.2 WiFi Performance Indicators.....	25
5.3 BT Performance Indicators .....	27
6 Electrostatic Protection.....	28
7 Structural Specification.....	29
7.1 Structural Dimensions.....	29
7.2 Storage .....	30
7.3 Packaging .....	30

8 Appendix Abbreviations .....31

Fibocom Auto Inc.

# 1 Foreword

---

## 1.1 Introduction

This document describes information on electrical characteristics, RF performance, structural dimensions, application environment, and others of the AW916-GL series module. With the help of this document and other related documents, the application developer can quickly understand the hardware functions of AW916-GL series module and develop the hardware of the product.

### **FCC Certification Requirements.**

According to the definition of mobile and fixed device is described in Part 2.1091(b), this device is a mobile device. And the following conditions must be met:

1. This Modular Approval is limited to OEM installation for mobile and fixed applications only. The antenna installation and operating configurations of this transmitter, including any applicable source-based time averaging duty factor, antenna gain, and cable loss must satisfy MPE categorical Exclusion Requirements of 2.1091.
2. The EUT is a mobile device; maintain at least a 20 cm separation between the EUT and the user's body and must not transmit simultaneously with any other antenna or transmitter.
3. A label with the following statements must be attached to the host end product: This device contains AW916-GL FCC ID: 2A8RBAW916GL
4. This module must not transmit simultaneously with any other antenna or transmitter
5. The host end product must include a user manual that clearly defines operating requirements and conditions that must be observed to ensure compliance with current FCC RF exposure guidelines.

For portable devices, in addition to the conditions 3 through 6 described above, a separate approval is required to satisfy the SAR requirements of FCC Part 2.1093

If the device is used for other equipment that separate approval is required for all other operating configurations, including portable configurations with respect to 2.1093 and different antenna configurations.

For this device, OEM integrators must be provided with labeling instructions of finished products.

Please refer to KDB784748 D01 v07, section 8. Page 6/7 last two paragraphs:

A certified modular has the option to use a permanently affixed label, or an electronic label. For a permanently affixed label, the module must be labeled with an FCC ID - Section 2.926 (see 2.2 Certification (labeling requirements) above). The OEM manual must provide clear instructions explaining to the OEM the labeling requirements, options and OEM user manual instructions that are required (see next paragraph).

For a host using a certified modular with a standard fixed label, if (1) the module's FCC ID is not visible when installed in the host, or (2) if the host is marketed so that end users do not have straightforward commonly used methods for access to remove the module so that the FCC ID of the module is visible; then an additional permanent label referring to the enclosed module: AW916-GL: "Contains Transmitter Module FCC ID: 2A8RBAW916GL" or "Contains FCC ID: 2A8RBAW916GL"

The host OEM user manual must also contain clear instructions on how end users can find and/or access the module and the FCC ID.

The final host / module combination may also need to be evaluated against the FCC Part 15B criteria for unintentional radiators in order to be properly authorized for operation as a Part 15 digital device.

The user's manual or instruction manual for an intentional or unintentional radiator shall caution the user that changes, or modifications not expressly approved by the party responsible for compliance could void the user's authority to operate the equipment. In cases where the manual is provided only in a form other than paper, such as on a computer disk or over the Internet, the information required by this section may be included in the manual in that alternative form, provided the user can reasonably be expected to have the capability to access information in that form.

This device complies with part 15 of the FCC Rules. Operation is subject to the following two conditions:

- (1) This device may not cause harmful interference, and
- (2) this device must accept any interference received, including interference that may cause undesired operation.

Changes or modifications not expressly approved by the manufacturer could void the user's authority to operate the equipment.

To ensure compliance with all non-transmitter functions the host manufacturer is responsible for ensuring compliance with

the module(s) installed and fully operational. For example, if a host was previously authorized as an unintentional radiator under the Supplier's Declaration of Conformity procedure without a transmitter certified module and a module is added, the host manufacturer is responsible for ensuring that after the module is installed and operational the host continues to be compliant with the Part 15B unintentional radiator requirements.

### Manual Information to the End User

The OEM integrator has to be aware not to provide information to the end user regarding how to install or remove this RF module in the user's manual of the end product which integrates this module. The end user manual shall include all required regulatory information/warning as shown in this manual.

## IC Statement

### IRSS-GEN

"This device complies with Industry Canada's licence-exempt RSSs. Operation is subject to the following two conditions: (1) This device may not cause interference; and (2) This device must accept any interference, including interference that may cause undesired operation of the device." or "Le présent appareil est conforme aux CNR d'Industrie Canada applicables aux appareils radio exempts de licence. L'exploitation est autorisée aux deux conditions suivantes:

1) l'appareil ne doit pas produire de brouillage; 2) l'utilisateur de l'appareil doit accepter tout brouillage radioélectrique subi, même si le brouillage est susceptible d'en compromettre le fonctionnement."

Déclaration sur l'exposition aux rayonnements RF

L'autre utilisé pour l'émetteur doit être installé pour fournir une distance de séparation d'au moins 20 cm de toutes les personnes et ne doit pas être colocalisé ou fonctionner conjointement avec une autre antenne ou un autre émetteur.

The host product shall be properly labeled to identify the modules within the host product.

The Innovation, Science and Economic Development Canada certification label of a module shall be clearly visible at all times when installed in the host product; otherwise, the host product must be labeled to display the Innovation, Science and Economic Development Canada certification number for the module, preceded by the word "Contains" or similar wording expressing the same meaning, as follows:

AW916-GL: "Contains IC: 29662-AW916GL" or "where: 29662-AW916GL is the module's certification number"

Le produit hôte doit être correctement étiqueté pour identifier les modules dans le produit hôte.

L'étiquette de certification d'Innovation, Sciences et Développement économique Canada d'un module doit être clairement visible en tout temps lorsqu'il est installé dans le produit hôte; sinon, le produit hôte doit porter une étiquette indiquant le numéro de certification d'Innovation, Sciences et Développement économique Canada pour le module, précédé du mot «Contient» ou d'un libellé semblable exprimant la même signification, comme suit:

AW916-GL: "Contient IC: 29662-AW916GL" ou "où: 29662-AW916GL est le numéro de certification du module".

i. the device for operation in the band 5150–5250 MHz is only for indoor use to reduce the potential for harmful interference to co-channel mobile satellite systems;Footnote4







ii. for devices with detachable antenna(s), the maximum antenna gain permitted for devices in the bands 5250-5350 MHz and 5470-5725 MHz shall be such that the equipment still complies with the e.i.r.p. limit;

iii. for devices with detachable antenna(s), the maximum antenna gain permitted for devices in the band 5725-5850 MHz shall be such that the equipment still complies with the e.i.r.p. limits as appropriate;

iv. and where applicable, antenna type(s), antenna model(s), and worst-case tilt angle(s) necessary to remain compliant with the e.i.r.p. elevation mask requirement set forth in section 6.2.2.3 shall be clearly indicated.

## 1.2 Safety Instruction

By following the safety guidelines below, you can ensure your personal safety and help protect the product and work environment from potential damage. Product manufacturers need to communicate the following safety instructions to end users. If these safety principles are not followed, Fibocom Auto Inc. will not be responsible for the consequences caused by incorrect use of users.

	<p>Road safety first! When you are driving, do not use handheld mobile terminal, even if it has a hands-free function. Please stop and then call!</p>
	<p>Please turn off the mobile terminal before boarding. The wireless feature of the mobile device is not allowed on the aircraft to prevent interference with the aircraft communication system. Ignoring this note may result in flight safety issue or even violate the law.</p>
	<p>When in a hospital or health care facility, please be aware of restrictions on the use of mobile terminals. Radio frequency interference may cause medical equipment to malfunction, so it may be necessary to turn off the mobile device.</p>
	<p>The mobile terminal does not guarantee effective connection under any circumstances, for example, when the mobile terminal is defaulted or SIM is invalid. In case of the above situations in an emergency, remember to use the emergency call, and make sure your device is turned on and in an area of sufficient signal strength.</p>
	<p>Your mobile device will receive and transmit RF signals when it is turned on. RF interference occurs when it is near a TV, radio, computer, or other electronic device.</p>
	<p>Keep mobile device away from flammable gases. Turn off the mobile device when you are near to gas stations, oil depots, chemical plants or explosive workplaces. There are potential safety hazards when operating electronic equipment in any potentially explosive area.</p>



## 2 Product Overview

### 2.1 Introduction

AW916-GL series is a WiFi 6 & BT 5.1 module based on QCA6696 kernel with automotive-grade, high-performance, and low-cost. AW916-GL module supports 2x2 MU-MIMO, with a data transmission rate of up to 1201 Mbps. AW916-GL module is used in conjunction with the AN958-AE series module, which is an automotive-grade 5G module developed by Fibocom Auto Inc., to establish reliable 5G+WiFi application solutions.

### 2.2 Main Performance

The following table describes specific performance parameters of AW916-GL module.

**Table 2-1 Main performance parameters of AW916-GL**

Specification/Interface	Indicator
Power supply	Main power supply: 0.95 V/1.35 V/1.95 V Interface voltage: 1.8 V PA power supply voltage: 3.85 V
WLAN protocol	IEEE 802.11a/b/g/n/ac/ax
WiFi specifications	802.11b: 1Mbps, 2Mbps, 5.5Mbps, 11Mbps 802.11g: 6Mbps, 9Mbps, 12Mbps, 18Mbps, 24Mbps, 36Mbps, 48Mbps, 54Mbps 802.11n: MCS0-7 for HT20/40 802.11a: 6Mbps, 9Mbps, 12Mbps, 18Mbps, 24Mbps, 36Mbps, 48Mbps, 54Mbps 802.11ac: MCS0-8 for VHT20, MCS0-9 for 40/80 802.11ax: MCS0-11 for HT20/40/80
WiFi working mode	AP/STA
WiFi modulation and demodulation	BPSK, QPSK, CCK, 16QAM, 64QAM, 256QAM; maximum modem: 1024 QAM
Bluetooth protocol	BT5.1 (BR/EDR+BLE)
Bluetooth modulation and demodulation	GFSK, 8-DPSK, $\pi/4$ -DQPSK
WiFi/BT interface	Power supply/PCIe/ WLAN_EN/ BT_EN/UART/RF antenna interface x2/GPIO/PCM/I2S
Antenna interface	WiFi/BT antenna interface
Physical characteristics	Package dimensions: 23 mm × 23 mm × 2.65 mm
Temperature characteristics	Operating temperature: -40°C to +85°C
RoHS	RoHS compliant

### 2.3 Hardware Block Diagram

The following hardware diagram shows the main hardware functions of the AW916-GL module, including:

- Antenna
- RF Front End

- Wireless transceiver
- Peripheral interface

Figure 2-1 Hardware block diagram

ANT1: WIFI 2.4G(2.4~2.4835GHz)、WIFI 5G(5.15~5.35GHz&5.47~5.85GHz)

ANT0: BT(2.402~2.480GHz)、WIFI 2.4G(2.4~2.4835GHz)、WIFI 5G(5.15~5.35GHz&5.47~5.85GHz)

ANT2: Test PCB RF reservation, not connected to module temporarily

# 3 Application Interfaces

## 3.1 Overview

The AW916-GL module contains 112 LGA pads that can be used directly for platform development.

- Power supply interface
- PCIe interface for WLAN
- UART interface for Bluetooth
- PCM interface for Audio
- WLAN/LTE co-existence interface
- Antenna interface

## 3.2 Pin Distribution

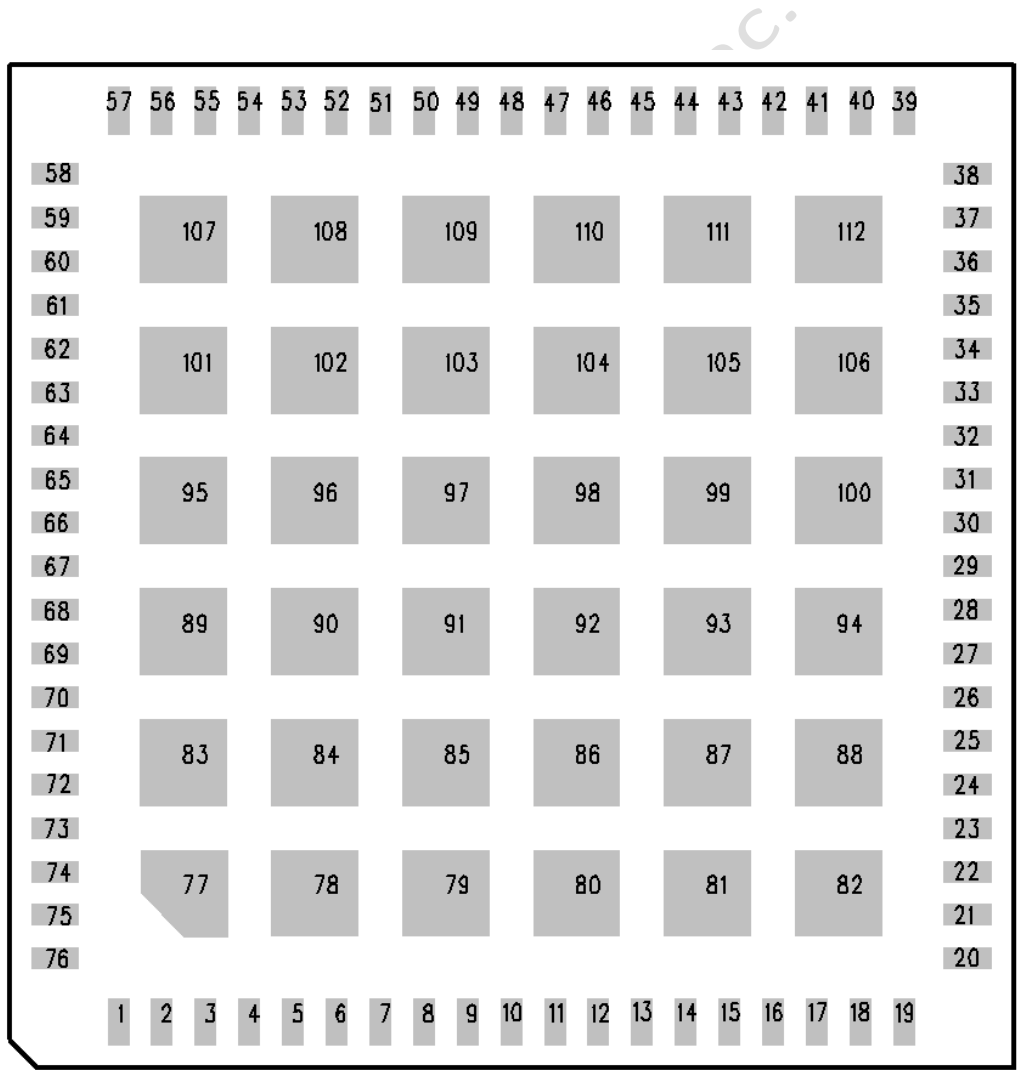

Figure 3-1 Pin distribution (Top perspective)

## 3.3 Pin Definition

**Table 3-1 IO parameter definitions**

Type	Description
IO	Input/Output
DI	Digital input
DO	Digital output
PI	Power input
PO	Power output
AI	Analog input
AO	Analog output
OD	Open drain
NP	No pull-up or pull-down
Hi-Z	High resistance

**Table 3-2 Pin description**

Pin Name	Pin No.	IO	Reset Value	Description	Type
LTE_UART_RXD	1	DI	NP	LTE coexistence UART RXD	--
PCM_IN/I2S_SD_IN	2	DI	NP	Bluetooth PCM input signal/BT I2S Serial Data Input 0 for audio	BT
PCM_OUT/I2S_SD_OUT	3	DO	PU	Bluetooth PCM output signal/BT I2S Serial Data Output 0 for audio	BT
PCM_CLK/I2S_SCK	4	IO	NP	Bluetooth PCM clock signal/BT I2S Continuous Serial Clock 0 for audio	BT
PCM_SYNC/I2S_WS	5	IO	PD	Bluetooth PCM synchronization signal/BT I2S Word Select 0 for audio	BT
GND	6	--	--	--	--
PCIE_RST	7	DI	PD	WLAN PCI express reset with weak pull-down	WiFi
PCIE_WAKE	8	DO	PU	WLAN PCI express request to service a function-initiated wake event. 10k pull-up resistor is required.	WiFi
PCIE_CLKREQ	9	DO	PU	WLAN PCI express reference clock request. 10k pull-up resistor is required.	WiFi
WL_SW_CTRL	10	DO	PD	Signal to control when to turn on power for system	--
GND	11	--	PD	--	--
PCIE_RX_P	12	DI	--	WLAN PCI express differential receive	WiFi
PCIE_RX_N	13	DI	--	WLAN PCI express differential receive	WiFi
GND	14	--	--	--	--
PCIE_TX_P	15	DO	--	WLAN PCI express differential transmit	WiFi
PCIE_TX_N	16	DO	--	WLAN PCI express differential transmit	WiFi
GND	17	--	--	--	--

Pin Name	Pin No.	IO	Reset Value	Description	Type
PCIE_CLK_N	18	DI	--	WLAN PCI express differential reference clock	WiFi
PCIE_CLK_P	19	DI	--	WLAN PCI express differential reference clock	WiFi
WL_DB_UART_RXD	20	DI	NP	WLAN Debug UART Receive	WiFi
WL_DB_UART_TXD	21	DO	NP	WLAN Debug UART Transmit	WiFi
SLEEP_CLK	22	AI	NP	External low-power 32.768 kHz clock input.	--
GND	23	--	--	--	--
NC	24	--	--	--	--
NC	25	--	--	--	--
GND	26	--	--	--	--
NC	27	--	--	--	--
NC	28	--	--	--	--
GND	29	--	--	--	--
JTAG_TDO	30	DO	--	JTAG Test Data output	--
JTAG_TDI	31	DI	--	JTAG Test Data input	--
JTAG_TCK	32	DI	--	JTAG Test Clock	--
JTAG_TRST	33	DI	--	JTAG Test Reset	--
JTAG_TMS	34	DI	--	JTAG Test Mode Select	--
NC	35	--	--	--	--
GND	36	--	--	--	--
BT_RF	37	--	--	BT_ANT	--
GND	38	--	--	--	--
NC	39	--	--	--	--
NC	40	--	--	--	--
NC	41	--	--	--	--
NC	42	--	--	--	--
GND	43	--	--	--	--
GND	44	--	--	--	--
WL_RF0	45	IO	--	WiFi0_ANT	-
GND	46	--	--	--	--
GND	47	--	--	--	--
NC	48	--	--	--	--
NC	49	--	--	--	--
NC	50	--	--	--	--
NC	51	--	--	--	--
GND	52	--	--	--	--
GND	53	--	--	--	--
WL_RF1	54	IO	--	WiFi1_ANT	-
GND	55	--	--	--	--

Pin Name	Pin No.	IO	Reset Value	Description	Type
GND	56	--	--	--	--
NC	57	--	--	--	--
GPIO_8	58	DO	PD	BT sensor UART TXD	BT
GPIO_13	59	DI	NP	I2C clock	--
GPIO_12	60	IO	NP	I2C data	--
GPIO_9	61	DI	PU	BT sensor UART RXD	BT
NC	62	--	--	--	--
NC	63	--	--	--	--
NC	64	--	--	--	--
NC	65	--	--	--	--
NC	66	--	--	--	--
GND	67	--	PD	--	--
WL_EN	68	DI	NP	WLAN enable signal	WL
BT_EN	69	DI	NP	Bluetooth enable signal	BT
GND	70	--	--	--	--
VDD18_IO	71	PI	--	1.8V IO supply	--
BT_UART_RTS	72	DO	PU	BT UART Request To Send for HCI messaging	BT
BT_UART_CTS	73	DI	PD	BT UART Clear To Send for HCI messaging	BT
BT_UART_TXD	74	DO	PD	BT UART Transmit Data for HCI messaging	BT
BT_UART_RXD	75	DI	PU	BT UART Receive Data for HCI messaging	BT
LTE_UART_TXD	76	DO	PD	LTE coexistence UART TXD	--
VDD_CORE_VH	77	PI	--	Voltage for Core, high voltage (1.95 V supply)	--
GND	78	--	--	--	--
VDD_CORE_VL	79	PI	PD	Voltage for Core, low voltage (0.95 V supply)	--
GND	80	--	--	--	--
GND	81	--	--	--	--
GND	82	--	--	--	--
VDD_CORE_VH	83	PI	PD	Voltage for Core, high voltage (1.95 V supply)	--
GND	84	--	--	--	--
VDD_CORE_VL	85	PI	PD	Voltage for Core, low voltage (0.95 V supply)	--
VDD_CORE_VL	86	PI	PD	Voltage for Core, low voltage (0.95 V supply)	--
GND	87	--	--	--	--
GND	88	--	--	--	--
VDD_CORE_VM	89	PI	--	Voltage for Core, mid voltage (1.35 V supply)	--

Pin Name	Pin No.	IO	Reset Value	Description	Type
GND	90	--	--	--	--
GND	91	--	--	--	--
GND	92	--	--	--	--
GND	93	--	--	--	--
GND	94	--	--	--	--
GND	95	--	--	--	--
GND	96	--	--	--	--
GND	97	--	--	--	--
GND	98	--	--	--	--
GND	99	--	--	--	--
GND	100	--	--	--	--
VDD_PA	101	PI	--	VDD for 5GHz PA	--
VDD_PA	102	PI	--	VDD for 5GHz PA	--
GND	103	--	--	--	--
GND	104	--	--	--	--
VDD_PA	105	PI	--	VDD for 2.4GHz PA	-
VDD_PA	106	PI	--	VDD for 2.4GHz PA	--
GND	107	--	--	--	--
GND	108	--	--	--	--
GND	109	--	--	--	--
GND	110	--	--	--	--
GND	111	--	--	--	--
GND	112	--	--	--	--

### 3.4 Power Supply

The AW916-GL module provides power supply through VDD\_PA, VDD\_PA, VDD\_CORE\_VH, VDD\_CORE\_VM, VDD\_CORE\_VL, and VDD18\_IO pins. The following table describes the power interface of the module.

**Table 3-3 Power supply parameters**

Pin Name	IO	Pin No.	Description	Maximum current
VDD_PA	PI	105, 106	2.4G PA power supply, 3.75–3.95 V, typical value of 3.85 V	1300 mA
VDD_PA	PI	101, 102	5G PA power supply, 3.75–3.95 V, typical value of 3.85 V	
VDD_CORE_VH	PI	77, 83	Kernel high-voltage power supply, 1.85–2.05 V, typical value of 1.95 V	250 mA

Pin Name	IO	Pin No.	Description	Maximum current
VDD_CORE_VM	PI	89	Module medium-voltage power supply, 1.28–1.42 V, typical value of 1.35 V	400 mA
VDD_CORE_VL	PI	79, 85, 86	Kernel low-voltage power supply, 0.9–1 V, typical value of 0.95 V	1200 mA
VDD18_IO	PI	71	I/O voltage power supply, 1.7–1.9 V, typical value of 1.8 V	30 mA
GND	--	--	Ground signal. All ground pins must be grounded.	--

The power input range of AW916-GL module is 3.75–3.95 V, and the recommended value is 3.85 V. The performance of the power supply, such as the load capacity and ripple, will directly affect the performance and stability of the module.

**Table 3-4 Reference capacitance of power supply**

Power Supply Name	Pin No.	Filter Capacitor
VDD_PA	105, 106	47u/22u/220p
VDD_PA	101, 102	47u/22u/220p
VDD_CORE_VH	77, 83	47u/10u/0.1u
VDD_CORE_VM	89	47u/10u/220p
VDD_CORE_VL	79, 85, 86	47u/22u/220p
VDD18_IO	71	47u and 0.1u

## 3.5 Power Supply Time Sequence

The power supply time sequence diagram is shown as follows:



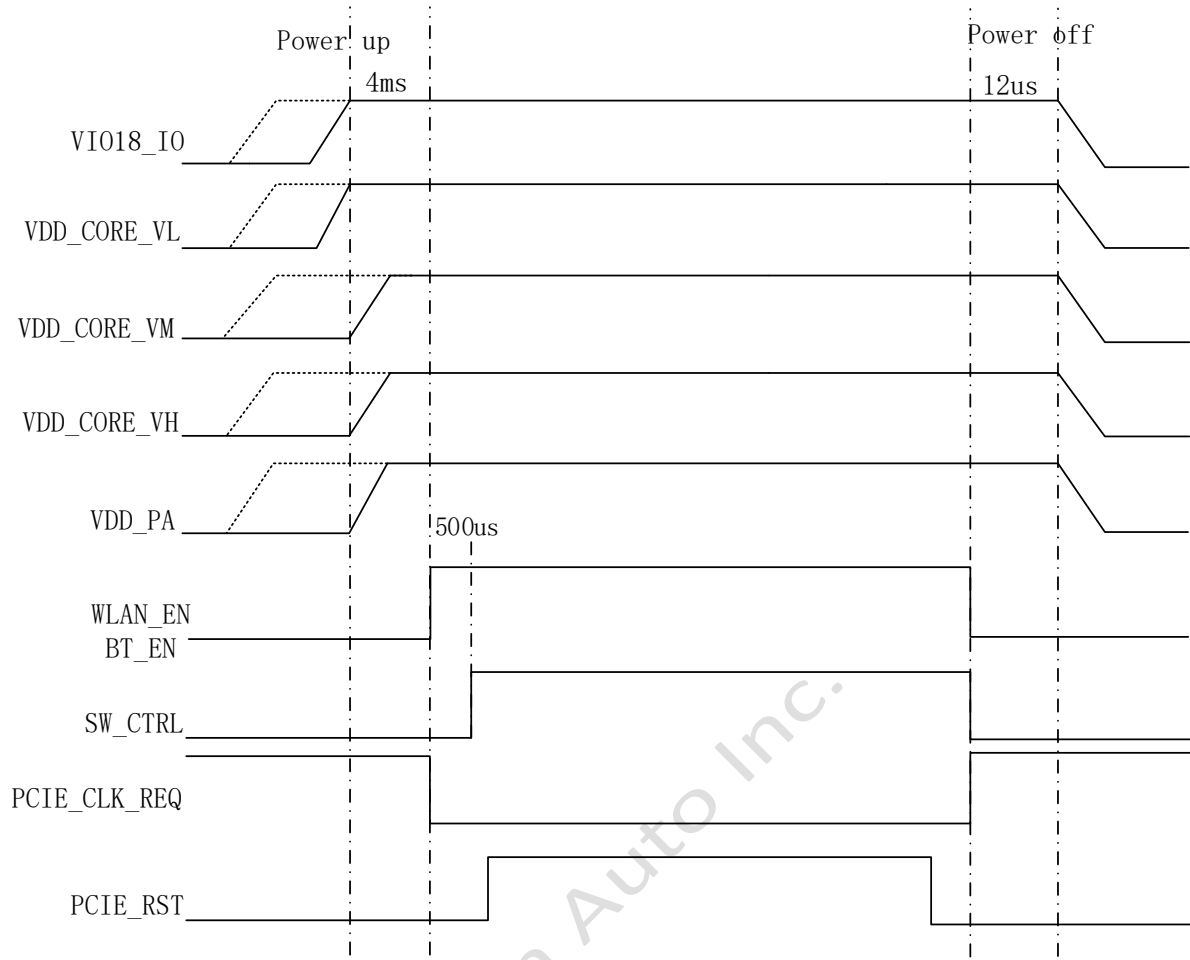

Figure 3-2 Power supply time sequence diagram

**Warning**

1. There is no requirement of time sequence between VIO18\_IO and VDD\_CORE\_VL. Their power up time must be 4 ms ahead of WLAN\_EN/BT\_EN's.
2. There is no requirement of time sequence among VDD\_CORE\_VH, VDD\_CORE\_VM and VDD\_PA. Their power up time must be ahead of WLAN\_EN/BT\_EN's.

### 3.6 Power Consumption

The following table describes the actual measured current data(voltage: 3.8V) of AN958 + AW916-GL for reference.

**Table 3-5 RF power consumption**

WLAN Standard	Data Rate	I <sub>WLAN_3V8</sub>	Unit	Note
802.11b	TX 1Mbps	200	mA	--
	TX 11Mbps	180	mA	
802.11g	TX 6Mbps	120	mA	--
	TX 54Mbps	105	mA	
802.11n	TX HT20-MCS7	110	mA	--
	TX HT40-MCS7	110	mA	

WLAN Standard	Data Rate	I <sub>WLAN_3V8</sub>	Unit	Note
802.11a	TX HT20 MCS7	110	mA	--
802.11ac	TX VHT20-MCS8	90	mA	--
	TX VHT40-MCS9	95	mA	
	TX VHT80-MCS9	100	mA	
802.11ax	TX VHT20-MCS9	95	mA	--
	TX VHT40-MCS11	100	mA	
	TX VHT80-MCS11	105	mA	

## 3.7 PCIe Interface

### 3.7.1 Interface Description

AW916-GL module provides a set of PCIe interfaces. The following table describes the pin definitions.

**Table 3-6 PCIe pin definition**

Pin Name	I/O	Pin No.	Description
PCIE_CLK_N	AIO	18	PCIe reference clock signal(-)
PCIE_CLK_P	AIO	19	PCIe reference clock signal (+)
PCIE_TX_N	AO	16	PCIe data TX channel 0 signal (-)
PCIE_TX_P	AO	15	PCIe data TX channel 0 signal (+)
PCIE_RX_P	AI	12	PCIe data RX channel 0 signal (+)
PCIE_RX_N	AI	13	PCIe data RX channel 0 signal (-)
PCIE_RST	DO	7	PCIe reset signal
PCIE_WAKE	DO	8	PCIe wakeup signal
PCIE_CLKREQ	DO	9	PCIe clock request signal

### 3.7.2 PCIe Wiring Rules

- 1) The differential impedance is 85 Ω.
- 2) Each pair of differential wires shall be isolated by ground wire properly, keep 4 times the line width spacing, and fully cover with ground vias.
- 3) The maximum wiring length of PCIe is 280 mm, which shall be as short as possible.
- 4) P/N wiring length are equal, the difference is controlled within 0.7mm.

## 4 Antenna Interface

---

The AW916-GL module adopts the 2×2 MIMO antenna scheme. The following describes the information of each antenna.

### 4.1 RF Antenna Interface Configuration

The AW916-GL module provides two WiFi antenna interfaces that supports both 2.4 GHz and 5 GHz. The following table describes the definitions of antenna interface pins.

**Table 4-1 Definitions of antenna interface pins**

Pin Name	Pin	Description	IO	Remarks
WiFi0/BT_ANT	45	WiFi0 antenna interface	IO	50 Ω impedance
WiFi1_ANT	54	WiFi1 antenna interface	IO	50 Ω impedance

### 4.2 Operating Bands

**Table 4-2 Operating bands of the module**

Band	Frequency	Unit
2.4 GHz WLAN	2402–2483.5	MHz
5 GHz WLAN	5150–5350 5470–5850	MHz
BT	2402–2480	MHz

### 4.3 Reference Design

The AW916-GL module provides BT antenna interface and WiFi antenna interface. Microstrip lines shall be used for PCB wiring between the RF antenna and the module. The impedance shall be controlled at 50 Ω. The resistor and capacitor shall be adjusted according to the RF parameters. The following figure shows the reference design.

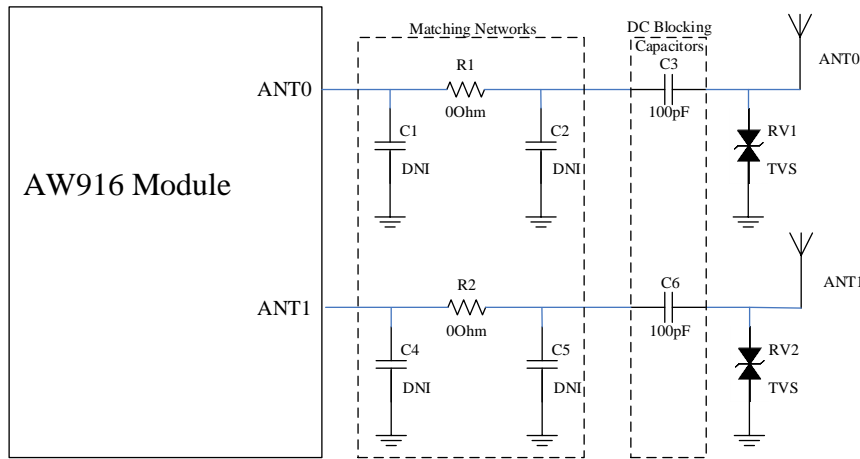

Figure 4-1 Reference design of WiFi/BT antenna interface

ANT1: WIFI 2.4G(2.4~2.4835GHz)、WIFI 5G(5.15~5.35GHz&5.47~5.85GHz)

ANT0: BT(2.402~2.480GHz)、WIFI 2.4G(2.4~2.4835GHz)、WIFI 5G(5.15~5.35GHz&5.47~5.85GHz)

### Reference Design of RF Layout

For user's PCB, the characteristic impedance of all RF traces should be controlled as 50Ω. The impedance of the RF traces is usually determined by the trace width (W), the materials' dielectric constant, height from the reference ground to the signal layer (H), and the space between the RF trace and the ground (S). Microstrip and coplanar waveguide are typically used in RF layout to control characteristic impedance. The following figures are reference designs of microstrip or coplanar waveguide with different PCB structures.

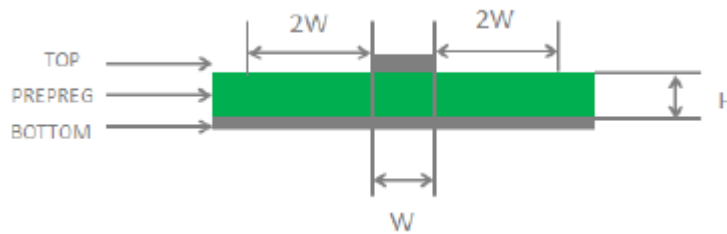

Microstrip Design on a 2-layer PCB

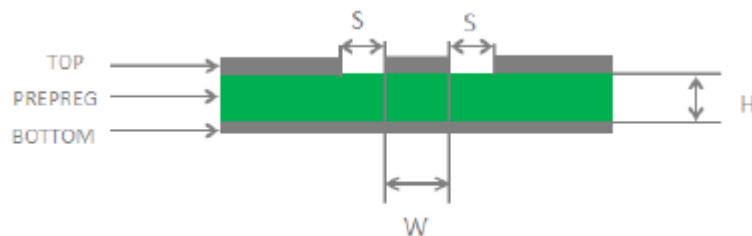

Coplanar Waveguide Design on a 2-layer PCB

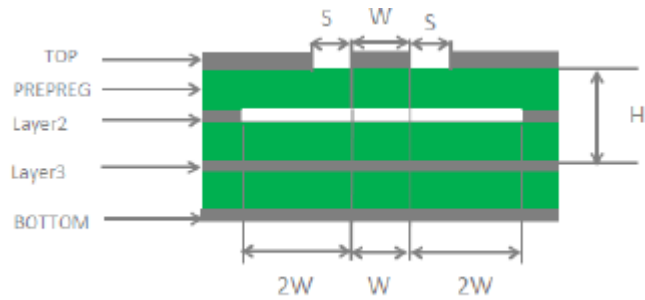

### Coplanar Waveguide Design on a 4-layer PCB (Layer 3 as Reference Ground)

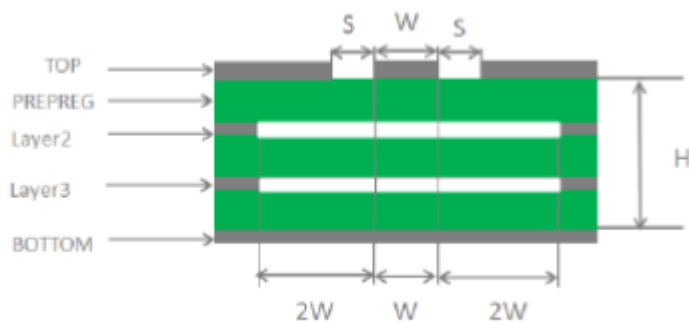

### Coplanar Waveguide Design on a 4-layer PCB (Layer 4 as Reference Ground)

To ensure RF performance and reliability, the following principles should be complied with in RF layout design:

- Use an impedance simulation tool to control the characteristic impedance of RF traces as  $50\Omega$ .
- The GND pins adjacent to RF pins should be designed as thermal relief pads, and should be fully connected to ground.
- The distance between the RF pins and the RF connector should be as short as possible, and all the right-angle traces should be changed to curved ones.
- There should be clearance area under the signal pin of the antenna connector or solder joint.
- The reference ground of RF traces should be complete. Meanwhile, adding some ground vias around RF traces and the reference ground could help to improve RF performance. The distance between the ground vias and RF traces should be no less than two times the width of RF signal traces ( $2*W$ ).

### Recommended RF Connector for Antenna Installation

If RF connector is used for antenna connection, it is recommended to use U.FL-R-SMT connector provided by Hirose

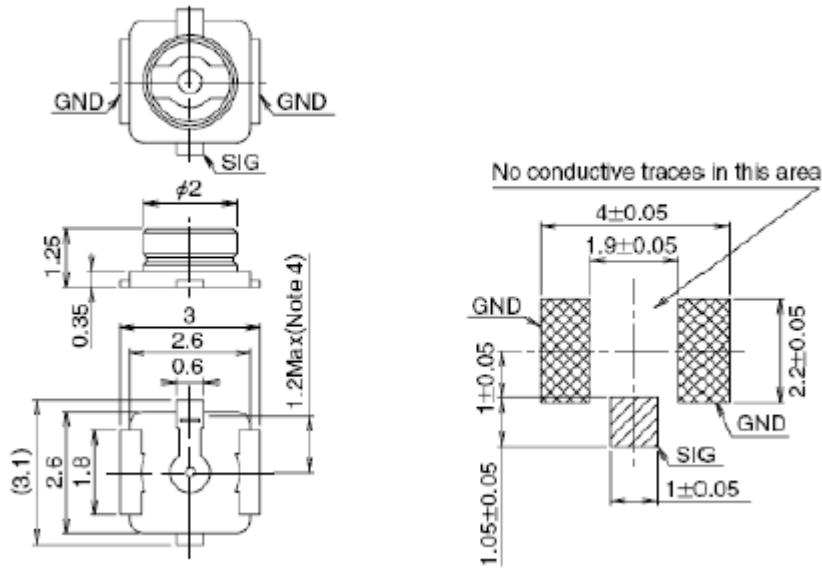

**Dimensions of the U.FL-R-SMT Connector (Unit: mm)**

U.FL-LP serial connectors listed in the following figure can be used to match the U.FL-R-SMT.

	U.FL-LP-040	U.FL-LP-066	U.FL-LP(V)-040	U.FL-LP-062	U.FL-LP-088
Part No.					
Mated Height	2.5mm Max. (2.4mm Nom.)	2.5mm Max. (2.4mm Nom.)	2.0mm Max. (1.9mm Nom.)	2.4mm Max. (2.3mm Nom.)	2.4mm Max. (2.3mm Nom.)
Applicable cable	Dia. 0.81mm Coaxial cable	Dia. 1.13mm and Dia. 1.32mm Coaxial cable	Dia. 0.81mm Coaxial cable	Dia. 1mm Coaxial cable	Dia. 1.37mm Coaxial cable
Weight (mg)	53.7	59.1	34.8	45.5	71.7
RoHS	YES				

**Mechanicals of U.FL-LP Connectors**

The following figure describes the space factor of mated connector.

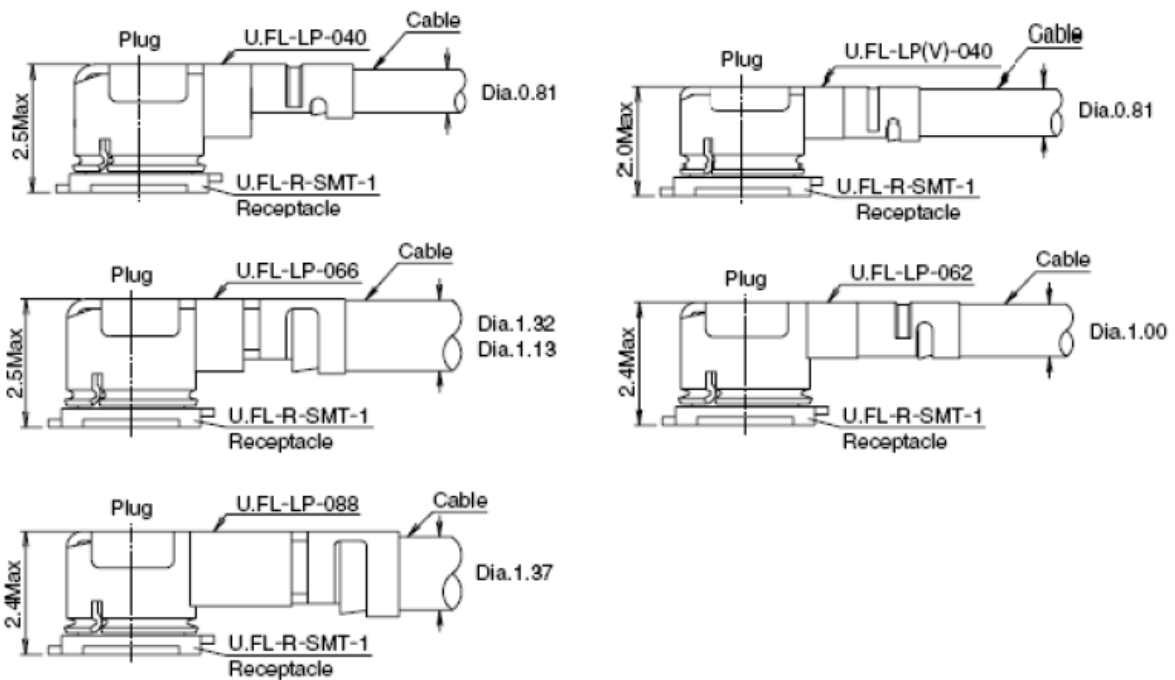

Space Factor of Mated Connector (Unit: mm)

## 4.4 Antenna Specification Requirements

The AW916-GL module provides two WiFi transceiver antenna interfaces. The following table describes the antenna requirements.

Table 4-3 Antenna requirements of the module

Specifications	Parameter
Frequency Range	2402 MHz to 2483.5 MHz 5150 MHz to 5850 MHz
VSWR	VSWR < 2:1
Antenna Efficiency	>30%
Max Output Power (W)	2 W
Input Impedance ( $\Omega$ )	50
Cable Insertion Loss	<1.5 dB (2402 MHz to 2483.5 MHz) <2 dB (5150 MHz to 5850 MHz)
Polarization Type	Vertical
Antenna type	Dipole antenna/ PCB Antenna
MAX Antenna size	25cm*5cm*3cm

Recommended Antenna Gain (dBi):

Frequency Range	MAX Gain dBi
-----------------	--------------

2.4~2.4835 GHz	2.82
5.15~5.25 GHz	2.05
5.25~5.35 GHz	2.35
5.47~5.725 GHz	4.21
5.725~5.85 GHz	3.97

Fibocom Auto Inc.



# 5 Electrical Characteristics and Reliability

## 5.1 Electrical Characteristics

**Table 5-1 Reference electrical characteristics**

Parameter	Min	Nominal	Max	Unit	Note
VOL	0	--	0.45	V	Low level of IO interface
VOH	1.35	--	1.8	V	High level of IO interface
Operating Temperature	-40	25	85	°C	--
Storage Temperature	-40	25	95	°C	--

## 5.2 WiFi Performance Indicators

Test condition: Power supply at 3.8 V and ambient temperature at 25°C.

**Table 5-2 2.4 GHz conduction output power**

Standard	Data Rate	ANT 0/ANT1 Typ.	Unit	Note
802.11b	1 Mbps	16±2.5	dBm	--
802.11b	11 Mbps	16±2.5	dBm	--
802.11g	6 Mbps	16±2.5	dBm	--
802.11g	54 Mbps	16±2.5	dBm	--
802.11n, HT20	MCS0	16±2.5	dBm	--
802.11n, HT20	MCS7	15.5±2.5	dBm	--
802.11n, HT40	MCS0	16±2.5	dBm	--
802.11n, HT40	MCS7	15±2.5	dBm	--
802.11ax, HT20	MCS0	16±2.5	dBm	--
802.11ax, HT20	MCS11	14±2.5	dBm	--
802.11ax, HT40	MCS0	16±2.5	dBm	--
802.11ax, HT40	MCS11	13.5±2.5	dBm	--

**Table 5-3 5 GHz conduction output power**

Standard	Data Rate	ANT 0/ANT1 Typ.	Unit	Note
802.11a	6 Mbps	16±2.5	dBm	--
802.11a	54 Mbps	15±2.5	dBm	--
802.11n, HT20	MCS0	16±2.5	dBm	--
802.11n, HT20	MCS7	14±2.5	dBm	--
802.11n, HT40	MCS0	16±2.5	dBm	--
802.11n, HT40	MCS7	13.5±2.5	dBm	--

Standard	Data Rate	ANT 0/ANT1 Typ.	Unit	Note
802.11ac, HT20	MCS0	16±2.5	dBm	--
802.11ac, HT20	MCS8	13.5±2.5	dBm	--
802.11ac, HT40	MCS0	16±2.5	dBm	--
802.11ac, HT40	MCS9	13±2.5	dBm	--
802.11ac, HT80	MCS0	16±2.5	dBm	--
802.11ac, HT80	MCS9	12.5±2.5	dBm	--
802.11ax, HT20	MCS0	16±2.5	dBm	--
802.11ax, HT20	MCS11	12±2.5	dBm	--
802.11ax, HT40	MCS0	16±2.5	dBm	--
802.11ax, HT40	MCS11	11.5±2.5	dBm	--
802.11ax, HT80	MCS0	16±2.5	dBm	--
802.11ax, HT80	MCS11	11±2.5	dBm	--

**Table 5-4 2.4 GHz RX sensitivity**

Standard	Data Rate	ANT 0/ANT1 Typ.	Unit	Note
802.11b	1 Mbps	-93	dBm	--
802.11b	11 Mbps	-88	dBm	--
802.11g	6 Mbps	-86	dBm	--
802.11g	54 Mbps	-76	dBm	--
802.11n, HT20	MCS0	-88	dBm	--
802.11n, HT20	MCS7	-70	dBm	--
802.11n, HT40	MCS0	-85	dBm	--
802.11n, HT40	MCS7	-68	dBm	--
802.11ax, HT20	MCS0	-90	dBm	--
802.11ax, HT20	MCS11	-62	dBm	--
802.11ax, HT40	MCS0	-88	dBm	--
802.11ax, HT40	MCS11	-61	dBm	--

**Table 5-5 5 GHz RX sensitivity**

Standard	Data Rate	ANT 0/ANT 1 Typ.	Unit	Note
802.11a	6 Mbps	-92	dBm	--
802.11a	54 Mbps	-76	dBm	--
802.11n, HT20	MCS0	-90	dBm	--
802.11n, HT20	MCS7	-71	dBm	--
802.11n, HT40	MCS0	-88	dBm	--
802.11n, HT40	MCS7	-68	dBm	--
802.11ac, HT20	MCS0	-90	dBm	--
802.11ac, HT20	MCS8	-70	dBm	--
802.11ac, HT40	MCS0	-88	dBm	--

Standard	Data Rate	ANT 0/ANT 1 Typ.	Unit	Note
802.11ac, HT40	MCS9	-65	dBm	--
802.11ac, HT80	MCS0	-86	dBm	--
802.11ac, HT80	MCS9	-63	dBm	--
802.11ax, HT20	MCS0	-92	dBm	--
802.11ax, HT20	MCS11	-62	dBm	--
802.11ax, HT40	MCS0	-90	dBm	--
802.11ax, HT40	MCS11	-61	dBm	--
802.11ax, HT80	MCS0	-87	dBm	--
802.11ax, HT80	MCS11	-58	dBm	--

## 5.3 BT Performance Indicators

Test condition: Power supply at 3.8 V and ambient temperature at 25°C.

**Table 5-6 BT performance indicators**

Type	DH-5	2-DH5	3-DH5	Unit
Transmitter	11±1	10±1	10±1	dBm
Sensitivity	-94	-93	-90	dBm

## 6 Electrostatic Protection

---

In the application of the module, static electricity is generated by human body and friction between micro-electronics. The static electricity is discharged to the module through various channels and may cause damage to the module. Therefore, ESD protection shall be taken seriously.

In the process of R&D, production assembly and testing, especially in product design, ESD protection measures shall be taken. For example, ESD protection shall be applied at the designed circuit interfaces and at the points susceptible to electrostatic discharge or impact. Anti-static gloves shall be worn during production.

The following table lists the ESD performance parameters (temperature: 25°C, humidity: 45%).

**Table 6-1 ESD performance**

Test Point	Contact Discharge	Air Discharge	Unit
GND	TBD	TBD	kV
Antenna Interface	TBD	TBD	kV
Other interfaces	TBD	TBD	kV

# 7 Structural Specification

## 7.1 Structural Dimensions

The following figure shows the structural dimension of the AW916-GL module.

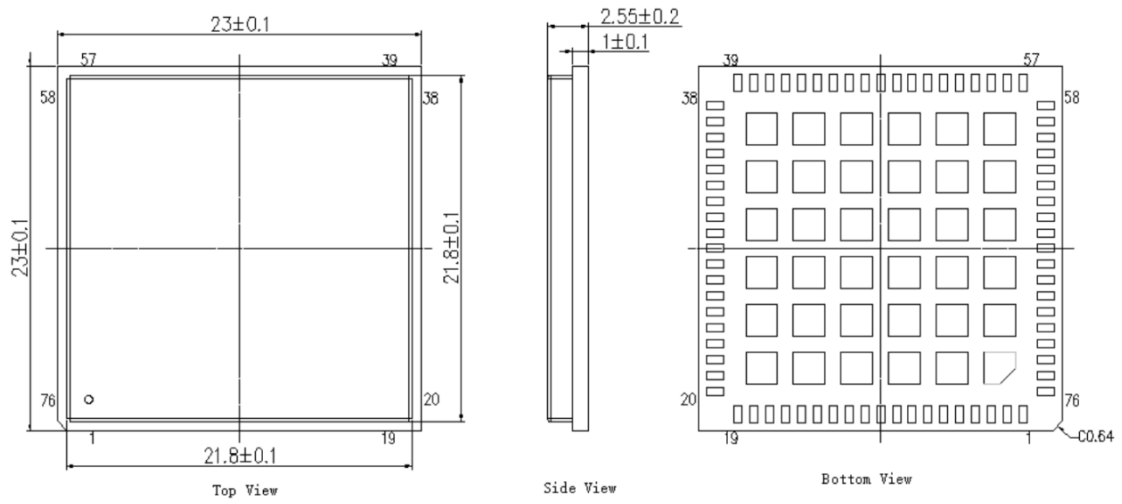

Figure 7-3 Structural dimensions (combined diagram in third angle projection)

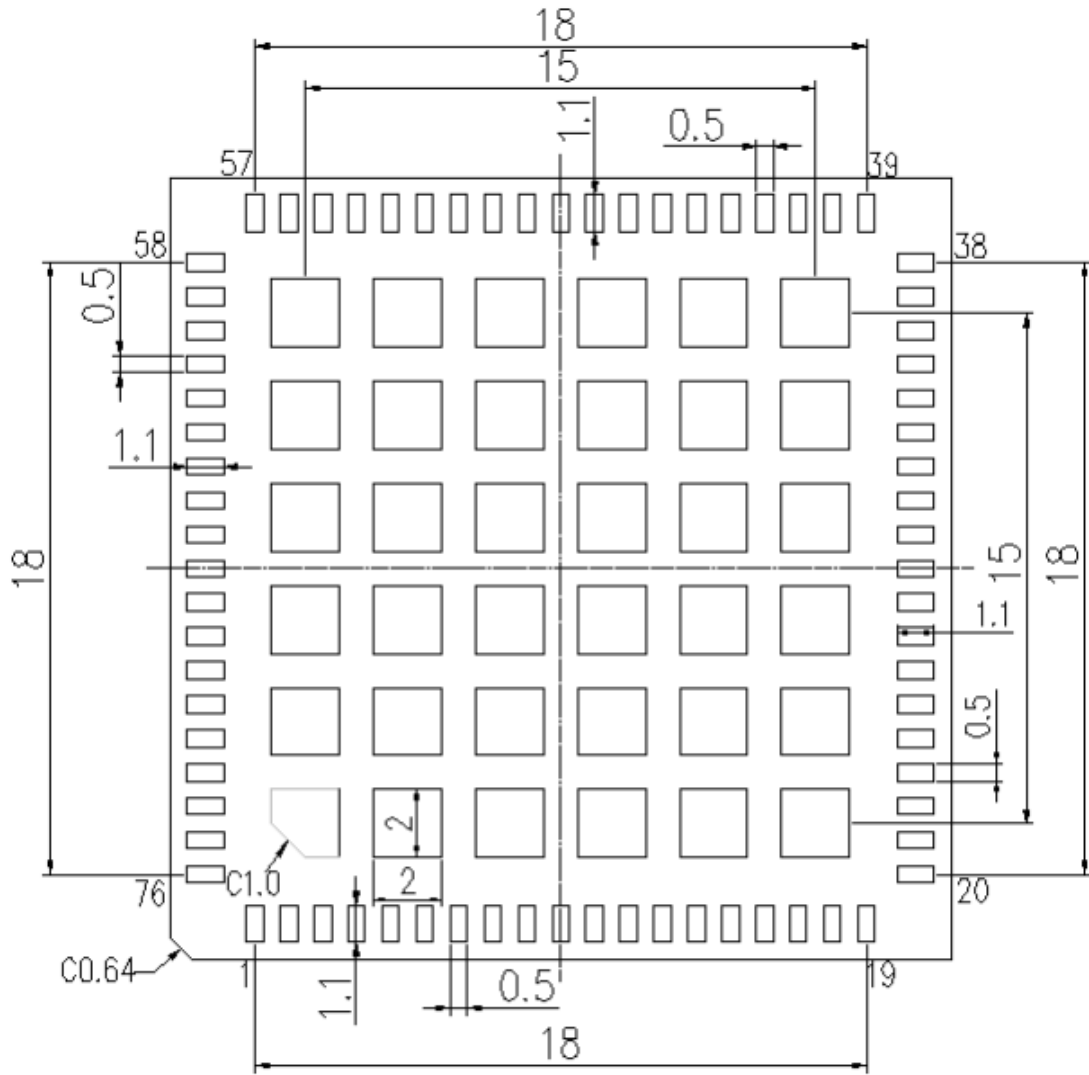

Figure 7-4 Front perspective view

**i** Note

- 1) Unmarked dimensional tolerances are  $\pm 0.1$  mm.

## 7.2 Storage

See *FIBOCOM AW916-GL SMT Design Guide*.

## 7.3 Packaging

See *FIBOCOM AW916-GL SMT Design Guide*.

## 8 Appendix Abbreviations

Term	Description
AP	Access Point
BPSK	Binary Phase Shift Keying
CCK	Complementary Code Keying
CTS	Clear To Send
ESD	Electrostatic Discharge
GND	Ground
HT	High Throughput
IEEE	Institute of Electrical and Electronics Engineers
$I_{IL}$	Input Leakage Current
I/O	Input/Output
LTE	Long Term Evolution
Mbps	Million Bits Per Second
MCS	Modulation and Coding Scheme
MOQ	Minimum Order Quantity
MP	Manufacture Product
PCB	Printed Circuit Board
QAM	Quadrature Amplitude Modulation
QPSK	Quadrature Phase Shift Keying
RF	Radio Frequency
RH	Relative Humidity
RoHS	Restriction of Hazardous Substances
RX	Receive Direction
SDIO	Secure Digital Input and Output Card
TBD	To Be Determined
TX	Transmitting Direction
USB	Universal Serial Bus
VDD	Voltage Power for Digital Device
VHT	Very High Throughput
$V_{IHmax}$	Maximum Input High Level Voltage Value
$V_{IHmin}$	Minimum Input High Level Voltage Value
$V_{ILmax}$	Maximum Input Low Level Voltage Value
$V_{ILmin}$	Minimum Input Low Level Voltage Value
VIO	Voltage for Input/Output Port
$V_{OLmax}$	Maximum Output Low Level Voltage Value
$V_{OHmin}$	Minimum Output High Level Voltage Value
VSWR	Voltage Standing Wave Ratio

Term	Description
WiFi	Wireless-Fidelity
WLAN	Wireless Local Area Networks

### Federal Communication Commission Interference Statement

This device complies with Part 15 of the FCC Rules. Operation is subject to the following two conditions: (1) This device may not cause harmful interference, and (2) this device must accept any interference received, including interference that may cause undesired operation.

This equipment has been tested and found to comply with the limits for a Class B digital device, pursuant to Part 15 of the FCC Rules. These limits are designed to provide reasonable protection against harmful interference in a residential installation. This equipment generates, uses and can radiate radio frequency energy and, if not installed and used in accordance with the instructions, may cause harmful interference to radio communications. However, there is no guarantee that interference will not occur in a particular installation. If this equipment does cause harmful interference to radio or television reception, which can be determined by turning the equipment off and on, the user is encouraged to try to correct the interference by one of the following measures:

- Reorient or relocate the receiving antenna.
- Increase the separation between the equipment and receiver.
- Connect the equipment into an outlet on a circuit different from that to which the receiver is connected.
- Consult the dealer or an experienced radio/TV technician for help.

### FCC Caution:

- Any changes or modifications not expressly approved by the party responsible for compliance could void the user's authority to operate this equipment.
- This transmitter must not be co-located or operating in conjunction with any other antenna or transmitter.

### Radiation Exposure Statement:

This equipment complies with FCC radiation exposure limits set forth for an uncontrolled environment. This equipment should be installed and operated with minimum distance 20cm between the radiator & your body.

### IC Statement

#### IRSS-GEN

"This device complies with Industry Canada's licence-exempt RSSs. Operation is subject to the following two conditions: (1) This device may not cause interference; and (2) This device must accept any interference, including interference that may cause undesired operation of the device." or "Le présent appareil est conforme aux CNR d'Industrie Canada applicables aux appareils radio exempts de licence. L'exploitation est autorisée aux deux conditions suivantes:

1) l'appareil ne doit pas produire de brouillage; 2) l'utilisateur de l'appareil doit accepter tout brouillage radioélectrique subi, même si le brouillage est susceptible d'en compromettre le fonctionnement."

#### Déclaration sur l'exposition aux rayonnements RF

L'autre utilisé pour l'émetteur doit être installé pour fournir une distance de séparation d'au moins 20 cm de toutes les



personnes et ne doit pas être colocalisé ou fonctionner conjointement avec une autre antenne ou un autre émetteur.

The host product shall be properly labeled to identify the modules within the host product.

The Innovation, Science and Economic Development Canada certification label of a module shall be clearly visible at all times when installed in the host product; otherwise, the host product must be labeled to display the Innovation, Science and Economic Development Canada certification number for the module, preceded by the word “Contains” or similar wording expressing the same meaning, as follows:

“Contains IC: 10224A-22SC262RNA” or “where: 10224A-22SC262RNA is the module’s certification number”.

Le produit hôte doit être correctement étiqueté pour identifier les modules dans le produit hôte.

L'étiquette de certification d'Innovation, Sciences et Développement économique Canada d'un module doit être clairement visible en tout temps lorsqu'il est installé dans le produit hôte; sinon, le produit hôte doit porter une étiquette indiquant le numéro de certification d'Innovation, Sciences et Développement économique Canada pour le module, précédé du mot «Contient» ou d'un libellé semblable exprimant la même signification, comme suit:

"Contient IC: 10224A-22SC262RNA " ou "où: 10224A-22SC262RNA est le numéro de certification du module".

- i. the device for operation in the band 5150–5250 MHz is only for indoor use to reduce the potential for harmful interference to co-channel mobile satellite systems;
- ii. for devices with detachable antenna(s), the maximum antenna gain permitted for devices in the bands 5250-5350 MHz and 5470-5725 MHz shall be such that the equipment still complies with the e.i.r.p. limit;
- iii. for devices with detachable antenna(s), the maximum antenna gain permitted for devices in the band 5725-5850 MHz shall be such that the equipment still complies with the e.i.r.p. limits as appropriate;
- iv. Omnidirectional antenna is recommended