

# FCC SAR EVALUATION REPORT

**In accordance with the requirements of  
FCC 47 CFR Part 2(2.1093) and  
IEEE Std 1528-2013**

**Product Name :** Smart phone

**Brand Name :** Blackview

**Model Name :** BV7300

**Family Model :** N/A

**Report No. :** S24091001706001

**FCC ID :** 2A7DX-BV7300

**Prepared for**

**DOKE COMMUNICATION (HK) LIMITED**

**19H MAXGRAND PLAZA NO 3 TAI YAU STREET SAN PO KONG KL**

**Prepared by**

**Shenzhen NTEK Testing Technology Co., Ltd.**

**1/F, Building E, Fenda Science Park, Sanwei Community,  
Xixiang Street Bao'an District, Shenzhen 518126 P.R. China**

**Tel. 400-800-6106, 0755-2320 0050, 0755-2320 0090**

**Website: <http://www.ntek.org.cn>**

## TEST RESULT CERTIFICATION

**Applicant's name** ..... DOKE COMMUNICATION (HK) LIMITED  
 Address..... 19H MAXGRAND PLAZA NO 3 TAI YAU STREET SAN PO  
 KONG KL

**Manufacturer's Name** . Shenzhen DOKE Electronic Co., Ltd  
 Address..... 801, Building3, 7th Industrial Zone, Yulv Community, Yutang Road,  
 Guangming District, Shenzhen, China.

**Product description**

Product name ..... Smart phone  
 Brand Name ..... Blackview  
 Model and/or type ..... BV7300  
 reference .....  
 Family Model ..... NA  
 FCC 47 CFR Part 2(2.1093)

**Standards** ..... IEEE Std 1528-2013  
 Published RF exposure KDB procedures

This device described above has been tested by Shenzhen NTEK. In accordance with the measurement methods and procedures specified in IEEE Std 1528-2013 and KDB 865664 D01. Testing has shown that this device is capable of compliance with localized specific absorption rate (SAR) specified in FCC 47 CFR Part 2(2.1093). The test results in this report apply only to the tested sample of the stated device/equipment. Other similar device/equipment will not necessarily produce the same results due to production tolerance and measurement uncertainties.

This report shall not be reproduced except in full, without the written approval of Shenzhen NTEK, this document may be altered or revised by Shenzhen NTEK, personal only, and shall be noted in the revision of the document.

Test Sample Number ..... S240910017007

**Date of Test**

Date (s) of performance of tests... Sep. 13, 2024~ Oct. 13, 2024  
 Date of Issue ..... Oct.23, 2024  
 Test Result ..... **Pass**

Prepared By : Owen Xiao  
 Owen Xiao  
 (Project Engineer)

Reviewed By : Aaron Cheng  
 Aaron Cheng  
 (Supervisor)

Approved By : Alex Li  
 Alex Li  
 (Manager)

※ ※ **Revision History** ※ ※

REV.	DESCRIPTION	ISSUED DATE	REMARK
Rev.1.0	Initial Test Report Release	Oct.23, 2024	Owen Xiao

## TABLE OF CONTENTS

1. General Information .....	6
1.1. RF exposure limits.....	6
1.2. Statement of Compliance .....	7
1.3. EUT Description .....	7
1.4. Test specification(s) .....	9
1.5. Ambient Condition.....	9
2. SAR Measurement System .....	10
2.1. SATIMO SAR Measurement Set-up Diagram .....	10
2.2. Robot .....	11
2.3. E-Field Probe.....	12
2.3.1. E-Field Probe Calibration .....	12
2.4. SAM phantoms .....	13
2.4.1. Technical Data .....	14
2.5. Device Holder .....	15
2.6. Test Equipment List .....	16
3. SAR Measurement Procedures .....	19
3.1. Power Reference .....	19
3.2. Area scan & Zoom scan.....	19
3.3. Description of interpolation/extrapolation scheme .....	21
3.4. Volumetric Scan .....	21
3.5. Power Drift .....	21
4. System Verification Procedure .....	22
4.1. Tissue Verification .....	22
4.1.1. Tissue Dielectric Parameter Check Results .....	23
4.2. System Verification Procedure .....	24
4.2.1. System Verification Results.....	25
5. SAR Measurement variability and uncertainty .....	26
5.1. SAR measurement variability.....	26
5.2. SAR measurement uncertainty .....	26
6. RF Exposure Positions.....	27
6.1. Ear and handset reference point .....	27
6.2. Definition of the cheek position .....	27
6.3. Definition of the tilt position .....	29
6.4. Body Worn Accessory .....	29
6.5. Wireless Router Devices .....	30
7. RF Output Power .....	31
7.1. GSM Conducted Power .....	31
7.2. WCDMA Conducted Power .....	31
7.3. LTE Conducted Power .....	33

7.4. WLAN & Bluetooth Output Power .....	48
7.5. NFC .....	50
8. Antenna Location.....	51
9. SAR Results .....	51
9.1. SAR measurement Result.....	51
9.1.1. SAR measurement Result of GSM850.....	51
9.1.2. SAR measurement Result of GSM1900.....	52
9.1.3. SAR measurement Result of WCDMA Band 2.....	54
9.1.4. SAR measurement Result of WCDMA Band 4.....	55
9.1.5. SAR measurement Result of WCDMA Band 5.....	56
9.1.6. SAR measurement Result of LTE Band 2 .....	57
9.1.7. SAR measurement Result of LTE Band 4 .....	59
9.1.8. SAR measurement Result of LTE Band 5 .....	61
9.1.9. SAR measurement Result of LTE Band 7 .....	63
9.1.10. SAR measurement Result of LTE Band 12 .....	65
9.1.11. SAR measurement Result of LTE Band 17 .....	67
9.1.12. SAR measurement Result of LTE Band 41 .....	69
9.1.13. SAR measurement Result of LTE Band 66 .....	72
9.1.14. SAR measurement Result of WLAN2.4G.....	73
9.1.15. SAR measurement Result of WLAN5.2G.....	74
9.1.16. SAR measurement Result of WLAN5.8G.....	75
9.2. Simultaneous Transmission Analysis.....	78
10. Appendix A. Photo documentation .....	80
11. Appendix B. System Check Plots.....	81
12. Appendix C. Plots of High SAR Measurement.....	98
13. Appendix D. Calibration Certificate .....	167

## 1. General Information

### 1.1. RF exposure limits

(A).Limits for Occupational/Controlled Exposure (W/kg)

Whole-Body	Partial-Body	Hands, Wrists, Feet and Ankles
0.4	8.0	20.0

(B).Limits for General Population/Uncontrolled Exposure (W/kg)

Whole-Body	Partial-Body	Hands, Wrists, Feet and Ankles
0.08	1.6	4.0

NOTE: **Whole-Body SAR** is averaged over the entire body, **partial-body SAR** is averaged over any 1 gram of tissue defined as a tissue volume in the shape of a cube. **SAR for hands, wrists, feet and ankles** is averaged over any 10 grams of tissue defined as a tissue volume in the shape of a cube.

#### **Occupational/Controlled Environments:**

Are defined as locations where there is exposure that may be incurred by people who are aware of the potential for exposure, (i.e. as a result of employment or occupation).

#### **General Population/Uncontrolled Environments:**

Are defined as locations where there is the exposure of individuals who have no knowledge or control of their exposure.

NOTE  
HEAD AND TRUNK LIMIT  
1.6 W/kg  
APPLIED TO THIS EUT

## 1.2. Statement of Compliance

The maximum results of Specific Absorption Rate (SAR) found during testing for BV7300 are as follows.

RF Exposure Conditions		Equipment Class -Highest Reported SAR (W/kg)				Max. Reported SAR (W/kg)
		PCE	DTS	NII	DSS	
1-g Head		0.228	0.425	0.517	0.055	0.517
1-g Body-Worn (Separation distance of 10mm)		1.435	0.149	0.123	0.031	1.435
1-g Hotspot (Separation distance of 10mm)		1.435	0.149	0.123	0.031	
Max Simultaneous Tx	Head	0.653	0.653	0.745	0.283	0.745
	Body-Worn	1.584	1.584	1.558	1.466	1.584
	Hotspot	1.584	1.584	1.558	1.466	

Note: The Max Simultaneous Tx is calculated based on the same configuration and test position.

This device is in compliance with Specific Absorption Rate (SAR) for general population/uncontrolled exposure limits (1.6 W/kg) specified in FCC 47 CFR Part 2(2.1093), and had been tested in accordance with the measurement methods and procedures specified in IEEE Std 1528-2013 & KDB 865664 D01.

## 1.3. EUT Description

Device Information	
Product Name	Smart phone
Brand Name	Blackview
Model Name	BV7300
Family Model	N/A
Model Difference	N/A
FCC ID	2A7DX-BV7300
Device Phase	Identical Prototype
Exposure Category	General population / Uncontrolled environment
Antenna Type	PIFA Antenna
Battery Information	DC 3.85V, 15000mAh, 57.75Wh
HW Version	HCT-M515-MBA3
SW Version	BV7300_EEA_M515_V1.0_A14
Device Operating Configurations	
Supporting Mode(s)	GSM850/1900,WCDMABand2/4/5,LTEBand2/4/5/7/12/17/41/66, WLAN 2.4G/5G, NFC, Bluetooth
Test Modulation	GSM(GMSK/8PSK), WCDMA(QPSK), LTE(QPSK/16QAM), WLAN(DSSS/OFDM), NFC(ASK),Bluetooth(GFSK, $\pi/4$ -DQPSK, 8DPSK)

Device Class	B		
Operating Frequency Range(s)	Band	Tx (MHz)	Rx (MHz)
	GSM 850	824-849	869-894
	GSM 1900	1850-1910	1930-1990
	WCDMA Band 2	1850-1910	1930-1990
	WCDMA Band 4	1710-1755	2110-2155
	WCDMA Band 5	824-849	869-894
	LTE Band 2	1850-1910	1930-1990
	LTE Band 4	1710-1755	2110-2155
	LTE Band 5	824-849	869-894
	LTE Band 7	2500-2570	2620-2690
	LTE Band 12	699-716	729-746
	LTE Band 17	704-716	734-746
	LTE Band 41	2540-2650	
	LTE Band 66	1710-1780	2110-2200
	WLAN 2.4G	2412-2462	
	WLAN 5.2G	5180-5240	
	WLAN 5.8G	5745-5825	
NFC	13.56-13.56		
Bluetooth	2402-2480		
GPRS Multislot Class(12)	Max Number of Timeslots in Uplink		4
	Max Number of Timeslots in Downlink		4
	Max Total Timeslot		5
EGPRS Multislot Class(12)	Max Number of Timeslots in Uplink		4
	Max Number of Timeslots in Downlink		4
	Max Total Timeslot		5
Power Class	4, tested with power level 5(GSM 850)		
	1, tested with power level 0(GSM 1900)		
	3, tested with power control "all 1"(WCDMA Band 2)		
	3, tested with power control "all 1"(WCDMA Band 4)		
	3, tested with power control "all 1"(WCDMA Band 5)		
	3, tested with power control all Max.(LTE Band 2)		
	3, tested with power control all Max.(LTE Band 4)		
	3, tested with power control all Max.(LTE Band 5)		
	3, tested with power control all Max.(LTE Band 7)		
	3, tested with power control all Max.(LTE Band 12)		
	3, tested with power control all Max.(LTE Band 17)		
	3, tested with power control all Max.(LTE Band 41)		
3, tested with power control all Max.(LTE Band 66)			



**1.4. Test specification(s)**

FCC 47 CFR Part 2(2.1093)
IEEE Std 1528-2013
KDB 865664 D01 SAR measurement 100 MHz to 6 GHz
KDB 865664 D02 RF Exposure Reporting
KDB 447498 D01 General RF Exposure Guidance
KDB 248227 D01 802.11 Wi-Fi SAR
KDB 941225 D01 3G SAR Procedures
KDB 941225 D05 SAR for LTE Devices
KDB 941225 D06 Hotspot SAR
KDB 648474 D04 Handset SAR

**1.5. Ambient Condition**

Ambient temperature	20°C – 24°C
Relative Humidity	30% – 70%

## 2. SAR Measurement System

### 2.1. SATIMO SAR Measurement Set-up Diagram

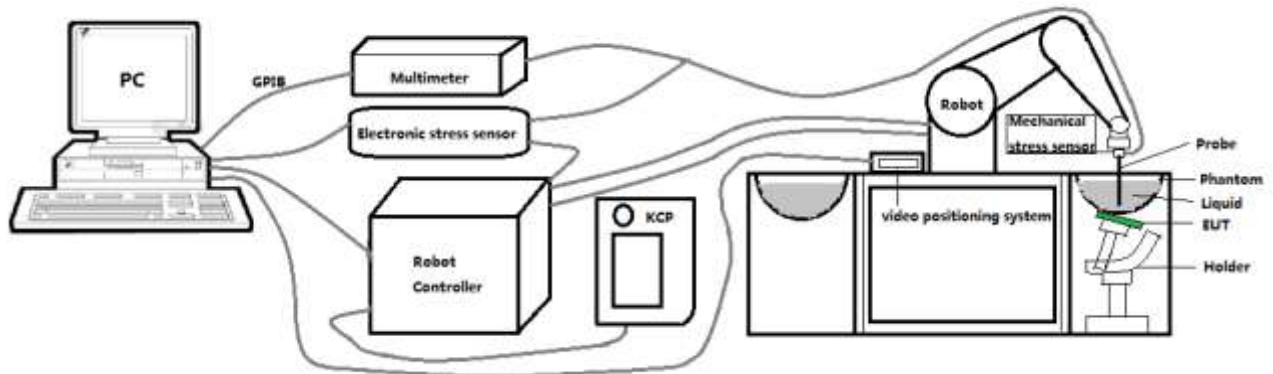

These measurements were performed with the automated near-field scanning system OPENSAR from SATIMO. The system is based on a high precision robot (working range: 901 mm), which positions the probes with a positional repeatability of better than  $\pm 0.03$  mm. The SAR measurements were conducted with dosimetric probe (manufactured by SATIMO), designed in the classical triangular configuration and optimized for dosimetric evaluation.

The first step of the field measurement is the evaluation of the voltages induced on the probe by the device under test. Probe diode detectors are nonlinear. Below the diode compression point, the output voltage is proportional to the square of the applied E-field; above the diode compression point, it is linear to the applied E-field. The compression point depends on the diode, and a calibration procedure is necessary for each sensor of the probe.

The Keithley multimeter reads the voltage of each sensor and send these three values to the PC. The corresponding E field value is calculated using the probe calibration factors, which are stored in the working directory. This evaluation includes linearization of the diode characteristics. The field calculation is done separately for each sensor. Each component of the E field is displayed on the "Dipole Area Scan Interface" and the total E field is displayed on the "3D Interface"

## 2.2. Robot

The SATIMO SAR system uses the high precision robots from KUKA. For the 6-axis controller system, the robot controller version (KUKA) from KUKA is used. The KUKA robot series have many features that are important for our application:



- High precision (repeatability  $\pm 0.03$  mm)
- High reliability (industrial design)
- Jerk-free straight movements
- Low ELF interference (the closed metallic construction shields against motor control fields)

### 2.3. E-Field Probe

This E-field detection probe is composed of three orthogonal dipoles linked to special Schottky diodes with low detection thresholds. The probe allows the measurement of electric fields in liquids such as the one defined in the IEEE and CENELEC standards.

For the measurements the Specific Dosimetric E-Field Probe 3423-EPGO-426 with following specifications is used



- Dynamic range: 0.01-100 W/kg
- Tip Diameter : 2.5 mm
- Distance between probe tip and sensor center: 1 mm
- Distance between sensor center and the inner phantom surface: 2 mm (repeatability better than  $\pm 1$  mm).
- Probe linearity:  $\pm 0.06$  dB
- Axial isotropy:  $\pm 0.01$  dB
- Hemispherical Isotropy:  $\pm 0.01$  dB
- Calibration range: 650MHz to 5900MHz for head & body simulating liquid.
- Lower detection limit: 8mW/kg

Angle between probe axis (evaluation axis) and surface normal line: less than  $30^\circ$ .

#### 2.3.1. E-Field Probe Calibration

Each probe needs to be calibrated according to a dosimetric assessment procedure with accuracy better than  $\pm 10\%$ . The spherical isotropy shall be evaluated and within  $\pm 0.25$ dB. The sensitivity parameters (Norm X, Norm Y, and Norm Z), the diode compression parameter (DCP) and the conversion factor (Conv F) of the probe are tested. The calibration data can be referred to appendix D of this report.

## 2.4. SAM phantoms

Photo of SAM phantom SN 16/15 SAM119



The SAM phantom is used to measure the SAR relative to people exposed to electro-magnetic field radiated by Mobile Phones.

2.4.1. Technical Data

Serial Number	Shell thickness	Filling volume	Dimensions	Positionner Material	Permittivity	Loss Tangent
SN 16/15 SAM119	2 mm ±0.2 mm	27 liters	Length:1000 mm Width:500 mm Height:200 mm	Gelcoat with fiberglass	3.4	0.02

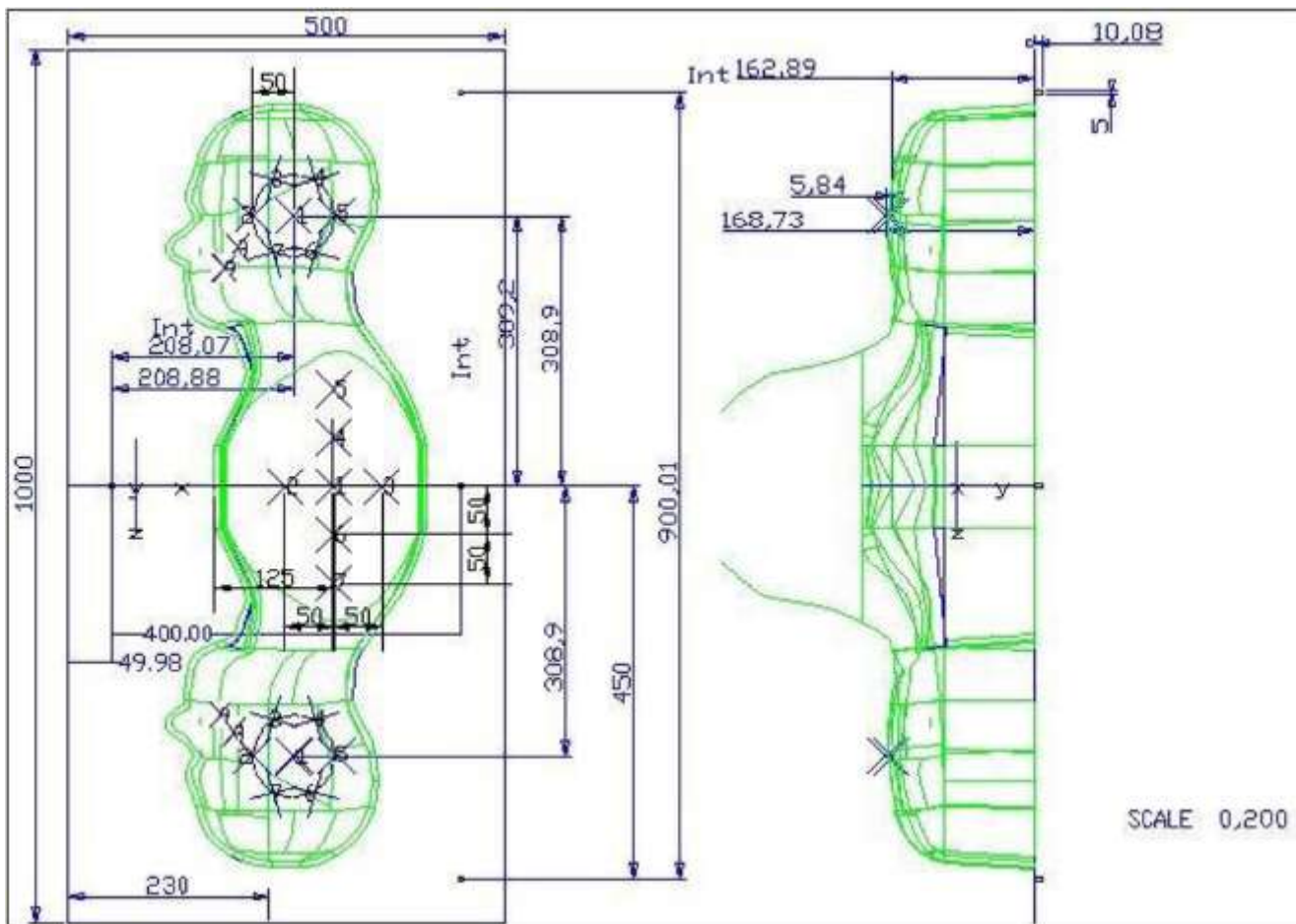

Serial Number	Left Head(mm)		Right Head(mm)		Flat Part(mm)	
	1	2	1	2	1	2
SN 16/15 SAM119	2	2.02	2	2.08	1	2.09
	3	2.05	3	2.06	2	2.06
	4	2.07	4	2.07	3	2.08
	5	2.08	5	2.08	4	2.10
	6	2.05	6	2.07	5	2.10
	7	2.05	7	2.05	6	2.07
	8	2.07	8	2.06	7	2.07
	9	2.08	9	2.06	-	-

The test, based on ultrasonic system, allows measuring the thickness with an accuracy of 10 µm.

## 2.5. Device Holder

The positioning system allows obtaining cheek and tilting position with a very good accuracy. In compliance with CENELEC, the tilt angle uncertainty is lower than 1 degree.

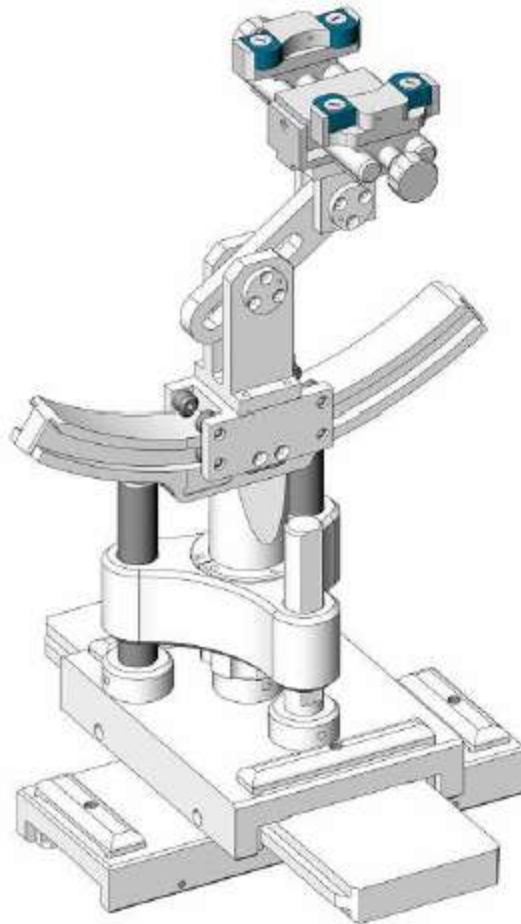

Serial Number	Holder Material	Permittivity	Loss Tangent
SN 16/15 MSH100	Delrin	3.7	0.005

## 2.6. Test Equipment List

This table gives a complete overview of the SAR measurement equipment.

Devices used during the test described are marked

	Manufacturer	Name of Equipment	Type/Model	Serial Number	Calibration	
					Last Cal.	Due Date
<input checked="" type="checkbox"/>	MVG	E FIELD PROBE	SSE2	4024-EPGO-442	Oct.4.2024	Oct.3.2025
<input checked="" type="checkbox"/>	MVG	E FIELD PROBE	SSE2	3423-EPGO-426	Sep. 18, 2023	Sep. 17, 2024
<input checked="" type="checkbox"/>	MVG	750 MHz Dipole	SID750	SN 03/15 DIP 0G750-355	Feb. 21, 2024	Feb. 20, 2027
<input checked="" type="checkbox"/>	MVG	835 MHz Dipole	SID835	SN 03/15 DIP 0G835-347	Feb. 21, 2024	Feb. 20, 2027
<input type="checkbox"/>	MVG	900 MHz Dipole	SID900	SN 03/15 DIP 0G900-348	Feb. 21, 2024	Feb. 20, 2027
<input checked="" type="checkbox"/>	MVG	1800 MHz Dipole	SID1800	SN 03/15 DIP 1G800-349	Feb. 21, 2024	Feb. 20, 2027
<input checked="" type="checkbox"/>	MVG	1900 MHz Dipole	SID1900	SN 03/15 DIP 1G900-350	Feb. 21, 2024	Feb. 20, 2027
<input type="checkbox"/>	MVG	2000 MHz Dipole	SID2000	SN 03/15 DIP 2G000-351	Feb. 21, 2024	Feb. 20, 2027
<input checked="" type="checkbox"/>	MVG	2450 MHz Dipole	SID2450	SN 03/15 DIP 2G450-352	Feb. 21, 2024	Feb. 20, 2027
<input checked="" type="checkbox"/>	MVG	2600 MHz Dipole	SID2600	SN 03/15 DIP 2G600-356	Feb. 21, 2024	Feb. 20, 2027
<input checked="" type="checkbox"/>	MVG	5000 MHz Dipole	SWG5500	SN 13/14 WGA 33	Feb. 21, 2024	Feb. 20, 2027
<input checked="" type="checkbox"/>	MVG	Liquid measurement Kit	SCLMP	SN 21/15 OCPG 72	NCR	NCR
<input checked="" type="checkbox"/>	MVG	Power Amplifier	N.A	AMPLISAR_28/14_003	NCR	NCR
<input checked="" type="checkbox"/>	KEITHLEY	Millivoltmeter	2000	4072790	NCR	NCR
<input checked="" type="checkbox"/>	R&S	Universal radio communication tester	CMU200	105747	Apr. 26, 2024	Apr. 25, 2025
<input checked="" type="checkbox"/>	R&S	Wideband radio communication	CMW500	103917	Apr. 26, 2024	Apr. 25, 2025



		tester				
<input checked="" type="checkbox"/>	HP	Network Analyzer	8753D	3410J01136	Apr. 26, 2024	Apr. 25, 2025
<input checked="" type="checkbox"/>	Agilent	MXG Vector Signal Generator	N5182A	MY47070317	Apr. 25, 2024	Apr. 24, 2025
<input checked="" type="checkbox"/>	Agilent	Power meter	E4419B	MY45102538	Apr. 25, 2024	Apr. 24, 2025
<input checked="" type="checkbox"/>	Agilent	Power sensor	E9301A	MY41495644	Apr. 25, 2024	Apr. 24, 2025
<input checked="" type="checkbox"/>	Agilent	Power sensor	E9301A	US39212148	Apr. 25, 2024	Apr. 24, 2025
<input checked="" type="checkbox"/>	MCLI/USA	Directional Coupler	CB11-20	0D2L51502	Apr. 26, 2024	Apr. 25, 2027
<input checked="" type="checkbox"/>	N/A	Thermometer	N/A	LES-085	Mar. 27, 2023	Mar. 26, 2026
<input checked="" type="checkbox"/>	MVG	SAM Phantom	SSM2	SN 16/15 SAM119	NCR	NCR
<input checked="" type="checkbox"/>	MVG	Device Holder	SMPPD	SN 16/15 MSH100	NCR	NCR
<input checked="" type="checkbox"/>	Shenzhen Tianxu Communication Technology Co., Ltd.	Human Simulating Liquid	Head 750	Head 750	NCR	NCR
<input checked="" type="checkbox"/>	Shenzhen Tianxu Communication Technology Co., Ltd.	Human Simulating Liquid	Head 835	Head 835	NCR	NCR
<input checked="" type="checkbox"/>	Shenzhen Tianxu Communication Technology Co., Ltd.	Human Simulating Liquid	Head 1800	Head 1800	NCR	NCR
<input checked="" type="checkbox"/>	Shenzhen Tianxu Communication Technology Co., Ltd.	Human Simulating Liquid	Head 1900	Head 1900	NCR	NCR
<input checked="" type="checkbox"/>	Shenzhen Tianxu	Human Simulating	Head 2450	Head 2450	NCR	NCR

	Communication Technology Co., Ltd.	Liquid				
<input checked="" type="checkbox"/>	Shenzhen Tianxu Communication Technology Co., Ltd.	Human Simulating Liquid	Head 2600	Head 2600	NCR	NCR
<input checked="" type="checkbox"/>	Shenzhen Tianxu Communication Technology Co., Ltd.	Human Simulating Liquid	Head 5000	Head 5000	NCR	NCR

Measurement Software

Manufacturer	Software Name	Software Version
SATIMO	OpenSAR	V4_02_31

### 3. SAR Measurement Procedures

The measurement procedures are as follows:

<Conducted power measurement>

- (a) For WWAN power measurement, use base station simulator to configure EUT WWAN transmission in conducted connection with RF cable, at maximum power in each supported wireless interface and frequency band.
- (b) Read the WWAN RF power level from the base station simulator.
- (c) For Wi-Fi/BT power measurement, use engineering software to configure EUT Wi-Fi/BT continuously transmission, at maximum RF power in each supported wireless interface and frequency band.
- (d) Connect EUT RF port through RF cable to the power meter, and measure Wi-Fi/BT output power.

<SAR measurement>

- (a) Use base station simulator to configure EUT WWAN transmission in radiated connection, and engineering software to configure EUT Wi-Fi/BT continuously transmission, at maximum RF power, in the highest power channel.
- (b) Place the EUT in the positions as Appendix A demonstrates.
- (c) Set scan area, grid size and other setting on the OPENSAR software.
- (d) Measure SAR results for the highest power channel on each testing position.
- (e) Find out the largest SAR result on these testing positions of each band.
- (f) Measure SAR results for other channels in worst SAR testing position if the reported SAR of highest power channel is larger than 0.8 W/kg.

According to the test standard, the recommended procedure for assessing the peak spatial-average SAR value consists of the following steps:

- (a) Power reference measurement
- (b) Area scan
- (c) Zoom scan
- (d) Power drift measurement

#### 3.1. Power Reference

The Power Reference Measurement and Power Drift Measurements are for monitoring the power drift of the device under test in the batch process. The minimum distance of probe sensors to surface determines the closest measurement point to phantom surface. This distance cannot be smaller than the distance of sensor calibration points to probe tip as defined in the probe properties.

#### 3.2. Area scan & Zoom scan

The area scan is a 2D scan to find the hot spot location on the DUT. The zoom scan is a 3D scan

above the hot spot to calculate the 1g and 10g SAR value.

Measurement of the SAR distribution with a grid of 8 to 16 mm \* 8 to 16 mm and a constant distance to the inner surface of the phantom. Since the sensors cannot directly measure at the inner phantom surface, the values between the sensors and the inner phantom surface are extrapolated. With these values the area of the maximum SAR is calculated by an interpolation scheme. Around this point, a cube of 30 \* 30 \* 30 mm or 32 \* 32 \* 32 mm is assessed by measuring 5 or 8 \* 5 or 8 \* 4 or 5 mm. With these data, the peak spatial-average SAR value can be calculated.

From the scanned SAR distribution, identify the position of the maximum SAR value, in addition identify the positions of any local maxima with SAR values within 2 dB of the maximum value that will not be within the zoom scan of other peaks; additional peaks shall be measured only when the primary peak is within 2 dB of the SAR compliance limit (e.g., 1 W/kg for 1,6 W/kg 1 g limit, or 1,26 W/kg for 2 W/kg, 10 g limit).

Area scan & Zoom scan scan parameters extracted from FCC KDB 865664 D01 SAR measurement 100 MHz to 6 GHz.

		≤ 3 GHz	> 3 GHz
Maximum distance from closest measurement point (geometric center of probe sensors) to phantom surface		5 ± 1 mm	$\frac{1}{2} \cdot \delta \cdot \ln(2) \pm 0.5$ mm
Maximum probe angle from probe axis to phantom surface normal at the measurement location		30° ± 1°	20° ± 1°
Maximum area scan spatial resolution: $\Delta x_{Area}$ , $\Delta y_{Area}$		≤ 2 GHz: ≤ 15 mm 2 – 3 GHz: ≤ 12 mm	3 – 4 GHz: ≤ 12 mm 4 – 6 GHz: ≤ 10 mm
		When the x or y dimension of the test device, in the measurement plane orientation, is smaller than the above, the measurement resolution must be ≤ the corresponding x or y dimension of the test device with at least one measurement point on the test device.	
Maximum zoom scan spatial resolution: $\Delta x_{Zoom}$ , $\Delta y_{Zoom}$		≤ 2 GHz: ≤ 8 mm 2 – 3 GHz: ≤ 5 mm*	3 – 4 GHz: ≤ 5 mm* 4 – 6 GHz: ≤ 4 mm*
Maximum zoom scan spatial resolution, normal to phantom surface	uniform grid: $\Delta z_{Zoom}(n)$	≤ 5 mm	3 – 4 GHz: ≤ 4 mm 4 – 5 GHz: ≤ 3 mm 5 – 6 GHz: ≤ 2 mm
	graded grid	$\Delta z_{Zoom}(1)$ : between 1 <sup>st</sup> two points closest to phantom surface	≤ 4 mm  3 – 4 GHz: ≤ 3 mm 4 – 5 GHz: ≤ 2.5 mm 5 – 6 GHz: ≤ 2 mm
		$\Delta z_{Zoom}(n>1)$ : between subsequent points	≤ 1.5 · $\Delta z_{Zoom}(n-1)$
Minimum zoom scan volume	x, y, z	≥ 30 mm	3 – 4 GHz: ≥ 28 mm 4 – 5 GHz: ≥ 25 mm 5 – 6 GHz: ≥ 22 mm

Note:  $\delta$  is the penetration depth of a plane-wave at normal incidence to the tissue medium; see draft standard IEEE P1528-2011 for details.

\* When zoom scan is required and the *reported* SAR from the *area scan based 1-g SAR estimation* procedures of KDB 447498 is ≤ 1.4 W/kg, ≤ 8 mm, ≤ 7 mm and ≤ 5 mm zoom scan resolution may be applied, respectively, for 2 GHz to 3 GHz, 3 GHz to 4 GHz and 4 GHz to 6 GHz.

### 3.3. Description of interpolation/extrapolation scheme

The local SAR inside the phantom is measured using small dipole sensing elements inside a probe body. The probe tip must not be in contact with the phantom surface in order to minimise measurements errors, but the highest local SAR will occur at the surface of the phantom.

An extrapolation is used to determine this highest local SAR value. The extrapolation is based on a fourth-order least-square polynomial fit of measured data. The local SAR value is then extrapolated from the liquid surface with a 1 mm step.

The measurements have to be performed over a limited time (due to the duration of the battery) so the step of measurement is high. It could vary between 5 and 8 mm. To obtain an accurate assessment of the maximum SAR averaged over 10 grams and 1 gram requires a very fine resolution in the three dimensional scanned data array.

### 3.4. Volumetric Scan

The volumetric scan consists to a full 3D scan over a specific area. This 3D scan is useful for multi Tx SAR measurement. Indeed, it is possible with OpenSAR to add, point by point, several volumetric scans to calculate the SAR value of the combined measurement as it is defined in the standard IEEE1528 and IEC62209.

### 3.5. Power Drift

All SAR testing is under the EUT install full charged battery and transmit maximum output power. In OpenSAR measurement software, the power reference measurement and power drift measurement procedures are used for monitoring the power drift of EUT during SAR test. Both these procedures measure the field at a specified reference position before and after the SAR testing. The software will calculate the field difference in V/m. If the power drifts more than  $\pm 5\%$ , the SAR will be retested.

## 4. System Verification Procedure

### 4.1. Tissue Verification

The following tissue formulations are provided for reference only as some of the parameters have not been thoroughly verified. The composition of ingredients may be modified accordingly to achieve the desired target tissue parameters required for routine SAR evaluation.

Ingredients (% of weight)	Head Tissue									
	750	835	900	1800	1900	2000	2450	2600	5200	5800
Frequency Band (MHz)										
Water	34.40	34.40	34.40	55.36	55.36	57.87	57.87	57.87	65.53	65.53
NaCl	0.79	0.79	0.79	0.35	0.35	0.16	0.16	0.16	0.00	0.00
1,2-Propanediol	64.81	64.81	64.81	0.00	0.00	0.00	0.00	0.00	0.00	0.00
Triton X-100	0.00	0.00	0.00	30.45	30.45	19.97	19.97	19.97	24.24	24.24
DGBE	0.00	0.00	0.00	13.84	13.84	22.00	22.00	22.00	10.23	10.23

For SAR measurement of the field distribution inside the phantom, the phantom must be filled with homogeneous tissue simulating liquid to a depth of at least 15 cm. For head SAR testing, the liquid depth from the ear reference point (ERP) of the phantom to the liquid top surface is larger than 15 cm.

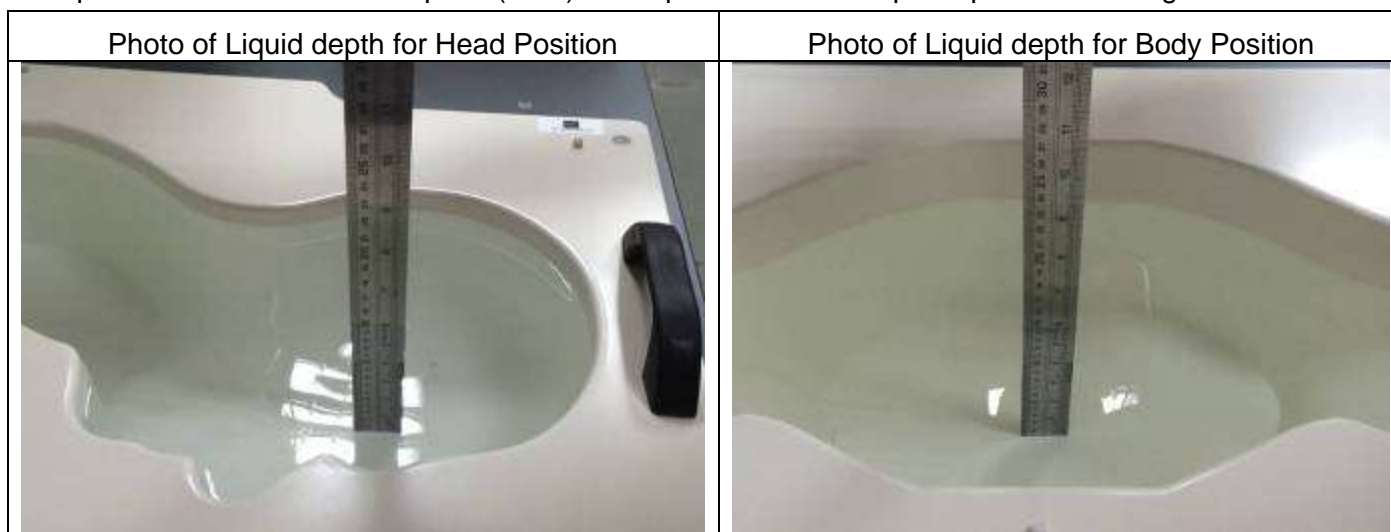

#### 4.1.1. Tissue Dielectric Parameter Check Results

The simulating liquids should be checked at the beginning of a series of SAR measurements to determine if the dielectric parameters are within the tolerances of the specified target values. The measured conductivity and relative permittivity should be within  $\pm 5\%$  of the target values.

Tissue Type	Measured Frequency (MHz)	Target Tissue		Measured Tissue		Liquid Temp.	Test Date
		$\epsilon_r$ ( $\pm 5\%$ )	$\sigma$ (S/m) ( $\pm 5\%$ )	$\epsilon_r$	$\sigma$ (S/m)		
Head 750	750	41.96 (39.86~44.06)	0.89 (0.85~0.93)	40.42	0.89	21.7 °C	Oct. 08, 2024
Head 850	835	41.50 (39.43~43.58)	0.90 (0.86~0.95)	42.09	0.92	21.9 °C	Oct. 10, 2024
Head 1800	1800	40.00 (38.00~42.00)	1.40 (1.33~1.47)	39.32	1.37	21.7 °C	Sep. 13, 2024
Head 1900	1900	40.00 (38.00~42.00)	1.40 (1.33~1.47)	38.44	1.45	21.8 °C	Oct. 12, 2024
Head 2450	2450	39.20 (37.24~41.16)	1.80 (1.71~1.89)	40.11	1.83	21.8 °C	Sep. 16, 2024
Head 2600	2600	39.01 (37.06~40.96)	1.96 (1.86~2.06)	38.95	2.03	21.2 °C	Oct. 13, 2024
Head 5200	5200	36.00 (34.20~37.80)	4.66 (4.43~4.89)	36.75	4.55	21.5 °C	Oct. 05, 2024
Head 5800	5800	35.30 (33.54~37.07)	5.27 (5.01~5.53)	35.28	5.08	21.6 °C	Oct. 07, 2024

NOTE: The dielectric parameters of the tissue-equivalent liquid should be measured under similar ambient conditions and within 2 °C of the conditions expected during the SAR evaluation to satisfy protocol requirements.



## 4.2. System Verification Procedure

The system verification is performed for verifying the accuracy of the complete measurement system and performance of the software. The dipole is connected to the signal source consisting of signal generator and amplifier via a directional coupler, N-connector cable and adaption to SMA. It is fed with a power of 100mW (below 5GHz) or 100mW (above 5GHz). To adjust this power a power meter is used. The power sensor is connected to the cable before the system verification to measure the power at this point and do adjustments at the signal generator. At the outputs of the directional coupler both return loss as well as forward power are controlled during the system verification to make sure that emitted power at the dipole is kept constant. This can also be checked by the power drift measurement after the test (result on plot).

The system verification is shown as below picture:

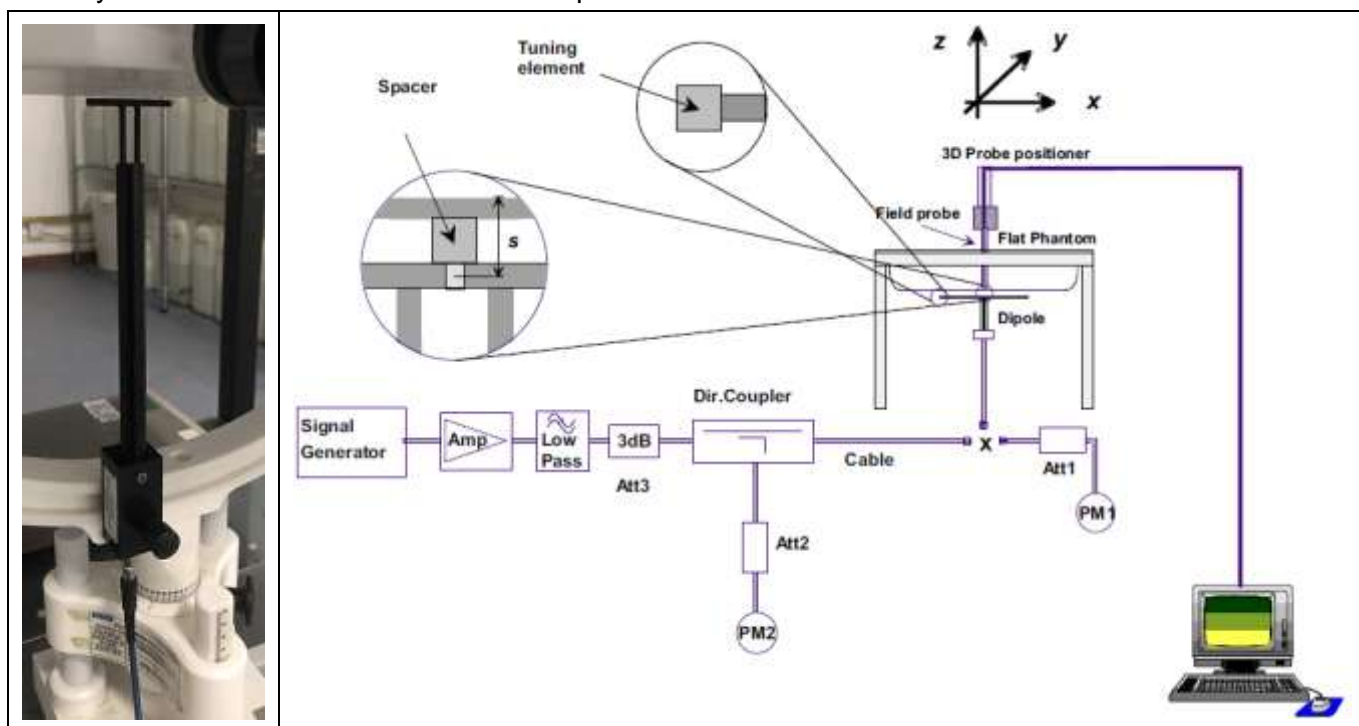



#### 4.2.1. System Verification Results

Comparing to the original SAR value provided by SATIMO, the verification data should be within its specification of  $\pm 10\%$ . Below table shows the target SAR and measured SAR after normalized to 1W input power. The table below indicates the system performance verification can meet the variation criterion and the plots can be referred to Appendix B of this report.

System Verification	Target SAR (1W)		Measured SAR		Liquid Temp.	Test Date
	$(\pm 10\%)$		(Normalized to 1W)			
	1-g (W/Kg)	10-g (W/Kg)	1-g (W/Kg)	10-g (W/Kg)		
750MHz	8.60 (7.74~9.46)	5.78 (5.20~6.36)	8.64	5.82	21.7 °C	Oct. 08, 2024
835MHz	9.40 (8.46~10.34)	6.28 (5.65~6.91)	10.21	6.53	21.9 °C	Oct. 10, 2024
1800MHz	37.06 (33.35~40.77)	20.01 (18.01~22.01)	38.53	19.95	21.7 °C	Sep. 13, 2024
1900MHz	39.69 (35.72~43.66)	20.92 (18.83~23.01)	42.10	20.61	21.8 °C	Oct. 12, 2024
2450MHz	50.05 (45.05~55.06)	23.80 (21.42~26.18)	47.60	22.78	21.8 °C	Sep. 16, 2024
2600MHz	54.16 (48.74~59.58)	24.85 (22.37~27.34)	54.16	24.61	21.2 °C	Oct. 13, 2024
5200MHz	162.59 (146.33~178.85)	56.21 (50.59~61.83)	153.60	55.63	21.5 °C	Oct. 05, 2024
5800MHz	182.20 (163.98~200.42)	61.32 (55.19~67.45)	186.60	57.54	21.6 °C	Oct. 07, 2024

## 5. SAR Measurement variability and uncertainty

### 5.1. SAR measurement variability

Per KDB865664 D01 SAR measurement 100 MHz to 6 GHz, SAR measurement variability must be assessed for each frequency band, which is determined by the SAR probe calibration point and tissue-equivalent medium used for the device measurements. The additional measurements are repeated after the completion of all measurements requiring the same head or body tissue-equivalent medium in a frequency band. The test device should be returned to ambient conditions (normal room temperature) with the battery fully charged before it is re-mounted on the device holder for the repeated measurement(s) to minimize any unexpected variations in the repeated results.

- 1) Repeated measurement is not required when the original highest measured SAR is  $< 0.80$  W/kg; steps 2) through 4) do not apply.
- 2) When the original highest measured SAR is  $\geq 0.80$  W/kg, repeat that measurement once.
- 3) Perform a second repeated measurement only if the ratio of largest to smallest SAR for the original and first repeated measurements is  $> 1.20$  or when the original or repeated measurement is  $\geq 1.45$  W/kg (~ 10% from the 1-g SAR limit).
- 4) Perform a third repeated measurement only if the original, first or second repeated measurement is  $\geq 1.5$  W/kg and the ratio of largest to smallest SAR for the original, first and second repeated measurements is  $> 1.20$ .

### 5.2. SAR measurement uncertainty

Per KDB865664 D01 SAR Measurement 100 MHz to 6 GHz, when the highest measured 1-g SAR within a frequency band is  $< 1.5$  W/kg, the extensive SAR measurement uncertainty analysis described in IEEE Std 1528-2013 is not required in SAR reports submitted for equipment approval. The equivalent ratio (1.5/1.6) is applied to extremity and occupational exposure conditions.

## 6. RF Exposure Positions

### 6.1. Ear and handset reference point

Figure 6.1.1 shows the front, back, and side views of the SAM phantom. The center-of-mouth reference point is labeled “M”, the left ear reference point (ERP) is marked “LE”, and the right ERP is marked “RE”.



Fig 6.1.1 Front, back, and side views of SAM phantom

### 6.2. Definition of the cheek position

1. Define two imaginary lines on the handset, the vertical centerline and the horizontal line. The vertical centerline passes through two points on the front side of the handset: the midpoint of the width  $w_t$  of the handset at the level of the acoustic output (point A in Figure 6.2.1 and Figure 6.2.2), and the midpoint of the width  $w_b$  of the bottom of the handset (point B). The horizontal line is perpendicular to the vertical centerline and passes through the center of the acoustic output (see Figure 6.2.1). The two lines intersect at point A. Note that for many handsets, point A coincides with the center of the acoustic output; however, the acoustic output may be located elsewhere on the horizontal line. Also note that the vertical centerline is not necessarily parallel to the front face of the handset (see Figure 6.2.2), especially for clamshell handsets, handsets with flip covers, and other irregularly-shaped handsets.
2. Position the handset close to the surface of the phantom such that point A is on the (virtual) extension of the line passing through points RE and LE on the phantom (see Figure 6.2.3), such that the plane defined by the vertical centerline and the horizontal line of the handset is approximately parallel to the sagittal plane of the phantom.
3. Translate the handset towards the phantom along the line passing through RE and LE until handset point A touches the pinna at the ERP
4. While maintaining the handset in this plane, rotate it around the LE-RE line until the vertical centerline is in the plane normal to the plane containing B-M and N-F lines, i.e., the Reference Plane.
5. Rotate the handset around the vertical centerline until the handset (horizontal line) is parallel to the N-F line.

6. While maintaining the vertical centerline in the Reference Plane, keeping point A on the line passing through RE and LE, and maintaining the handset contact with the pinna, rotate the handset about the N-F line until any point on the handset is in contact with a phantom point below the pinna on the cheek. See Figure 6.2.3. The actual rotation angles should be documented in the test report.

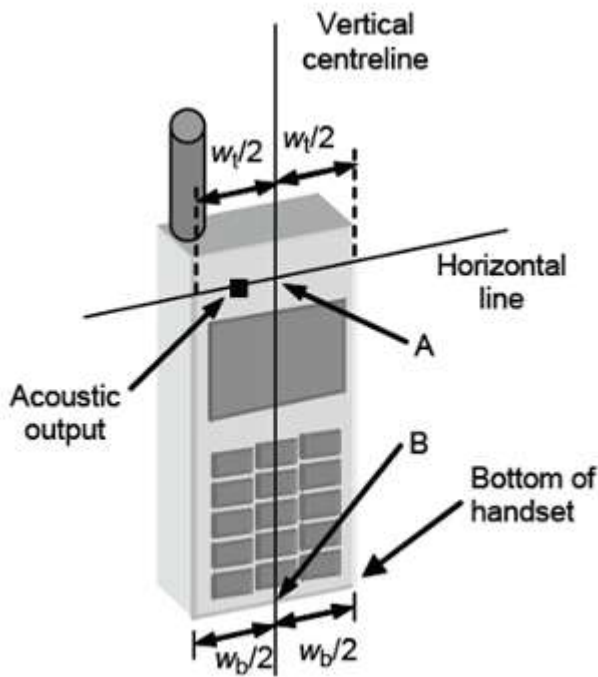

Fig 6.2.1 Handset vertical and horizontal reference lines—"fixed case"

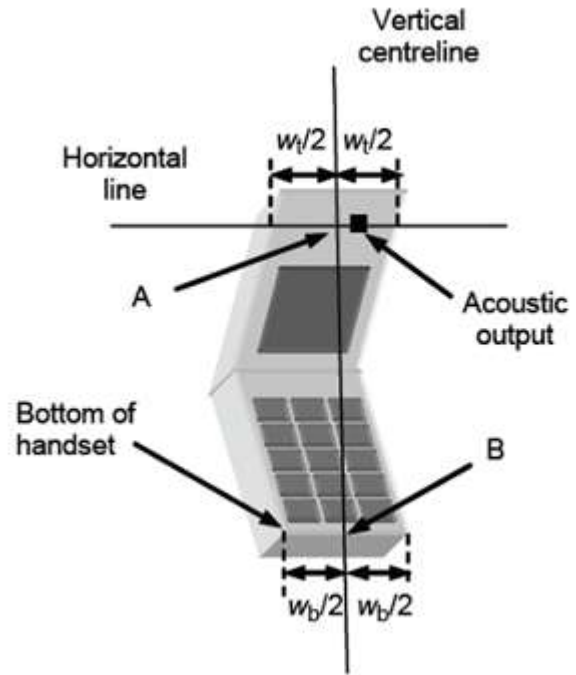

Fig 6.2.2 Handset vertical and horizontal reference lines—"clam-shell case"

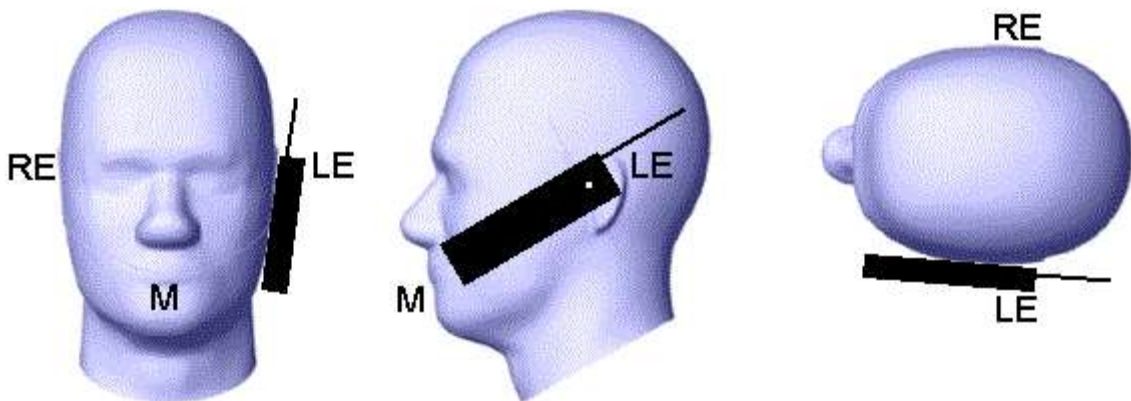

Fig 6.2.3 cheek or touch position. The reference points for the right ear (RE), left ear (LE), and mouth (M), which establish the Reference Plane for handset positioning, are indicated.

### 6.3. Definition of the tilt position

1. While maintaining the orientation of the handset, retract the handset parallel to the reference plane far enough away from the phantom to enable a rotation of the device by 15 degree.
2. Rotate the Handset around the horizontal line by 15 degree (see Figure 6.3.1).
3. While maintaining the orientation of the handset, move the handset towards the phantom on a line passing through RE and LE until any part of the handset touches the ear. The tilt position is obtained when the contact is on the pinna. If the contact is at any location other than the pinna, e.g., the antenna with the back of the phantom head, the angle of the handset shall be reduced. In this case, the tilt position is obtained if any part of the handset is in contact with the pinna as well as a second part of the handset is in contact with the phantom, e.g., the antenna with the back of the head.



Figure 6.3.1 – Tilt position of the wireless device on the left side of SAM

### 6.4. Body Worn Accessory

1. Body-worn operating configurations are tested with the belt-clips and holsters attached to the device and positioned against a flat phantom in a normal use configuration (see Figure 6.4.1). Per KDB 648474 D04, body-worn accessory exposure is typically related to voice mode operations when handsets are carried in body-worn accessories. The body-worn accessory procedures in FCC KDB 447498 D01 should be used to test for body-worn accessory SAR compliance, without a headset connected to it. This enables the test results for such configuration to be compatible with that required for hotspot mode when the body-worn accessory test separation distance is greater than or equal to that required for hotspot mode, when applicable. When the reported SAR for body-worn accessory, measured without a headset connected to the handset is  $< 1.2 \text{ W/kg}$ , the highest reported SAR configuration for that wireless mode and frequency band should be repeated for that body-worn accessory with a handset attached to the handset.
2. Accessories for body-worn operation configurations are divided into two categories: those that do not contain metallic components and those that do contain metallic components and those that do contain metallic components. When multiple accessories that do not contain metallic components are supplied with the device, the device is tested with only the accessory that dictates the closest

spacing to the body. Then multiple accessories that contain metallic components are test with the device with each accessory. If multiple accessories share an identical metallic component (i.e. the same metallic belt-clip used with different holsters with no other metallic components) only the accessory that dictates the closest spacing to the body is tested.

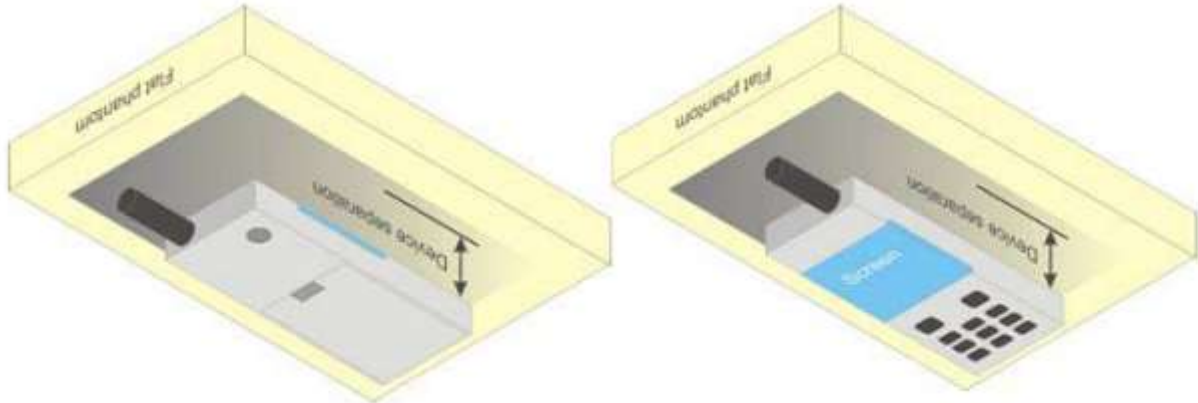

Figure 6.4.1 – Test positions for body-worn devices

## 6.5. Wireless Router Devices

Some battery-operated handsets have the capability to transmit and receive user through simultaneous transmission of WLAN simultaneously with a separate licensed transmitter. The FCC has provided guidance in FCC KDB Publication 941225 D06 where SAR test considerations for handsets ( $L \times W \geq 9 \text{ cm} \times 5 \text{ cm}$ ) are based on a composite test separation distance of 10mm from the front, back and edges of the device containing transmitting antennas within 2.5cm of their edges, determined from general mixed use conditions for this type of devices. Since the hotspot SAR results may overlap with the body-worn accessory SAR requirements, the more conservative configurations can be considered, thus excluding some body-worn accessory SAR tests.

When the user enables the personal wireless router functions for the handset, actual operations include simultaneous transmission of both the WLAN transmitter and another licensed transmitter. Both transmitters often do not transmit at the same transmitting frequency and thus cannot be evaluated for SAR under actual use conditions due to the limitations of the SAR assessment probes. Therefore, SAR must be evaluated for each frequency transmission and mode separately and spatially summed with the WLAN transmitter according to FCC KDB Publication 447498 D01 publication procedures. The “Portable Hotspot” feature on the handset was NOT activated during SAR assessments, to ensure the SAR measurements were evaluated for a single transmission frequency RF signal at a time.



## 7. RF Output Power

### 7.1. GSM Conducted Power

Band GSM850	Burst-Averaged output Power (dBm)				Frame-Averaged output Power (dBm)			
Tx Channel	Tune-up (dBm)	128	189	251	Tune-up (dBm)	128	189	251
Frequency (MHz)		824.2	836.4	848.8		824.2	836.4	848.8
GSM (GMSK)	32.50	32.10	32.00	32.08	23.47	23.07	22.97	23.05
GPRS(GMSK,1 Tx slot)	32.50	32.09	31.99	32.07	23.47	23.06	22.96	23.04
GPRS(GMSK,2 Tx slot)	32.00	31.51	31.39	31.44	25.98	25.49	25.37	25.42
GPRS(GMSK,3 Tx slot)	30.00	29.96	29.80	29.85	25.74	25.70	25.54	25.59
GPRS(GMSK,4 Tx slot)	29.00	28.90	28.74	28.77	25.99	25.89	25.73	25.76
EGPRS(8PSK,1 Tx slot)	32.50	32.10	32.00	32.05	23.47	23.07	22.97	23.02
EGPRS(8PSK,2 Tx slot)	32.00	31.51	31.37	31.44	25.98	25.49	25.35	25.42
EGPRS(8PSK,3 Tx slot)	30.00	29.97	29.80	29.85	25.74	25.71	25.54	25.59
EGPRS(8PSK,4 Tx slot)	29.00	28.89	28.75	28.78	25.99	25.88	25.74	25.77
Band GSM1900	Burst-Averaged output Power (dBm)				Frame-Averaged output Power (dBm)			
Tx Channel	Tune-up (dBm)	512	661	810	Tune-up (dBm)	512	661	810
Frequency (MHz)		1850.2	1880	1909.8		1850.2	1880	1909.8
GSM (GMSK)	28.00	27.41	27.48	27.74	18.97	18.38	18.45	18.71
GPRS(GMSK,1 Tx slot)	28.00	27.36	27.45	27.72	18.97	18.33	18.42	18.69
GPRS(GMSK,2 Tx slot)	27.00	26.59	26.67	26.96	20.98	20.57	20.65	20.94
GPRS(GMSK,3 Tx slot)	25.50	24.87	24.95	25.23	21.24	20.61	20.69	20.97
GPRS(GMSK,4 Tx slot)	24.50	23.84	23.89	24.20	21.49	20.83	20.88	21.19
EGPRS(8PSK,1 Tx slot)	28.00	27.37	27.44	27.73	18.97	18.34	18.41	18.70
EGPRS(8PSK,2 Tx slot)	27.00	26.60	26.68	26.94	20.98	20.58	20.66	20.92
EGPRS(8PSK,3 Tx slot)	25.50	24.88	24.95	25.26	21.24	20.62	20.69	21.00
EGPRS(8PSK,4 Tx slot)	24.50	23.86	23.89	24.19	21.49	20.85	20.88	21.18

### 7.2. WCDMA Conducted Power

WCDMA Band 2	Burst-Averaged output Power (dBm)			
Tx Channel	Tune-up (dBm)	9262	9400	9538
Frequency (MHz)		1852.4	1880	1907.6
RMC12.2K	22.00	21.94	21.27	21.53
HSDPA Sub 1	22.00	21.70	20.38	20.32
HSDPA Sub 2	21.50	21.32	19.85	19.83

HSDPA Sub 3	20.50	20.05	18.77	18.99
HSDPA Sub 4	20.50	20.01	18.97	18.58
HSUPA Sub 1	20.00	19.79	19.95	19.79
HSUPA Sub 2	21.50	21.24	20.05	19.91
HSUPA Sub 3	20.00	19.78	18.54	18.70
HSUPA Sub 4	21.50	21.21	20.04	20.02
HSUPA Sub 5	20.00	19.77	19.18	19.18
WCDMA Band 4	Burst-Averaged output Power (dBm)			
Tx Channel	Tune-up (dBm)	1312	1413	1513
Frequency (MHz)		1712.4	1732.6	1752.6
RMC12.2K	21.50	21.36	20.83	20.93
HSDPA Sub 1	21.50	21.31	20.80	20.90
HSDPA Sub 2	21.50	21.34	20.79	20.91
HSDPA Sub 3	21.50	21.23	20.54	20.91
HSDPA Sub 4	21.50	21.31	20.57	20.90
HSUPA Sub 1	21.50	21.31	20.79	20.90
HSUPA Sub 2	21.50	21.30	20.80	20.89
HSUPA Sub 3	21.50	21.33	20.56	20.77
HSUPA Sub 4	21.50	21.28	20.78	20.88
HSUPA Sub 5	21.50	21.33	20.80	20.88
WCDMA Band 5	Burst-Averaged output Power (dBm)			
Tx Channel	Tune-up (dBm)	4132	4182	4233
Frequency (MHz)		826.4	836.4	846.6
RMC12.2K	22.50	22.38	22.38	22.25
HSDPA Sub 1	22.50	22.34	22.30	22.25
HSDPA Sub 2	23.00	22.37	22.50	22.23
HSDPA Sub 3	23.00	22.18	22.50	22.24
HSDPA Sub 4	23.00	21.81	22.51	22.23
HSUPA Sub 1	22.50	22.34	22.49	22.23
HSUPA Sub 2	22.50	22.34	22.48	22.25
HSUPA Sub 3	23.00	22.32	22.50	22.23
HSUPA Sub 4	23.00	22.28	22.50	22.14
HSUPA Sub 5	23.00	22.34	22.51	22.26



**7.3. LTE Conducted Power**

Band	Band Width	Modulation	RB Configuration		Tune-up (dBm)	Channel/Frequency(MHz)		
			RB Size	RB Offset		18607/1850.7	18900/1880	19193/1909.3
LTE Band 2	1.4MHz	QPSK	1	0	22.50	21.36	21.56	22.32
			1	2	22.50	21.48	21.69	22.44
			1	5	22.50	21.35	21.56	22.34
			3	0	22.50	21.46	21.63	22.43
			3	1	22.50	21.49	21.62	22.46
			3	2	22.50	21.47	21.64	22.42
			6	0	21.50	20.44	20.63	21.46
		16QAM	1	0	22.00	20.72	20.82	21.51
			1	2	22.00	20.74	21.01	21.65
			1	5	22.00	20.67	20.87	21.61
			3	0	21.50	20.53	20.64	21.35
			3	1	21.50	20.48	20.63	21.45
			3	2	21.50	20.46	20.63	21.39
			6	0	21.00	19.63	19.80	20.56
Band	Band Width	Modulation	RB Configuration		Tune-up (dBm)	Channel/Frequency(MHz)		
			RB Size	RB Offset		18615/1851.5	18900/1880	19185/1908.5
LTE Band 2	3MHz	QPSK	1	0	22.50	21.51	21.67	22.40
			1	7	22.50	21.48	21.69	22.43
			1	14	22.50	21.46	21.69	22.45
			8	0	22.00	20.52	20.67	21.42
			8	4	22.00	20.54	20.72	21.51
			8	7	22.00	20.49	20.71	21.49
			15	0	21.50	20.50	20.66	21.47
		16QAM	1	0	22.00	20.75	21.05	21.58
			1	7	22.00	20.87	20.90	21.63
			1	14	22.00	20.71	21.02	21.70
			8	0	21.00	19.67	19.81	20.47
			8	4	21.00	19.64	19.86	20.56
			8	7	21.00	19.59	19.81	20.55
			15	0	20.50	19.56	19.76	20.47
Band	Band Width	Modulation	RB Configuration		Tune-up (dBm)	Channel/Frequency(MHz)		
			RB Size	RB Offset		18625/1852.5	18900/1880	19175/1907.5
LTE	5MHz	QPSK	1	0	22.50	21.33	21.46	22.15

Band 2			1	12	22.50	21.40	21.64	22.32
			1	24	22.50	21.19	21.53	22.26
			12	0	21.50	20.45	20.54	21.26
			12	6	21.50	20.42	20.65	21.42
			12	11	21.50	20.34	20.65	21.43
			25	0	21.50	20.42	20.61	21.35
			25	6	21.50	20.42	20.61	21.35
		16QAM	1	0	22.00	20.57	20.78	21.44
			1	12	22.00	20.77	20.96	21.66
			1	24	22.00	20.52	20.74	21.51
			12	0	20.50	19.48	19.60	20.28
			12	6	20.50	19.50	19.72	20.43
			12	11	20.50	19.39	19.71	20.44
			25	0	20.50	19.48	19.69	20.39
Band	Band Width	Modulation	RB Configuration		Tune-up (dBm)	Channel/Frequency(MHz)		
			RB Size	RB Offset		18650/1855	18900/1880	19150/1905
LTE Band 2	10MHz	QPSK	1	0	22.50	21.42	21.53	21.95
			1	24	22.50	21.46	21.71	22.38
			1	49	22.50	21.17	21.59	22.36
			25	0	21.50	20.46	20.59	21.21
			25	12	21.50	20.37	20.70	21.32
			25	24	21.50	20.20	20.78	21.48
			50	0	21.50	20.34	20.71	21.37
		16QAM	1	0	22.00	20.65	20.81	21.18
			1	24	22.00	20.80	21.07	21.67
			1	49	22.00	20.45	20.95	21.59
			25	0	21.00	19.53	19.64	20.26
			25	12	21.00	19.45	19.76	20.36
			25	24	21.00	19.24	19.83	20.50
			50	0	20.50	19.40	19.76	20.39
Band	Band Width	Modulation	RB Configuration		Tune-up (dBm)	Channel/Frequency(MHz)		
			RB Size	RB Offset		18675/1857.5	18900/1880	19125/1902.5
LTE Band 2	15MHz	QPSK	1	0	22.50	21.26	21.29	21.64
			1	37	22.50	21.27	21.62	22.13
			1	74	22.50	21.01	21.45	22.18
			36	0	21.50	20.37	20.50	21.03
			36	18	21.50	20.29	20.67	21.12
			36	37	21.50	20.11	20.69	21.30
			75	0	21.50	20.24	20.62	21.18

Band	Band Width	Modulation	RB Configuration		Tune-up (dBm)	Channel/Frequency(MHz)		
			RB Size	RB Offset		18700/1860	18900/1880	19100/1900
		16QAM	1	0	21.50	20.66	20.63	20.82
			1	37	21.50	20.64	21.01	21.43
			1	74	21.50	20.22	20.67	21.42
			36	0	20.50	19.38	19.54	20.06
			36	18	20.50	19.31	19.71	20.13
			36	37	20.50	19.17	19.72	20.28
			75	0	20.50	19.32	19.68	20.21
LTE Band 2	20MHz	QPSK	1	0	22.50	21.11	21.07	21.42
			1	49	22.50	21.31	21.69	22.06
			1	99	22.50	20.98	21.27	22.04
			50	0	21.50	20.43	20.42	21.09
			50	24	21.50	20.27	20.65	21.02
			50	49	21.50	20.09	20.78	21.18
			100	0	21.50	20.29	20.64	21.12
		16QAM	1	0	21.50	20.47	20.29	20.64
			1	49	21.50	20.56	20.95	21.36
			1	99	21.50	20.23	20.49	21.38
			50	0	20.50	19.50	19.49	20.12
			50	24	20.50	19.34	19.71	20.05
			50	49	20.50	19.16	19.81	20.22
			100	0	20.50	19.36	19.67	20.11

Band	Band Width	Modulation	RB Configuration		Tune-up (dBm)	Channel/Frequency(MHz)		
			RB Size	RB Offset		19957/1710.7	20175/1732.5	20393/1754.3
LTE Band 4	1.4MHz	QPSK	1	0	22.00	21.42	21.30	21.40
			1	2	22.00	21.50	21.38	21.53
			1	5	22.00	21.34	21.28	21.39
			3	0	22.00	21.50	21.38	21.47
			3	1	22.00	21.49	21.39	21.49
			3	2	22.00	21.47	21.36	21.47
			6	0	21.00	20.50	20.44	20.52
		16QAM	1	0	21.00	20.76	20.65	20.77
			1	2	21.00	20.93	20.74	20.80
			1	5	21.00	20.76	20.59	20.69
			3	0	21.00	20.59	20.35	20.50

Band	Band Width	Modulation	RB Configuration		Tune-up (dBm)	Channel/Frequency(MHz)		
			RB Size	RB Offset		19965/1711.5	20175/1732.5	20385/1753.5
			3	1	21.00	20.57	20.38	20.59
			3	2	21.00	20.51	20.47	20.58
			6	0	20.00	19.65	19.56	19.66
LTE Band 4	3MHz	QPSK	1	0	22.00	21.56	21.39	21.47
			1	7	22.00	21.48	21.40	21.54
			1	14	22.00	21.39	21.43	21.54
			8	0	21.00	20.56	20.50	20.58
			8	4	21.00	20.54	20.52	20.62
			8	7	21.00	20.49	20.54	20.59
		16QAM	15	0	21.00	20.50	20.52	20.58
			1	0	21.00	20.98	20.76	20.78
			1	7	21.00	20.91	20.68	20.79
			1	14	21.00	20.71	20.81	20.79
			8	0	20.00	19.65	19.56	19.68
			8	4	20.00	19.61	19.62	19.72
			8	7	20.00	19.59	19.61	19.67
			15	0	20.00	19.54	19.52	19.63
Band	Band Width	Modulation	RB Configuration		Tune-up (dBm)	Channel/Frequency(MHz)		
			RB Size	RB Offset		19975/1712.5	20175/1732.5	20375/1752.5
LTE Band 4	5MHz	QPSK	1	0	21.50	21.33	21.19	21.28
			1	12	21.50	21.37	21.37	21.43
			1	24	21.50	21.16	21.25	21.36
			12	0	21.00	20.42	20.40	20.46
			12	6	21.00	20.44	20.49	20.53
			12	11	21.00	20.32	20.42	20.49
		16QAM	25	0	21.00	20.35	20.40	20.50
			1	0	21.00	20.67	20.43	20.62
			1	12	21.00	20.79	20.66	20.81
			1	24	21.00	20.46	20.55	20.67
			12	0	20.00	19.46	19.38	19.50
			12	6	20.00	19.43	19.51	19.59
			12	11	20.00	19.36	19.41	19.49
			25	0	20.00	19.40	19.43	19.54
Band	Band Width	Modulation	RB Configuration		Tune-up (dBm)	Channel/Frequency(MHz)		
			RB Size	RB Offset		20000/1715	20175/1732.5	20350/1750

LTE Band 4	10MHz	QPSK	1	0	22.00	21.42	21.24	21.32
			1	24	22.00	21.37	21.51	21.56
			1	49	22.00	21.15	21.33	21.42
			25	0	21.00	20.40	20.45	20.59
			25	12	21.00	20.38	20.50	20.54
			25	24	21.00	20.38	20.45	20.53
		16QAM	50	0	21.00	20.42	20.46	20.58
			1	0	21.00	20.74	20.60	20.67
			1	24	21.00	20.78	20.73	20.84
			1	49	21.00	20.61	20.63	20.78
			25	0	20.00	19.44	19.49	19.62
			25	12	20.00	19.41	19.53	19.58
			25	24	20.00	19.44	19.48	19.57
			50	0	20.00	19.44	19.48	19.61
Band	Band Width	Modulation	RB Configuration		Tune-up (dBm)	Channel/Frequency(MHz)		
			RB Size	RB Offset		20025/1717.5	20175/1732.5	20325/1747.5
LTE Band 4	15MHz	QPSK	1	0	21.50	21.26	21.05	21.17
			1	37	21.50	21.21	21.36	21.39
			1	74	21.50	21.06	21.20	21.28
			36	0	21.00	20.31	20.30	20.54
			36	18	21.00	20.31	20.44	20.49
			36	37	21.00	20.33	20.42	20.42
		16QAM	75	0	20.50	20.30	20.35	20.49
			1	0	21.00	20.68	20.34	20.44
			1	37	21.00	20.55	20.65	20.67
			1	74	21.00	20.39	20.48	20.71
			36	0	20.00	19.29	19.30	19.53
			36	18	20.00	19.31	19.43	19.50
			36	37	20.00	19.33	19.38	19.44
			75	0	20.00	19.35	19.36	19.51
Band	Band Width	Modulation	RB Configuration		Tune-up (dBm)	Channel/Frequency(MHz)		
			RB Size	RB Offset		20050/1720	20175/1732.5	20300/1745
LTE Band 4	20MHz	QPSK	1	0	21.50	21.08	20.85	21.03
			1	49	21.50	21.23	21.44	21.46
			1	99	21.50	20.97	21.10	21.13
			50	0	21.00	20.16	20.25	20.65
			50	24	21.00	20.24	20.44	20.48
			50	49	21.00	20.43	20.37	20.38

			100	0	21.00	20.33	20.30	20.55
		16QAM	1	0	21.00	20.35	20.17	20.33
			1	49	21.00	20.64	20.68	20.84
			1	99	21.00	20.33	20.35	20.43
			50	0	20.00	19.20	19.28	19.67
			50	24	20.00	19.29	19.44	19.51
			50	49	20.00	19.47	19.38	19.41
			100	0	20.00	19.35	19.30	19.55

Band	Band Width	Modulation	RB Configuration		Tune-up (dBm)	Channel/Frequency(MHz)		
			RB Size	RB Offset		20407/824.7	20525/836.5	20643/848.3
LTE Band 5	1.4MHz	QPSK	1	0	23.50	23.16	23.03	23.10
			1	2	23.50	23.21	23.12	23.23
			1	5	23.50	23.09	23.03	23.08
			3	0	23.50	23.22	23.12	23.19
			3	1	23.50	23.22	23.13	23.20
			3	2	23.50	23.20	23.09	23.17
		16QAM	6	0	22.50	22.18	22.09	22.17
			1	0	22.50	22.39	22.37	22.43
			1	2	22.50	22.36	22.35	22.46
			1	5	22.50	22.36	22.25	22.38
			3	0	22.50	22.18	22.09	22.05
			3	1	22.50	22.22	22.14	22.05
			3	2	22.50	22.20	22.15	22.07
			6	0	21.50	21.23	21.21	21.13

Band	Band Width	Modulation	RB Configuration		Tune-up (dBm)	Channel/Frequency(MHz)		
			RB Size	RB Offset		20415/825.5	20525/836.5	20635/847.5
LTE Band 5	3MHz	QPSK	1	0	23.50	22.94	23.09	23.29
			1	7	23.50	22.76	23.12	23.01
			1	14	23.50	23.07	23.16	23.13
			8	0	22.50	22.21	22.15	21.96
			8	4	22.50	22.19	22.17	21.98
			8	7	22.50	22.14	22.15	21.97
			15	0	22.50	22.16	22.11	21.98
		16QAM	1	0	23.00	22.52	22.34	22.12
			1	7	23.00	22.51	22.39	22.05
			1	14	23.00	22.41	22.44	21.94
			8	0	21.50	21.30	21.21	20.93

Band	Band Width	Modulation	RB Configuration		Tune-up (dBm)	Channel/Frequency(MHz)		
			RB Size	RB Offset		20425/826.5	20525/836.5	20625/846.5
			8	4	21.50	21.25	21.25	20.99
			8	7	21.50	21.20	21.23	20.94
			15	0	21.50	21.19	21.15	20.98
LTE Band 5	5MHz	QPSK	1	0	23.50	22.62	22.79	23.05
			1	12	23.50	22.60	22.67	22.84
			1	24	23.50	22.55	22.93	22.85
			12	0	22.00	21.75	21.81	21.97
			12	6	22.00	21.90	21.94	21.99
			12	11	22.00	21.75	21.86	21.76
		16QAM	25	0	22.00	21.81	21.88	21.74
			1	0	22.50	21.85	22.11	22.00
			1	12	22.50	22.25	22.24	22.08
			1	24	22.50	21.85	22.16	21.96
			12	0	21.50	20.91	20.92	21.02
			12	6	21.50	21.07	21.01	20.95
			12	11	21.50	20.96	21.07	20.99
			25	0	21.50	21.06	21.03	21.04
LTE Band 5	10MHz	QPSK	1	0	23.50	22.81	22.66	22.96
			1	24	23.50	22.72	22.69	23.03
1	49		23.50	22.65	22.85	22.91		
25	0		22.50	21.83	21.88	21.95		
25	12		22.50	21.76	21.96	22.17		
25	24		22.50	21.76	22.01	21.98		
50	0		22.50	21.88	21.96	22.12		
16QAM	1	0	23.00	21.99	21.91	22.22		
	1	24	23.00	22.21	22.16	22.60		
	1	49	23.00	22.03	22.09	22.27		
	25	0	21.50	20.88	20.81	20.95		
	25	12	21.50	20.87	21.10	21.17		
	25	24	21.50	21.00	21.16	21.08		
	50	0	21.50	21.01	21.06	21.25		

Band	Band Width	Modulation	RB Configuration		Tune-up (dBm)	Channel/Frequency(MHz)		
			RB Size	RB Offset		20775/2502.5	21100/2535	21425/2567.5
LTE Band 7	5MHz	QPSK	1	0	24.00	23.55	22.60	22.64
			1	12	24.00	23.60	22.74	22.81
			1	24	24.00	23.02	22.65	22.68
			12	0	22.50	22.19	21.72	21.79
			12	6	22.50	22.20	21.78	21.84
			12	11	22.50	22.15	21.71	21.75
			25	0	22.50	22.17	21.71	21.79
		16QAM	1	0	22.50	22.23	21.76	21.93
			1	12	22.50	22.22	21.94	22.04
			1	24	22.50	22.11	21.90	21.88
			12	0	21.50	21.15	20.68	20.73
			12	6	21.50	21.16	20.72	20.77
			12	11	21.50	21.10	20.67	20.70
			25	0	21.50	21.14	20.70	20.75
Band	Band Width	Modulation	RB Configuration		Tune-up (dBm)	Channel/Frequency(MHz)		
			RB Size	RB Offset		20800/2505	21100/2535	21400/2565
LTE Band 7	10MHz	QPSK	1	0	23.50	23.11	22.67	22.56
			1	24	23.50	23.23	22.89	22.85
			1	49	23.50	23.05	22.75	22.71
			25	0	22.50	22.25	21.86	21.76
			25	12	22.50	22.23	21.85	21.84
			25	24	22.50	22.16	21.81	21.83
			50	0	22.50	22.21	21.85	21.81
		16QAM	1	0	22.50	22.34	21.88	21.81
			1	24	22.50	22.37	22.10	22.05
			1	49	22.50	22.15	21.96	21.92
			25	0	21.50	21.24	20.83	20.73
			25	12	21.50	21.19	20.80	20.79
			25	24	21.50	21.13	20.76	20.80
			50	0	21.50	21.18	20.79	20.77
Band	Band Width	Modulation	RB Configuration		Tune-up (dBm)	Channel/Frequency(MHz)		
			RB Size	RB Offset		20825/2507.5	21100/2535	21375/2562.5
LTE Band 7	15MHz	QPSK	1	0	23.50	23.01	22.56	22.34
			1	37	23.50	23.11	22.79	22.66



Band	Band Width	Modulation	RB Configuration		Tune-up (dBm)	Channel/Frequency(MHz)					
			RB Size	RB Offset		20850/2510	21100/2535	21350/2560			
			1	74	23.50	22.91	22.61	22.55			
			36	0	22.50	22.19	21.76	21.52			
			36	18	22.50	22.18	21.80	21.69			
			36	37	22.50	22.16	21.77	21.69			
			75	0	22.50	22.17	21.74	21.62			
		16QAM	1	0	22.50	22.27	21.75	21.57			
			1	37	22.50	22.33	21.99	21.81			
			1	74	22.50	22.06	21.91	21.75			
			36	0	21.50	21.13	20.69	20.48			
			36	18	21.50	21.12	20.72	20.63			
			36	37	21.50	21.09	20.69	20.64			
			75	0	21.50	21.11	20.70	20.58			
			LTE Band 7	20MHz	QPSK	1	0	23.50	22.83	22.53	22.27
						1	49	23.50	23.12	22.78	22.59
1	99	23.50				22.65	22.42	22.41			
50	0	22.50				22.22	21.82	21.57			
50	24	22.50				22.21	21.84	21.59			
50	49	22.50				22.17	21.71	21.68			
100	0	22.50				22.17	21.73	21.59			
16QAM	1	0			22.50	22.09	21.64	21.48			
	1	49			22.50	22.33	22.07	21.76			
	1	99			22.50	21.82	21.63	21.66			
	50	0			21.50	21.19	20.80	20.54			
	50	24			21.50	21.16	20.77	20.55			
	50	49			21.50	21.15	20.67	20.64			
	100	0			21.50	21.13	20.69	20.56			

Band	Band Width	Modulation	RB Configuration		Tune-up (dBm)	Channel/Frequency(MHz)		
			RB Size	RB Offset		23017/699.7	23095/707.5	23173/715.3
LTE Band 12	1.4MHz	QPSK	1	0	24.50	24.21	24.15	23.99
			1	2	24.50	24.30	24.21	24.09
			1	5	24.50	24.18	24.11	23.94
			3	0	24.50	24.27	24.22	24.08
			3	1	24.50	24.29	24.24	24.06
			3	2	24.50	24.26	24.20	24.03
			6	0	23.50	23.30	23.25	23.10

		16QAM	1	0	24.00	23.33	23.40	23.28
			1	2	24.00	23.52	23.42	23.25
			1	5	24.00	23.36	23.30	23.18
			3	0	23.50	23.23	23.16	23.09
			3	1	23.50	23.22	23.25	23.00
			3	2	23.50	23.20	23.12	23.06
			6	0	22.50	22.35	22.31	22.17
Band	Band Width	Modulation	RB Configuration		Tune-up (dBm)	Channel/Frequency(MHz)		
			RB Size	RB Offset		23025/700.5	23095/707.5	23165/714.5
LTE Band 12	3MHz	QPSK	1	0	24.50	24.20	24.21	24.12
			1	7	24.50	24.19	24.17	24.05
			1	14	24.50	24.21	24.15	24.01
			8	0	23.50	23.24	23.25	23.17
			8	4	23.50	23.27	23.27	23.16
			8	7	23.50	23.24	23.21	23.12
			15	0	23.50	23.26	23.24	23.15
		16QAM	1	0	23.50	23.45	23.43	23.32
			1	7	23.50	23.39	23.33	23.25
			1	14	23.50	23.43	23.41	23.23
			8	0	22.50	22.28	22.25	22.22
			8	4	22.50	22.34	22.32	22.21
			8	7	22.50	22.25	22.25	22.11
			15	0	22.50	22.22	22.22	22.13
Band	Band Width	Modulation	RB Configuration		Tune-up (dBm)	Channel/Frequency(MHz)		
			RB Size	RB Offset		23035/701.5	23095/707.5	23155/713.5
LTE Band 12	5MHz	QPSK	1	0	24.50	23.96	24.03	23.92
			1	12	24.50	24.11	24.08	23.98
			1	24	24.50	24.01	23.92	23.78
			12	0	23.50	23.13	23.13	23.09
			12	6	23.50	23.21	23.17	23.10
			12	11	23.50	23.13	23.08	22.96
			25	0	23.50	23.15	23.09	23.03
		16QAM	1	0	23.50	23.12	23.33	23.19
			1	12	23.50	23.35	23.31	23.20
			1	24	23.50	23.24	23.11	23.10
			12	0	22.50	22.10	22.06	22.01
			12	6	22.50	22.16	22.14	22.08
			12	11	22.50	22.09	22.04	21.92

Band	Band Width	Modulation	RB Configuration		Tune-up (dBm)	Channel/Frequency(MHz)		
			RB Size	RB Offset		23060/704	23095/707.5	23130/711
			25	0				
LTE Band 12	10MHz	QPSK	1	0	24.50	24.03	24.07	24.06
			1	24	24.50	24.25	24.16	24.12
			1	49	24.50	23.96	23.94	23.84
			25	0	23.50	23.23	23.20	23.22
			25	12	23.50	23.24	23.20	23.15
			25	24	23.50	23.22	23.11	23.01
			50	0	23.50	23.23	23.16	23.14
		16QAM	1	0	24.00	23.23	23.29	23.32
			1	24	24.00	23.51	23.42	23.32
			1	49	24.00	23.19	23.20	23.04
			25	0	22.50	22.21	22.16	22.18
			25	12	22.50	22.22	22.17	22.14
			25	24	22.50	22.20	22.06	22.01
			50	0	22.50	22.19	22.11	22.10

Band	Band Width	Modulation	RB Configuration		Tune-up (dBm)	Channel/Frequency(MHz)		
			RB Size	RB Offset		23755/706.5	23790/710	23825/713.5
LTE Band 17	5MHz	QPSK	1	0	24.50	24.11	24.06	23.95
			1	12	24.50	24.17	24.08	24.02
			1	24	24.50	24.02	23.93	23.87
			12	0	23.50	23.27	23.19	23.09
			12	6	23.50	23.28	23.18	23.16
			12	11	23.50	23.20	23.08	23.04
			25	0	23.50	23.22	23.14	23.06
		16QAM	1	0	23.50	23.26	23.32	23.24
			1	12	23.50	23.37	23.32	23.23
			1	24	23.50	23.23	23.08	23.04
			12	0	22.50	22.23	22.15	22.03
			12	6	22.50	22.25	22.16	22.15
			12	11	22.50	22.13	22.06	21.99
			25	0	22.50	22.20	22.13	22.04
Band	Band Width	Modulation	RB Configuration		Tune-up (dBm)	Channel/Frequency(MHz)		
			RB Size	RB Offset		23780/709	23790/710	23800/711
LTE	10MHz	QPSK	1	0	24.50	24.12	24.10	23.86

Band 17		1	24	24.50	24.07	23.87	23.71
		1	49	24.50	23.94	23.84	23.64
		25	0	23.50	23.18	22.99	22.94
		25	12	23.50	23.19	23.04	22.92
		25	24	23.50	23.13	23.05	22.96
		50	0	23.50	23.20	23.07	22.82
	16QAM	1	0	23.50	23.34	23.33	22.98
		1	24	23.50	23.42	23.19	22.98
		1	49	23.50	23.08	22.92	22.76
		25	0	22.50	22.10	22.11	21.82
		25	12	22.50	22.21	21.99	21.80
		25	24	22.50	22.08	22.02	21.79
		50	0	22.50	22.15	22.17	21.89

Band	Band Width	Modulation	RB Configuration		Tune-up (dBm)	Channel/Frequency(MHz)		
			RB Size	RB Offset		40115	40640	41165
LTE Band 41	5MHz	QPSK	1	0	23.50	23.12	23.27	22.92
			1	12	23.50	23.22	23.47	22.98
			1	24	23.50	23.09	23.44	22.89
			12	0	22.50	22.22	22.37	21.96
			12	6	22.50	22.26	22.45	21.98
			12	11	22.50	22.19	22.44	21.91
		16QAM	25	0	22.50	22.2	22.4	21.94
			1	0	23.00	22.27	22.42	22.06
			1	12	23.00	22.39	22.65	22.16
			1	24	23.00	22.24	22.61	22.06
			12	0	21.50	21.2	21.35	20.97
			12	6	21.50	21.19	21.43	20.99
			12	11	21.50	21.14	21.41	20.92
			25	0	21.50	21.19	21.41	20.99
Band	Band Width	Modulation	RB Configuration		Tune-up (dBm)	Channel/Frequency(MHz)		
			RB Size	RB Offset		40140	40640	41140
LTE Band 41	10MHz	QPSK	1	0	24.00	23.22	23.19	23.13
			1	24	24.00	23.34	23.59	23.13
			1	49	24.00	23.01	23.52	22.93
			25	0	23.00	22.35	22.46	22.15
			25	12	23.00	22.25	22.5	22.07
			25	24	23.00	22.2	22.5	22.01



			50	49	22.00	20.92	21.46	20.97
			100	0	21.50	21.09	21.36	21.23

Band	Band Width	Modulation	RB Configuration		Tune-up (dBm)	Channel/Frequency(MHz)		
			RB Size	RB Offset		131979/1710.7	132322/1745	132665/1779.3
LTE Band 66	1.4MHz	QPSK	1	0	22.50	21.51	21.36	21.94
			1	2	22.50	21.59	21.51	22.08
			1	5	22.50	21.44	21.35	21.97
			3	0	22.50	21.61	21.43	22.04
			3	1	22.50	21.57	21.45	22.06
			3	2	22.50	21.59	21.44	22.06
			6	0	21.50	20.59	20.51	21.06
		16QAM	1	0	21.50	20.80	20.69	21.29
			1	2	21.50	20.88	20.68	21.42
			1	5	21.50	20.72	20.63	21.29
			3	0	21.50	20.66	20.47	21.06
			3	1	21.50	20.63	20.55	21.10
			3	2	21.50	20.60	20.50	21.09
			6	0	20.50	19.72	19.60	20.17
Band	Band Width	Modulation	RB Configuration		Tune-up (dBm)	Channel/Frequency(MHz)		
			RB Size	RB Offset		131987/1711.5	132322/1745	132657/1778.5
LTE Band 66	3MHz	QPSK	1	0	22.50	21.59	21.48	22.07
			1	7	22.50	21.53	21.50	22.08
			1	14	22.50	21.48	21.46	22.09
			8	0	21.50	20.60	20.52	21.11
			8	4	21.50	20.60	20.55	21.16
			8	7	21.50	20.57	20.52	21.11
			15	0	21.50	20.57	20.55	21.12
		16QAM	1	0	21.50	20.92	20.84	21.41
			1	7	21.50	20.94	20.85	21.41
			1	14	21.50	20.81	20.80	21.38
			8	0	20.50	19.70	19.62	20.25
			8	4	20.50	19.70	19.66	20.26
			8	7	20.50	19.67	19.64	20.27
			15	0	20.50	19.60	19.59	20.19
Band	Band	Modulation	RB		Tune-up	Channel/Frequency(MHz)		

	Width		Configuration		(dBm)			
			RB Size	RB Offset		131997/1712.5	132322/1745	132647/1777.5
LTE Band 66	5MHz	QPSK	1	0	22.00	21.40	21.31	21.81
			1	12	22.00	21.41	21.41	22.00
			1	24	22.00	21.21	21.27	21.91
			12	0	21.50	20.46	20.48	21.08
			12	6	21.50	20.48	20.52	21.06
			12	11	21.50	20.35	20.39	20.95
			25	0	21.00	20.43	20.48	21.00
		16QAM	1	0	21.50	20.81	20.65	21.10
			1	12	21.50	20.84	20.74	21.22
			1	24	21.50	20.51	20.55	21.25
			12	0	20.50	19.47	19.50	20.12
			12	6	20.50	19.53	19.54	20.10
			12	11	20.50	19.39	19.40	19.99
			25	0	20.50	19.47	19.51	20.09
Band	Band Width	Modulation	RB Configuration		Tune-up (dBm)	Channel/Frequency(MHz)		
			RB Size	RB Offset		132022/1715	132322/1745	132622/1775
LTE Band 66	10MHz	QPSK	1	0	22.50	21.46	21.37	21.80
			1	24	22.50	21.38	21.51	22.07
			1	49	22.50	21.21	21.36	21.98
			25	0	21.50	20.46	20.63	21.06
			25	12	21.50	20.42	20.55	21.05
			25	24	21.50	20.43	20.48	20.95
			50	0	21.50	20.45	20.57	21.01
		16QAM	1	0	21.50	20.70	20.63	21.14
			1	24	21.50	20.80	20.79	21.37
			1	49	21.50	20.49	20.75	21.23
			25	0	20.50	19.50	19.65	20.12
			25	12	20.50	19.45	19.58	20.14
			25	24	20.50	19.44	19.53	20.03
			50	0	20.50	19.48	19.60	20.07
Band	Band Width	Modulation	RB Configuration		Tune-up (dBm)	Channel/Frequency(MHz)		
			RB Size	RB Offset		132047/1717.5	132322/1745	132597/1772.5
LTE	15MHz	QPSK	1	0	22.00	21.29	21.25	21.52

Band 66			1	37	22.00	21.27	21.41	21.86
			1	74	22.00	21.09	21.28	21.74
			36	0	21.00	20.35	20.58	20.75
			36	18	21.00	20.32	20.51	20.88
			36	37	21.00	20.32	20.42	20.83
			75	0	21.00	20.31	20.50	20.77
			75	37	21.00	20.32	20.42	20.83
		16QAM	1	0	21.50	20.73	20.52	20.80
			1	37	21.50	20.55	20.74	21.16
			1	74	21.50	20.52	20.69	21.02
			36	0	20.00	19.35	19.58	19.77
			36	18	20.00	19.31	19.50	19.91
			36	37	20.00	19.33	19.41	19.86
			75	0	20.00	19.35	19.52	19.84
Band	Band Width	Modulation	RB Configuration		Tune-up (dBm)	Channel/Frequency(MHz)		
			RB Size	RB Offset		132072/1720	132322/1745	132572/1770
LTE Band 66	20MHz	QPSK	1	0	22.00	21.13	21.05	21.25
			1	49	22.00	21.31	21.47	21.84
			1	99	22.00	20.99	21.15	21.61
			50	0	21.00	20.22	20.71	20.56
			50	24	21.00	20.23	20.53	20.79
			50	49	21.00	20.47	20.38	20.70
			100	0	21.00	20.31	20.57	20.61
		16QAM	1	0	21.50	20.48	20.45	20.66
			1	49	21.50	20.62	20.83	21.19
			1	99	21.50	20.36	20.60	20.95
			50	0	20.00	19.26	19.69	19.62
			50	24	20.00	19.28	19.54	19.88
			50	49	20.00	19.49	19.40	19.77
			100	0	20.00	19.34	19.57	19.68

#### 7.4. WLAN & Bluetooth Output Power

Mode	Channel	Frequency (MHz)	Tune-up (dBm)	Output Power (dBm)
802.11b	1	2412	12.50	11.44
	6	2437	12.50	12.21
	11	2462	12.50	12.25



802.11g	1	2412	11.50	11.16
	6	2437	11.50	11.45
	11	2462	11.50	11.00
802.11n HT20	1	2412	11.50	11.12
	6	2437	11.50	11.39
	11	2462	11.50	11.37
802.11n HT40	3	2422	11.000	10.10
	6	2437	11.000	10.71
	9	2452	11.000	10.65

NOTE: Power measurement results of WLAN 2.4G.

Mode	Channel	Frequency (MHz)	Tune-up (dBm)	Output Power (dBm)
802.11a	36	5180	5.5	3.91
	40	5200	5.5	4.46
	48	5240	5.5	5.41
802.11n HT20	36	5180	5	3.94
	40	5200	5	4.18
	48	5240	5	4.72
802.11n HT40	38	5190	5	3.86
	46	5230	5	4.76
802.11ac VHT20	36	5180	5	3.67
	40	5200	5	3.87
	48	5240	5	4.85
802.11ac VHT40	38	5190	5	3.9
	46	5230	5	4.51
802.11ac VHT80	42	5210	4.5	4.16

NOTE: Power measurement results of WLAN 5.2G.

Mode	Channel	Frequency (MHz)	Tune-up (dBm)	Output Power (dBm)
802.11a	149	5745	7.50	7.29
	157	5785	7.50	7.28
	165	5825	7.50	6.58
802.11n HT20	149	5745	7.50	7.31
	157	5785	7.50	7.09
	165	5825	7.50	6.41
802.11n HT40	151	5755	7.50	7.24
	159	5795	7.50	6.80
802.11ac VHT20	149	5745	7.50	7.47

	157	5785	7.50	7.08
	165	5825	7.50	6.43
802.11ac VHT40	151	5755	7.50	7.24
	159	5795	7.50	7.23
802.11ac VHT80	155	5775	7.50	7.09

NOTE: Power measurement results of WLAN 5.8G.

BR+EDR	Output Power (dBm)				
	Data Rates	Tune-up (dBm)	Channel		
			0CH	39CH	78CH
1M	8	6.31	6.39	7.12	
2M	7	5.54	5.52	6.30	
3M	7	5.49	5.43	6.19	

BLE	Output Power (dBm)				
	Data Rates	Tune-up (dBm)	Channe		
			0CH	19CH	39CH
1M	-6	-6.3	-6.31	-6.02	
2M	-6	-0.654	-6.31	-6.09	

NOTE: Power measurement results of Bluetooth.

### 7.5. NFC

The power is too low, so SAR testing is not necessary.

## 8. Antenna Location

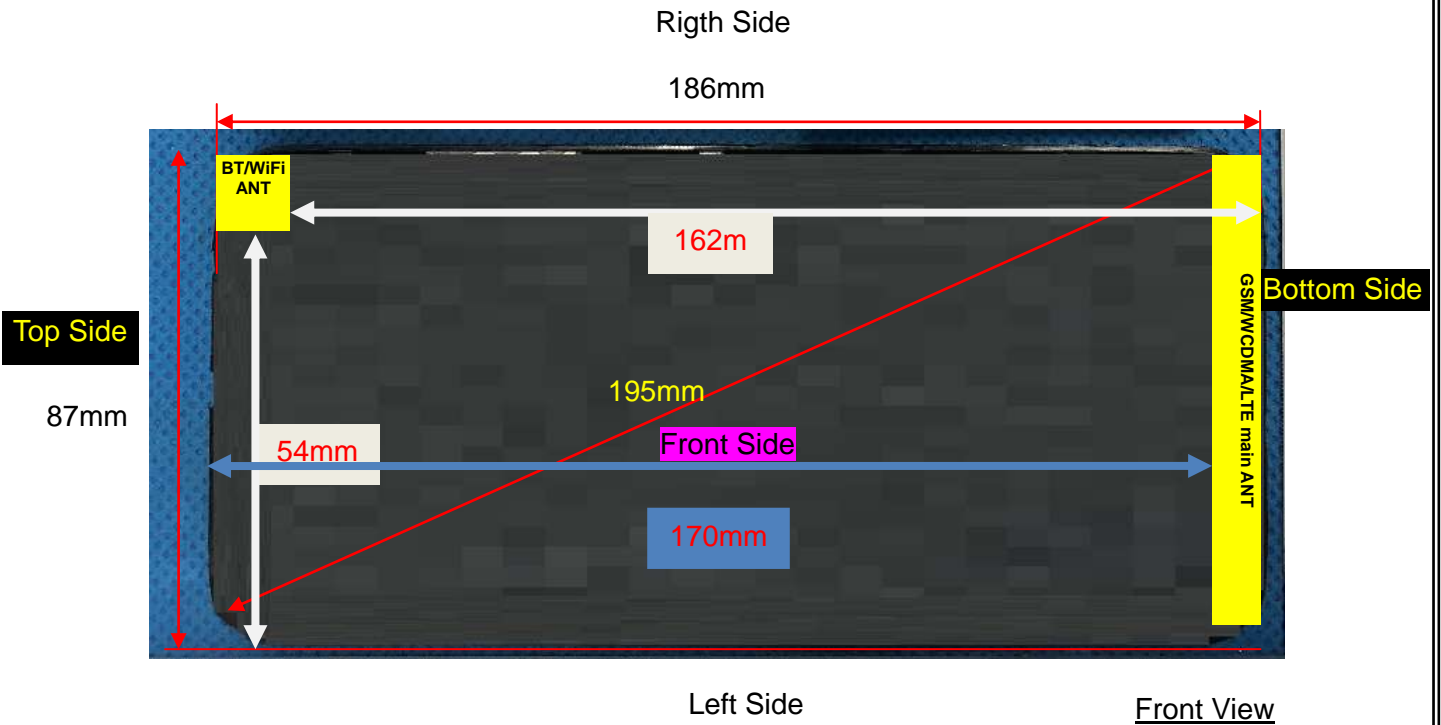

Note: Since the confidentiality request of EUT, the antenna location example diagram see as above.

Distance of the Antenna to the EUT surface/edge						
Antennas	Front Side	Back Side	Left Side	Right Side	Top Side	Bottom Side
WWAN Main ANT	≤ 25mm	≤ 25mm	≤ 25mm	>25mm	> 25mm	≤ 25mm
WLAN & Bluetooth	≤ 25mm	≤ 25mm	>25mm	≤ 25mm	≤ 25mm	>25mm
Positions for SAR tests						
Antennas	Front Side	Back Side	Left Side	Right Side	Top Side	Bottom Side
WWAN Main ANT	Yes	Yes	Yes	NO	NO	Yes
WLAN & Bluetooth	Yes	Yes	NO	Yes	Yes	NO

## 9. SAR Results

### 9.1. SAR measurement Result

#### 9.1.1. SAR measurement Result of GSM850

Test Position of Head	Test channel /Freq.	Mode	SAR Value (W/kg)		Power Drift(±5%)	Conducted Power (dBm)	Tune-up Power (dBm)	Scaled SAR 1-g (W/Kg)	Date	Plot
			1-g	10-g						
Left Cheek	189/836.4	GPRS(GMSK 4TS)	0.130	0.107	2.14	28.74	29.00	0.138	2024/10/10	1#
Left Tilt	189/836.4	GPRS(GMSK	0.071	0.058	-1.57	28.74	29.00	0.075	2024/10/10	

15 Degree		4TS)								
Right Cheek	189/836.4	GPRS(GMSK 4TS)	0.113	0.092	0.87	28.74	29.00	0.120	2024/10/10	
Right Tilt 15 Degree	189/836.4	GPRS(GMSK 4TS)	0.057	0.046	-1.93	28.74	29.00	0.061	2024/10/10	

NOTE: Head SAR test results of GSM850.

Test Position of Body-Worn with 10mm	Test channel /Freq.	Test Mode	SAR Value (W/kg)		Power Drift (±5%)	Conducted power (dBm)	Tune-up power (dBm)	Scaled SAR 1g (W/Kg)	Date	Plot
			1g	10g						
Front Side	189/836.4	GPRS(GMSK 4TS)	0.210	0.127	0.17	28.74	29.00	0.223	2024/10/10	
Back Side	189/836.4	GPRS(GMSK 4TS)	0.282	0.180	1.13	28.74	29.00	0.299	2024/10/10	2#

NOTE: Body-Worn SAR test results of GSM850

Test Position of Hotspot with 10mm	Test channel /Freq.	Test Mode	SAR Value (W/kg)		Power Drift (±5%)	Conducted power (dBm)	Tune-up power (dBm)	Scaled SAR 1g (W/Kg)	Date	Plot
			1-g	10-g						
Front Side	189/836.4	GPRS(GMSK 4TS)	0.210	0.127	0.17	28.74	29.00	0.223	2024/10/10	
Back Side	189/836.4	GPRS(GMSK 4TS)	0.282	0.180	1.13	28.74	29.00	0.299	2024/10/10	2#
Left Side	189/836.4	GPRS(GMSK 4TS)	0.135	0.083	0.34	28.74	29.00	0.143	2024/10/10	
Right Side	189/836.4	GPRS(GMSK 4TS)	0.215	0.137	2.23	28.74	29.00	0.228	2024/10/10	
Bottom Side	189/836.4	GPRS(GMSK 4TS)	0.116	0.073	0.73	28.74	29.00	0.123	2024/10/10	

NOTE: Hotspot SAR test results of GSM850

### 9.1.2. SAR measurement Result of GSM1900

Test Position of Head	Test channel /Freq.	Test Mode	SAR Value (W/kg)		Power Drift (±5%)	Conducted power (dBm)	Tune-up power (dBm)	Scaled SAR 1g	Date	Plot
			1-g	10-g						

								(W/Kg)		
Left Cheek	661/1880	GPRS(GMSK 4TS)	0.062	0.041	-1.82	23.89	24.50	0.071	2024/10/12	3#
Left Tilt 15 Degree	661/1880	GPRS(GMSK 4TS)	0.032	0.021	0.17	23.89	24.50	0.037	2024/10/12	
Right Cheek	661/1880	GPRS(GMSK 4TS)	0.053	0.035	-0.65	23.89	24.50	0.061	2024/10/12	
Right Tilt 15 Degree	661/1880	GPRS(GMSK 4TS)	0.025	0.016	-3.26	23.89	24.50	0.029	2024/10/12	

NOTE: Head SAR test results of GSM1900

Test Position of Body-Worn with 10mm	Test channel /Freq.	Test Mode	SAR Value (W/kg)		Power Drift (±5%)	Conducted power (dBm)	Tune-up power (dBm)	Scaled SAR 1g (W/Kg)	Date	Plot
			1g	10g						
Front Side	661/1880	GPRS(GMSK 4TS)	0.140	0.081	-0.84	23.89	24.50	0.161	2024/10/12	
Back Side	661/1880	GPRS(GMSK 4TS)	0.148	0.085	3.08	23.89	24.50	0.170	2024/10/12	4#

NOTE: Body-Worn SAR test results of GSM1900

Test Position of Hotspot with 10mm	Test channel /Freq.	Test Mode	SAR Value (W/kg)		Power Drift (±5%)	Conducted power (dBm)	Tune-up power (dBm)	Scale d SAR 1g (W/K g)	Date	Plot
			1-g	10-g						
Front Side	661/1880	GPRS(GMSK 4TS)	0.140	0.081	-0.84	23.89	24.50	0.161	2024/10/12	
Back Side	661/1880	GPRS(GMSK 4TS)	0.148	0.085	3.08	23.89	24.50	0.170	2024/10/12	4#
Left Side	661/1880	GPRS(GMSK 4TS)	0.260	0.151	-2.12	23.89	24.50	0.299	2024/10/12	
Right Side	661/1880	GPRS(GMSK 4TS)	0.058	0.033	-3.93	23.89	24.50	0.067	2024/10/12	
Bottom Side	661/1880	GPRS(GMSK 4TS)	0.196	0.110	-2.57	23.89	24.50	0.226	2024/10/12	

NOTE: Hotspot SAR test results of GSM1900

### 9.1.3. SAR measurement Result of WCDMA Band 2

Test Position of Head	Test channel /Freq	Test Mode	SAR Value (W/kg)		Power Drift (±5%)	Conducted power (dBm)	Tune-up power (dBm)	Scaled SAR 1g (W/Kg)	Date	Plot
			1-g	10-g						
Left Cheek	9400/1880	RMC12.2K	0.069	0.044	2.06	21.27	22.00	0.082	2024/10/12	5#
Left Tilt 15 Degree	9400/1880	RMC12.2K	0.040	0.025	3.11	21.27	22.00	0.047	2024/10/12	
Right Cheek	9400/1880	RMC12.2K	0.066	0.042	-1.98	21.27	22.00	0.078	2024/10/12	
Right Tilt 15 Degree	9400/1880	RMC12.2K	0.032	0.020	1.67	21.27	22.00	0.038	2024/10/12	

NOTE: Head SAR test results of WCDMA Band 2

Test Position of Body-Worn with 10mm	Test channel /Freq.	Test Mode	SAR Value (W/kg)		Power Drift (±5%)	Conducted power (dBm)	Tune-up power (dBm)	Scaled SAR 1g (W/Kg)	Date	Plot
			1g	10g						
Front Side	9400/1880	RMC12.2K	0.155	0.089	-2.66	21.27	22.00	0.183	2024/10/12	
Back Side	9400/1880	RMC12.2K	0.165	0.096	-2.90	21.27	22.00	0.195	2024/10/12	6#

NOTE: Body-Worn SAR test results of WCDMA Band 2

Test Position of Hotspot with 10mm	Test channel /Freq.	Test Mode	SAR Value (W/kg)		Power Drift (±5%)	Conducte d power (dBm)	Tune-up power (dBm)	Scaled SAR 1g (W/Kg )	Date	Plot
			1-g	10-g						
Front Side	9400/1880	RMC12.2K	0.155	0.089	-2.66	21.27	22.00	0.183	2024/10/12	
Back Side	9400/1880	RMC12.2K	0.165	0.096	-2.90	21.27	22.00	0.195	2024/10/12	6#
Left Side	9400/1880	RMC12.2K	0.286	0.168	0.14	21.27	22.00	0.338	2024/10/12	
Right Side	9400/1880	RMC12.2K	0.062	0.036	1.09	21.27	22.00	0.073	2024/10/12	
Bottom Side	9400/1880	RMC12.2K	0.210	0.123	1.01	21.27	22.00	0.248	2024/10/12	

NOTE: Hotspot SAR test results of WCDMA Band 2

#### 9.1.4. SAR measurement Result of WCDMA Band 4

Test Position of Head	Test channel /Freq	Test Mode	SAR Value (W/kg)		Power Drift (±5%)	Conducted power (dBm)	Tune-up power (dBm)	Scaled SAR 1g (W/Kg)	Date	Plot
			1-g	10-g						
Left Cheek	1413/1732.6	RMC12.2K	0.147	0.100	0.61	20.83	21.50	0.172	2024/9/13	7#
Left Tilt 15 Degree	1413/1732.6	RMC12.2K	0.086	0.057	-0.80	20.83	21.50	0.100	2024/9/13	
Right Cheek	1413/1732.6	RMC12.2K	0.134	0.089	-0.12	20.83	21.50	0.156	2024/9/13	
Right Tilt 15 Degree	1413/1732.6	RMC12.2K	0.062	0.040	-0.82	20.83	21.50	0.072	2024/9/13	

NOTE: Head SAR test results of WCDMA Band 4

Test Position of Body-Worn with 10mm	Test channel /Freq.	Test Mode	SAR Value (W/kg)		Power Drift (±5%)	Conducted power (dBm)	Tune-up power (dBm)	Scaled SAR 1g (W/Kg)	Date	Plot
			1g	10g						
Front Side	1413/1732.6	RMC12.2K	0.355	0.203	-3.21	20.83	21.50	0.414	2024/9/13	
Back Side	1413/1732.6	RMC12.2K	0.405	0.243	0.44	20.83	21.50	0.473	2024/9/13	8#

NOTE: Body-Worn SAR test results of WCDMA Band 4

Test Position of Hotspot with 10mm	Test channel /Freq.	Test Mode	SAR Value (W/kg)		Power Drift (±5%)	Conducted power (dBm)	Tune-up power (dBm)	Scaled SAR 1g (W/Kg)	Date	Plot
			1-g	10-g						
Front Side	1413/1732.6	RMC12.2K	0.355	0.203	-3.21	20.83	21.50	0.414	2024/9/13	
Back Side	1413/1732.6	RMC12.2K	0.405	0.243	0.44	20.83	21.50	0.473	2024/9/13	8#
Left Side	1413/1732.6	RMC12.2K	0.674	0.405	-0.21	20.83	21.50	0.786	2024/9/13	
Right	1413/1732.6	RMC12.2K	0.138	0.079	-2.36	20.83	21.50	0.161	2024/9/13	

Side										
Bottom Side	1413/1732.6	RMC12.2K	0.483	0.284	2.57	20.83	21.50	0.564	2024/9/13	

NOTE: Hotspot SAR test results of WCDMA Band 4

### 9.1.5. SAR measurement Result of WCDMA Band 5

Test Position of Head	Test channel /Freq	Test Mode	SAR Value (W/kg)		Power Drift (±5%)	Conducted power (dBm)	Tune-up power (dBm)	Scaled SAR 1g (W/Kg)	Date	Plot
			1-g	10-g						
Left Cheek	4182/836.4	RMC12.2K	0.130	0.121	-0.60	22.38	22.50	0.134	2024/10/10	9#
Left Tilt 15 Degree	4182/836.4	RMC12.2K	0.068	0.063	3.52	22.38	22.50	0.070	2024/10/10	
Right Cheek	4182/836.4	RMC12.2K	0.113	0.102	0.77	22.38	22.50	0.116	2024/10/10	
Right Tilt 15 Degree	4182/836.4	RMC12.2K	0.062	0.055	3.62	22.38	22.50	0.064	2024/10/10	

NOTE: Head SAR test results of WCDMA Band 5

Test Position of Body-Worn with 10mm	Test channel /Freq.	Test Mode	SAR Value (W/kg)		Power Drift (±5%)	Conducted power (dBm)	Tune-up power (dBm)	Scaled SAR 1g (W/Kg)	Date	Plot
			1g	10g						
Front Side	4182/836.4	RMC12.2K	0.215	0.161	-0.40	22.38	22.50	0.221	2024/10/10	
Back Side	4182/836.4	RMC12.2K	0.264	0.163	-0.94	22.38	22.50	0.271	2024/10/10	10#

NOTE: Body-Worn SAR test results of WCDMA Band 5

Test Position of Hotspot with 10mm	Test channel /Freq.	Test Mode	SAR Value (W/kg)		Power Drift (±5%)	Conducted power (dBm)	Tune-up power (dBm)	Scaled SAR 1g (W/Kg)	Date	Plot
			1-g	10-g						
Front Side	4182/836.4	RMC12.2K	0.215	0.161	-0.40	22.38	22.50	0.221	2024/10/10	
Back Side	4182/836.4	RMC12.2K	0.264	0.163	-0.94	22.38	22.50	0.271	2024/10/10	10#
Left Side	4182/836.4	RMC12.2K	0.145	0.106	3.40	22.38	22.50	0.149	2024/10/10	
Right	4182/836.4	RMC12.2K	0.198	0.144	-2.00	22.38	22.50	0.204	2024/10/10	



Side										
Bottom Side	4182/836.4	RMC12.2K	0.128	0.093	1.70	22.38	22.50	0.132	2024/10/10	

NOTE: Hotspot SAR test results of WCDMA Band 5

**9.1.6. SAR measurement Result of LTE Band 2**

Test Position of Head	Test channel /Freq.	Test Mode	SAR Value (W/kg)		Power Drift (±5%)	Conducted power (dBm)	Tune-up power (dBm)	Scaled SAR 1g (W/Kg)	Date	Plot
			1-g	10-g						
1RB										
Left Cheek	18900/1880	20M QPSK(1,24)	0.053	0.034	4.76	21.69	22.50	0.064	2024/10/12	19#
Left Tilt 15 Degree	18900/1880	20M QPSK(1,24)	0.027	0.017	3.65	21.69	22.50	0.033	2024/10/12	
Right Cheek	18900/1880	20M QPSK(1,24)	0.050	0.031	0.99	21.69	22.50	0.060	2024/10/12	
Right Tilt 15 Degree	18900/1880	20M QPSK(1,24)	0.025	0.016	-1.25	21.69	22.50	0.030	2024/10/12	
50%RB										
Left Cheek	18900/1880	20M QPSK(50,49)	0.049	0.03	1.93	20.78	21.50	0.058	2024/10/12	
Left Tilt 15 Degree	18900/1880	20M QPSK(50,49)	0.025	0.016	-2.06	20.78	21.50	0.030	2024/10/12	
Right Cheek	18900/1880	20M QPSK(50,49)	0.045	0.027	-0.04	20.78	21.50	0.053	2024/10/12	
Right Tilt 15 Degree	18900/1880	20M QPSK(50,49)	0.022	0.014	-0.49	20.78	21.50	0.026	2024/10/12	

NOTE: Head SAR test results of LTE Band 2

Test Position of Body-Worn with 10mm	Test channel /Freq.	Test Mode	SAR Value (W/kg)		Power Drift (±5%)	Conducted power (dBm)	Tune-up power (dBm)	Scaled SAR 1g (W/Kg)	Date	Plot
			1g	10g						

1RB										
Front Side	18900/1880	20M QPSK(1,24)	0.130	0.078	1.62	21.69	22.50	0.157	2024/10/12	
Back Side	18900/1880	20M QPSK(1,24)	0.393	0.237	-2.46	21.69	22.50	0.474	2024/10/12	20#
50%RB										
Front Side	18900/1880	20M QPSK(50,49)	0.117	0.072	4.16	20.78	21.50	0.138	2024/10/12	
Back Side	18900/1880	20M QPSK(50,49)	0.34	0.203	0.36	20.78	21.50	0.401	2024/10/12	

NOTE: Body-Worn SAR test results of LTE Band 2

Test Position of Hotspot with 10mm	Test channel /Freq.	Test Mode	SAR Value (W/kg)		Power Drift (±5%)	Conducted power (dBm)	Tune-up power (dBm)	Scaled SAR 1g (W/Kg)	Date	Plot
			1-g	10-g						
1RB										
Front Side	18900/1880	20M QPSK(1,24)	0.130	0.078	1.62	21.69	22.50	0.157	2024/10/12	
Back Side	18900/1880	20M QPSK(1,24)	0.393	0.237	-2.46	21.69	22.50	0.474	2024/10/12	20#
Left Side	18900/1880	20M QPSK(1,24)	0.131	0.076	2.33	21.69	22.50	0.158	2024/10/12	
Right Side	18900/1880	20M QPSK(1,24)	0.048	0.029	2.48	21.69	22.50	0.058	2024/10/12	
Bottom Side	18900/1880	20M QPSK(1,24)	0.182	0.109	1.93	21.69	22.50	0.219	2024/10/12	
50%RB										
Front Side	18900/1880	20M QPSK(50,49)	0.117	0.072	4.16	20.78	21.50	0.138	2024/10/12	
Back Side	18900/1880	20M QPSK(50,49)	0.34	0.203	0.36	20.78	21.50	0.401	2024/10/12	
Left Side	18900/1880	20M QPSK(50,49)	0.123	0.066	2.37	20.78	21.50	0.145	2024/10/12	
Right Side	18900/1880	20M QPSK(50,49)	0.042	0.027	-4.17	20.78	21.50	0.050	2024/10/12	
Bottom Side	18900/1880	20M QPSK(50,49)	0.167	0.098	-1.13	20.78	21.50	0.197	2024/10/12	

NOTE: Hotspot SAR test results of LTE Band 2

**9.1.7. SAR measurement Result of LTE Band 4**

Test Position of Head	Test channel /Freq.	Test Mode	SAR Value (W/kg)		Power Drift (±5%)	Conducted power (dBm)	Tune-up power (dBm)	Scaled SAR 1g (W/Kg)	Date	Plot
			1-g	10-g						
1RB										
Left Cheek	20175/1732.5	20M QPSK(1,49)	0.108	0.071	4.86	21.44	21.50	0.110	2024/9/13	21#
Left Tilt 15 Degree	20175/1732.5	20M QPSK(1,49)	0.061	0.040	-0.51	21.44	21.50	0.062	2024/9/13	
Right Cheek	20175/1732.5	20M QPSK(1,49)	0.096	0.061	1.66	21.44	21.50	0.097	2024/9/13	
Right Tilt 15 Degree	20175/1732.5	20M QPSK(1,49)	0.048	0.031	0.69	21.44	21.50	0.049	2024/9/13	
50%RB										
Left Cheek	20175/1732.5	20M QPSK(50,0)	0.097	0.062	4.13	20.44	21.00	0.110	2024/9/13	
Left Tilt 15 Degree	20175/1732.5	20M QPSK(50,0)	0.057	0.036	-0.53	20.44	21.00	0.065	2024/9/13	
Right Cheek	20175/1732.5	20M QPSK(50,0)	0.086	0.055	-0.33	20.44	21.00	0.098	2024/9/13	
Right Tilt 15 Degree	20175/1732.5	20M QPSK(50,0)	0.043	0.027	3.81	20.44	21.00	0.049	2024/9/13	

NOTE: Head SAR test results of LTE Band 4

Test Position of Body-Worn with 10mm	Test channel /Freq.	Test Mode	SAR Value (W/kg)		Power Drift (±5%)	Conducted power (dBm)	Tune-up power (dBm)	Scaled SAR 1g (W/Kg)	Date	Plot
			1g	10g						
1RB										

Front Side	20175/1732.5	20M QPSK(1,49)	0.115	0.066	3.15	21.44	21.50	0.117	2024/9/13	
Back Side	20175/1732.5	20M QPSK(1,49)	0.148	0.089	1.59	21.44	21.50	0.150	2024/9/13	22#
50%RB										
Front Side	20175/1732.5	20M QPSK(50,0)	0.1	0.06	-3.77	20.44	21.00	0.114	2024/9/13	
Back Side	20175/1732.5	20M QPSK(50,0)	0.13	0.079	-4.69	20.44	21.00	0.148	2024/9/13	

NOTE: Body-Worn SAR test results of LTE Band 4

Test Position of Hotspot with 10mm	Test channel /Freq.	Test Mode	SAR Value (W/kg)		Power Drift (±5%)	Conducted power (dBm)	Tune-up power (dBm)	Scaled SAR 1g (W/Kg)	Date	Plot
			1-g	10-g						
1RB										
Front Side	20175/1732.5	20M QPSK(1,49)	0.115	0.066	3.15	21.44	21.50	0.117	2024/9/13	
Back Side	20175/1732.5	20M QPSK(1,49)	0.148	0.089	1.59	21.44	21.50	0.150	2024/9/13	22#
Left Side	20175/1732.5	20M QPSK(1,49)	0.227	0.137	-0.22	21.44	21.50	0.230	2024/9/13	
Right Side	20175/1732.5	20M QPSK(1,49)	0.050	0.030	2.35	21.44	21.50	0.051	2024/9/13	
Bottom Side	20175/1732.5	20M QPSK(1,49)	0.189	0.114	-0.40	21.44	21.50	0.192	2024/9/13	
50%RB										
Front Side	20175/1732.5	20M QPSK(50,0)	0.100	0.06	-3.77	20.44	21.00	0.114	2024/9/13	
Back Side	20175/1732.5	20M QPSK(50,0)	0.139	0.079	-4.69	20.44	21.00	0.158	2024/9/13	
Left Side	20175/1732.5	20M QPSK(50,0)	0.212	0.118	2.35	20.44	21.00	0.241	2024/9/13	
Right Side	20175/1732.5	20M QPSK(50,0)	0.047	0.027	2.54	20.44	21.00	0.053	2024/9/13	
Bottom Side	20175/1732.5	20M QPSK(50,0)	0.17	0.1	-0.52	20.44	21.00	0.193	2024/9/13	

NOTE: Hotspot SAR test results of LTE Band 4

### 9.1.8. SAR measurement Result of LTE Band 5

Test Position of Head	Test channel /Freq.	Test Mode	SAR Value (W/kg)		Power Drift (±5%)	Conducted power (dBm)	Tune-up power (dBm)	Scaled SAR 1g (W/Kg)	Date	Plot
			1-g	10-g						
1RB										
Left Cheek	20525/836.5	10M QPSK(1,49)	0.145	0.132	4.37	22.85	23.50	0.168	2024/10/10	23#
Left Tilt 15 Degree	20525/836.5	10M QPSK(1,49)	0.078	0.068	-1.04	22.85	23.50	0.091	2024/10/10	
Right Cheek	20525/836.5	10M QPSK(1,49)	0.132	0.117	2.1	22.85	23.50	0.153	2024/10/10	
Right Tilt 15 Degree	20525/836.5	10M QPSK(1,49)	0.065	0.058	1.85	22.85	23.50	0.075	2024/10/10	
50%RB										
Left Cheek	20525/836.5	10M QPSK(25,24)	0.124	0.116	-2.62	22.01	22.50	0.139	2024/10/10	
Left Tilt 15 Degree	20525/836.5	10M QPSK(25,24)	0.073	0.063	4.36	22.01	22.50	0.082	2024/10/10	
Right Cheek	20525/836.5	10M QPSK(25,24)	0.112	0.102	0.1	22.01	22.50	0.125	2024/10/10	
Right Tilt 15 Degree	20525/836.5	10M QPSK(25,24)	0.056	0.053	3.37	22.01	22.50	0.063	2024/10/10	

NOTE: Head SAR test results of LTE Band 5

Test Position of Body-Worn with 10mm	Test channel /Freq.	Test Mode	SAR Value (W/kg)		Power Drift (±5%)	Conducted power (dBm)	Tune-up power (dBm)	Scaled SAR 1g (W/Kg)	Date	Plot
			1g	10g						
1RB										
Front	20525/836.5	10M	0.247	0.180	-2.32	22.85	23.50	0.287	2024/10/10	

Side		QPSK(1,49)								
Back Side	20525/836.5	10M QPSK(1,49)	0.332	0.288	-0.59	22.85	23.50	0.386	2024/10/10	24#
50%RB										
Front Side	20525/836.5	10M QPSK(25,24)	0.22	0.155	-4.17	22.01	22.50	0.246	2024/10/10	
Back Side	20525/836.5	10M QPSK(25,24)	0.306	0.273	2.91	22.01	22.50	0.343	2024/10/10	

NOTE: Body-Worn SAR test results of LTE Band 5

Test Position of Hotspot with 10mm	Test channel /Freq.	Test Mode	SAR Value (W/kg)		Power Drift (±5%)	Conducted power (dBm)	Tune-up power (dBm)	Scaled SAR 1g (W/Kg)	Date	Plot
			1-g	10-g						
1RB										
Front Side	20525/836.5	10M QPSK(1,49)	0.247	0.180	-2.32	22.85	23.50	0.287	2024/10/10	
Back Side	20525/836.5	10M QPSK(1,49)	0.332	0.288	-0.59	22.85	23.50	0.386	2024/10/10	24#
Left Side	20525/836.5	10M QPSK(1,49)	0.101	0.074	1.34	22.85	23.50	0.117	2024/10/10	
Right Side	20525/836.5	10M QPSK(1,49)	0.193	0.142	-0.38	22.85	23.50	0.224	2024/10/10	
Bottom Side	20525/836.5	10M QPSK(1,49)	0.148	0.128	2.09	22.85	23.50	0.172	2024/10/10	
50%RB										
Front Side	20525/836.5	10M QPSK(25,24)	0.22	0.155	-4.17	22.01	22.50	0.246	2024/10/10	
Back Side	20525/836.5	10M QPSK(25,24)	0.306	0.273	2.91	22.01	22.50	0.343	2024/10/10	
Left Side	20525/836.5	10M QPSK(25,24)	0.087	0.069	2.24	22.01	22.50	0.097	2024/10/10	
Right Side	20525/836.5	10M QPSK(25,24)	0.165	0.121	-1.21	22.01	22.50	0.185	2024/10/10	
Bottom Side	20525/836.5	10M QPSK(25,24)	0.126	0.12	3.09	22.01	22.50	0.141	2024/10/10	

NOTE: Hotspot SAR test results of LTE Band 5

### 9.1.9. SAR measurement Result of LTE Band 7

Test Position of Head	Test channel /Freq.	Test Mode	SAR Value (W/kg)		Power Drift ( $\pm 5\%$ )	Conducted power (dBm)	Tune-up power (dBm)	Scaled SAR 1g (W/Kg)	Date	Plot
			1-g	10-g						
1RB										
Left Cheek	21100/2535	20M QPSK(1,49)	0.167	0.096	3.50	22.78	23.50	0.197	2024/10/13	25#
Left Tilt 15 Degree	21100/2535	20M QPSK(1,49)	0.096	0.052	5.82	22.78	23.50	0.113	2024/10/13	
Right Cheek	21100/2535	20M QPSK(1,49)	0.149	0.081	0.51	22.78	23.50	0.176	2024/10/13	
Right Tilt 15 Degree	21100/2535	20M QPSK(1,49)	0.073	0.042	4.98	22.78	23.50	0.086	2024/10/13	
50%RB										
Left Cheek	21100/2535	20M QPSK(50,24)	0.146	0.089	0.32	21.84	22.50	0.170	2024/10/13	
Left Tilt 15 Degree	21100/2535	20M QPSK(50,24)	0.09	0.044	1.79	21.84	22.50	0.105	2024/10/13	
Right Cheek	21100/2535	20M QPSK(50,24)	0.138	0.075	-1.37	21.84	22.50	0.161	2024/10/13	
Right Tilt 15 Degree	21100/2535	20M QPSK(50,24)	0.067	0.036	0.33	21.84	22.50	0.078	2024/10/13	

NOTE: Head SAR test results of LTE Band 7

Test Position of Body-Worn with 10mm	Test channel /Freq.	Test Mode	SAR Value (W/kg)		Power Drift ( $\pm 5\%$ )	Conducted power (dBm)	Tune-up power (dBm)	Scaled SAR 1g (W/Kg)	Date	Plot
			1-g	10-g						
1RB										
Front Side	21100/2535	20M QPSK(1,49)	0.380	0.220	0.35	22.78	23.50	0.449	2024/10/13	
Back Side	21100/2535	20M QPSK(1,49)	1.216	0.598	-0.33	22.78	23.50	1.435	2024/10/13	26#
Back Side	20850/2510	20M	0.549	0.267	-3.39	23.12	23.50	0.599	2024/10/13	

		QPSK(1,49)								
Back Side	21350/2560	20M QPSK(50,24)	0.369	0.180	3.03	22.59	23.50	0.455	2024/10/13	
BackSide Repeated	21100/2535	20M QPSK(50,24)	1.200	0.590	-2.85	22.78	23.50	1.416	2024/10/13	
50%RB										
Front Side	21100/2535	20M QPSK(50,24)	0.33	0.206	0.21	21.84	22.50	0.384	2024/10/13	
Back Side	21100/2535	20M QPSK(50,24)	1.102	0.517	2.44	21.84	22.50	1.283	2024/10/13	
Back Side	20850/2510	20M QPSK(50,24)	1.152	0.467	-3.39	23.12	22.50	0.999	2024/10/13	
Back Side	21350/2560	20M QPSK(50,24)	1.135	0.487	-3.39	22.59	22.50	1.112	2024/10/13	
Bottom Side Repeated	21100/2535	20M QPSK(50,24)	1.025	0.507	-1.25	21.84	22.50	1.193	2024/10/13	

NOTE: Body-Worn SAR test results of LTE Band 7

Test Position of Hotspot with 10mm	Test channel /Freq.	Test Mode	SAR Value (W/kg)		Power Drift (±5%)	Conducted power (dBm)	Tune-up power (dBm)	Scaled SAR 1g (W/Kg)	Date	Plot
			1-g	10-g						
1RB										
Front Side	21100/2535	20M QPSK(1,49)	0.380	0.220	0.35	22.78	23.50	0.449	2024/10/13	
Back Side	21100/2535	20M QPSK(1,49)	1.216	0.598	-0.33	22.78	23.50	1.435	2024/10/13	26#
Left Side	21100/2535	20M QPSK(1,49)	0.617	0.347	1.12	22.78	23.50	0.728	2024/10/13	
Right Side	21100/2535	20M QPSK(1,49)	0.042	0.030	1.12	22.78	23.50	0.050	2024/10/13	
Bottom Side	21100/2535	20M QPSK(1,49)	0.366	0.175	1.38	22.78	23.50	0.432	2024/10/13	
Back Side	20850/2510	20M QPSK(1,49)	0.549	0.267	-3.39	23.12	23.50	0.599	2024/10/13	
Back Side	21350/2560	20M QPSK(1,49)	0.369	0.180	3.03	22.59	23.50	0.455	2024/10/13	



BackSide Repeated	21100/2535	20M QPSK(1,49))	1.200	0.590	-2.85	22.78	23.50	1.416	2024/10/13	
50%RB										
Front Side	21100/2535	20M QPSK(50,24)	0.33	0.206	0.8	21.84	22.50	0.384	2024/10/13	
Back Side	21100/2535	20M QPSK(50,24)	1.102	0.517	2.44	21.84	22.50	1.283	2024/10/13	
Left Side	21100/2535	20M QPSK(50,24)	0.567	0.317	4.24	21.84	22.50	0.660	2024/10/13	
Right Side	21100/2535	20M QPSK(50,24)	0.039	0.028	-3.51	21.84	22.50	0.045	2024/10/13	
Back Side	20850/2510	20M QPSK(50,24)	1.152	0.467	-3.39	22.21	22.50	1.232	2024/10/13	
Back Side	21350/2560	20M QPSK(50,24)	1.135	0.487	-3.39	21.59	22.50	1.400	2024/10/13	
Bottom Side	21100/2535	20M QPSK(50,24)	0.321	0.162	-4.71	21.84	22.50	0.374	2024/10/13	
Bottom Side Repeated	21100/2535	20M QPSK(50,24)	1.025	0.507	-1.25	21.84	22.50	1.193	2024/10/13	
100%RB										
Back Side	21100/2535	20M QPSK(100,0)	0.324	0.163	-1.11	22.78	23.50	0.382	2024/10/13	

NOTE: Hotspot SAR test results of LTE Band 7

### 9.1.10. SAR measurement Result of LTE Band 12

Test Position of Head	Test channel /Freq.	Test Mode	SAR Value (W/kg)		Power Drift (±5%)	Conducted power (dBm)	Tune-up power (dBm)	Scaled SAR 1g (W/Kg)	Date	Plot
			1-g	10-g						
1RB										
Left Cheek	23095/707.5	10M QPSK(1,24)	0.117	0.109	1.98	24.16	24.50	0.127	2024/10/08	27#
Left Tilt 15 Degree	23095/707.5	10M QPSK(1,24)	0.064	0.057	-3.45	24.16	24.50	0.069	2024/10/08	
Right Cheek	23095/707.5	10M QPSK(1,24)	0.105	0.093	-2.73	24.16	24.50	0.114	2024/10/08	
Right	23095/707.5	10M	0.057	0.051	0.55	24.16	24.50	0.062	2024/10/08	

Tilt 15 Degree		QPSK(1,24)								
50%RB										
Left Cheek	23095/707.5	10M QPSK(25,0)	0.103	0.096	-2.4	23.20	23.50	0.110	2024/10/08	
Left Tilt 15 Degree	23095/707.5	10M QPSK(25,0)	0.056	0.053	-2.35	23.20	23.50	0.060	2024/10/08	
Right Cheek	23095/707.5	10M QPSK(25,0)	0.097	0.079	0.43	23.20	23.50	0.104	2024/10/08	
Right Tilt 15 Degree	23095/707.5	10M QPSK(25,0)	0.052	0.048	-0.18	23.20	23.50	0.056	2024/10/08	

NOTE: Head SAR test results of LTE Band 12

Test Position of Body-Worn with 10mm	Test channel /Freq.	Test Mode	SAR Value (W/kg)		Power Drift (±5%)	Conducted power (dBm)	Tune-up power (dBm)	Scaled SAR 1g (W/Kg)	Date	Plot
			1-g	10-g						
1RB										
Front Side	23095/707.5	10M QPSK(1,24)	0.196	0.166	-0.44	24.16	24.50	0.212	2024/10/08	
Back Side	23095/707.5	10M QPSK(1,24)	0.275	0.237	-0.50	24.16	24.50	0.297	2024/10/08	28#
50%RB										
Front Side	23095/707.5	10M QPSK(25,0)	0.17	0.156	-4.92	23.20	23.50	0.182	2024/10/08	
Back Side	23095/707.5	10M QPSK(25,0)	0.251	0.221	1.22	23.20	23.50	0.269	2024/10/08	

NOTE: Body-Worn SAR test results of LTE Band 12

Test Position of Hotspot with 10mm	Test channel /Freq.	Test Mode	SAR Value (W/kg)		Power Drift (±5%)	Conducted power (dBm)	Tune-up power (dBm)	Scaled SAR 1g (W/Kg)	Date	Plot
			1-g	10-g						
1RB										
Front Side	23095/707.5	10M QPSK(1,24)	0.196	0.166	-0.44	24.16	24.50	0.212	2024/10/08	

Back Side	23095/707.5	10M QPSK(1,24)	0.275	0.237	-0.50	24.16	24.50	0.297	2024/10/08	28#
Left Side	23095/707.5	10M QPSK(1,24)	0.131	0.112	-3.71	24.16	24.50	0.142	2024/10/08	
Right Side	23095/707.5	10M QPSK(1,24)	0.189	0.155	3.75	24.16	24.50	0.204	2024/10/08	
Bottom Side	23095/707.5	10M QPSK(1,24)	0.112	0.097	-0.44	24.16	24.50	0.121	2024/10/08	
50%RB										
Front Side	23095/707.5	10M QPSK(25,0)	0.17	0.156	-4.92	23.20	23.50	0.182	2024/10/08	
Back Side	23095/707.5	10M QPSK(25,0)	0.251	0.221	1.22	23.20	23.50	0.269	2024/10/08	
Left Side	23095/707.5	10M QPSK(25,0)	0.113	0.096	-3.62	23.20	23.50	0.121	2024/10/08	
Right Side	23095/707.5	10M QPSK(25,0)	0.171	0.139	-4.24	23.20	23.50	0.183	2024/10/08	
Bottom Side	23095/707.5	10M QPSK(25,0)	0.097	0.087	2.18	23.20	23.50	0.104	2024/10/08	

NOTE: Hotspot SAR test results of LTE Band 12

### 9.1.11. SAR measurement Result of LTE Band 17

Test Position of Head	Test channel /Freq.	Test Mode	SAR Value (W/kg)		Power Drift (±5%)	Conducted power (dBm)	Tune-up power (dBm)	Scaled SAR 1g (W/Kg)	Date	Plot
			1-g	10-g						
1RB										
Left Cheek	23790/710	10M QPSK(1,0)	0.125	0.115	-1.44	24.10	24.50	0.137	2024/10/08	29#
Left Tilt 15 Degree	23790/710	10M QPSK(1,0)	0.063	0.056	-3.23	24.10	24.50	0.069	2024/10/08	
Right Cheek	23790/710	10M QPSK(1,0)	0.111	0.101	0.5	24.10	24.50	0.122	2024/10/08	
Right Tilt 15 Degree	23790/710	10M QPSK(1,0)	0.053	0.048	1.04	24.10	24.50	0.058	2024/10/08	
50%RB										
Left	23790/710	10M	0.115	0.104	3.76	23.05	23.50	0.128	2024/10/08	

Cheek		QPSK(25,24)								
Left Tilt 15 Degree	23790/710	10M QPSK(25,24)	0.056	0.049	-0.11	23.05	23.50	0.062	2024/10/08	
Right Cheek	23790/710	10M QPSK(25,24)	0.096	0.087	2.51	23.05	23.50	0.106	2024/10/08	
Right Tilt 15 Degree	23790/710	10M QPSK(25,24)	0.045	0.045	-0.78	23.05	23.50	0.050	2024/10/08	

NOTE: Head SAR test results of LTE Band 17

Test Position of Body-Worn with 10mm	Test channel /Freq.	Test Mode	SAR Value (W/kg)		Power Drift (±5%)	Conducted power (dBm)	Tune-up power (dBm)	Scaled SAR 1g (W/Kg)	Date	Plot
			1-g	10-g						
1RB										
Front Side	23790/710	10M QPSK(1,0)	0.224	0.192	-1.7	24.10	24.50	0.246	2024/10/08	
Back Side	23790/710	10M QPSK(1,0)	0.294	0.252	-0.26	24.10	24.50	0.322	2024/10/08	30#
50%RB										
Front Side	23790/710	10M QPSK(25,24)	0.199	0.182	-4.33	23.05	23.50	0.221	2024/10/08	
Back Side	23790/710	10M QPSK(25,24)	0.272	0.23	0.85	23.05	23.50	0.302	2024/10/08	

NOTE: Body-Worn SAR test results of LTE Band 17

Test Position of Hotspot with 10mm	Test channel /Freq.	Test Mode	SAR Value (W/kg)		Power Drift (±5%)	Conducted power (dBm)	Tune-up power (dBm)	Scaled SAR 1g (W/Kg)	Date	Plot
			1-g	10-g						
1RB										
Front Side	23790/710	10M QPSK(1,0)	0.224	0.192	-1.7	24.10	24.50	0.246	2024/10/08	
Back Side	23790/710	10M QPSK(1,0)	0.294	0.252	-0.26	24.10	24.50	0.322	2024/10/08	30#
Left Side	23790/710	10M QPSK(1,0)	0.140	0.120	-3.78	24.10	24.50	0.154	2024/10/08	

Right Side	23790/710	10M QPSK(1,0)	0.208	0.175	-0.16	24.10	24.50	0.228	2024/10/08	
Bottom Side	23790/710	10M QPSK(1,0)	0.132	0.110	3.78	24.10	24.50	0.145	2024/10/08	
50%RB										
Front Side	23790/710	10M QPSK(25,24)	0.199	0.182	-4.33	23.05	23.50	0.221	2024/10/08	
Back Side	23790/710	10M QPSK(25,24)	0.272	0.23	0.85	23.05	23.50	0.302	2024/10/08	
Left Side	23790/710	10M QPSK(25,24)	0.122	0.109	1.42	23.05	23.50	0.135	2024/10/08	
Right Side	23790/710	10M QPSK(25,24)	0.191	0.157	0.78	23.05	23.50	0.212	2024/10/08	
Bottom Side	23790/710	10M QPSK(25,24)	0.115	0.097	-3.72	23.05	23.50	0.128	2024/10/08	

NOTE: Hotspot SAR test results of LTE Band 17

**9.1.12. SAR measurement Result of LTE Band 41**

Test Position of Head	Test channel /Freq.	Test Mode	SAR Value (W/kg)		Power Drift (±5%)	Conducted power (dBm)	Tune-up power (dBm)	Scaled SAR 1g (W/Kg)	Date	Plot
			1-g	10-g						
1RB										
Left Cheek	40620/2593	20M QPSK(1,49)	0.204	0.115	-1.81	23.52	24.00	0.228	2024/10/13	31#
Left Tilt 15 Degree	40620/2593	20M QPSK(1,49)	0.087	0.047	-0.50	23.52	24.00	0.097	2024/10/13	
Right Cheek	40620/2593	20M QPSK(1,49)	0.160	0.085	0.16	23.52	24.00	0.179	2024/10/13	
Right Tilt 15 Degree	40620/2593	20M QPSK(1,49)	0.074	0.041	-2.69	23.52	24.00	0.083	2024/10/13	
50%RB										
Left Cheek	40620/2593	20M QPSK(50,49)	0.100	0.055	2.30	22.43	22.50	0.102	2024/10/13	
Left Tilt 15 Degree	40620/2593	20M QPSK(50,49)	0.045	0.026	-3.44	22.43	22.50	0.046	2024/10/13	

Right Cheek	40620/2593	20M QPSK(50,49)	0.091	0.044	2.88	22.43	22.50	0.092	2024/10/13	
Right Tilt 15 Degree	40620/2593	20M QPSK(50,49)	0.038	0.021	-1.56	22.43	22.50	0.039	2024/10/13	

NOTE: Head SAR test results of LTE Band 41

Test Position of Body-Worn with 10mm	Test channel /Freq.	Test Mode	SAR Value (W/kg)		Power Drift (±5%)	Conducted power (dBm)	Tune-up power (dBm)	Scaled SAR 1g (W/Kg)	Date	Plot
			1-g	10-g						
1RB										
Front Side	40620/2593	20M QPSK(1,49)	0.303	0.143	-1.43	23.52	24.00	0.338	2024/10/13	
Back Side	40620/2593	20M QPSK(1,49)	0.971	0.473	2.43	23.52	24.00	1.084	2024/10/13	32#
Back Side	39750/2506	20M QPSK(1,49)	0.447	0.237	0.00	23.52	24.00	0.499	2024/10/13	
Back Side	41490/2680	20M QPSK(50,49)	0.339	0.176	0.00	23.52	24.00	0.379	2024/10/13	
BackSide Repeated	40620/2593	20M QPSK(50,49)	0.967	0.471	-0.12	23.52	24.00	1.080	2024/10/13	
50%RB										
Front Side	40620/2593	20M QPSK(50,49)	0.277	0.134	-3.78	22.43	22.50	0.282	2024/10/13	
Back Side	40620/2593	20M QPSK(50,49)	0.83	0.445	3.53	22.43	22.50	0.843	2024/10/13	
Back Side	39750/2506	20M QPSK(50,49)	0.725	0.418	0.00	21.91	22.50	0.830	2024/10/13	
Back Side	41490/2680	20M QPSK(50,49)	0.732	0.427	0.00	21.93	22.50	0.835	2024/10/13	
Bottom Side	40620/2593	20M QPSK(50,49)	0.752	0.409	0.74	22.43	22.50	0.764	2024/10/13	

NOTE: Body-Worn SAR test results of LTE Band 41

Test Position of Hotspot with	Test channel /Freq.	Test Mode	SAR Value (W/kg)		Power Drift (±5%)	Conducted power (dBm)	Tune-up power (dBm)	Scaled SAR 1g (W/Kg)	Date	Plot
			1-g	10-g						

10mm										
1RB										
Front Side	40620/2593	20M QPSK(1,49)	0.303	0.143	-1.43	23.52	24.00	0.338	2024/10/13	
Back Side	40620/2593	20M QPSK(1,49)	0.971	0.473	2.43	23.52	24.00	1.084	2024/10/13	32#
Left Side	40620/2593	20M QPSK(1,49)	0.545	0.252	1.04	23.52	24.00	0.609	2024/10/13	
Right Side	40620/2593	20M QPSK(1,49)	0.455	0.219	-3.73	23.52	24.00	0.508	2024/10/13	
Bottom Side	40620/2593	20M QPSK(1,49)	0.300	0.140	-1.23	23.52	24.00	0.335	2024/10/13	
Back Side	39750/2506	20M QPSK(1,49)	0.875	0.398	-2.35	23.11	24.00	1.074	2024/10/13	
Back Side	41490/2680	20M QPSK(1,49)	0.886	0.375	2.74	23.52	24.00	0.990	2024/10/13	
BackSide Repeated	40620/2593	20M QPSK(1,49)	0.967	0.471	-0.12	23.52	24.00	1.080	2024/10/13	
50%RB										
Front Side	40620/2593	20M QPSK(50,49)	0.277	0.134	-3.78	22.43	22.50	0.282	2024/10/13	
Back Side	40620/2593	20M QPSK(50,49)	0.83	0.445	3.53	22.43	22.50	0.843	2024/10/13	
Left Side	40620/2593	20M QPSK(50,49)	0.492	0.226	0.54	22.43	22.50	0.500	2024/10/13	
Right Side	40620/2593	20M QPSK(50,49)	0.391	0.202	-3.3	22.43	22.50	0.397	2024/10/13	
Bottom Side	40620/2593	20M QPSK(50,49)	0.802	0.409	0.74	22.43	22.50	0.815	2024/10/13	
Back Side	39750/2506	20M QPSK(50,49)	0.725	0.418	0.00	21.91	22.50	0.830	2024/10/13	
Back Side	41490/2680	20M QPSK(50,49)	0.732	0.427	0.00	21.93	22.50	0.835	2024/10/13	
BackSide Repeated	40620/2593	20M QPSK(50,49)	0.812	0.425	0.163	22.43	22.50	0.812	2024/10/13	
100%RB										
Back Side	40620/2593	20M QPSK(100,0)	0.311	0.165	-1.95	22.43	22.50	0.311	2024/10/13	

NOTE: Hotspot SAR test results of LTE Band 41

### 9.1.13. SAR measurement Result of LTE Band 66

Test Position of Head	Test channel /Freq.	Test Mode	SAR Value (W/kg)		Power Drift (±5%)	Conducted power (dBm)	Tune-up power (dBm)	Scaled SAR 1g (W/Kg)	Date	Plot
			1-g	10-g						
1RB										
Left Cheek	132322/1745	20M QPSK(1,49)	0.112	0.075	4.25	21.47	22.00	0.127	2024/9/13	33#
Left Tilt 15 Degree	132322/1745	20M QPSK(1,49)	0.059	0.038	2.98	22.00	22.00	0.059	2024/9/13	
Right Cheek	132322/1745	20M QPSK(1,49)	0.101	0.065	-1.67	21.47	22.00	0.114	2024/9/13	
Right Tilt 15 Degree	132322/1745	20M QPSK(1,49)	0.046	0.030	-1.07	21.47	22.00	0.052	2024/9/13	
50%RB										
Left Cheek	132322/1745	20M QPSK(50,0)	0.102	0.07	2.04	20.71	21.00	0.109	2024/9/13	
Left Tilt 15 Degree	132322/1745	20M QPSK(50,0)	0.054	0.035	0.22	20.71	21.00	0.058	2024/9/13	
Right Cheek	132322/1745	20M QPSK(50,0)	0.093	0.06	-0.41	20.71	21.00	0.099	2024/9/13	
Right Tilt 15 Degree	132322/1745	20M QPSK(50,0)	0.04	0.027	-2.52	20.71	21.00	0.043	2024/9/13	

NOTE: Head SAR test results of LTE Band 66

Test Position of Body-Worn with 10mm	Test channel /Freq.	Test Mode	SAR Value (W/kg)		Power Drift (±5%)	Conducted power (dBm)	Tune-up power (dBm)	Scaled SAR 1g (W/Kg)	Date	Plot
			1-g	10-g						
1RB										
Front Side	132322/1745	20M QPSK(1,49)	0.275	0.158	1.04	21.47	22.00	0.311	2024/9/13	
Back Side	132322/1745	20M QPSK(1,49)	0.522	0.310	-0.80	21.47	22.00	0.590	2024/9/13	34#
50%RB										



Front Side	132322/1745	20M QPSK(50,0)	0.259	0.146	1.07	20.71	21.00	0.277	2024/9/13	
Back Side	132322/1745	20M QPSK(50,0)	0.493	0.271	4.78	20.71	21.00	0.527	2024/9/13	

NOTE: Body-Worn SAR test results of LTE Band 66

Test Position of Hotspot with 10mm	Test channel /Freq.	Test Mode	SAR Value (W/kg)		Power Drift (±5%)	Conducted power (dBm)	Tune-up power (dBm)	Scaled SAR 1g (W/Kg)	Date	Plot
			1-g	10-g						
1RB										
Front Side	132322/1745	20M QPSK(1,49)	0.275	0.158	1.04	21.47	22.00	0.311	2024/9/13	
Back Side	132322/1745	20M QPSK(1,49)	0.302	0.174	-2.85	21.47	22.00	0.341	2024/9/13	34#
Left Side	132322/1745	20M QPSK(1,0)	0.522	0.310	-0.80	21.47	22.00	0.590	2024/9/13	
Right Side	132322/1745	20M QPSK(1,49)	0.114	0.068	1.73	21.47	22.00	0.129	2024/9/13	
Bottom Side	132322/1745	20M QPSK(1,49)	0.392	0.230	2.05	21.47	22.00	0.443	2024/9/13	
50%RB										
Front Side	132322/1745	20M QPSK(50,0)	0.259	0.146	1.07	20.71	21.00	0.277	2024/9/13	
Back Side	132322/1745	20M QPSK(50,0)	0.493	0.271	4.78	20.71	21.00	0.527	2024/9/13	
Left Side	132322/1745	20M QPSK(50,0)	0.282	0.149	1.58	20.71	21.00	0.301	2024/9/13	
Right Side	132322/1745	20M QPSK(50,0)	0.099	0.06	-0.45	20.71	21.00	0.106	2024/9/13	
Bottom Side	132322/1745	20M QPSK(50,0)	0.356	0.213	2.8	20.71	21.00	0.381	2024/9/13	

NOTE: Hotspot SAR test results of LTE Band 66

**9.1.14. SAR measurement Result of WLAN2.4G**

Test Position	Test channel /Freq.	Test Mode	SAR Value (W/kg)	Power Drift	Conducted power	Tune-up power	Scaled SAR	Date	Plot
---------------	---------------------	-----------	------------------	-------------	-----------------	---------------	------------	------	------

of Head			1-g	10-g	(±5%)	(dBm)	(dBm)	1g (W/Kg)		
Left Cheek	11/2462	802.11b	0.401	0.202	-1.02	12.25	12.50	0.425	2024/9/16	17#
Left Tilt 15 Degree	11/2462	802.11b	0.206	0.103	3.4	12.25	12.50	0.218	2024/9/16	
Right Cheek	11/2462	802.11b	0.361	0.176	3.7	12.25	12.50	0.382	2024/9/16	
Right Tilt 15 Degree	11/2462	802.11b	0.166	0.079	3.54	12.25	12.50	0.176	2024/9/16	

NOTE: Head SAR test results of WLAN2.4G

Test Position of Body-Worn with 10mm	Test channel /Freq.	Test Mode	SAR Value (W/kg)		Power Drift (±5%)	Conducted power (dBm)	Tune-up power (dBm)	Scaled SAR 1g (W/Kg)	Date	Plot
			1-g	10-g						
Front Side	11/2462	802.11b	0.114	0.064	-3.68	12.25	12.50	0.121	2024/9/16	
Back Side	11/2462	802.11b	0.141	0.080	-0.18	12.25	12.50	0.149	2024/9/16	16#

NOTE: Body-worn SAR test results of WLAN2.4G

Test Position of Hotspot with 10mm	Test channel /Freq.	Test Mode	SAR Value (W/kg)		Power Drift (±5%)	Conducted power (dBm)	Tune-up power (dBm)	Scaled SAR 1g (W/Kg)	Date	Plot
			1-g	10-g						
Front Side	11/2462	802.11b	0.114	0.064	-3.68	12.25	12.50	0.121	2024/9/16	
Back Side	11/2462	802.11b	0.141	0.080	-0.18	12.25	12.50	0.149	2024/9/16	18#
Right Side	11/2462	802.11b	0.054	0.029	-2.75	12.25	12.50	0.057	2024/9/16	
Top Side	11/2462	802.11b	0.045	0.026	-0.83	12.25	12.50	0.048	2024/9/16	

NOTE: Hotspot SAR test results of WLAN2.4G

**9.1.15. SAR measurement Result of WLAN5.2G**

Test Position	Test channel /Freq.	Mode	SAR Value (W/kg)	Power Drift(%)	Conducted Power	Tune-up Power	Scaled SAR	Date	Plot
------------------	------------------------	------	---------------------	-------------------	--------------------	------------------	---------------	------	------

of Head			1-g	10-g		(dBm)	(dBm)	1-g (W/Kg)		
Left Cheek	48/5240	802.11a	0.307	0.122	-2.22	5.41	5.50	0.313	2024/10/05	13#
Left Tilt 15 Degree	48/5240	802.11a	0.176	0.068	0.43	5.41	5.50	0.180	2024/10/05	
Right Cheek	48/5240	802.11a	0.276	0.106	-1.19	5.41	5.50	0.282	2024/10/05	
Right Tilt 15 Degree	48/5240	802.11a	0.142	0.056	-3.99	5.41	5.50	0.145	2024/10/05	

NOTE: Head SAR test results of WLAN5.2G

Test Position of Body-Worn with 10mm	Test channel /Freq.	Mode	SAR Value (W/kg)		Power Drift(%)	Conducted Power (dBm)	Tune-up Power (dBm)	Scaled SAR 1-g (W/Kg)	Date	Plot
			1-g	10-g						
Front Side	48/5240	802.11a	0.048	0.023	-3.03	5.41	5.50	0.049	2024/10/05	
Back Side	48/5240	802.11a	0.065	0.033	0.00	5.41	5.50	0.066	2024/10/05	15#

NOTE: Body-worn SAR test results of WLAN5.2G

Test Position of Hotspot with 10mm	Test channel /Freq.	Mode	SAR Value (W/kg)		Power Drift(%)	Conducted Power (dBm)	Tune-up Power (dBm)	Scaled SAR 1-g (W/Kg)	Date	Plot
			1-g	10-g						
Front Side	48/5240	802.11a	0.048	0.023	-3.03	5.41	5.50	0.049	2024/10/05	
Back Side	48/5240	802.11a	0.065	0.033	0.00	5.41	5.50	0.066	2024/10/05	17#
Right Side	48/5240	802.11a	0.030	0.015	-3.93	5.41	5.50	0.031	2024/10/05	
Top Side	48/5240	802.11a	0.021	0.011	-3.37	5.41	5.50	0.021	2024/10/05	

NOTE: Hotspot SAR test results of WLAN5.2G

**9.1.16. SAR measurement Result of WLAN5.8G**

Test	Test channel	Mode	SAR Value	Power	Conducted	Tune-up	Scaled	Date	Plot
------	--------------	------	-----------	-------	-----------	---------	--------	------	------

Position of Head	/Freq.		(W/kg)		Drift(%)	Power (dBm)	Power (dBm)	SAR 1-g (W/Kg)		
			1-g	10-g						
Left Cheek	155/5775	802.11ac VHT80	0.470	0.167	-2.85	7.09	7.50	0.517	2024/10/07	16#
Left Tilt 15 Degree	155/5775	802.11ac VHT80	0.249	0.086	-0.36	7.09	7.50	0.274	2024/10/07	
Right Cheek	155/5775	802.11ac VHT80	0.433	0.149	-2.78	7.09	7.50	0.476	2024/10/07	
Right Tilt 15 Degree	155/5775	802.11ac VHT80	0.21	0.072	-3.33	7.09	7.50	0.231	2024/10/07	

NOTE: Head SAR test results of WLAN5.8G

Test Position of Body-Worn with 10mm	Test channel /Freq.	Mode	SAR Value (W/kg)		Power Drift(%)	Conducted Power (dBm)	Tune-up Power (dBm)	Scaled SAR 1-g (W/Kg)	Date	Plot
			1-g	10-g						
Front Side	155/5775	802.11ac VHT80	0.108	0.059	-1.77	7.09	7.50	0.119	2024/10/07	
Back Side	155/5775	802.11ac VHT80	0.141	0.077	3.85	7.09	7.50	0.155	2024/10/07	16#

NOTE: Body-worn SAR test results of WLAN5.8G

Test Position of Hotspot with 10mm	Test channel /Freq.	Mode	SAR Value (W/kg)		Power Drift(%)	Conducted Power (dBm)	Tune-up Power (dBm)	Scaled SAR 1-g (W/Kg)	Date	Plot
			1-g	10-g						
Front Side	155/5775	802.11ac VHT80	0.108	0.059	-1.77	7.09	7.50	0.119	2024/10/07	
Back Side	155/5775	802.11ac VHT80	0.141	0.077	3.85	7.09	7.50	0.155	2024/10/07	18#
Right Side	155/5775	802.11ac VHT80	0.045	0.024	-2.37	7.09	7.50	0.049	2024/10/07	
Top Side	155/5775	802.11ac VHT80	0.057	0.031	-3.62	7.09	7.50	0.063	2024/10/07	

NOTE: Hotspot SAR test results of WLAN5.8G

Test Position of Head	Test channel /Freq.	Mode	SAR Value (W/kg)		Power Drift(%)	Conducted Power (dBm)	Tune-up Power (dBm)	Scaled SAR 1-g (W/Kg)	Date	Plot
			1-g	10-g						
Left Cheek	78/2480	1DH5	0.045	0.028	2.79	7.12	8.00	0.055	2024/9/16	11#
Left Tilt 15 Degree	78/2480	1DH5	0.026	0.016	-2.9	7.12	8.00	0.032	2024/9/16	
Right Cheek	78/2480	1DH5	0.04	0.024	-3.81	7.12	8.00	0.049	2024/9/16	
Right Tilt 15 Degree	78/2480	1DH5	0.019	0.017	3.85	7.12	8.00	0.023	2024/9/16	

NOTE: Head SAR test results of BT

Test Position of Body-Worn with 10mm	Test channel /Freq.	Mode	SAR Value (W/kg)		Power Drift(%)	Conducted Power (dBm)	Tune-up Power (dBm)	Scaled SAR 1-g (W/Kg)	Date	Plot
			1-g	10-g						
Front Side	78/2480	1DH5	0.018	0.016	-0.73	7.12	8.00	0.022	2024/9/16	
Back Side	78/2480	1DH5	0.025	0.017	0.70	7.12	8.00	0.031	2024/9/16	12#

NOTE: Body-worn SAR test results of BT

Test Position of Hotspot with 10mm	Test channel /Freq.	Mode	SAR Value (W/kg)		Power Drift(%)	Conducted Power (dBm)	Tune-up Power (dBm)	Scaled SAR 1-g (W/Kg)	Date	Plot
			1-g	10-g						
Front Side	78/2480	1DH5	0.018	0.016	-0.73	7.12	8.00	0.022	2024/9/16	
Back Side	78/2480	1DH5	0.025	0.017	0.70	7.12	8.00	0.031	2024/9/16	12#
Right Side	78/2480	1DH5	0.018	0.016	-2.81	7.12	8.00	0.022	2024/9/16	
Top Side	78/2480	1DH5	0.012	0.010	-0.42	7.12	8.00	0.015	2024/9/16	

NOTE: Hotspot SAR test results of BT

### 9.2. Simultaneous Transmission Analysis

Per KDB 447498 D01, simultaneous transmission SAR is compliant if,

- 1) Scalar SAR summation < 1.6W/kg.
- 2)  $SPLSR = (SAR_1 + SAR_2)^{1.5} / (\text{min. separation distance, mm})$ , and the peak separation distance is determined from the square root of  $[(x_1-x_2)^2 + (y_1-y_2)^2 + (z_1-z_2)^2]$ , where  $(x_1, y_1, z_1)$  and  $(x_2, y_2, z_2)$  are the coordinates of the extrapolated peak SAR locations in the zoom scan. If  $SPLSR \leq 0.04$ , simultaneously transmission SAR measurement is not necessary.

Test Position		Scaled SAR <sub>MAX</sub>		Σ 1-g SAR (W/Kg)	SPLSR	Remark
		WWAN	DTS			
Head	Left Cheek	0.228	0.425	0.653	N/A	N/A
	Left Tilt 15 Degree	0.113	0.218	0.331	N/A	N/A
	Right Cheek	0.179	0.382	0.561	N/A	N/A
	Right Tilt 15 Degree	0.086	0.176	0.262	N/A	N/A
Body-Worn	Front Side	0.449	0.121	0.57	N/A	N/A
	Back Side	1.435	0.149	1.584	N/A	N/A
Hotspot	Front Side	0.449	0.121	0.57	N/A	N/A
	Back Side	1.435	0.149	1.584	N/A	N/A
	Left Side	0.728	N/A	0.653	N/A	N/A
	Right Side	0.397	0.057	0.454	N/A	N/A
	Top Side	N/A	0.048	0.561	N/A	N/A
	Bottom Side	0.789	N/A	0.262	N/A	N/A

Test Position		Scaled SAR <sub>MAX</sub>		$\Sigma$ 1-g SAR (W/Kg)	SPLSR	Remark
		WWAN	NII			
Head	Left Cheek	0.228	0.517	0.745	N/A	N/A
	Left Tilt 15 Degree	0.113	0.274	0.387	N/A	N/A
	Right Cheek	0.179	0.476	0.655	N/A	N/A
	Right Tilt 15 Degree	0.086	0.231	0.317	N/A	N/A
Body-Worn	Front Side	0.449	0.119	0.568	N/A	N/A
	Back Side	1.435	0.123	1.558	N/A	N/A
Hotspot	Front Side	0.449	0.119	0.568	N/A	N/A
	Back Side	1.435	0.123	1.558	N/A	N/A
	Left Side	0.728	N/A	0.728	N/A	N/A
	Right Side	0.397	0.063	0.46	N/A	N/A
	Top Side	N/A	0.119	0.119	N/A	N/A
	Bottom Side	0.789	N/A	0.789	N/A	N/A

Test Position		Scaled SAR <sub>MAX</sub>		$\Sigma$ 1-g SAR (W/Kg)	SPLSR	Remark
		WWAN	DSS			
Head	Left Cheek	0.228	0.055	0.283	N/A	N/A
	Left Tilt 15 Degree	0.113	0.032	0.145	N/A	N/A
	Right Cheek	0.179	0.049	0.228	N/A	N/A
	Right Tilt 15 Degree	0.086	0.023	0.109	N/A	N/A
Body-Worn	Front Side	0.449	0.022	0.471	N/A	N/A
	Back Side	1.435	0.031	1.466	N/A	N/A
Hotspot	Front Side	0.449	0.022	0.471	N/A	N/A
	Back Side	1.435	0.031	1.466	N/A	N/A
	Left Side	0.728	N/A	0.728	N/A	N/A
	Right Side	0.397	0.022	0.419	N/A	N/A
	Top Side	N/A	0.015	0.015	N/A	N/A
	Bottom Side	0.789	N/A	0.789	N/A	N/A

## 10. Appendix A. Photo documentation

Refer to appendix Test Setup photo---SAR



## 11. Appendix B. System Check Plots

Table of contents
<b>MEASUREMENT 1 System Performance Check - 750MHz</b>
<b>MEASUREMENT 2 System Performance Check - 835MHz</b>
<b>MEASUREMENT 3 System Performance Check - 1800MHz</b>
<b>MEASUREMENT 4 System Performance Check - 1900MHz</b>
<b>MEASUREMENT 5 System Performance Check - 2450MHz</b>
<b>MEASUREMENT 6 System Performance Check - 2600MHz</b>
<b>MEASUREMENT 7 System Performance Check - 5200MHz</b>
<b>MEASUREMENT 8 System Performance Check - 5800MHz</b>

# MEASUREMENT 1

Date of measurement: 21/9/2024

## A. Experimental conditions.

<b>Area Scan</b>	<u>dx=15mm dy=15mm, h= 5.00 mm</u>
<b>ZoomScan</b>	<u>5x5x7, dx=8mm dy=8mm dz=5mm</u>
<b>Phantom</b>	<u>Validation plane</u>
<b>Device Position</b>	<u>Dipole</u>
<b>Band</b>	<u>CW750</u>
<b>Channels</b>	<u>Middle</u>
<b>Signal</b>	<u>CW (Crest factor: 1.0)</u>
<b>ConvF</b>	<u>2.42</u>

## B. SAR Measurement Results

<b>Frequency (MHz)</b>	750.000000
<b>Relative permittivity (real part)</b>	40.424361
<b>Relative permittivity (imaginary part)</b>	21.432888
<b>Conductivity (S/m)</b>	0.893037
<b>Variation (%)</b>	-0.180000

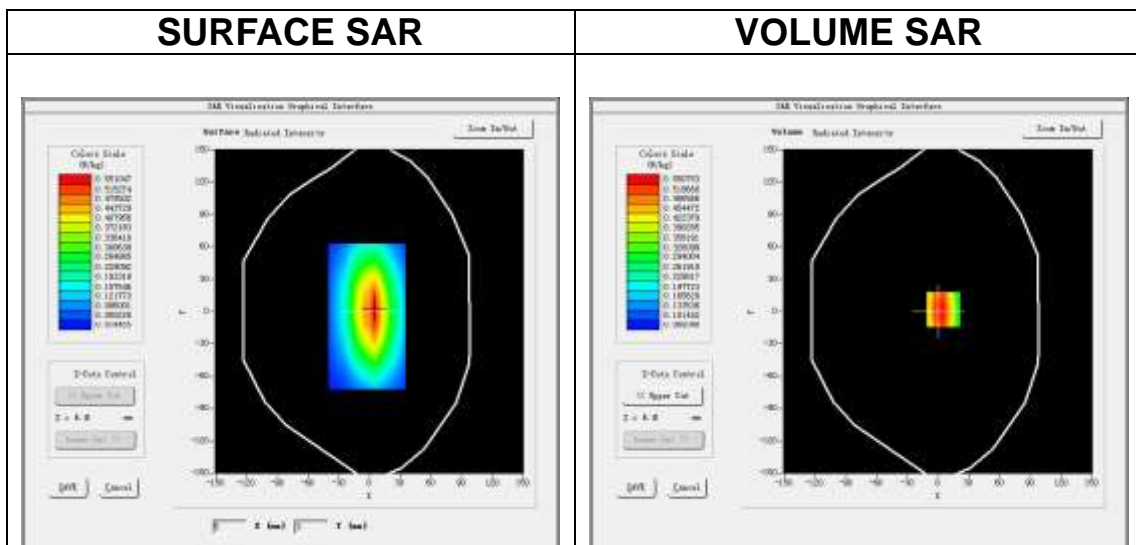

**Maximum location: X=5.00, Y=2.00**

**SAR Peak: 0.74 W/kg**

<b>SAR 10g (W/Kg)</b>	0.363533
<b>SAR 1g (W/Kg)</b>	0.539981

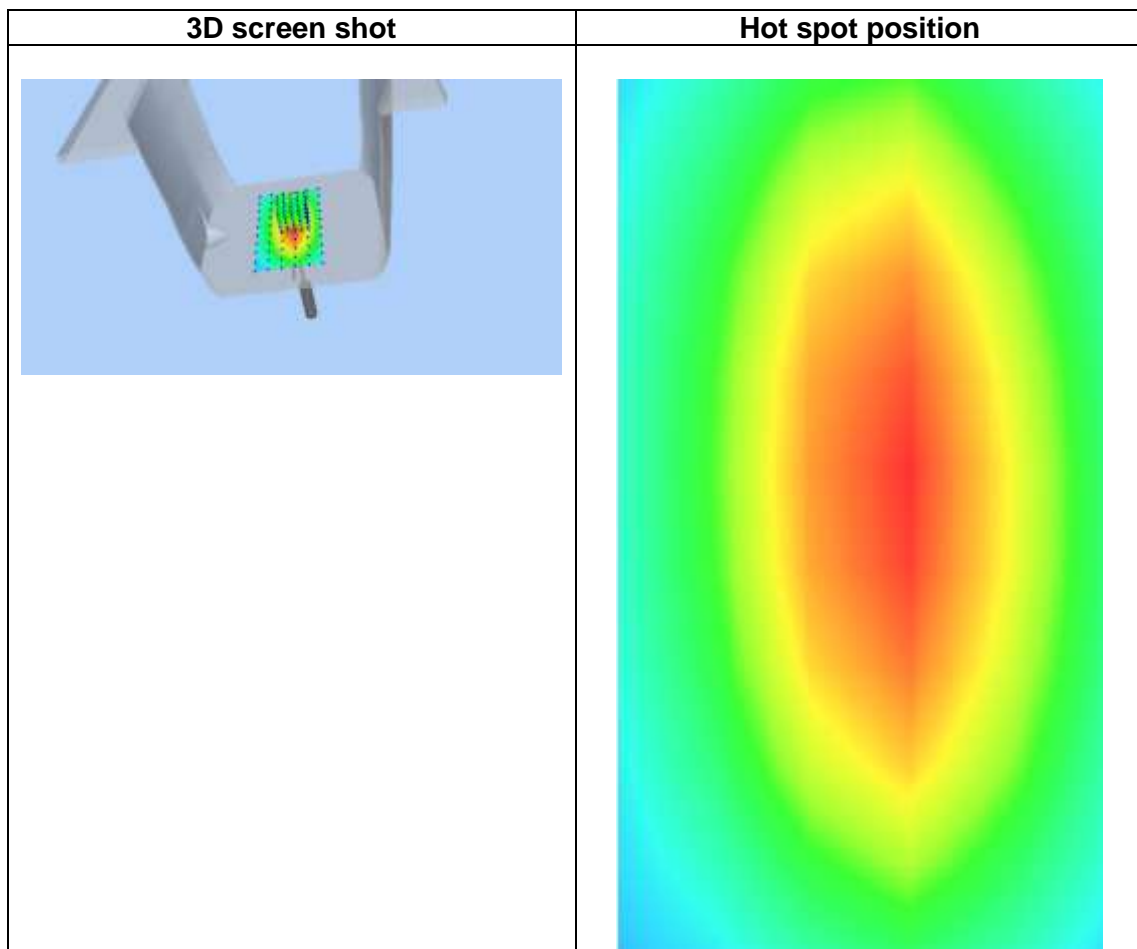
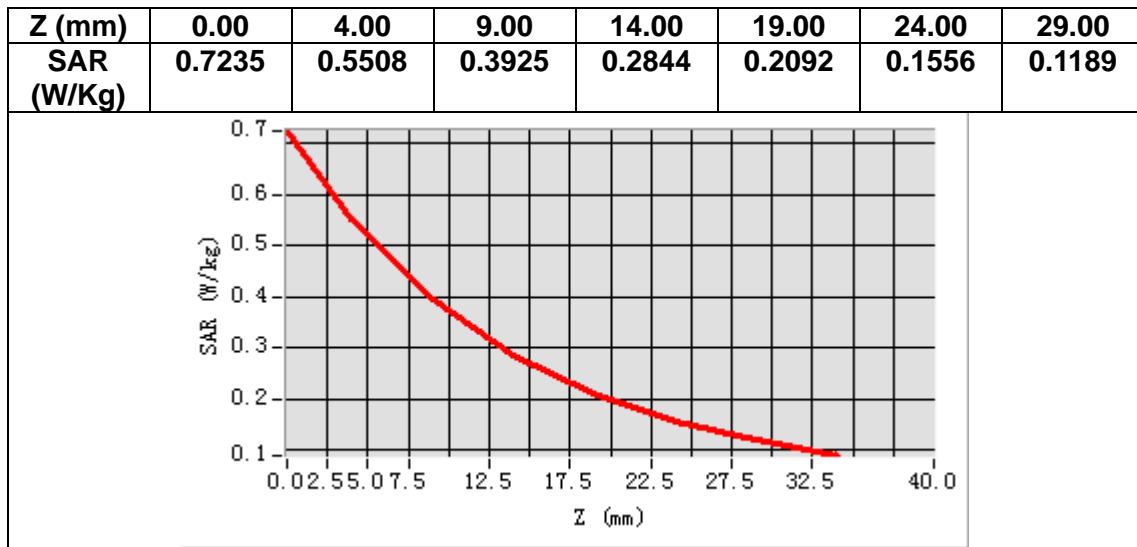

## MEASUREMENT 2

Date of measurement: 25/9/2024

### A. Experimental conditions.

<b>Area Scan</b>	<u>dx=15mm dy=15mm, h= 5.00 mm</u>
<b>ZoomScan</b>	<u>5x5x7,dx=8mm dy=8mm dz=5mm</u>
<b>Phantom</b>	<u>Validation plane</u>
<b>Device Position</b>	<u>Dipole</u>
<b>Band</b>	<u>CW835</u>
<b>Channels</b>	<u>Middle</u>
<b>Signal</b>	<u>CW (Crest factor: 1.0)</u>
<b>ConvF</b>	<u>2.34</u>

### B. SAR Measurement Results

<b>Frequency (MHz)</b>	835.000000
<b>Relative permittivity (real part)</b>	42.090089
<b>Relative permittivity (imaginary part)</b>	19.822689
<b>Conductivity (S/m)</b>	0.919553
<b>Variation (%)</b>	-0.290000

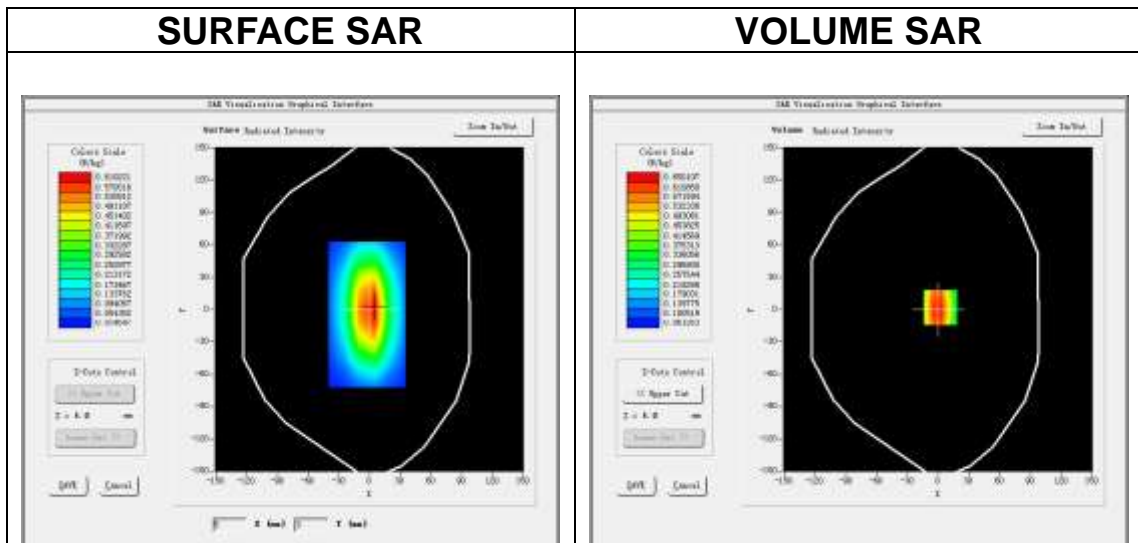

**Maximum location: X=2.00, Y=2.00**

**SAR Peak: 0.92 W/kg**

<b>SAR 10g (W/Kg)</b>	0.407878
-----------------------	----------

<b>SAR 1g (W/Kg)</b>	<b>0.638460</b>
----------------------	-----------------

Z (mm)	0.00	4.00	9.00	14.00	19.00	24.00	29.00
<b>SAR (W/Kg)</b>	<b>0.8973</b>	<b>0.6501</b>	<b>0.4389</b>	<b>0.3030</b>	<b>0.2147</b>	<b>0.1541</b>	<b>0.1106</b>

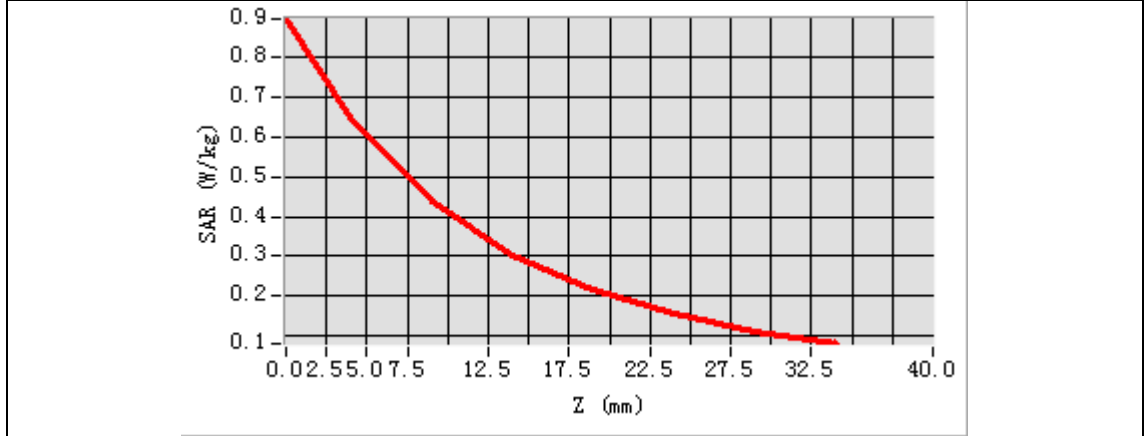

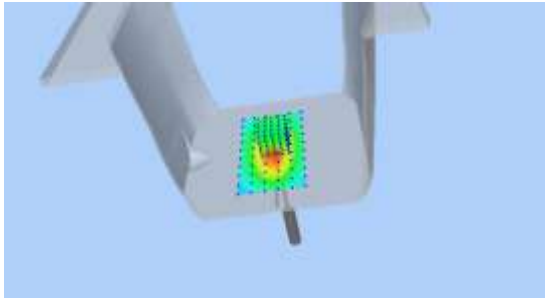
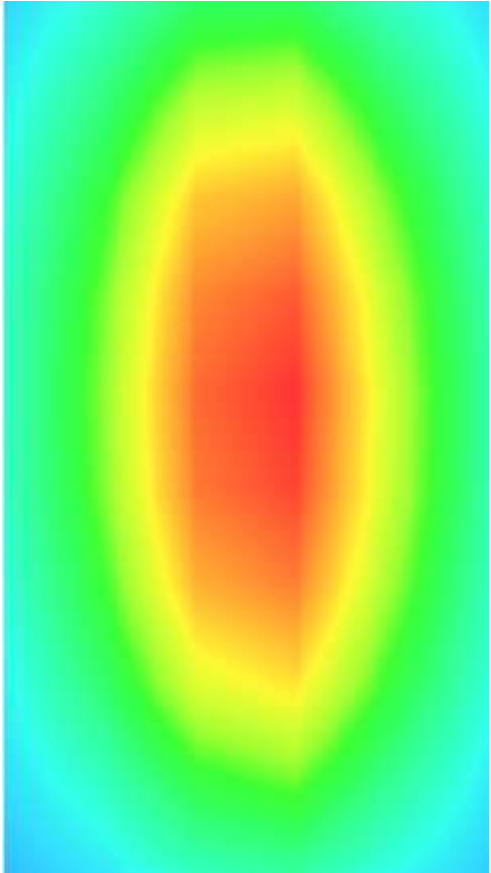
3D screen shot	Hot spot position
	

## MEASUREMENT 3

Date of measurement: 13/9/2024

### A. Experimental conditions.

<b>Area Scan</b>	<u>dx=15mm dy=15mm, h= 5.00 mm</u>
<b>ZoomScan</b>	<u>5x5x7, dx=8mm dy=8mm dz=5mm</u>
<b>Phantom</b>	<u>Validation plane</u>
<b>Device Position</b>	<u>Dipole</u>
<b>Band</b>	<u>CW1800</u>
<b>Channels</b>	<u>Middle</u>
<b>Signal</b>	<u>CW (Crest factor: 1.0)</u>
<b>ConvF</b>	<u>2.45</u>

### B. SAR Measurement Results

<b>Frequency (MHz)</b>	1800.000000
<b>Relative permittivity (real part)</b>	39.320408
<b>Relative permittivity (imaginary part)</b>	13.742189
<b>Conductivity (S/m)</b>	1.374219
<b>Variation (%)</b>	-0.430000

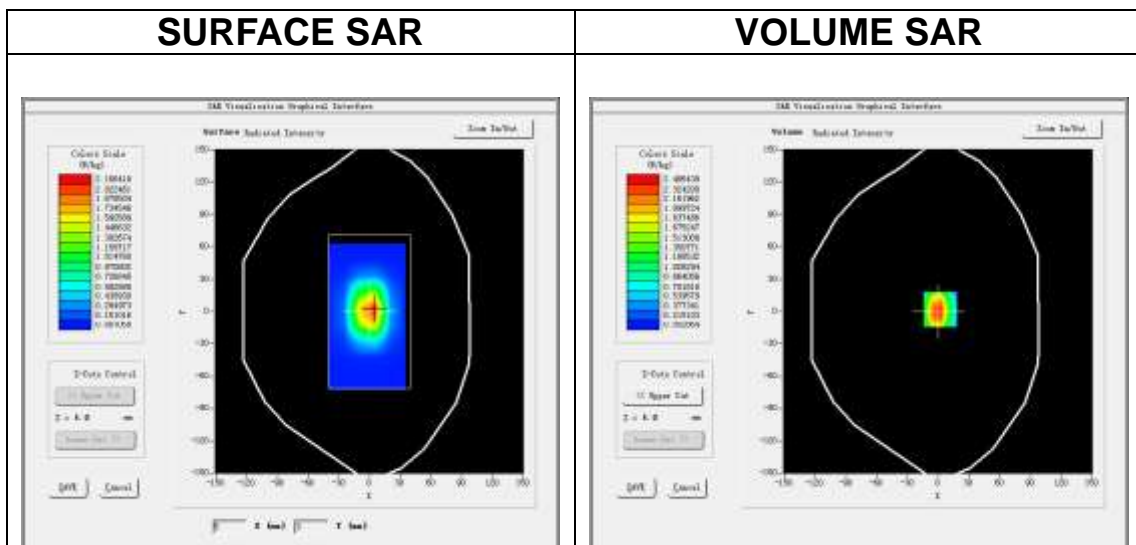

**Maximum location: X=2.00, Y=2.00**

**SAR Peak: 4.00 W/kg**

<b>SAR 10g (W/Kg)</b>	1.246602
<b>SAR 1g (W/Kg)</b>	2.407766

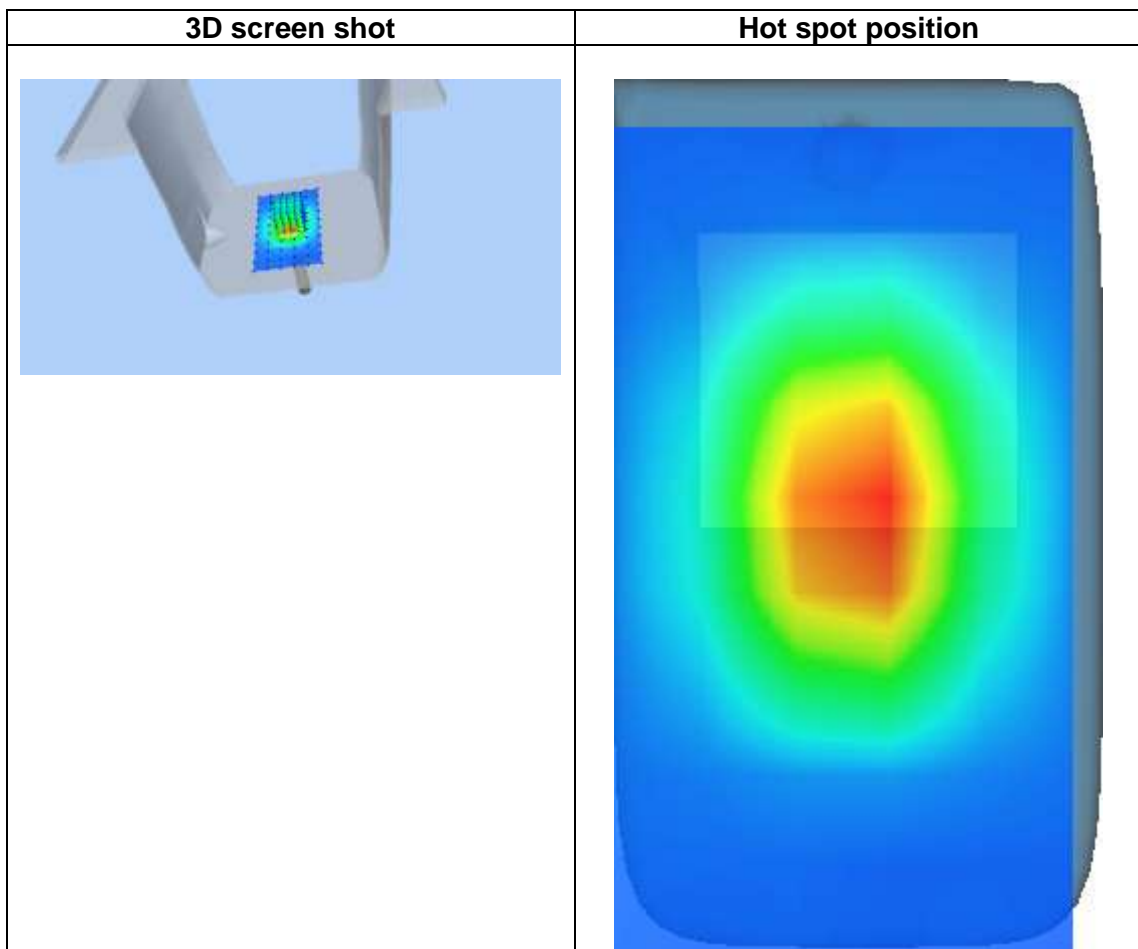
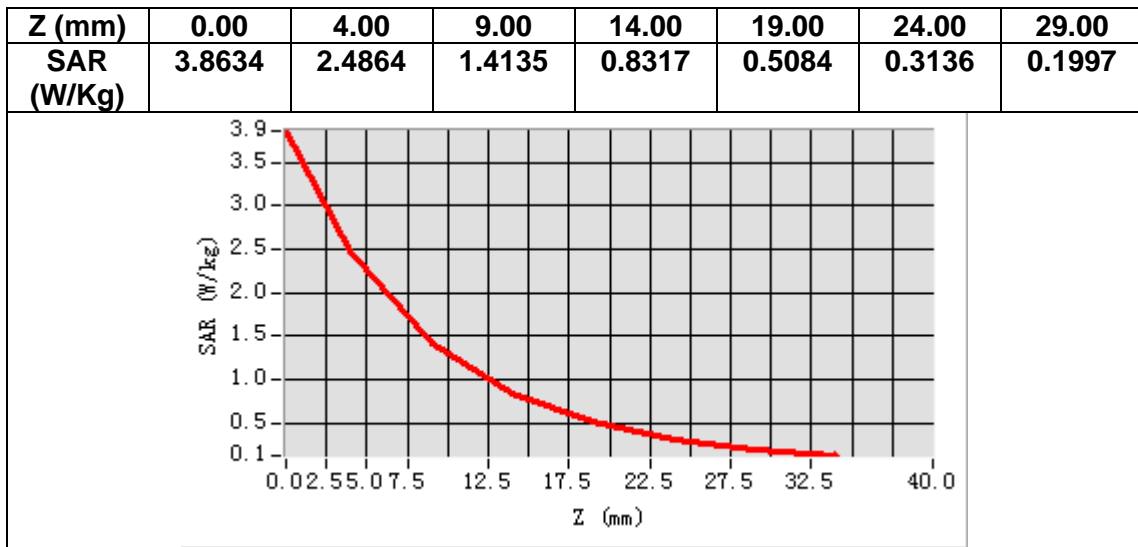

# MEASUREMENT 4

Date of measurement: 26/9/2024

## A. Experimental conditions.

<b>Area Scan</b>	<u>dx=15mm dy=15mm, h= 5.00 mm</u>
<b>ZoomScan</b>	<u>5x5x7,dx=8mm dy=8mm dz=5mm</u>
<b>Phantom</b>	<u>Validation plane</u>
<b>Device Position</b>	<u>Dipole</u>
<b>Band</b>	<u>CW1900</u>
<b>Channels</b>	<u>Middle</u>
<b>Signal</b>	<u>CW (Crest factor: 1.0)</u>
<b>ConvF</b>	<u>2.57</u>

## B. SAR Measurement Results

<b>Frequency (MHz)</b>	1900.000000
<b>Relative permittivity (real part)</b>	38.440114
<b>Relative permittivity (imaginary part)</b>	13.715587
<b>Conductivity (S/m)</b>	1.447756
<b>Variation (%)</b>	-0.070000

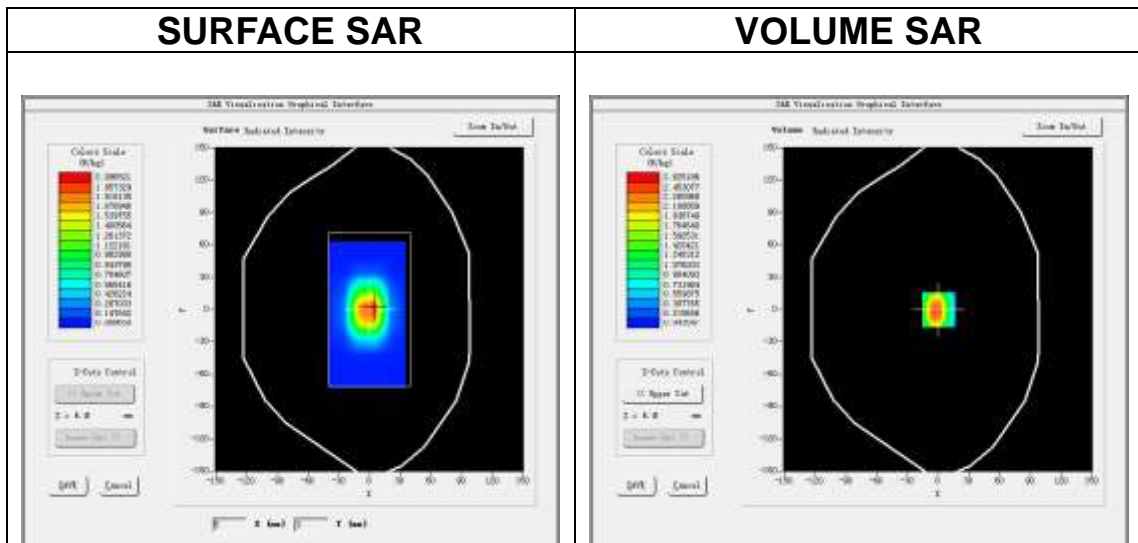

**Maximum location: X=1.00, Y=0.00**

**SAR Peak: 4.36 W/kg**

<b>SAR 10g (W/Kg)</b>	1.287791
-----------------------	----------



<b>SAR 1g (W/Kg)</b>	<b>2.631295</b>
----------------------	-----------------

<b>Z (mm)</b>	<b>0.00</b>	<b>4.00</b>	<b>9.00</b>	<b>14.00</b>	<b>19.00</b>	<b>24.00</b>	<b>29.00</b>
<b>SAR (W/Kg)</b>	<b>4.2098</b>	<b>2.6252</b>	<b>1.4180</b>	<b>0.8066</b>	<b>0.4631</b>	<b>0.2738</b>	<b>0.1645</b>

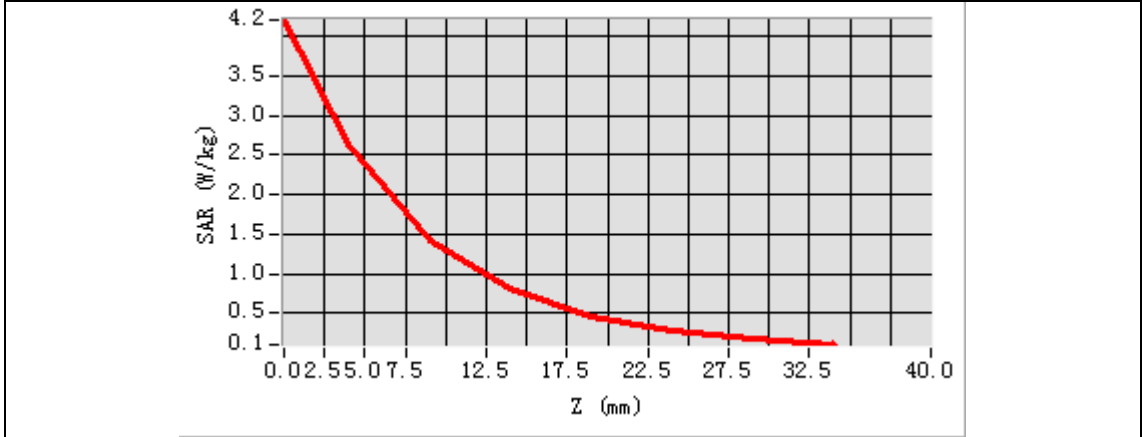

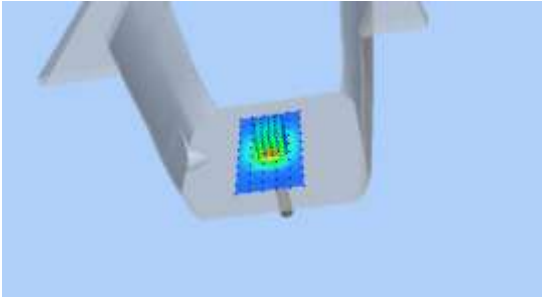
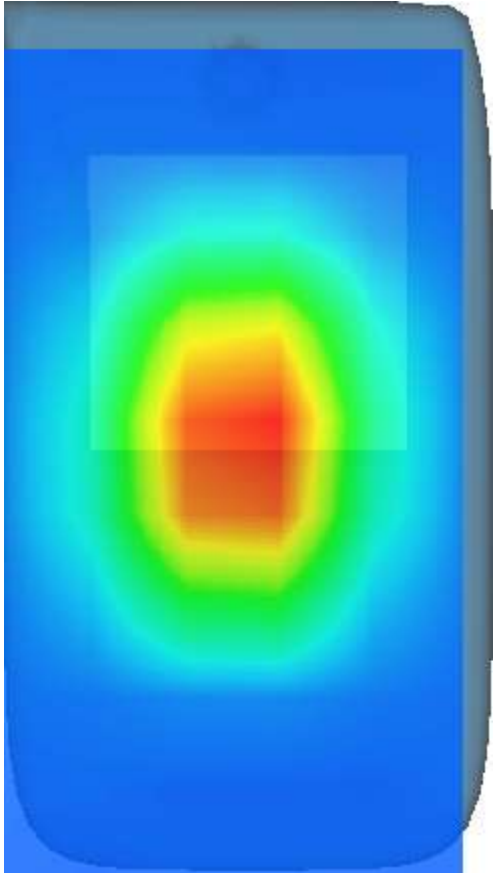
<b>3D screen shot</b>	<b>Hot spot position</b>
	

# MEASUREMENT 5

Date of measurement: 16/9/2024

## A. Experimental conditions.

<b>Area Scan</b>	<u>dx=12mm dy=12mm, h= 5.00 mm</u>
<b>ZoomScan</b>	<u>7x7x7,dx=5mm dy=5mm dz=5mm</u>
<b>Phantom</b>	<u>Validation plane</u>
<b>Device Position</b>	<u>Dipole</u>
<b>Band</b>	<u>CW2450</u>
<b>Channels</b>	<u>Middle</u>
<b>Signal</b>	<u>CW (Crest factor: 1.0)</u>
<b>ConvF</b>	<u>2.85</u>

## B. SAR Measurement Results

<b>Frequency (MHz)</b>	2450.000000
<b>Relative permittivity (real part)</b>	40.110912
<b>Relative permittivity (imaginary part)</b>	13.431449
<b>Conductivity (S/m)</b>	1.828169
<b>Variation (%)</b>	-3.670000

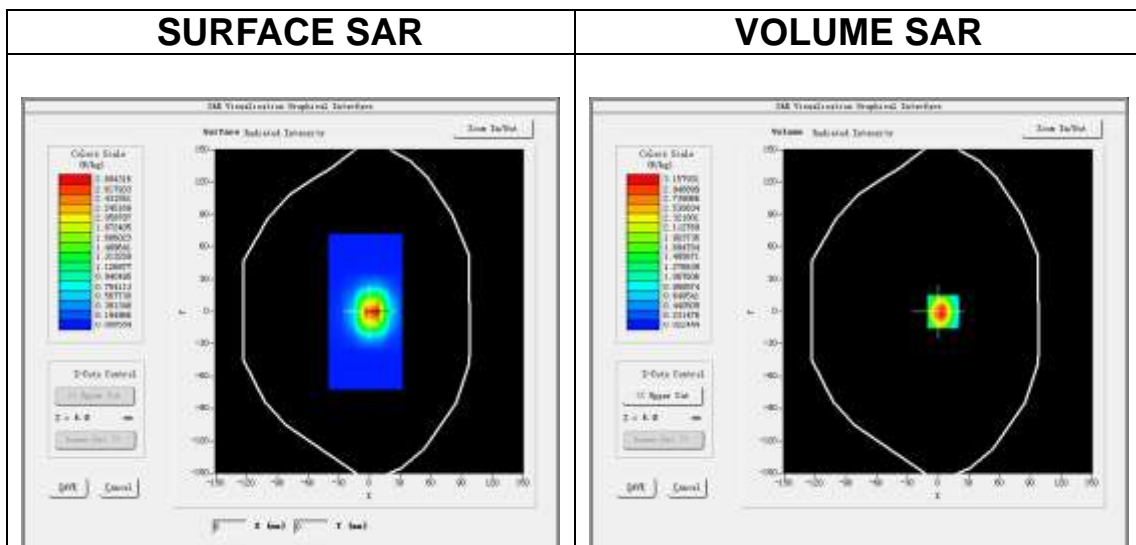

**Maximum location: X=5.00, Y=0.00**

**SAR Peak: 5.23 W/kg**

<b>SAR 10g (W/Kg)</b>	1.423636
<b>SAR 1g (W/Kg)</b>	2.975236

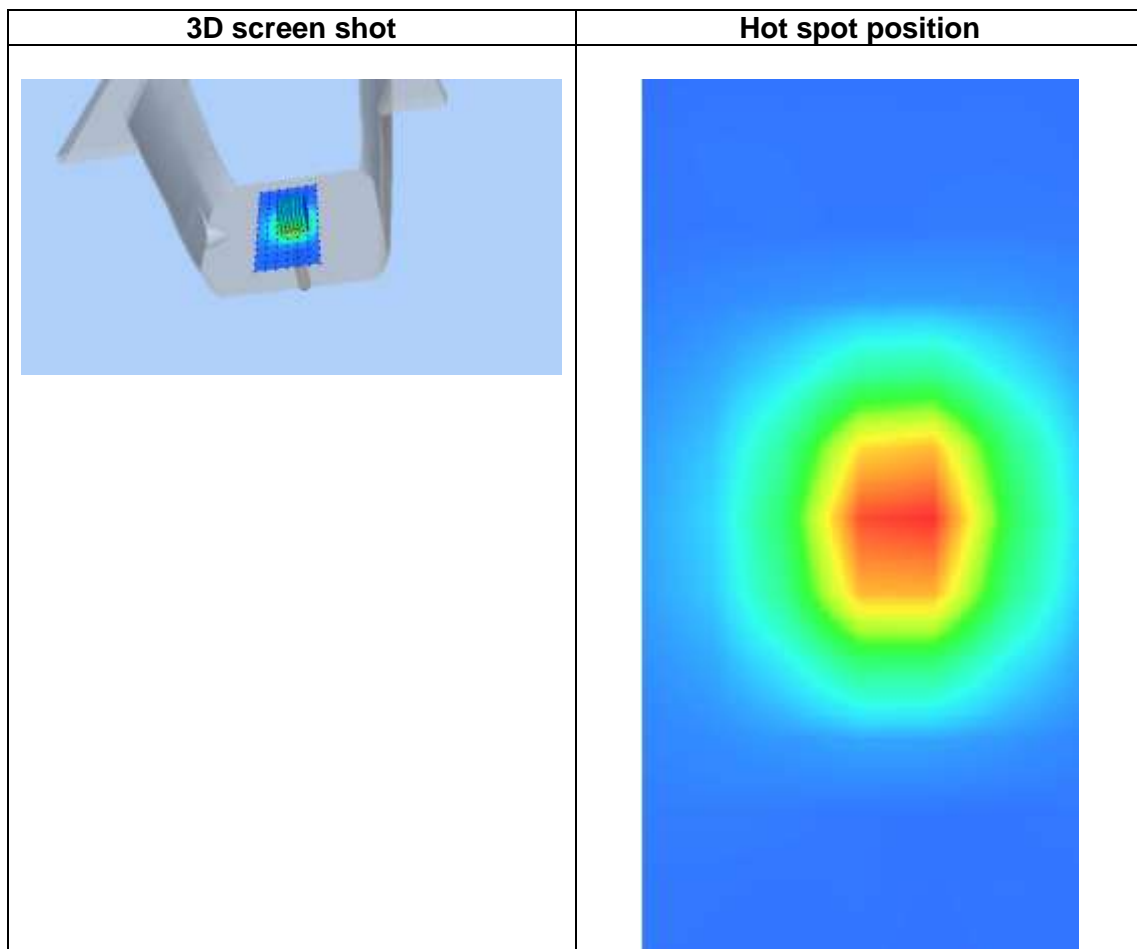
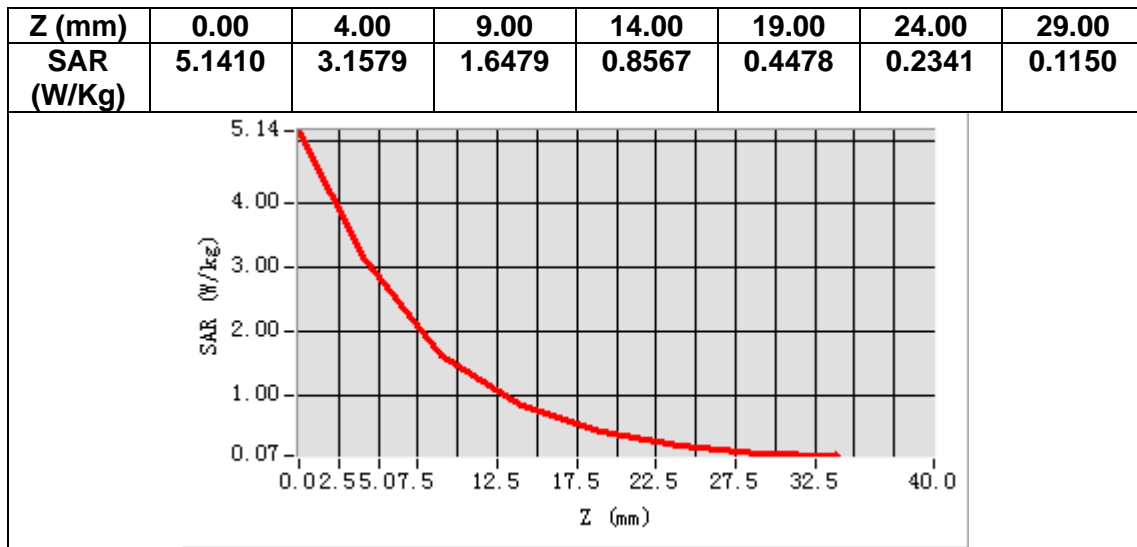

# MEASUREMENT 6

Date of measurement: 13/10/2024

## A. Experimental conditions.

<b>Area Scan</b>	<u>dx=12mm dy=12mm, h= 5.00 mm</u>
<b>ZoomScan</b>	<u>7x7x7,dx=5mm dy=5mm dz=5mm</u>
<b>Phantom</b>	<u>Validation plane</u>
<b>Device Position</b>	<u>Dipole</u>
<b>Band</b>	<u>CW2600</u>
<b>Channels</b>	<u>Middle</u>
<b>Signal</b>	<u>CW (Crest factor: 1.0)</u>
<b>ConvF</b>	<u>2.51</u>

## B. SAR Measurement Results

<b>Frequency (MHz)</b>	2600.000000
<b>Relative permittivity (real part)</b>	38.950442
<b>Relative permittivity (imaginary part)</b>	14.049088
<b>Conductivity (S/m)</b>	2.029313
<b>Variation (%)</b>	0.520000

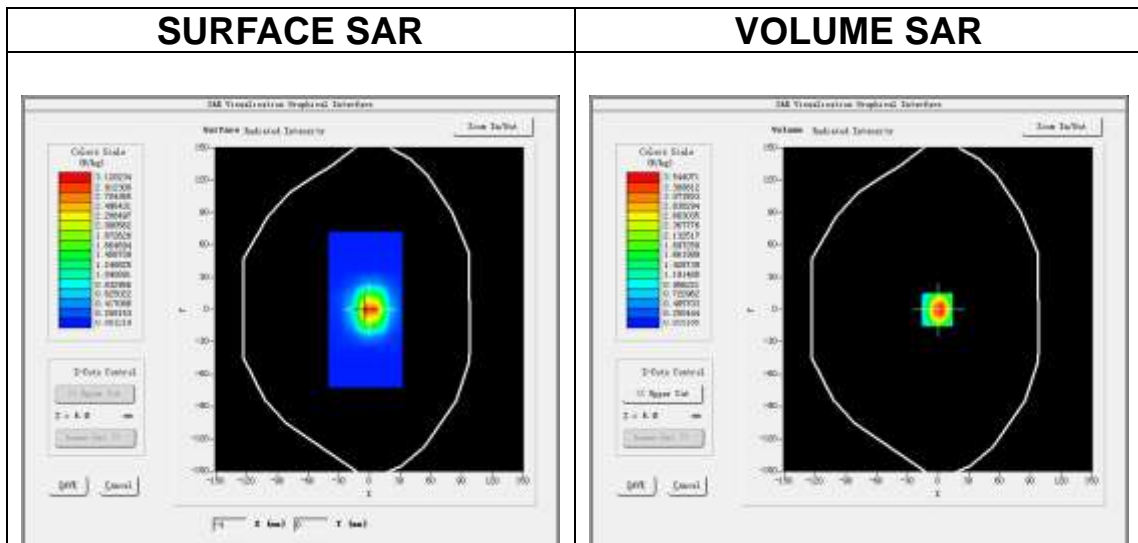

**Maximum location: X=-1.00, Y=0.00**

**SAR Peak: 6.08 W/kg**

<b>SAR 10g (W/Kg)</b>	1.537704
-----------------------	----------

<b>SAR 1g (W/Kg)</b>	<b>3.384757</b>
----------------------	-----------------

<b>Z (mm)</b>	<b>0.00</b>	<b>4.00</b>	<b>9.00</b>	<b>14.00</b>	<b>19.00</b>	<b>24.00</b>	<b>29.00</b>
<b>SAR (W/Kg)</b>	<b>5.9985</b>	<b>3.5441</b>	<b>1.7218</b>	<b>0.8347</b>	<b>0.3998</b>	<b>0.1933</b>	<b>0.0928</b>

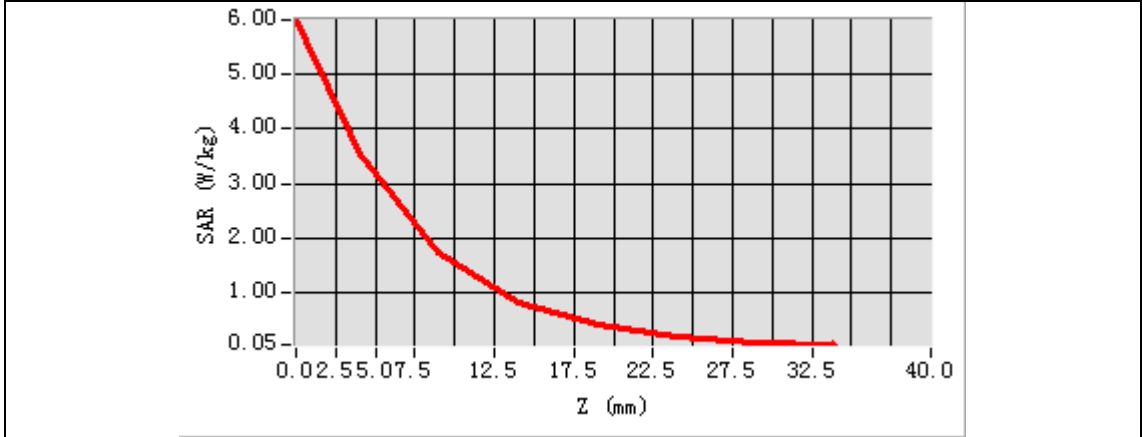

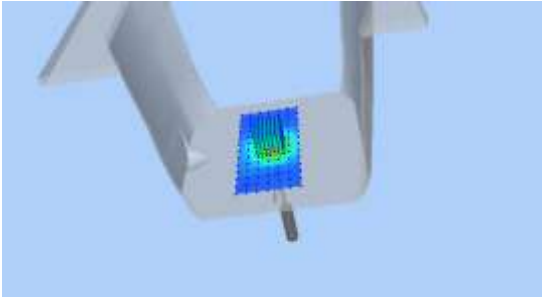
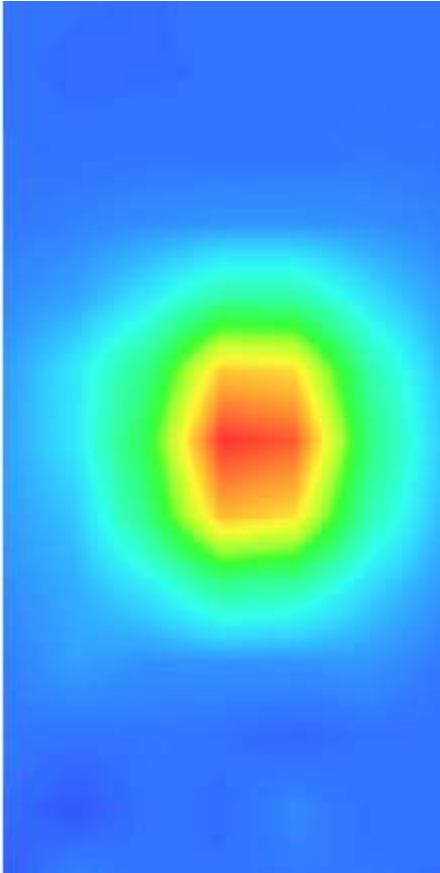
<b>3D screen shot</b>	<b>Hot spot position</b>
	

# MEASUREMENT 7

Date of measurement: 5/10/2024

## A. Experimental conditions.

<b>Area Scan</b>	<u>dx=10mm dy=10mm, h= 2.00 mm</u>
<b>ZoomScan</b>	<u>7x7x12,dx=4mm dy=4mm dz=2mm</u>
<b>Phantom</b>	<u>Validation plane</u>
<b>Device Position</b>	<u>Dipole</u>
<b>Band</b>	<u>CW5200</u>
<b>Channels</b>	<u>Middle</u>
<b>Signal</b>	<u>CW (Crest factor: 1.0)</u>
<b>ConvF</b>	<u>1.89</u>

## B. SAR Measurement Results

<b>Frequency (MHz)</b>	5200.000000
<b>Relative permittivity (real part)</b>	36.747216
<b>Relative permittivity (imaginary part)</b>	15.759931
<b>Conductivity (S/m)</b>	4.552869
<b>Variation (%)</b>	1.700000

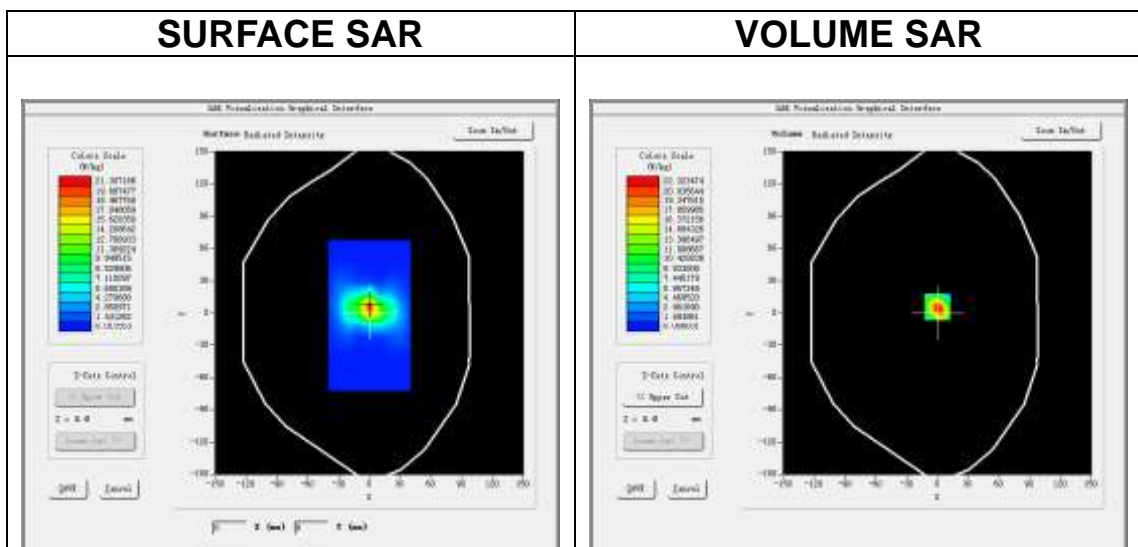

**Maximum location: X=0.00, Y=6.00**

**SAR Peak: 40.06 W/kg**

<b>SAR 10g (W/Kg)</b>	5.563165
<b>SAR 1g (W/Kg)</b>	15.360243

Z (m)	0.00	2.00	4.00	6.00	8.00	10.00	12.00	14.00	16.00	18.00	20.00	22.00
SAR (W/Kg)	37.836	22.321	11.350	5.6649	2.8227	1.4032	0.7196	0.3664	0.1805	0.1069	0.0580	0.0359

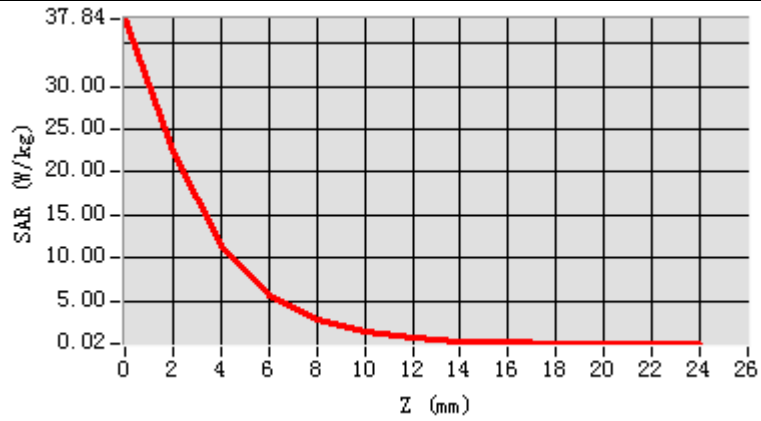

**3D screen shot**

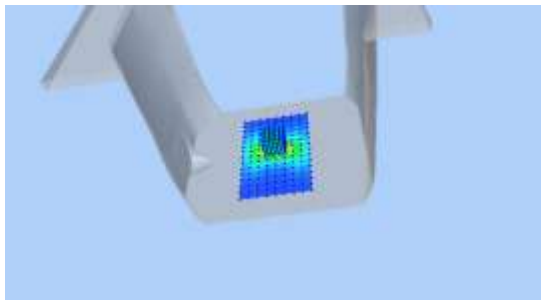

**Hot spot position**

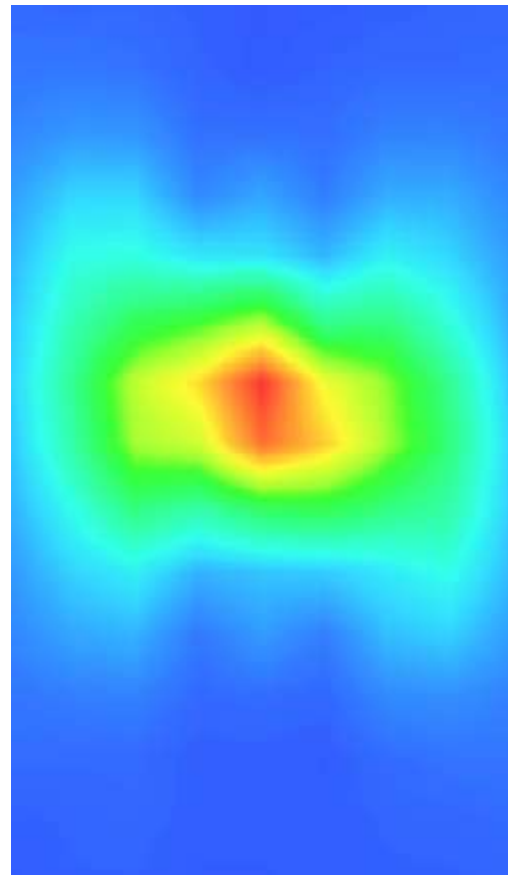

# MEASUREMENT 8

Date of measurement: 7/10/2024

## A. Experimental conditions.

<b>Area Scan</b>	<u>dx=10mm dy=10mm, h= 2.00 mm</u>
<b>ZoomScan</b>	<u>7x7x12,dx=4mm dy=4mm dz=2mm</u>
<b>Phantom</b>	<u>Validation plane</u>
<b>Device Position</b>	<u>Dipole</u>
<b>Band</b>	<u>CW5800</u>
<b>Channels</b>	<u>Middle</u>
<b>Signal</b>	<u>CW (Crest factor: 1.0)</u>
<b>ConvF</b>	<u>1.90</u>

## B. SAR Measurement Results

<b>Frequency (MHz)</b>	5800.000000
<b>Relative permittivity (real part)</b>	35.277500
<b>Relative permittivity (imaginary part)</b>	15.771107
<b>Conductivity (S/m)</b>	5.081801
<b>Variation (%)</b>	-0.760000

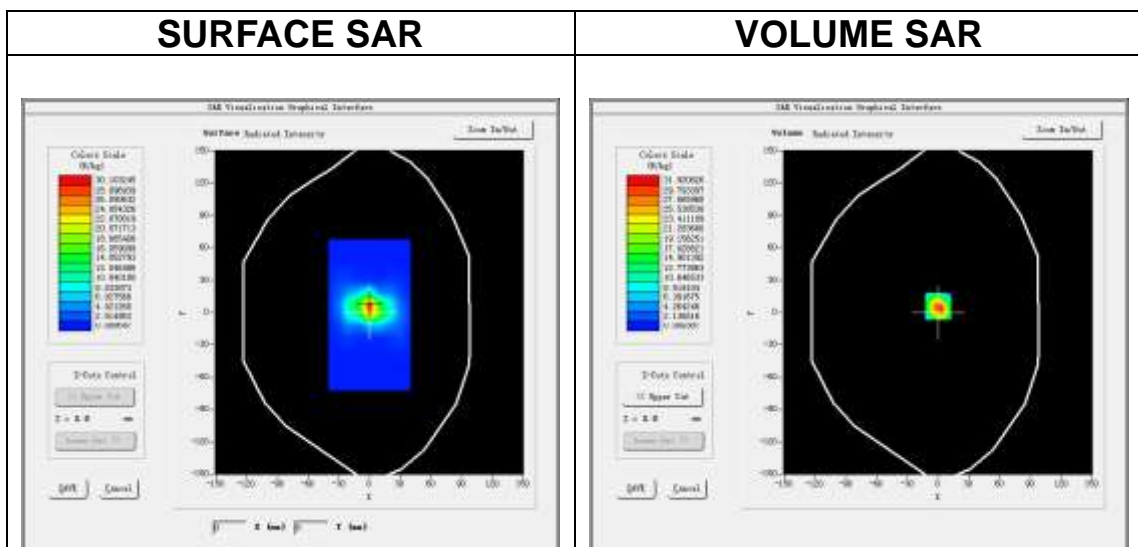

**Maximum location: X=0.00, Y=6.00**  
**SAR Peak: 57.37 W/kg**

<b>SAR 10g (W/Kg)</b>	5.754020
<b>SAR 1g (W/Kg)</b>	18.660031



Z (m)	0.00	2.00	4.00	6.00	8.00	10.00	12.00	14.00	16.00	18.00	20.00	22.00
SAR (W/Kg)	54.020	31.929	16.103	8.1734	4.0814	2.0526	1.0351	0.5196	0.2753	0.1517	0.0747	0.0458

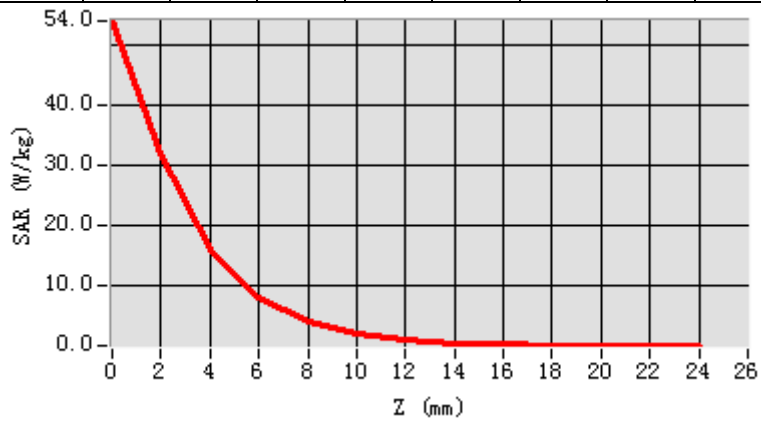

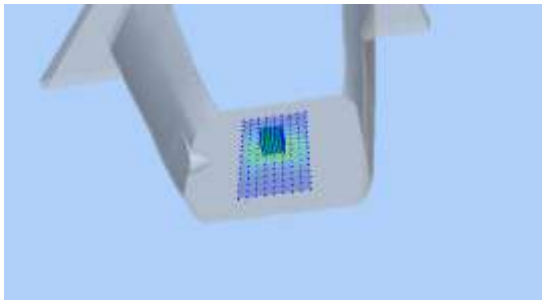
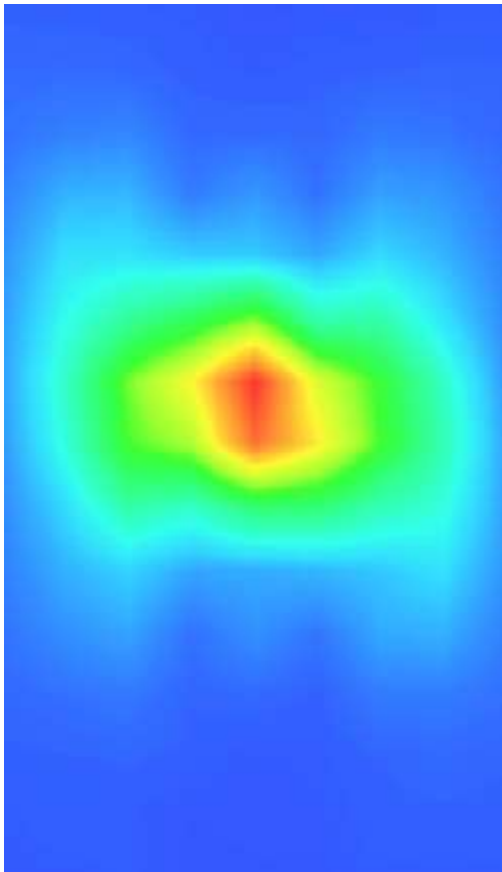
3D screen shot	Hot spot position
	

## 12. Appendix C. Plots of High SAR Measurement

<b>Table of contents</b>
<b>MEASUREMENT 1 GSM 850 Head</b>
<b>MEASUREMENT 2 GSM 850 Body</b>
<b>MEASUREMENT 3 GSM 1900 Head</b>
<b>MEASUREMENT 4 GSM 1900 Body</b>
<b>MEASUREMENT 5 WCDMA Band 2 Head</b>
<b>MEASUREMENT 6 WCDMA Band 2 Body</b>
<b>MEASUREMENT 7 WCDMA Band 4 Head</b>
<b>MEASUREMENT 8 WCDMA Band 4 Body</b>
<b>MEASUREMENT 9 WCDMA Band 5 Head</b>
<b>MEASUREMENT 10 WCDMA Band 5 Body</b>
<b>MEASUREMENT 11 Bluetooth Head</b>
<b>MEASUREMENT 12 Bluetooth Body</b>
<b>MEASUREMENT 13 WLAN 5.2G Head</b>
<b>MEASUREMENT 14 WLAN 5.8G Head</b>
<b>MEASUREMENT 15 WLAN 5.2G Body</b>
<b>MEASUREMENT 16 WLAN 5.8G Body</b>
<b>MEASUREMENT 17 WLAN 2.4G Head</b>
<b>MEASUREMENT 18 WLAN 2.4G Body</b>
<b>MEASUREMENT 19 LTE Band 2 Head</b>
<b>MEASUREMENT 20 LTE Band 2 Body</b>
<b>MEASUREMENT 21 LTE Band 4 Head</b>
<b>MEASUREMENT 22 LTE Band 4 Body</b>
<b>MEASUREMENT 23 LTE Band 5 Head</b>
<b>MEASUREMENT 24 LTE Band 5 Body</b>
<b>MEASUREMENT 25 LTE Band 7 Head</b>
<b>MEASUREMENT 26 LTE Band 7 Body</b>
<b>MEASUREMENT 27 LTE Band 12 Head</b>
<b>MEASUREMENT 28 LTE Band 12 Body</b>
<b>MEASUREMENT 29 LTE Band 17 Head</b>
<b>MEASUREMENT 30 LTE Band 17 Body</b>
<b>MEASUREMENT 31 LTE Band 41 Head</b>
<b>MEASUREMENT 32 LTE Band 41 Body</b>
<b>MEASUREMENT 33 LTE Band 66 Head</b>
<b>MEASUREMENT 34 LTE Band 66 Body</b>

# MEASUREMENT 1

Date of measurement: 10/10/2024

## A. Experimental conditions.

<b>Area Scan</b>	<u>dx=15mm dy=15mm, h= 5.00 mm</u>
<b>ZoomScan</b>	<u>5x5x7,dx=8mm dy=8mm dz=5mm</u>
<b>Phantom</b>	<u>Left head</u>
<b>Device Position</b>	<u>Cheek</u>
<b>Band</b>	<u>GSM850</u>
<b>Channels</b>	<u>Middle</u>
<b>Signal</b>	<u>TDMA (Crest factor: 8.0)</u>
<b>ConvF</b>	<u>2.34</u>

## B. SAR Measurement Results

<b>Frequency (MHz)</b>	836.400000
<b>Relative permittivity (real part)</b>	42.005749
<b>Relative permittivity (imaginary part)</b>	19.848530
<b>Conductivity (S/m)</b>	0.922295
<b>Variation (%)</b>	2.140000

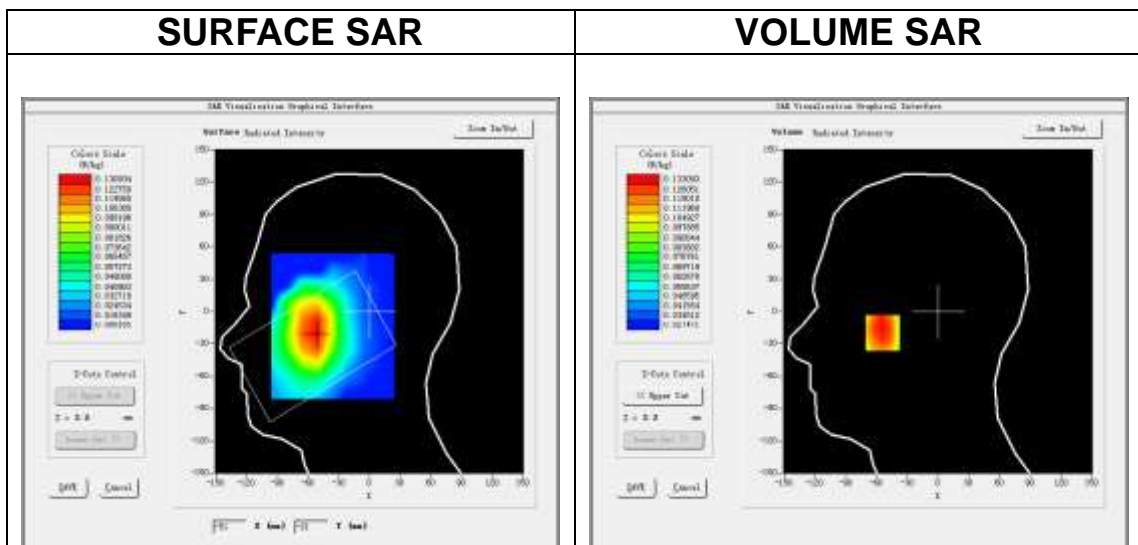

**Maximum location: X=-54.00, Y=-19.00**

**SAR Peak: 0.16 W/kg**

<b>SAR 10g (W/Kg)</b>	0.107452
<b>SAR 1g (W/Kg)</b>	0.129919

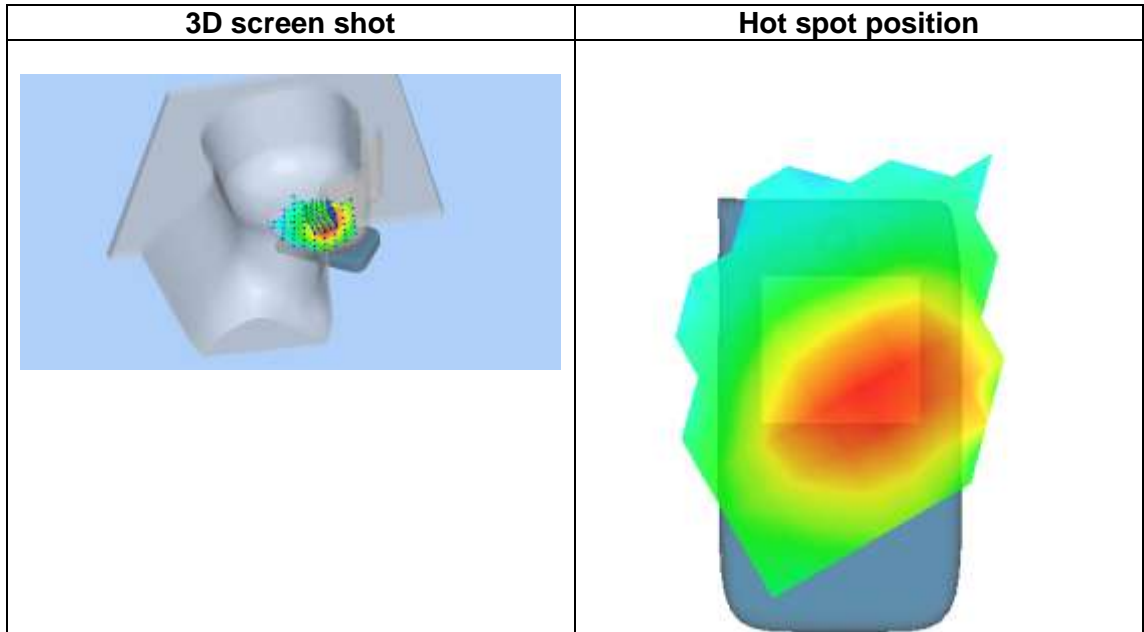
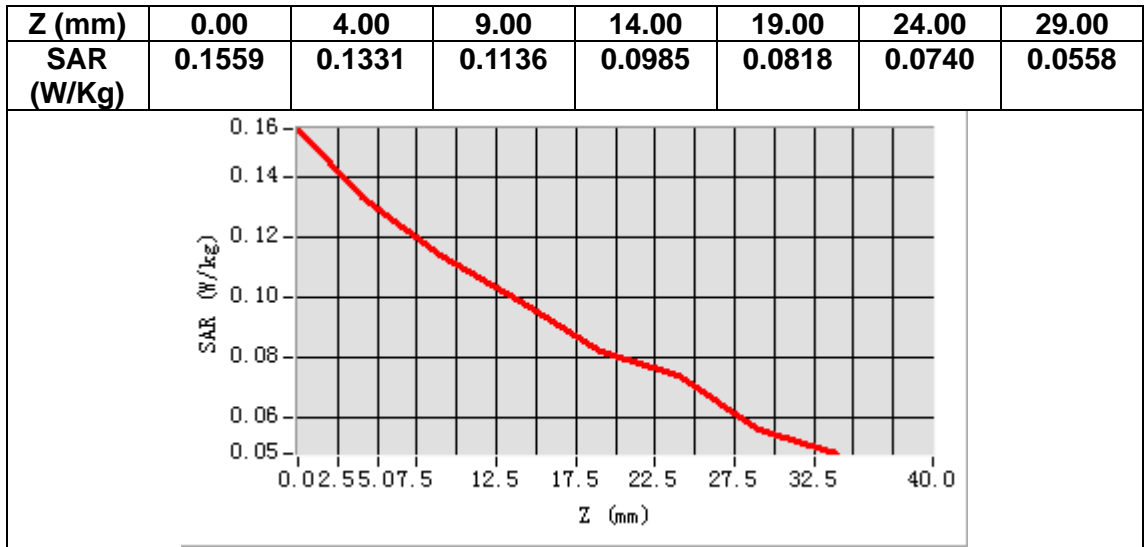

# MEASUREMENT 2

Date of measurement: 10/10/2024

## A. Experimental conditions.

<b>Area Scan</b>	<u>dx=15mm dy=15mm, h= 5.00 mm</u>
<b>ZoomScan</b>	<u>5x5x7,dx=8mm dy=8mm dz=5mm</u>
<b>Phantom</b>	<u>Validation plane</u>
<b>Device Position</b>	<u>Body</u>
<b>Band</b>	<u>GSM850</u>
<b>Channels</b>	<u>Middle</u>
<b>Signal</b>	<u>TDMA (Crest factor: 8.0)</u>
<b>ConvF</b>	<u>2.34</u>

## B. SAR Measurement Results

<b>Frequency (MHz)</b>	836.400000
<b>Relative permittivity (real part)</b>	42.005749
<b>Relative permittivity (imaginary part)</b>	19.848530
<b>Conductivity (S/m)</b>	0.922295
<b>Variation (%)</b>	1.130000

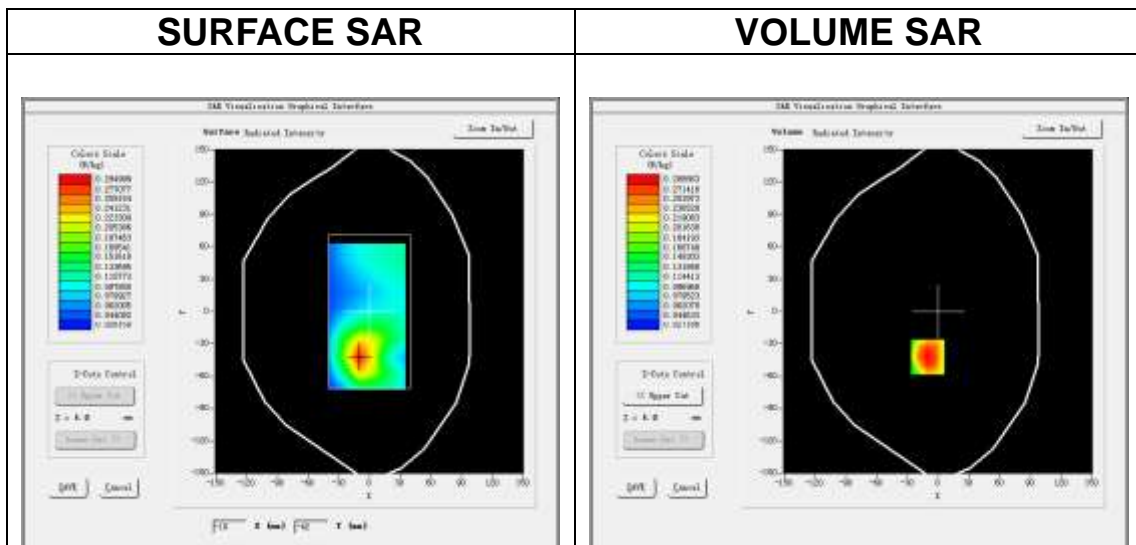

**Maximum location: X=-10.00, Y=-42.00**  
**SAR Peak: 0.41 W/kg**

<b>SAR 10g (W/Kg)</b>	0.180050
<b>SAR 1g (W/Kg)</b>	0.282143

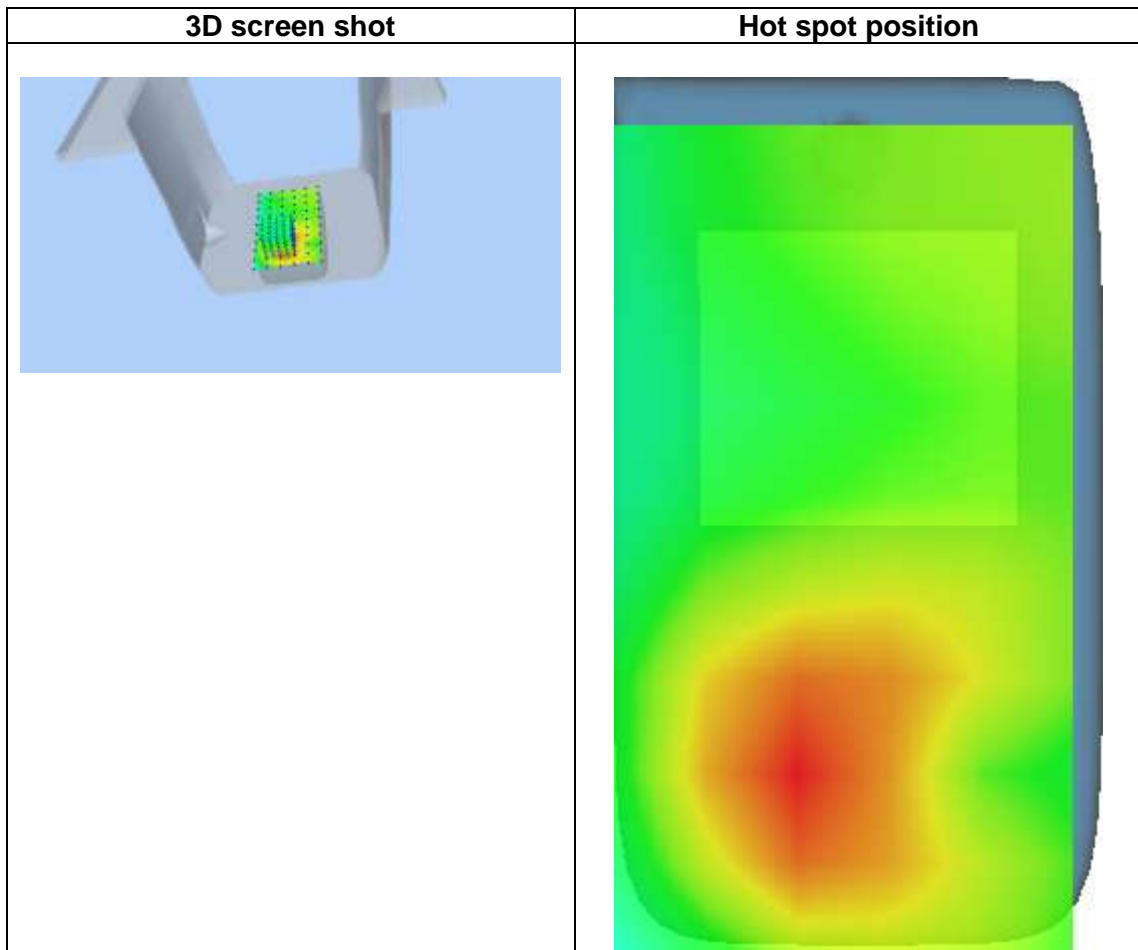
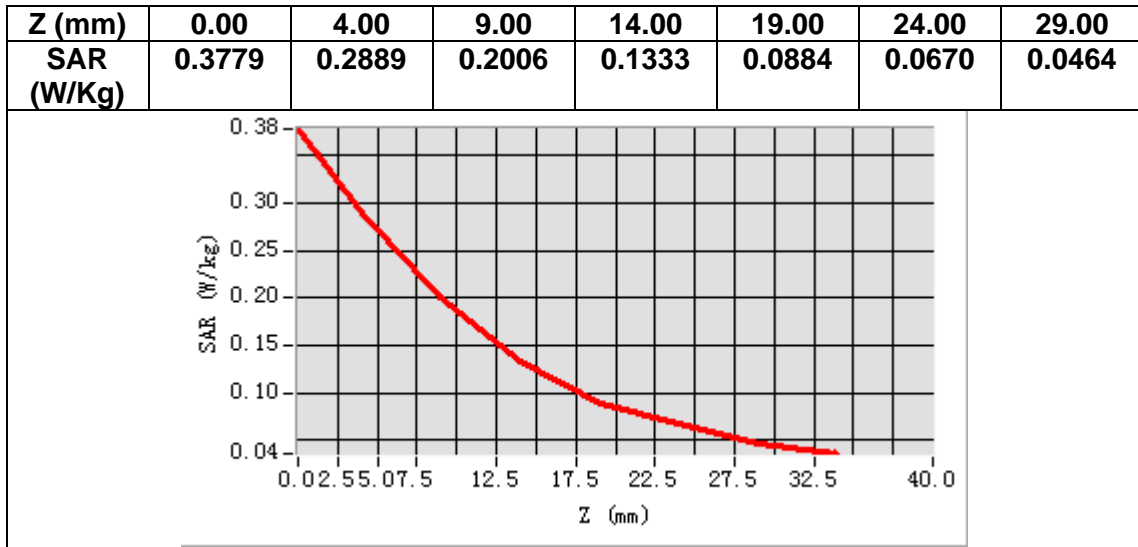

# MEASUREMENT 3

Date of measurement: 12/10/2024

## A. Experimental conditions.

<b>Area Scan</b>	<u>dx=15mm dy=15mm, h= 5.00 mm</u>
<b>ZoomScan</b>	<u>5x5x7,dx=8mm dy=8mm dz=5mm</u>
<b>Phantom</b>	<u>Left head</u>
<b>Device Position</b>	<u>Cheek</u>
<b>Band</b>	<u>GSM1900</u>
<b>Channels</b>	<u>Middle</u>
<b>Signal</b>	<u>TDMA (Crest factor: 8.0)</u>
<b>ConvF</b>	<u>2.57</u>

## B. SAR Measurement Results

<b>Frequency (MHz)</b>	1880.000000
<b>Relative permittivity (real part)</b>	38.526512
<b>Relative permittivity (imaginary part)</b>	13.733387
<b>Conductivity (S/m)</b>	1.434376
<b>Variation (%)</b>	-1.820000

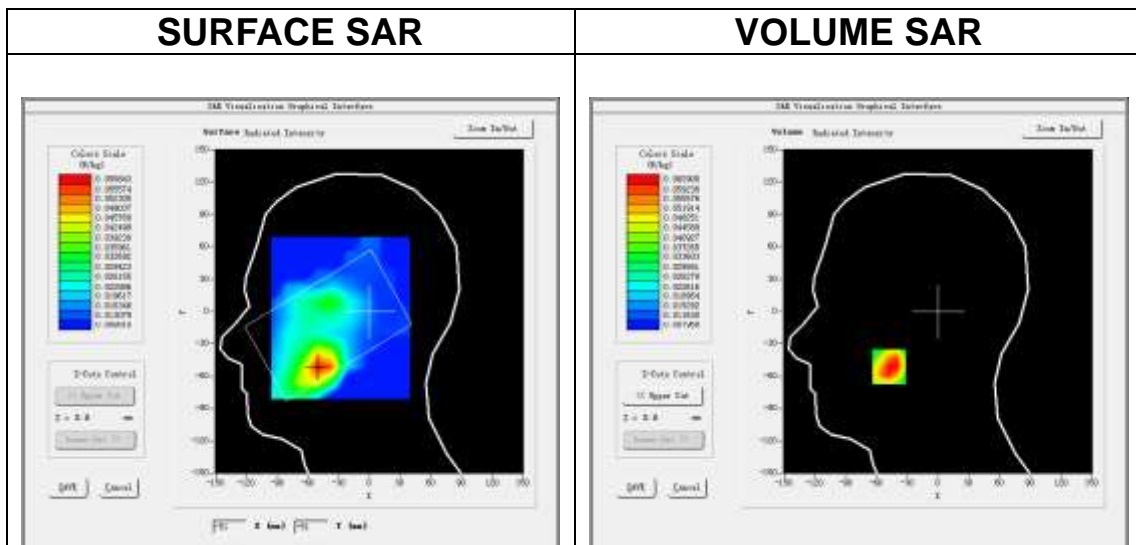

**Maximum location: X=-48.00, Y=-51.00**  
**SAR Peak: 0.09 W/kg**

<b>SAR 10g (W/Kg)</b>	0.041117
<b>SAR 1g (W/Kg)</b>	0.062181

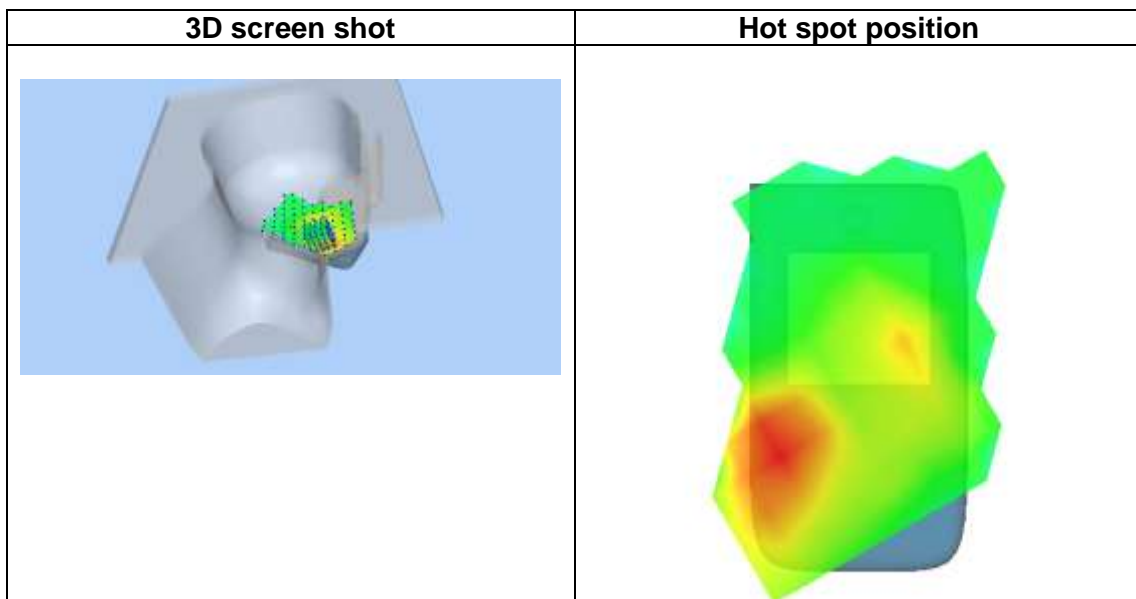
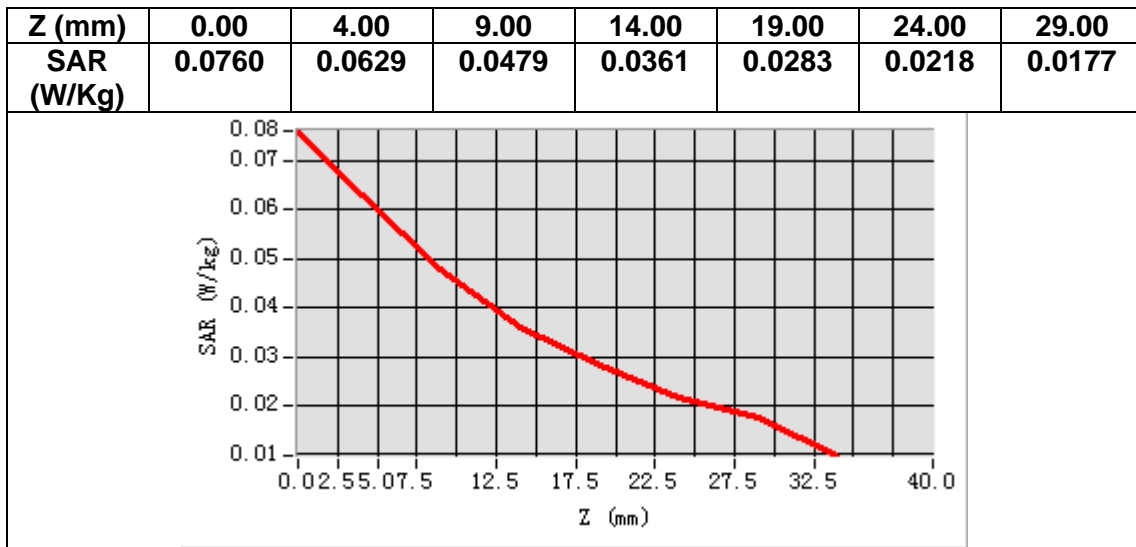



# MEASUREMENT 4

Date of measurement: 12/10/2024

## A. Experimental conditions.

<b>Area Scan</b>	<u>dx=15mm dy=15mm, h= 5.00 mm</u>
<b>ZoomScan</b>	<u>5x5x7, dx=8mm dy=8mm dz=5mm</u>
<b>Phantom</b>	<u>Validation plane</u>
<b>Device Position</b>	<u>Body</u>
<b>Band</b>	<u>GSM1900</u>
<b>Channels</b>	<u>Middle</u>
<b>Signal</b>	<u>TDMA (Crest factor: 8.0)</u>
<b>ConvF</b>	<u>2.57</u>

## B. SAR Measurement Results

<b>Frequency (MHz)</b>	1880.000000
<b>Relative permittivity (real part)</b>	38.526512
<b>Relative permittivity (imaginary part)</b>	13.733387
<b>Conductivity (S/m)</b>	1.434376
<b>Variation (%)</b>	-2.120000

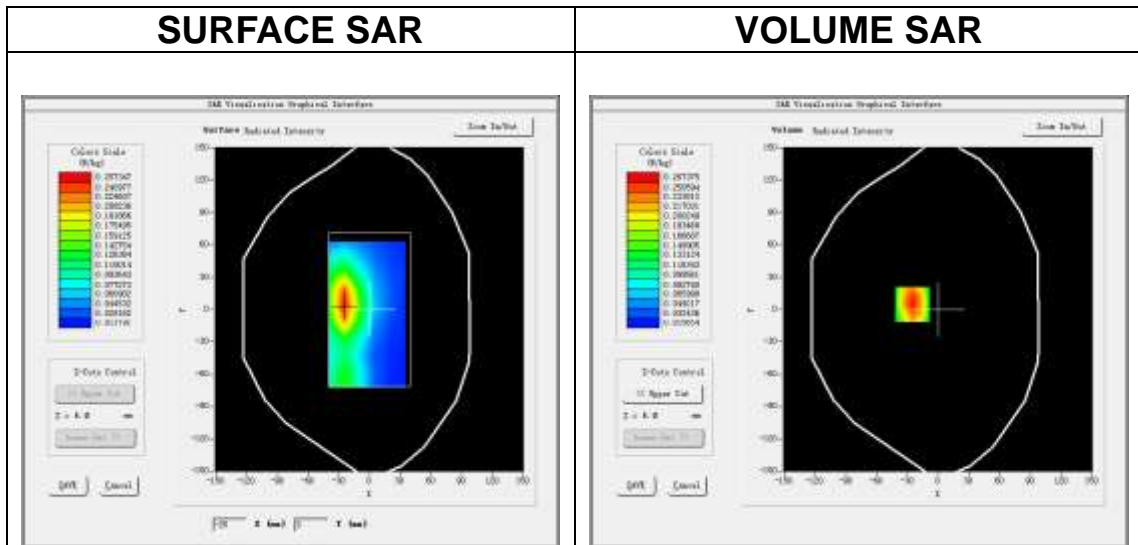

**Maximum location: X=-25.00, Y=5.00**  
**SAR Peak: 0.40 W/kg**

<b>SAR 10g (W/Kg)</b>	0.151497
<b>SAR 1g (W/Kg)</b>	0.259724

Z (mm)	0.00	4.00	9.00	14.00	19.00	24.00	29.00
SAR (W/Kg)	0.3929	0.2674	0.1646	0.1004	0.0687	0.0424	0.0323

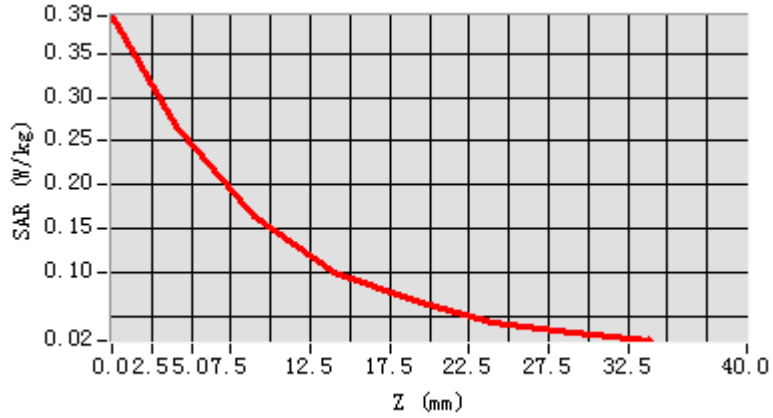

**3D screen shot**

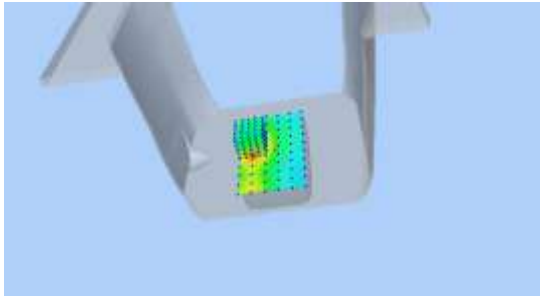

**Hot spot position**

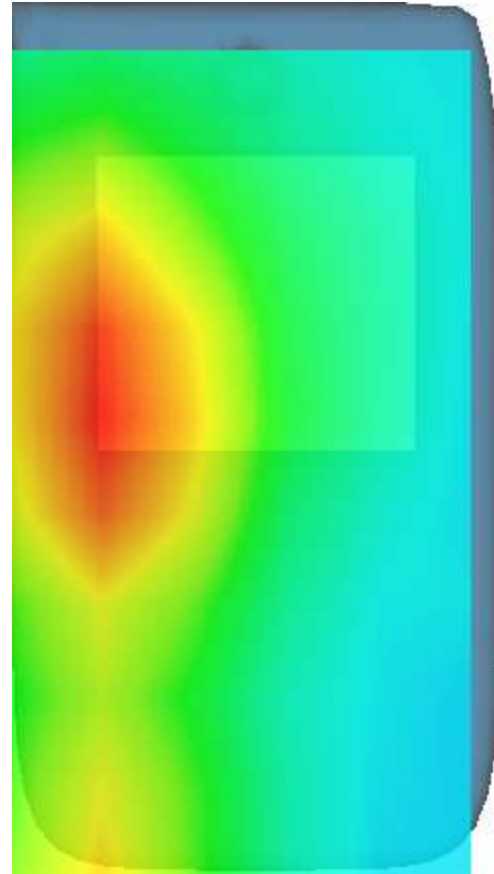

# MEASUREMENT 5

Date of measurement: 12/10/2024

## A. Experimental conditions.

<b>Area Scan</b>	<u>dx=15mm dy=15mm, h= 5.00 mm</u>
<b>ZoomScan</b>	<u>5x5x7,dx=8mm dy=8mm dz=5mm</u>
<b>Phantom</b>	<u>Left head</u>
<b>Device Position</b>	<u>Cheek</u>
<b>Band</b>	<u>Band2_WCDMA1900</u>
<b>Channels</b>	<u>Middle</u>
<b>Signal</b>	<u>WCDMA (Crest factor: 1.0)</u>
<b>ConvF</b>	<u>2.57</u>

## B. SAR Measurement Results

<b>Frequency (MHz)</b>	1880.000000
<b>Relative permittivity (real part)</b>	38.526512
<b>Relative permittivity (imaginary part)</b>	13.733387
<b>Conductivity (S/m)</b>	1.434376
<b>Variation (%)</b>	2.060000

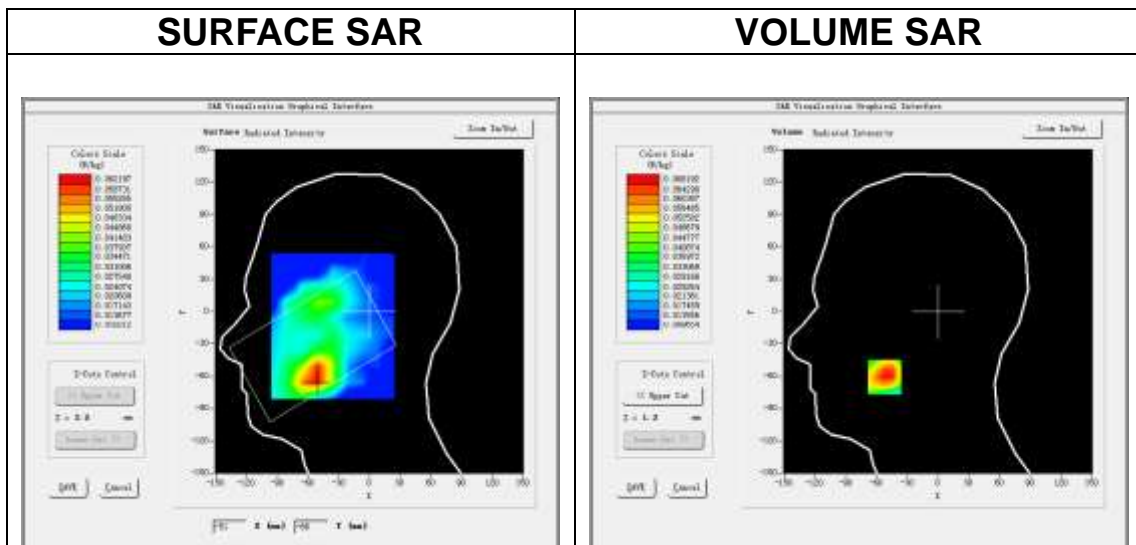

**Maximum location: X=-52.00, Y=-61.00**  
**SAR Peak: 0.09 W/kg**

<b>SAR 10g (W/Kg)</b>	0.044281
<b>SAR 1g (W/Kg)</b>	0.068516

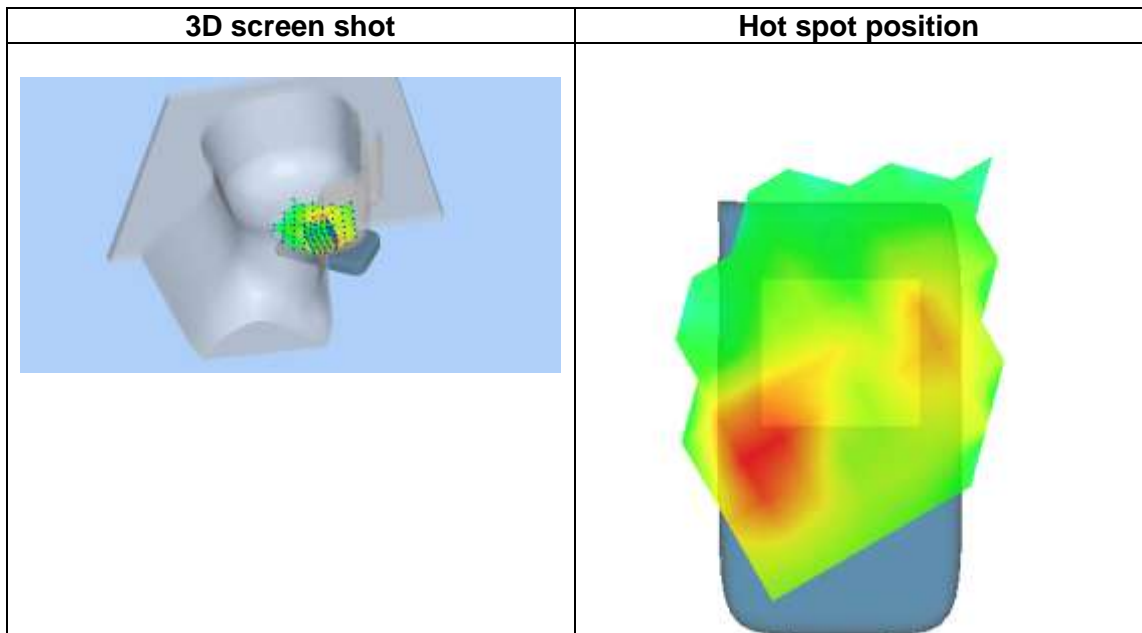
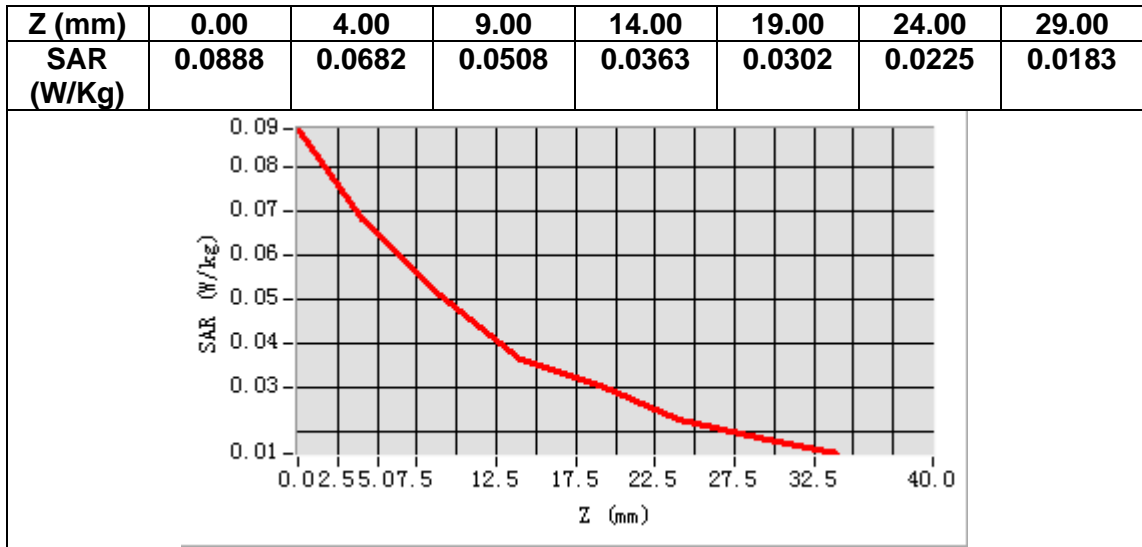

# MEASUREMENT 6

Date of measurement: 12/10/2024

## A. Experimental conditions.

<b>Area Scan</b>	<u>dx=15mm dy=15mm, h= 5.00 mm</u>
<b>ZoomScan</b>	<u>5x5x7,dx=8mm dy=8mm dz=5mm</u>
<b>Phantom</b>	<u>Validation plane</u>
<b>Device Position</b>	<u>Body</u>
<b>Band</b>	<u>Band2_WCDMA1900</u>
<b>Channels</b>	<u>Middle</u>
<b>Signal</b>	<u>WCDMA (Crest factor: 1.0)</u>
<b>ConvF</b>	<u>2.57</u>

## B. SAR Measurement Results

<b>Frequency (MHz)</b>	1880.000000
<b>Relative permittivity (real part)</b>	38.526512
<b>Relative permittivity (imaginary part)</b>	13.733387
<b>Conductivity (S/m)</b>	1.434376
<b>Variation (%)</b>	0.140000

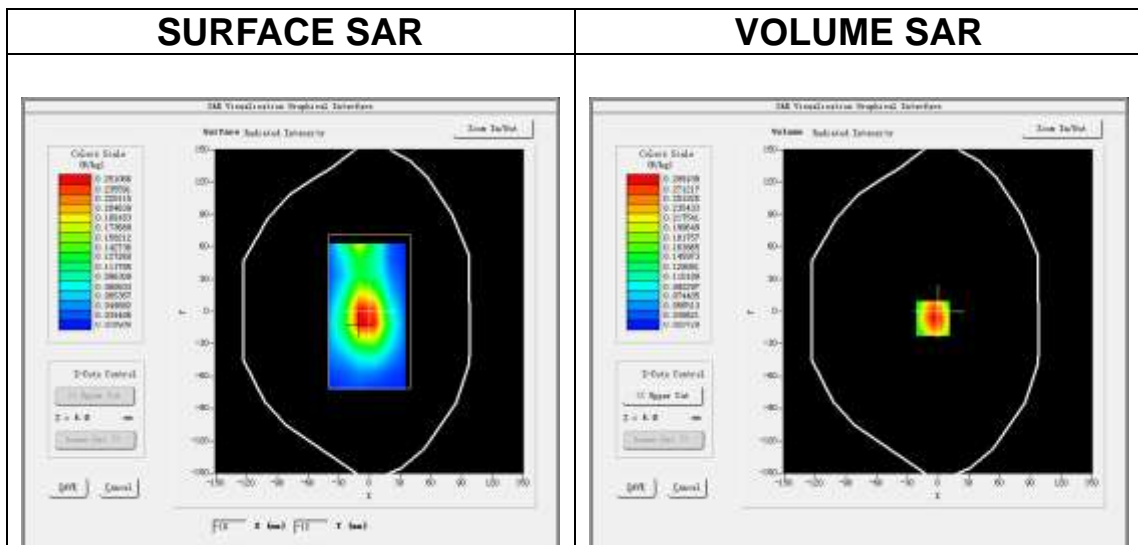

**Maximum location: X=-5.00, Y=-6.00**  
**SAR Peak: 0.43 W/kg**

<b>SAR 10g (W/Kg)</b>	0.168153
<b>SAR 1g (W/Kg)</b>	0.285763

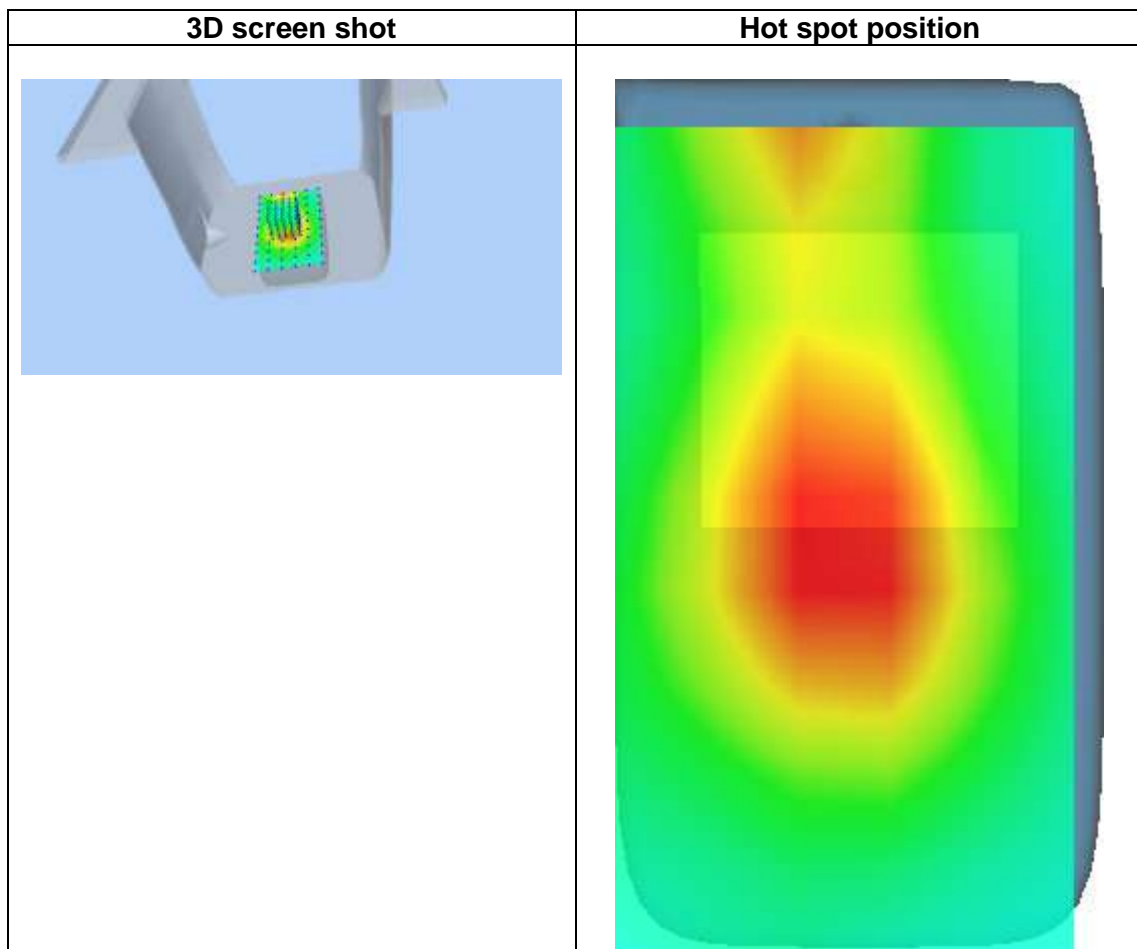
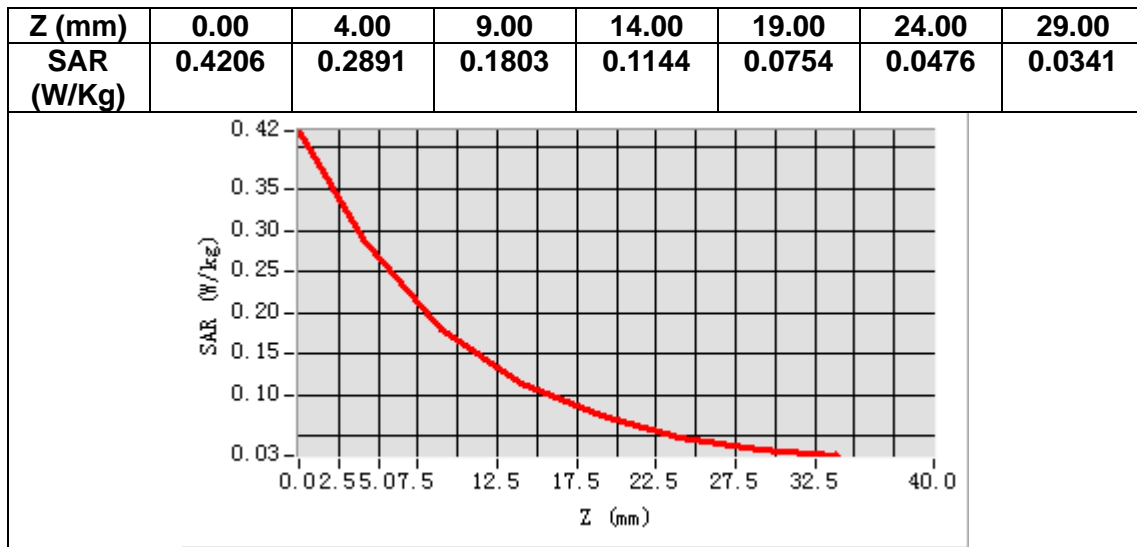

# MEASUREMENT 7

Date of measurement: 13/9/2024

## A. Experimental conditions.

<b>Area Scan</b>	<u>dx=15mm dy=15mm, h= 5.00 mm</u>
<b>ZoomScan</b>	<u>5x5x7,dx=8mm dy=8mm dz=5mm</u>
<b>Phantom</b>	<u>Left head</u>
<b>Device Position</b>	<u>Cheek</u>
<b>Band</b>	<u>Band4 WCDMA1700</u>
<b>Channels</b>	<u>Middle</u>
<b>Signal</b>	<u>WCDMA (Crest factor: 1.0)</u>
<b>ConvF</b>	<u>2.45</u>

## B. SAR Measurement Results

<b>Frequency (MHz)</b>	1732.600000
<b>Relative permittivity (real part)</b>	39.780106
<b>Relative permittivity (imaginary part)</b>	13.694489
<b>Conductivity (S/m)</b>	1.317714
<b>Variation (%)</b>	0.610000

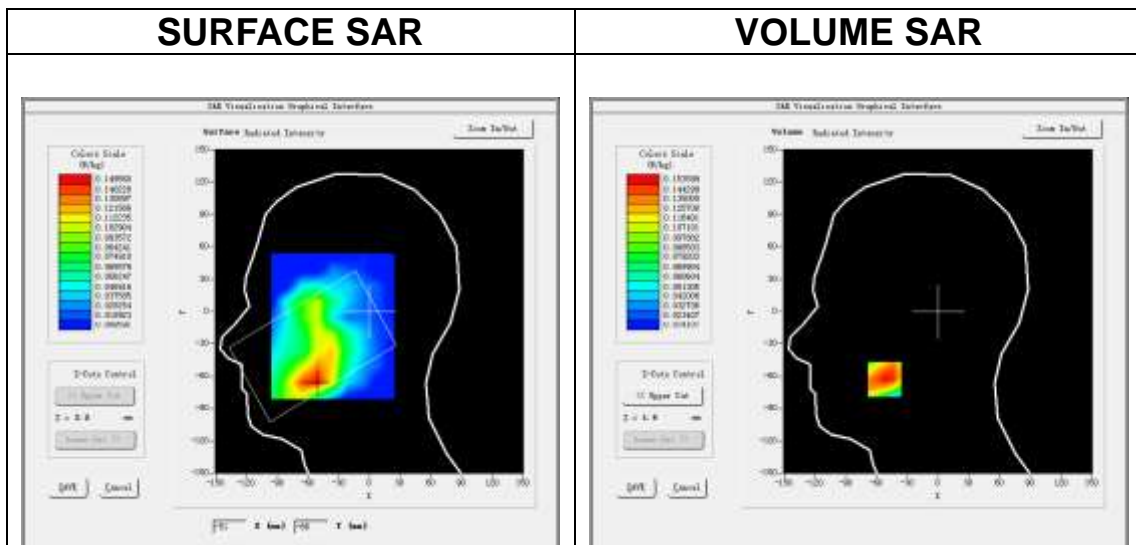

**Maximum location: X=-52.00, Y=-63.00**  
**SAR Peak: 0.20 W/kg**

<b>SAR 10g (W/Kg)</b>	0.099624
<b>SAR 1g (W/Kg)</b>	0.147336

Z (mm)	0.00	4.00	9.00	14.00	19.00	24.00	29.00
SAR (W/Kg)	0.1985	0.1536	0.1119	0.0830	0.0640	0.0489	0.0394

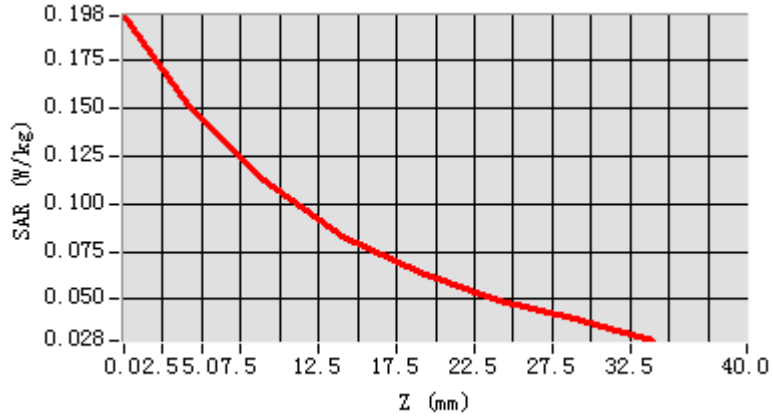

3D screen shot	Hot spot position



# MEASUREMENT 8

Date of measurement: 13/9/2024

## A. Experimental conditions.

<b>Area Scan</b>	<u>dx=15mm dy=15mm, h= 5.00 mm</u>
<b>ZoomScan</b>	<u>5x5x7,dx=8mm dy=8mm dz=5mm</u>
<b>Phantom</b>	<u>Validation plane</u>
<b>Device Position</b>	<u>Body</u>
<b>Band</b>	<u>Band4 WCDMA1700</u>
<b>Channels</b>	<u>Middle</u>
<b>Signal</b>	<u>WCDMA (Crest factor: 1.0)</u>
<b>ConvF</b>	<u>2.45</u>

## B. SAR Measurement Results

<b>Frequency (MHz)</b>	1732.600000
<b>Relative permittivity (real part)</b>	39.780106
<b>Relative permittivity (imaginary part)</b>	13.694489
<b>Conductivity (S/m)</b>	1.317714
<b>Variation (%)</b>	-0.210000

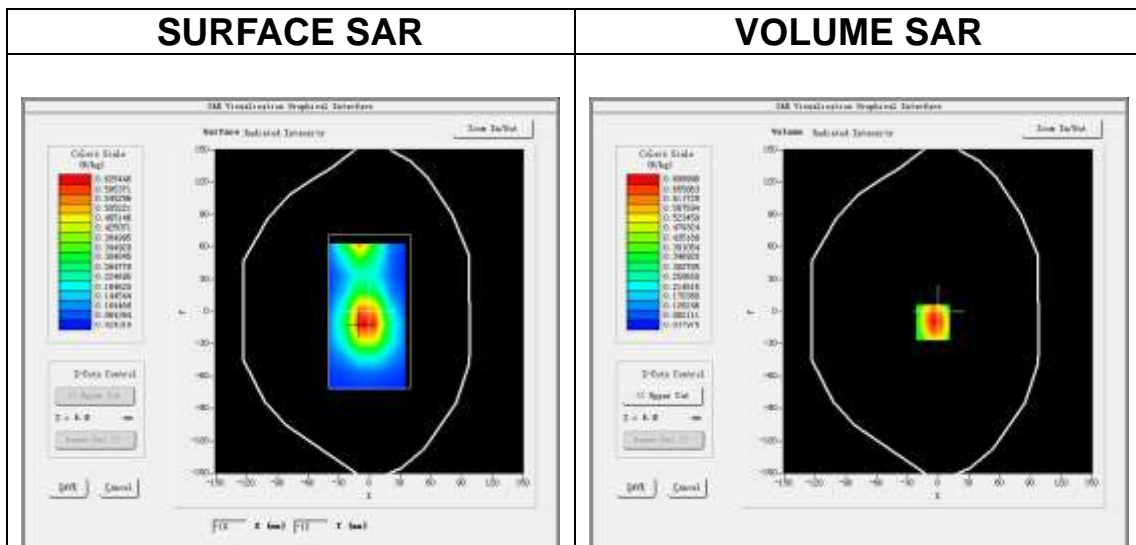

**Maximum location: X=-5.00, Y=-10.00**  
**SAR Peak: 1.02 W/kg**

<b>SAR 10g (W/Kg)</b>	0.404930
<b>SAR 1g (W/Kg)</b>	0.674111

Z (mm)	0.00	4.00	9.00	14.00	19.00	24.00	29.00
SAR (W/Kg)	1.0042	0.7000	0.4455	0.2926	0.1929	0.1276	0.0864

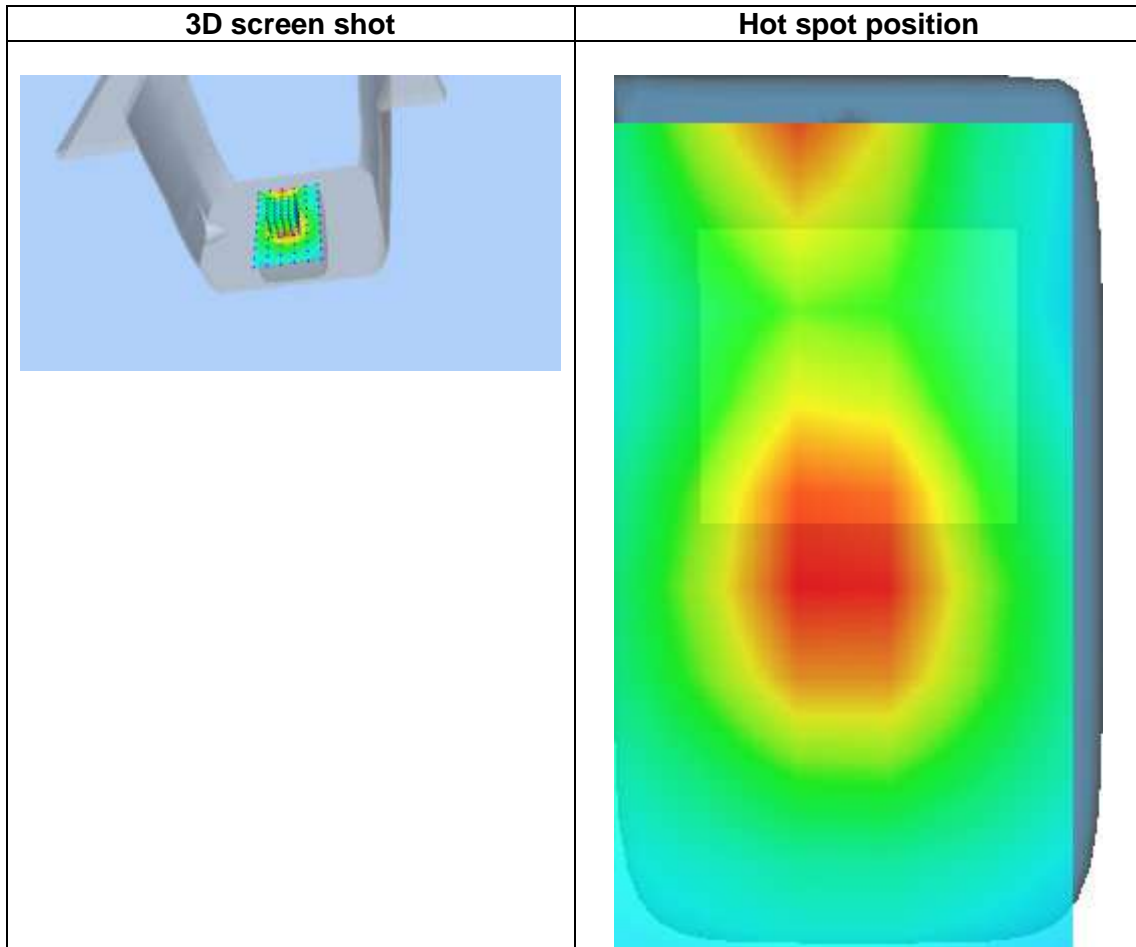
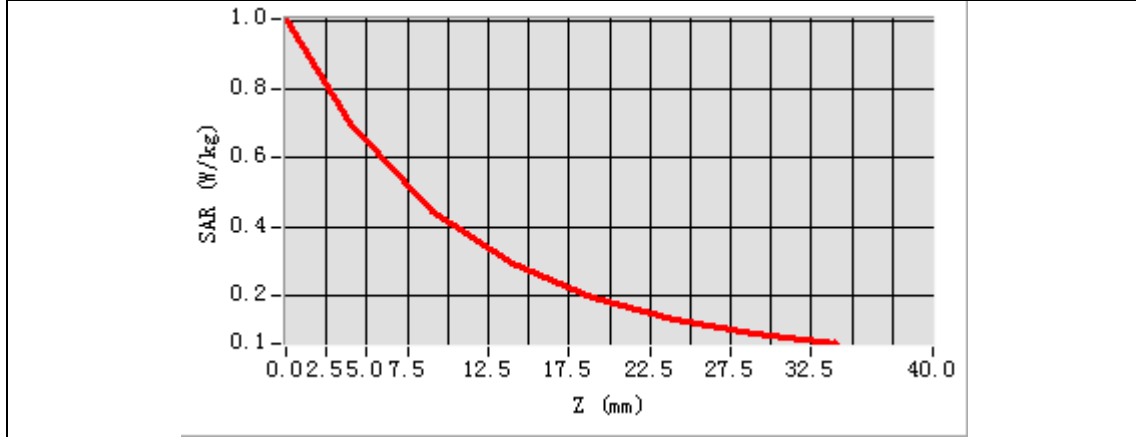

# MEASUREMENT 9

Date of measurement: 10/10/2024

## A. Experimental conditions.

<b>Area Scan</b>	<u>dx=15mm dy=15mm, h= 5.00 mm</u>
<b>ZoomScan</b>	<u>5x5x7, dx=8mm dy=8mm dz=5mm</u>
<b>Phantom</b>	<u>Left head</u>
<b>Device Position</b>	<u>Cheek</u>
<b>Band</b>	<u>Band5_WCDMA850</u>
<b>Channels</b>	<u>Middle</u>
<b>Signal</b>	<u>WCDMA (Crest factor: 1.0)</u>
<b>ConvF</b>	<u>2.34</u>

## B. SAR Measurement Results

<b>Frequency (MHz)</b>	836.400000
<b>Relative permittivity (real part)</b>	40.482819
<b>Relative permittivity (imaginary part)</b>	21.561506
<b>Conductivity (S/m)</b>	1.001891
<b>Variation (%)</b>	-0.600000

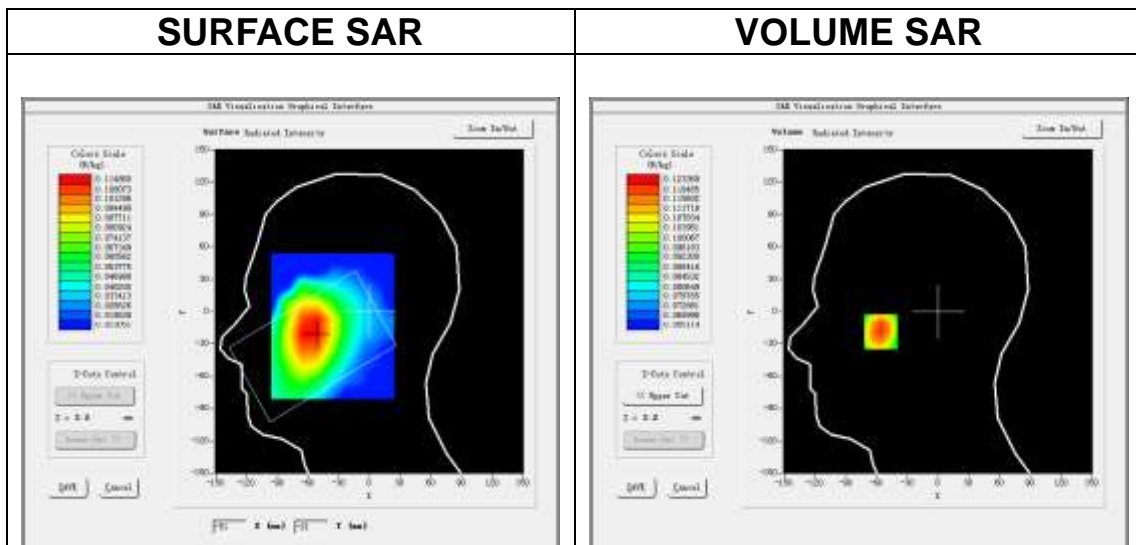

**Maximum location: X=-56.00, Y=-18.00**  
**SAR Peak: 0.12 W/kg**

<b>SAR 10g (W/Kg)</b>	0.120952
<b>SAR 1g (W/Kg)</b>	0.130167

Z (mm)	0.00	4.00	9.00	14.00	19.00	24.00	29.00
SAR (W/Kg)	3.5327	0.1234	0.1214	0.1186	0.1092	0.1049	0.1001

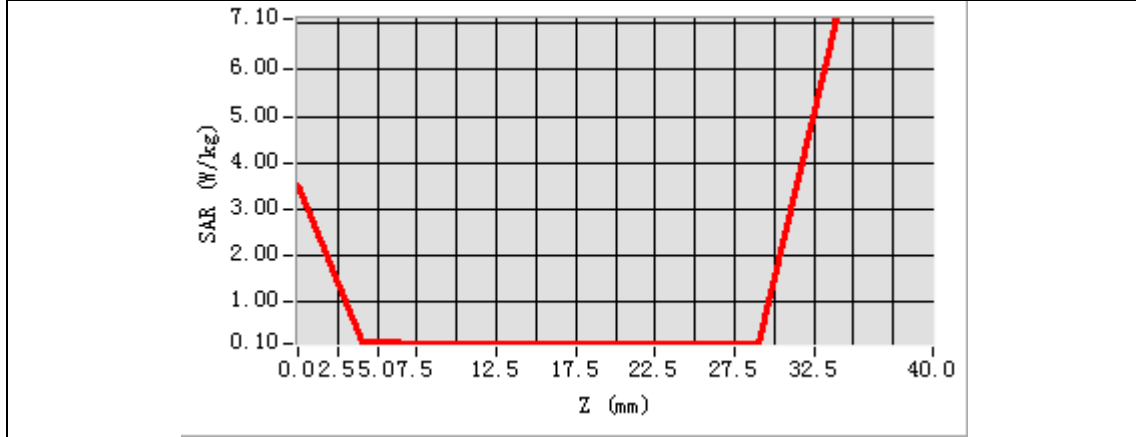

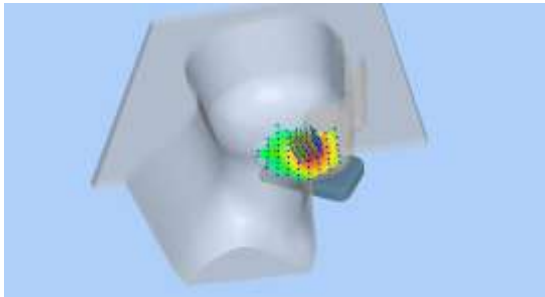
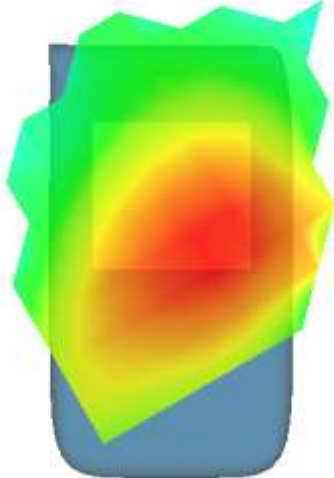
3D screen shot	Hot spot position
	

# MEASUREMENT 10

Date of measurement: 10/10/2024

## A. Experimental conditions.

<b>Area Scan</b>	<u>dx=15mm dy=15mm, h= 5.00 mm</u>
<b>ZoomScan</b>	<u>5x5x7,dx=8mm dy=8mm dz=5mm</u>
<b>Phantom</b>	<u>Validation plane</u>
<b>Device Position</b>	<u>Body</u>
<b>Band</b>	<u>Band5_WCDMA850</u>
<b>Channels</b>	<u>Middle</u>
<b>Signal</b>	<u>WCDMA (Crest factor: 1.0)</u>
<b>ConvF</b>	<u>2.34</u>

## B. SAR Measurement Results

<b>Frequency (MHz)</b>	836.400000
<b>Relative permittivity (real part)</b>	42.005749
<b>Relative permittivity (imaginary part)</b>	19.848530
<b>Conductivity (S/m)</b>	0.922295
<b>Variation (%)</b>	-0.940000

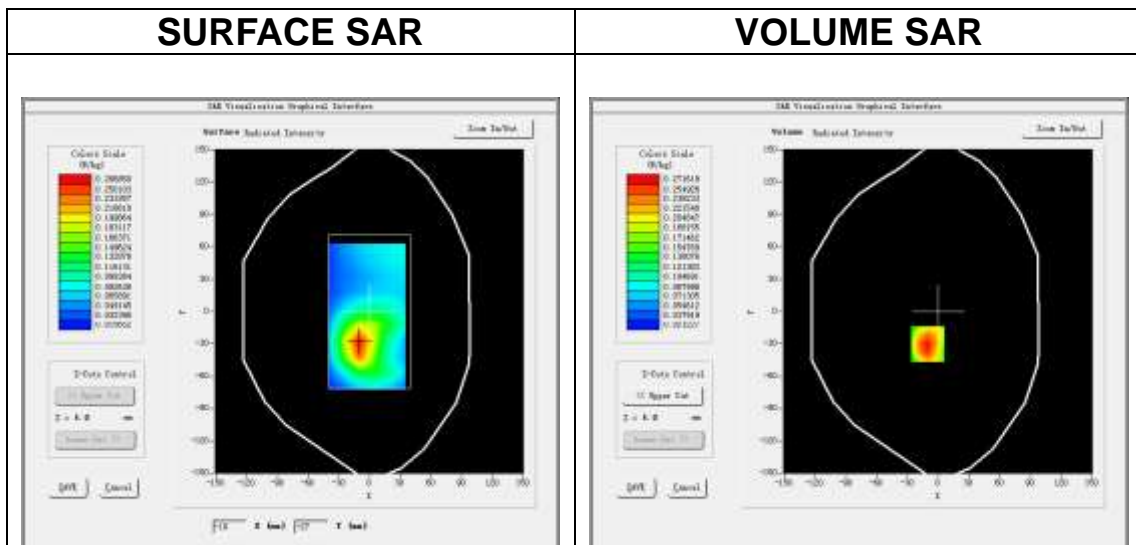

**Maximum location: X=-10.00, Y=-30.00**  
**SAR Peak: 0.39 W/kg**

<b>SAR 10g (W/Kg)</b>	0.162666
<b>SAR 1g (W/Kg)</b>	0.264031

Z (mm)	0.00	4.00	9.00	14.00	19.00	24.00	29.00
SAR (W/Kg)	0.3846	0.2716	0.1764	0.1186	0.0807	0.0551	0.0395

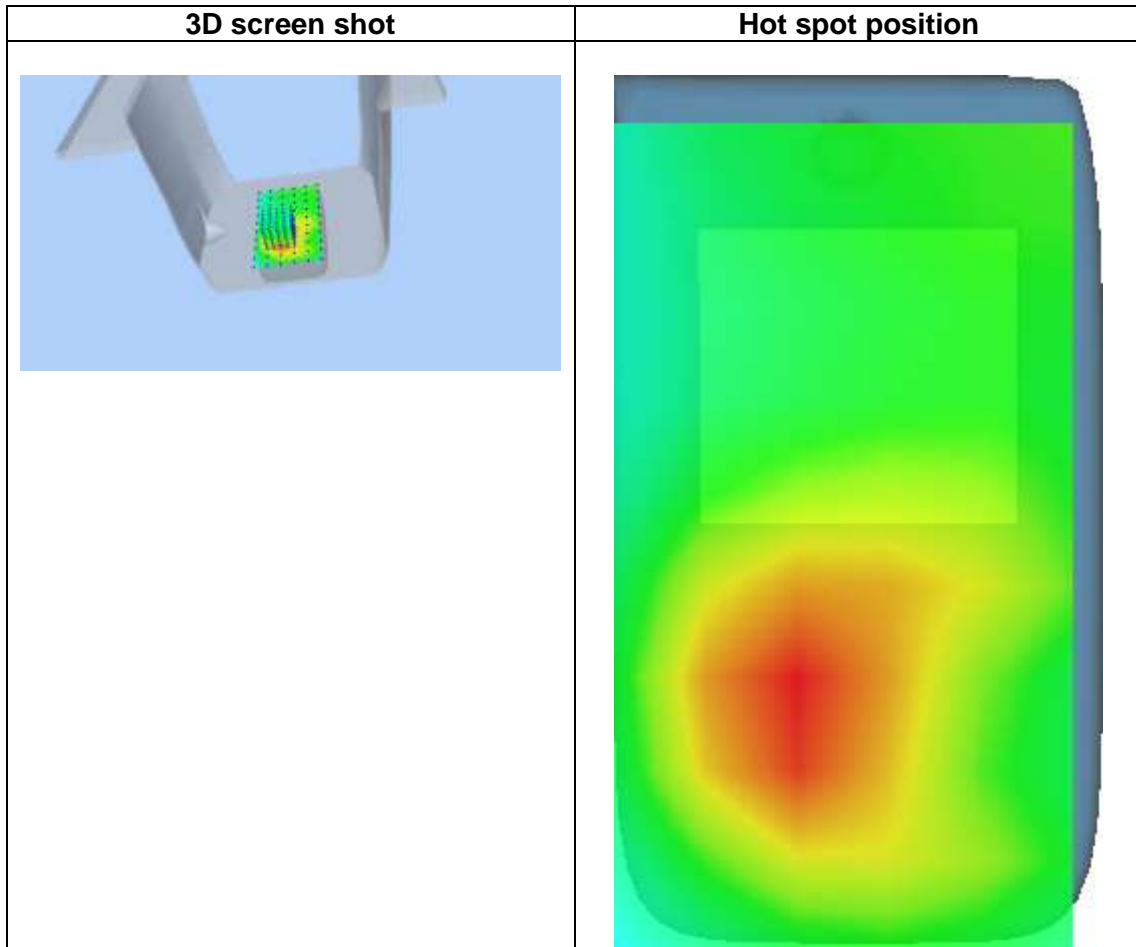
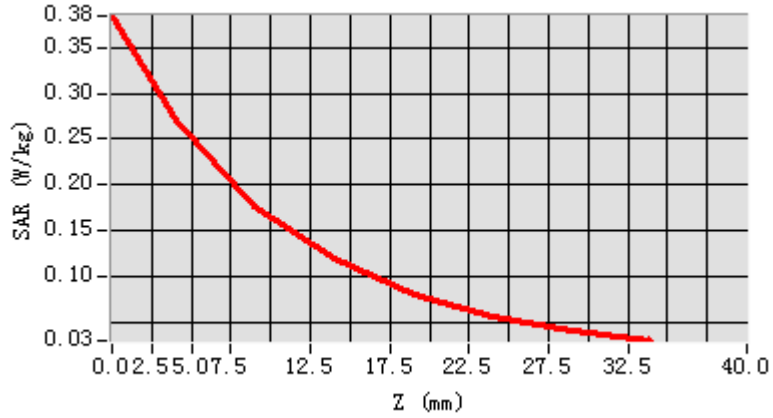

# MEASUREMENT 11

Date of measurement: 16/9/2024

## A. Experimental conditions.

<b>Area Scan</b>	<u>dx=12mm dy=12mm, h= 5.00 mm</u>
<b>ZoomScan</b>	<u>7x7x7,dx=5mm dy=5mm dz=5mm</u>
<b>Phantom</b>	<u>Left head</u>
<b>Device Position</b>	<u>Cheek</u>
<b>Band</b>	<u>Bluetooth</u>
<b>Channels</b>	<u>Middle</u>
<b>Signal</b>	<u>Bluetooth (Crest factor: 1.0)</u>
<b>ConvF</b>	<u>2.85</u>

## B. SAR Measurement Results

<b>Frequency (MHz)</b>	2441.000000
<b>Relative permittivity (real part)</b>	40.138912
<b>Relative permittivity (imaginary part)</b>	13.361049
<b>Conductivity (S/m)</b>	1.811907
<b>Variation (%)</b>	2.790000

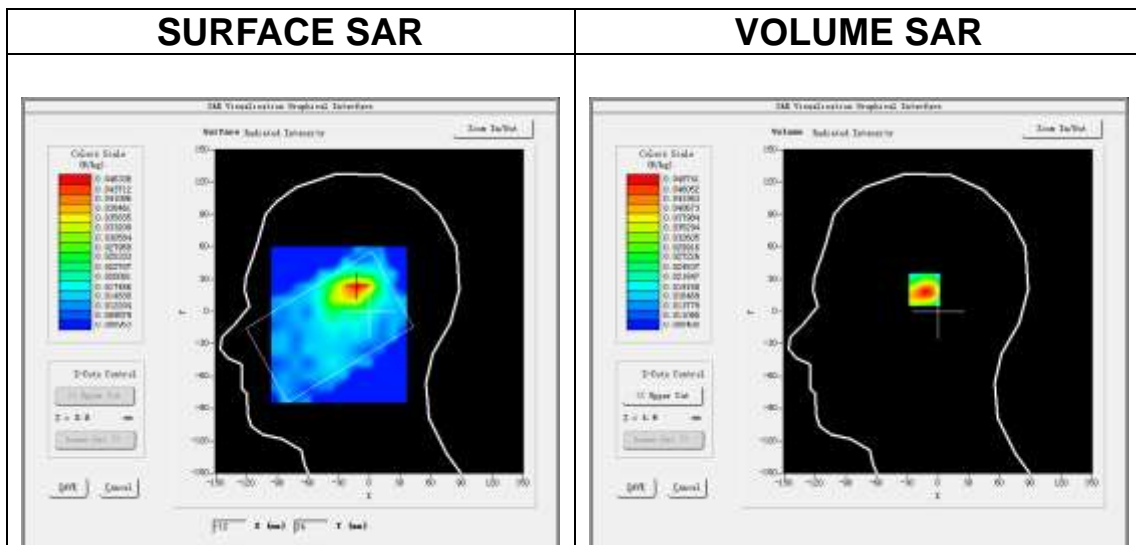

**Maximum location: X=-12.00, Y=22.00**  
**SAR Peak: 0.08 W/kg**

<b>SAR 10g (W/Kg)</b>	0.027830
<b>SAR 1g (W/Kg)</b>	0.045797

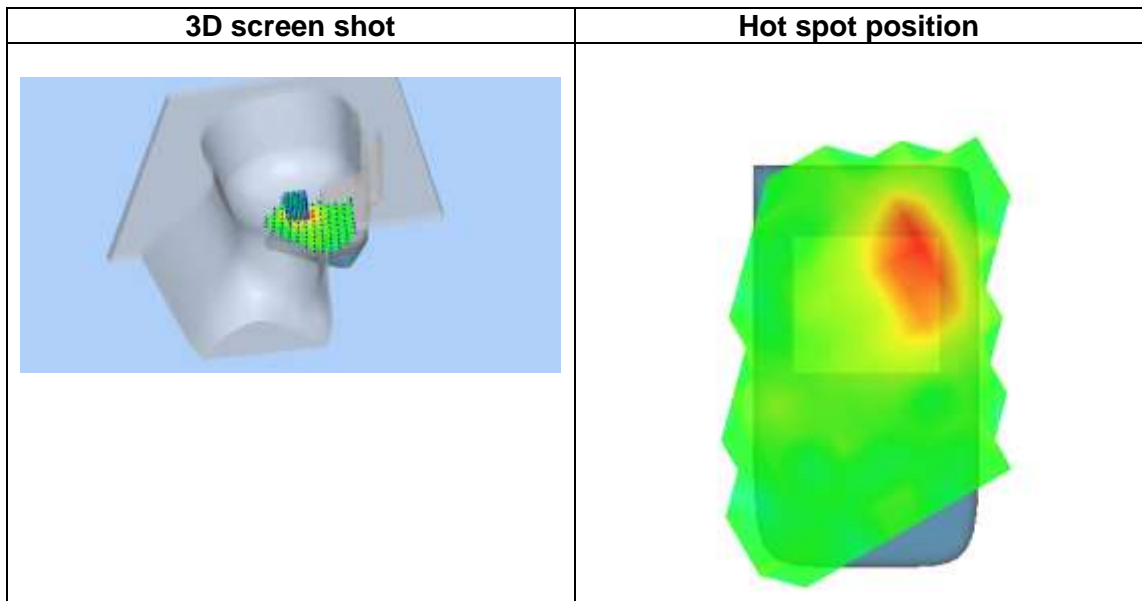
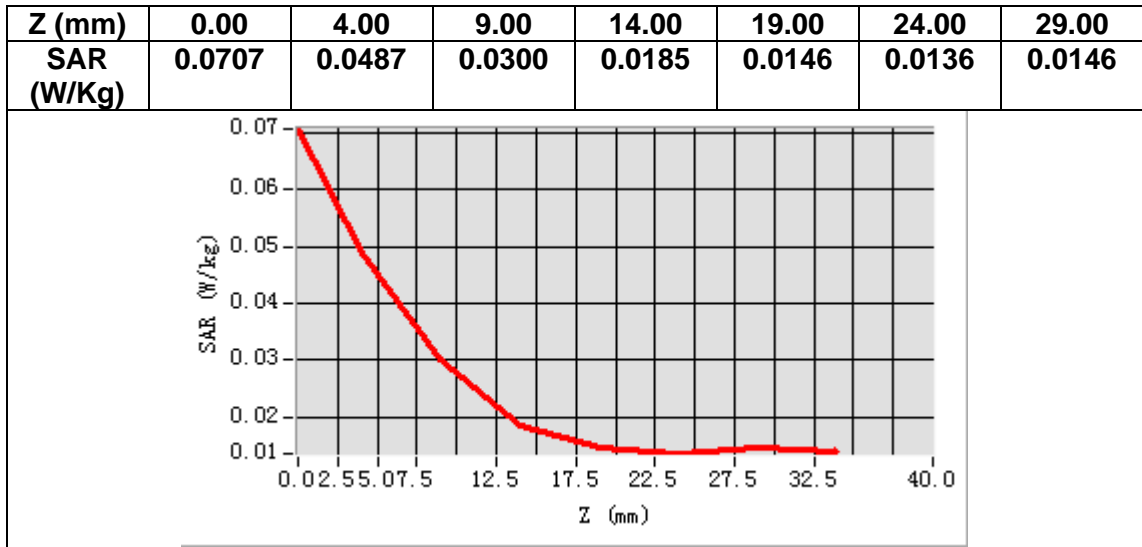



# MEASUREMENT 12

Date of measurement: 16/9/2024

## A. Experimental conditions.

<b>Area Scan</b>	<u>dx=12mm dy=12mm, h= 5.00 mm</u>
<b>ZoomScan</b>	<u>7x7x7, dx=5mm dy=5mm dz=5mm</u>
<b>Phantom</b>	<u>Validation plane</u>
<b>Device Position</b>	<u>Body</u>
<b>Band</b>	<u>Bluetooth</u>
<b>Channels</b>	<u>High</u>
<b>Signal</b>	<u>Bluetooth (Crest factor: 1.0)</u>
<b>ConvF</b>	<u>2.85</u>

## B. SAR Measurement Results

<b>Frequency (MHz)</b>	2480.000000
<b>Relative permittivity (real part)</b>	40.138912
<b>Relative permittivity (imaginary part)</b>	13.361049
<b>Conductivity (S/m)</b>	1.811907
<b>Variation (%)</b>	0.700000

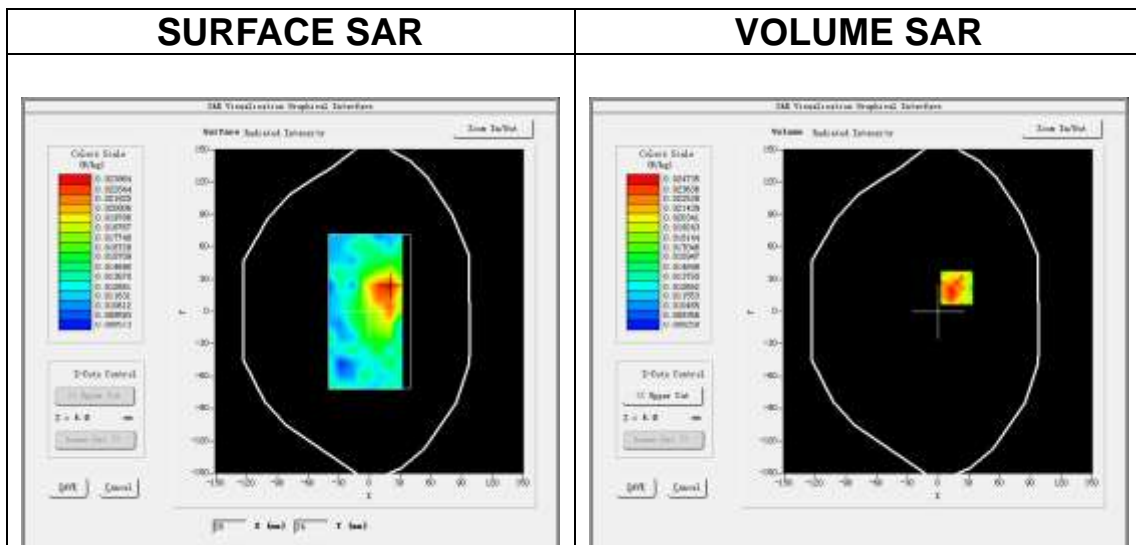

**Maximum location: X=18.00, Y=22.00**  
**SAR Peak: 0.05 W/kg**

<b>SAR 10g (W/Kg)</b>	0.017453
<b>SAR 1g (W/Kg)</b>	0.024736

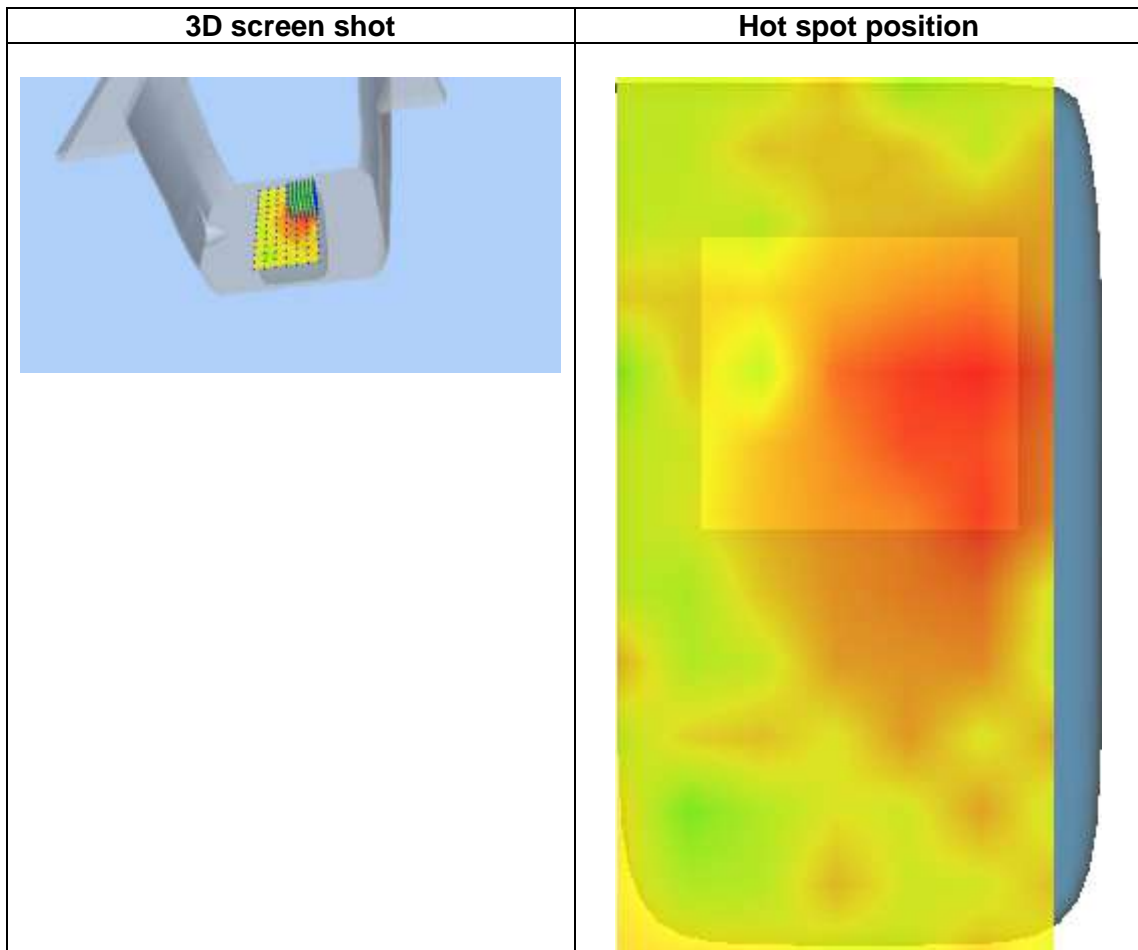
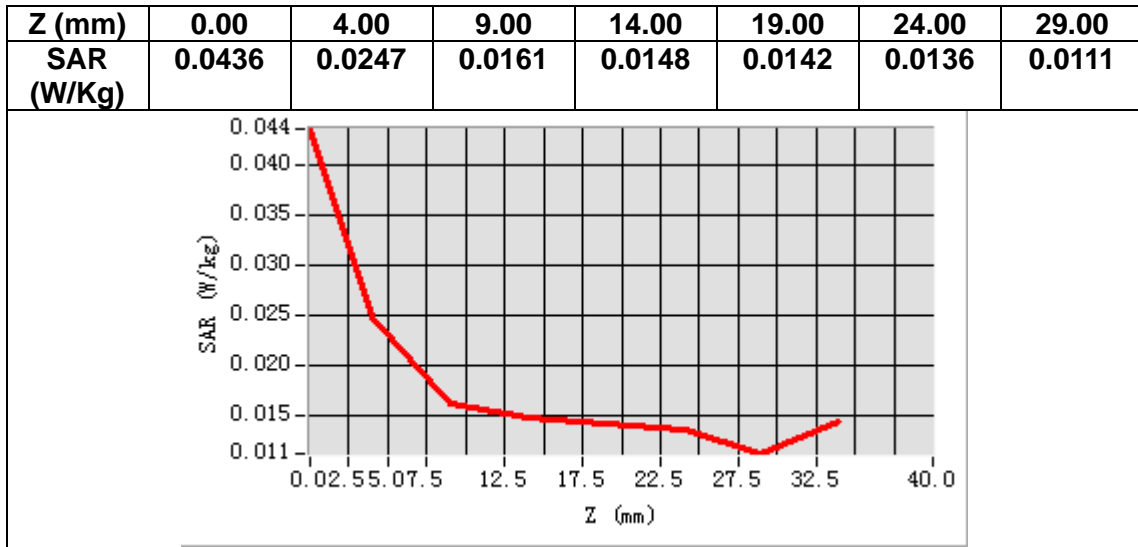

# MEASUREMENT 13

Date of measurement: 5/10/2024

## A. Experimental conditions.

<b>Area Scan</b>	<u>dx=10mm dy=10mm, h= 2.00 mm</u>
<b>ZoomScan</b>	<u>7x7x12,dx=4mm dy=4mm dz=2mm</u>
<b>Phantom</b>	<u>Left head</u>
<b>Device Position</b>	<u>Cheek</u>
<b>Band</b>	<u>IEEE 802.11a U-NII</u>
<b>Channels</b>	<u>High</u>
<b>Signal</b>	<u>IEEE802.11a (Crest factor: 1.0)</u>
<b>ConvF</b>	<u>1.89</u>

## B. SAR Measurement Results

<b>Frequency (MHz)</b>	5240.000000
<b>Relative permittivity (real part)</b>	36.747215
<b>Relative permittivity (imaginary part)</b>	15.759931
<b>Conductivity (S/m)</b>	4.552869
<b>Variation (%)</b>	-2.220000

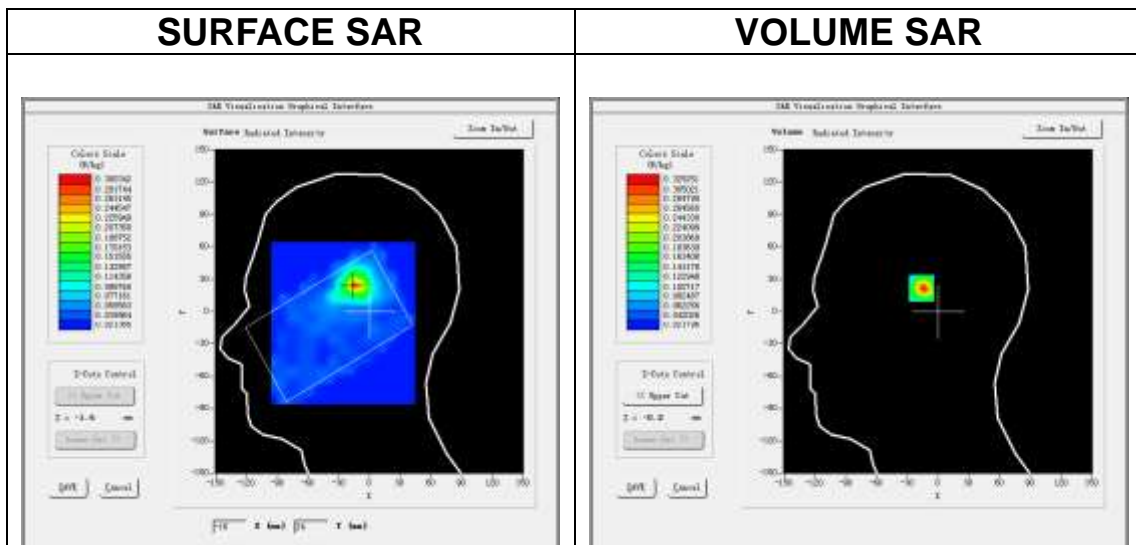

**Maximum location: X=-15.00, Y=25.00**  
**SAR Peak: 0.83 W/kg**

<b>SAR 10g (W/Kg)</b>	0.122191
<b>SAR 1g (W/Kg)</b>	0.307175

<b>Z (m)</b>	<b>0.00</b>	<b>2.00</b>	<b>4.00</b>	<b>6.00</b>	<b>8.00</b>	<b>10.00</b>	<b>12.00</b>	<b>14.00</b>	<b>16.00</b>	<b>18.00</b>	<b>20.00</b>	<b>22.00</b>
<b>SAR (W/Kg)</b>	<b>0.5227</b>	<b>0.3253</b>	<b>0.1865</b>	<b>0.1201</b>	<b>0.0799</b>	<b>0.0590</b>	<b>0.0577</b>	<b>0.0454</b>	<b>0.0425</b>	<b>0.0434</b>	<b>0.0441</b>	<b>0.0224</b>

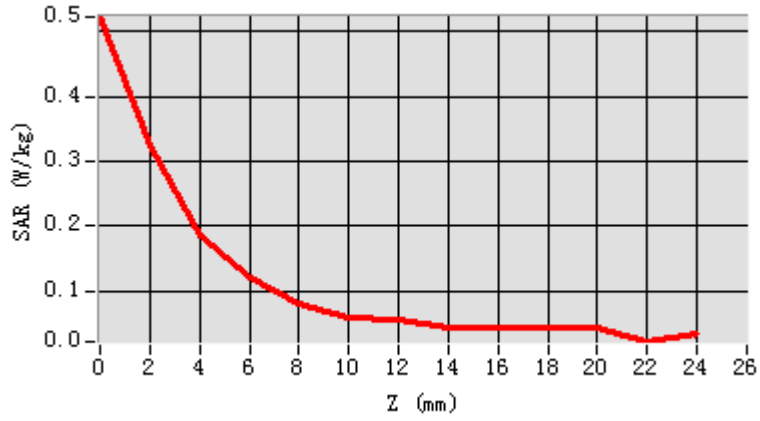

<b>3D screen shot</b>	<b>Hot spot position</b>

# MEASUREMENT 14

Date of measurement: 7/10/2024

## A. Experimental conditions.

<b>Area Scan</b>	<u>dx=10mm dy=10mm, h= 2.00 mm</u>
<b>ZoomScan</b>	<u>7x7x12,dx=4mm dy=4mm dz=2mm</u>
<b>Phantom</b>	<u>Left head</u>
<b>Device Position</b>	<u>Cheek</u>
<b>Band</b>	<u>IEEE 802.11a U-NII</u>
<b>Channels</b>	<u>Middle</u>
<b>Signal</b>	<u>IEEE802.11a (Crest factor: 1.0)</u>
<b>ConvF</b>	<u>1.90</u>

## B. SAR Measurement Results

<b>Frequency (MHz)</b>	5775.000000
<b>Relative permittivity (real part)</b>	35.353451
<b>Relative permittivity (imaginary part)</b>	15.646664
<b>Conductivity (S/m)</b>	5.028664
<b>Variation (%)</b>	-2.850000

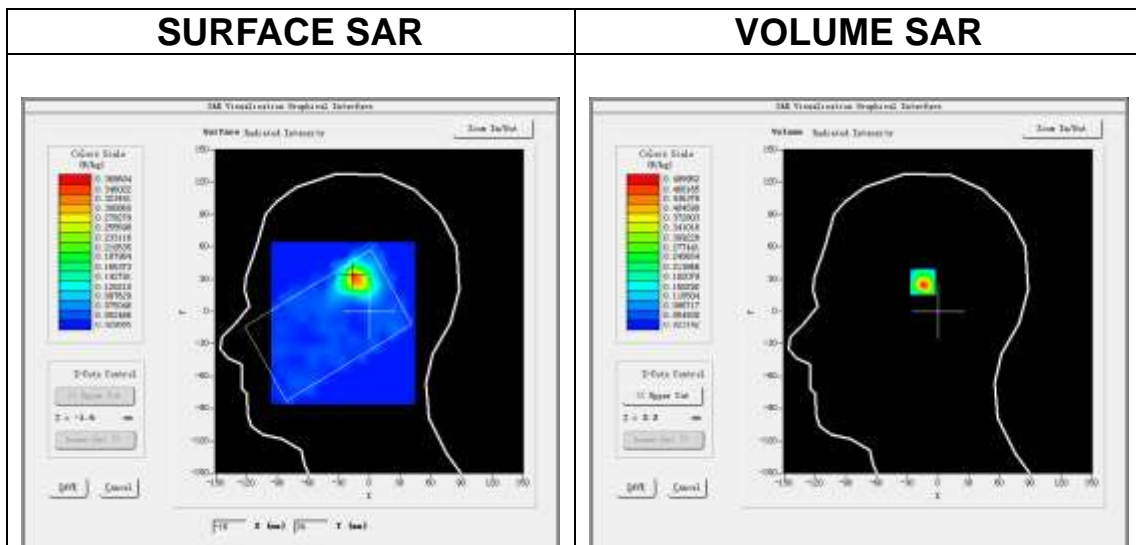

**Maximum location: X=-14.00, Y=32.00**  
**SAR Peak: 1.37 W/kg**

<b>SAR 10g (W/Kg)</b>	0.167328
<b>SAR 1g (W/Kg)</b>	0.469841

<b>Z (m m)</b>	<b>0.00</b>	<b>2.00</b>	<b>4.00</b>	<b>6.00</b>	<b>8.00</b>	<b>10.00</b>	<b>12.00</b>	<b>14.00</b>	<b>16.00</b>	<b>18.00</b>	<b>20.00</b>	<b>22.00</b>
<b>SAR (W/Kg)</b>	<b>0.8650</b>	<b>0.5000</b>	<b>0.1843</b>	<b>0.1367</b>	<b>0.0848</b>	<b>0.0611</b>	<b>0.0534</b>	<b>0.0517</b>	<b>0.0491</b>	<b>0.0387</b>	<b>0.0383</b>	<b>0.0409</b>

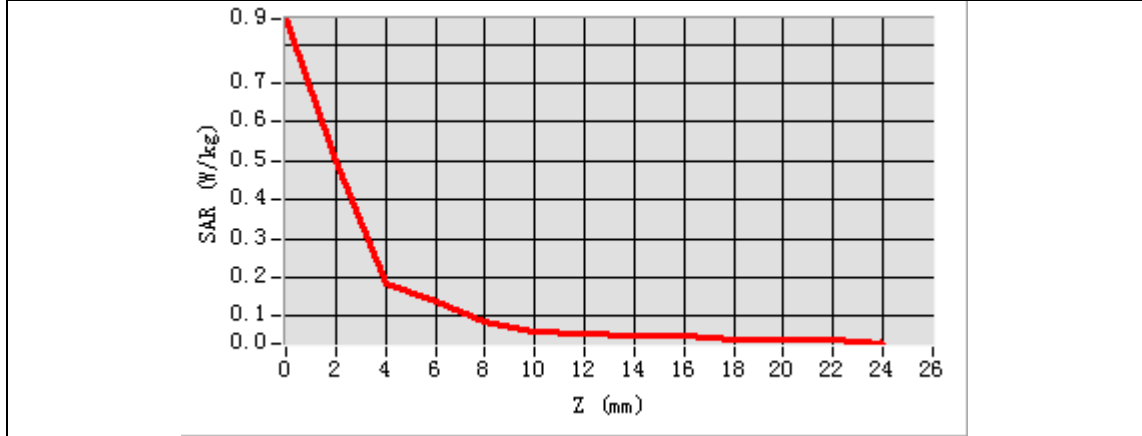

<b>3D screen shot</b>	<b>Hot spot position</b>

# MEASUREMENT 15

Date of measurement: 5/10/2024

## A. Experimental conditions.

<b>Area Scan</b>	<u>dx=10mm dy=10mm, h= 2.00 mm</u>
<b>ZoomScan</b>	<u>7x7x12,dx=4mm dy=4mm dz=2mm</u>
<b>Phantom</b>	<u>Validation plane</u>
<b>Device Position</b>	<u>Body</u>
<b>Band</b>	<u>IEEE 802.11a U-NII</u>
<b>Channels</b>	<u>High</u>
<b>Signal</b>	<u>IEEE802.11a (Crest factor: 1.0)</u>
<b>ConvF</b>	<u>1.89</u>

## B. SAR Measurement Results

<b>Frequency (MHz)</b>	5240.000000
<b>Relative permittivity (real part)</b>	36.747215
<b>Relative permittivity (imaginary part)</b>	15.759931
<b>Conductivity (S/m)</b>	4.552869
<b>Variation (%)</b>	-0.610000

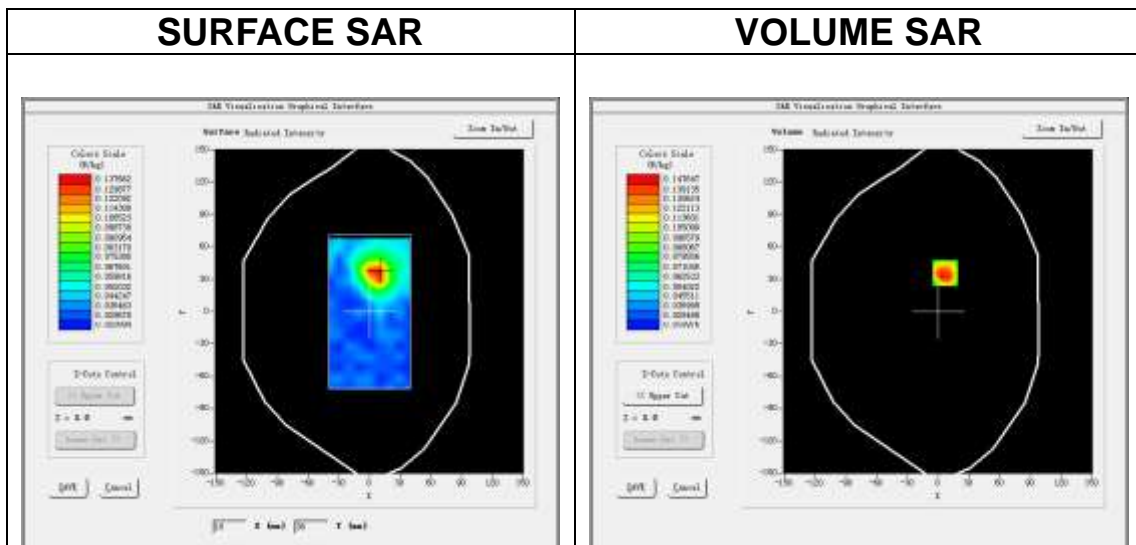

**Maximum location: X=7.00, Y=36.00**  
**SAR Peak: 0.26 W/kg**

<b>SAR 10g (W/Kg)</b>	0.032749
<b>SAR 1g (W/Kg)</b>	0.064571

Z (m)	0.00	2.00	4.00	6.00	8.00	10.00	12.00	14.00	16.00	18.00	20.00	22.00
SAR (W/Kg)	0.2283	0.1476	0.0807	0.0630	0.0535	0.0457	0.0366	0.0487	0.0359	0.0235	0.0369	0.0301

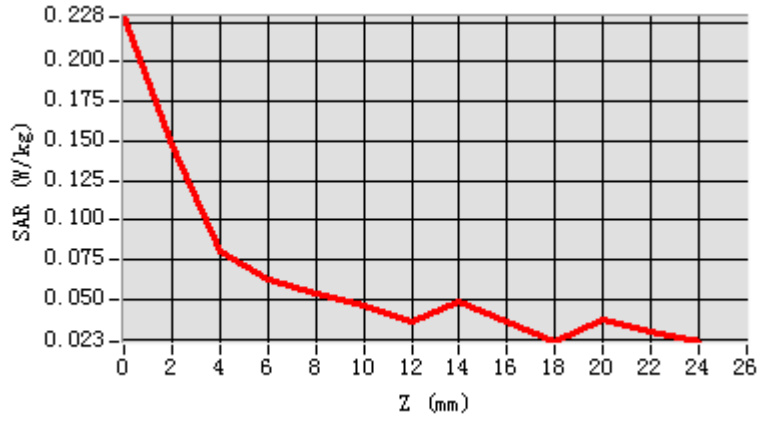

<b>3D screen shot</b>	<b>Hot spot position</b>



# MEASUREMENT 16

Date of measurement: 7/10/2024

## A. Experimental conditions.

<b>Area Scan</b>	<u>dx=10mm dy=10mm, h= 2.00 mm</u>
<b>ZoomScan</b>	<u>7x7x12,dx=4mm dy=4mm dz=2mm</u>
<b>Phantom</b>	<u>Validation plane</u>
<b>Device Position</b>	<u>Body</u>
<b>Band</b>	<u>IEEE 802.11a U-NII</u>
<b>Channels</b>	<u>Middle</u>
<b>Signal</b>	<u>IEEE802.11a (Crest factor: 1.0)</u>
<b>ConvF</b>	<u>1.90</u>

## B. SAR Measurement Results

<b>Frequency (MHz)</b>	5775.000000
<b>Relative permittivity (real part)</b>	35.353451
<b>Relative permittivity (imaginary part)</b>	15.646664
<b>Conductivity (S/m)</b>	5.028664
<b>Variation (%)</b>	3.849998

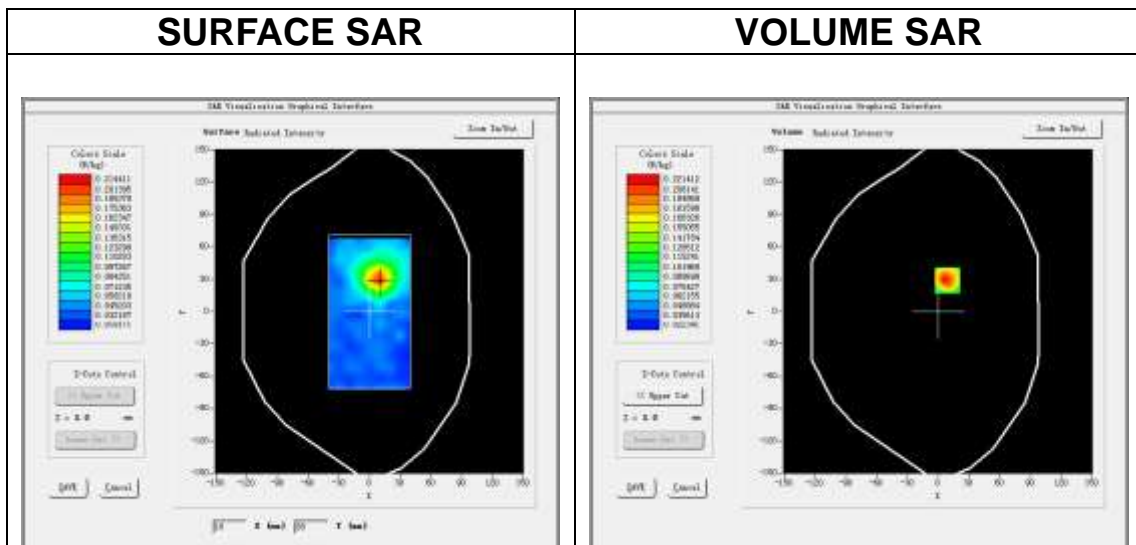

**Maximum location: X=9.00, Y=29.00**

**SAR Peak: 0.37 W/kg**

<b>SAR 10g (W/Kg)</b>	0.076885
<b>SAR 1g (W/Kg)</b>	0.112316

<b>Z (m)</b>	<b>0.00</b>	<b>2.00</b>	<b>4.00</b>	<b>6.00</b>	<b>8.00</b>	<b>10.00</b>	<b>12.00</b>	<b>14.00</b>	<b>16.00</b>	<b>18.00</b>	<b>20.00</b>	<b>22.00</b>
<b>SAR (W/Kg)</b>	<b>0.3381</b>	<b>0.2214</b>	<b>0.1219</b>	<b>0.0816</b>	<b>0.0585</b>	<b>0.0489</b>	<b>0.0302</b>	<b>0.0252</b>	<b>0.0250</b>	<b>0.0357</b>	<b>0.0304</b>	<b>0.0403</b>

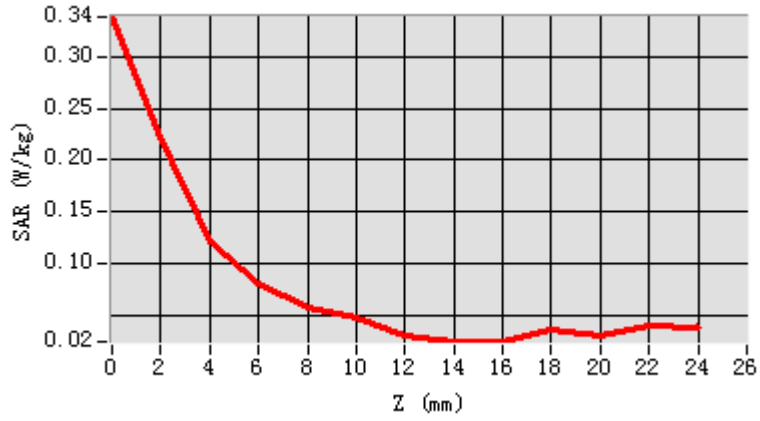

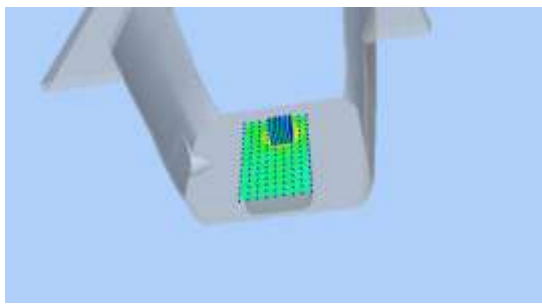
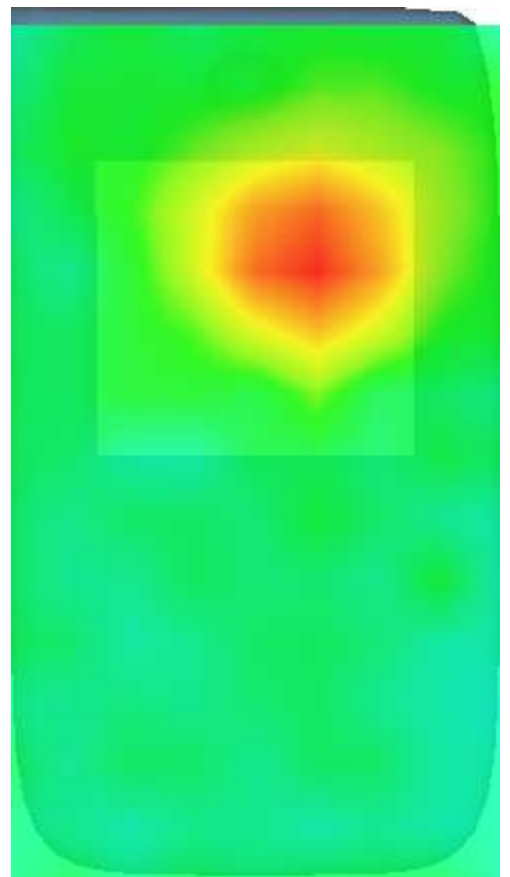
3D screen shot	Hot spot position
	

# MEASUREMENT 17

Date of measurement: 16/9/2024

## A. Experimental conditions.

<b>Area Scan</b>	<u>dx=12mm dy=12mm, h= 5.00 mm</u>
<b>ZoomScan</b>	<u>7x7x7,dx=5mm dy=5mm dz=5mm</u>
<b>Phantom</b>	<u>Left head</u>
<b>Device Position</b>	<u>Cheek</u>
<b>Band</b>	<u>IEEE 802.11b ISM</u>
<b>Channels</b>	<u>High</u>
<b>Signal</b>	<u>IEEE802.11b (Crest factor: 1.0)</u>
<b>ConvF</b>	<u>2.85</u>

## B. SAR Measurement Results

<b>Frequency (MHz)</b>	2462.000000
<b>Relative permittivity (real part)</b>	40.163013
<b>Relative permittivity (imaginary part)</b>	13.349949
<b>Conductivity (S/m)</b>	1.807435
<b>Variation (%)</b>	-1.020000

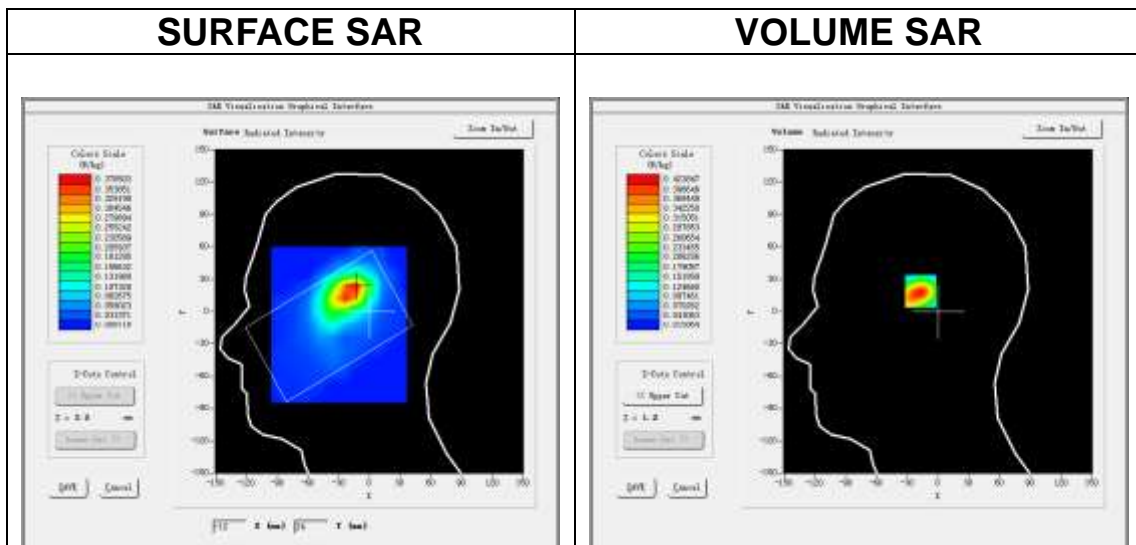

**Maximum location: X=-16.00, Y=21.00**  
**SAR Peak: 0.72 W/kg**

<b>SAR 10g (W/Kg)</b>	0.202144
<b>SAR 1g (W/Kg)</b>	0.401224

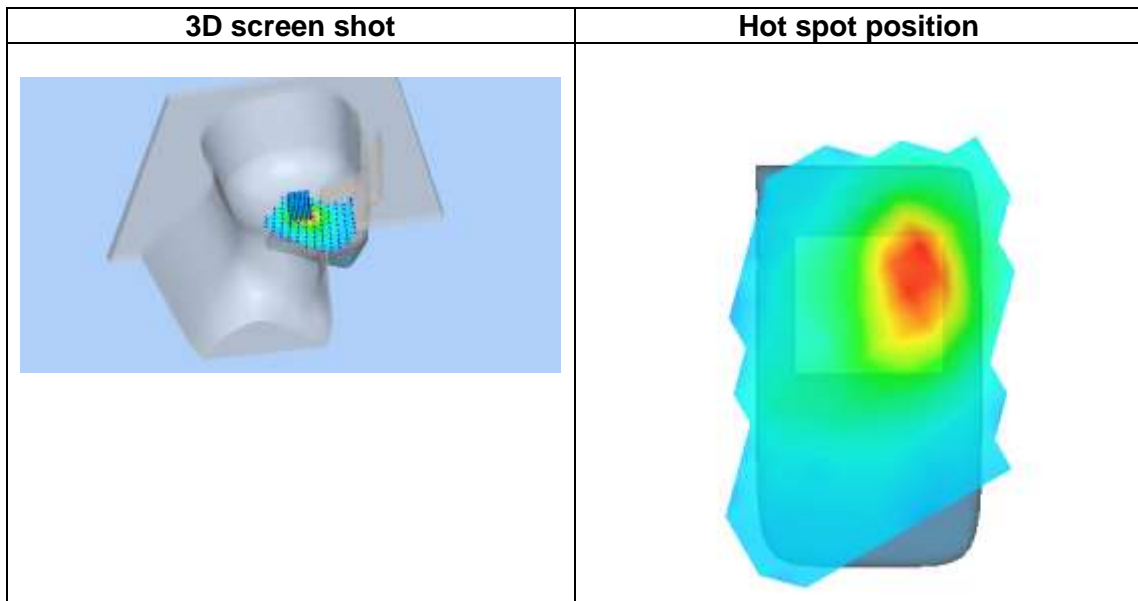
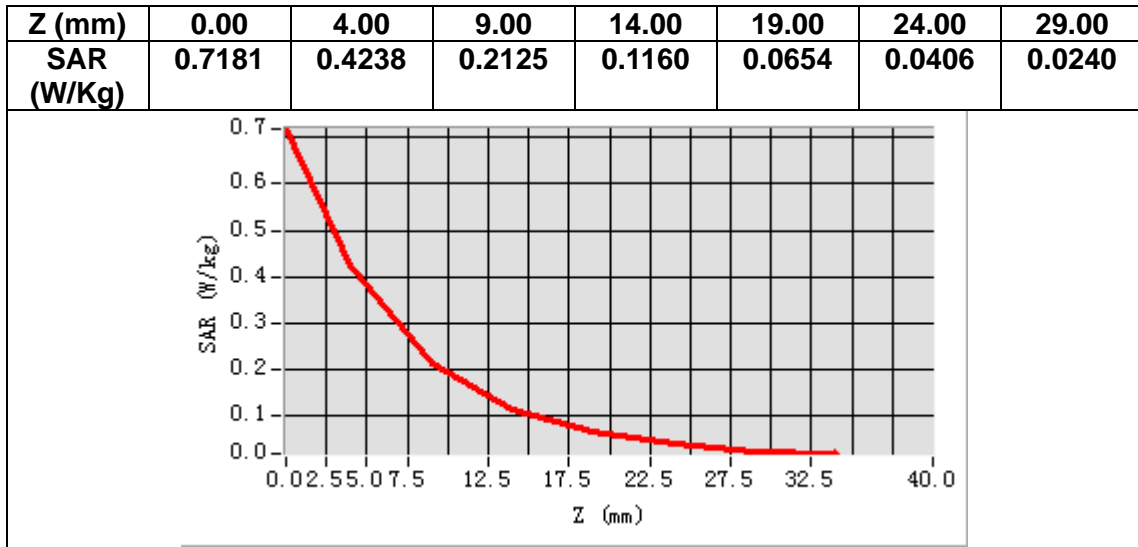

# MEASUREMENT 18

Date of measurement: 16/9/2024

## A. Experimental conditions.

<b>Area Scan</b>	<u>dx=12mm dy=12mm, h= 5.00 mm</u>
<b>ZoomScan</b>	<u>7x7x7,dx=5mm dy=5mm dz=5mm</u>
<b>Phantom</b>	<u>Validation plane</u>
<b>Device Position</b>	<u>Body</u>
<b>Band</b>	<u>IEEE 802.11b ISM</u>
<b>Channels</b>	<u>High</u>
<b>Signal</b>	<u>IEEE802.11b (Crest factor: 1.0)</u>
<b>ConvF</b>	<u>2.85</u>

## B. SAR Measurement Results

<b>Frequency (MHz)</b>	2462.000000
<b>Relative permittivity (real part)</b>	40.163013
<b>Relative permittivity (imaginary part)</b>	13.349949
<b>Conductivity (S/m)</b>	1.807435
<b>Variation (%)</b>	-0.180000

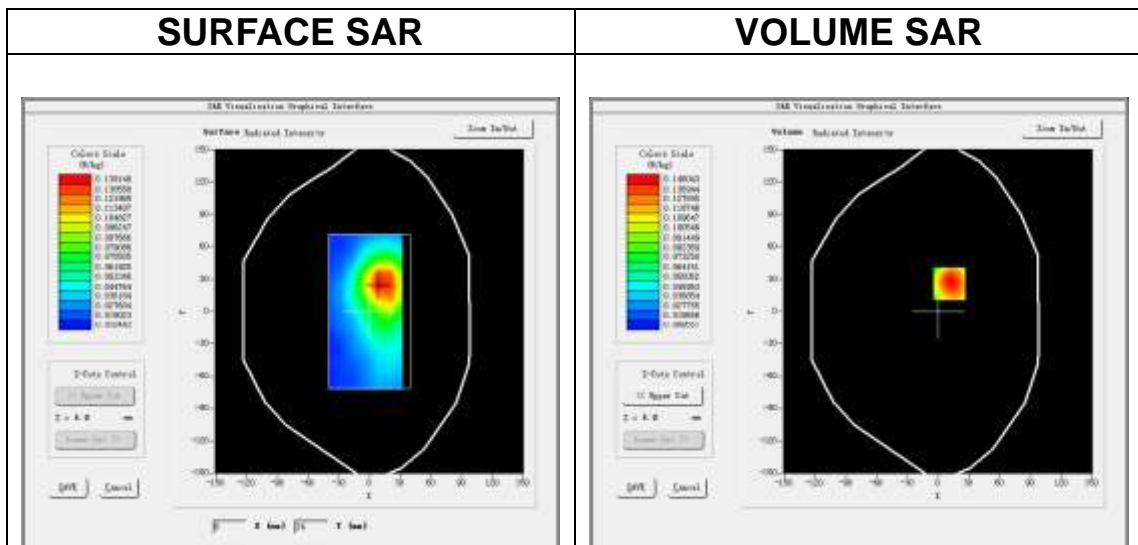

**Maximum location: X=11.00, Y=26.00**  
**SAR Peak: 0.24 W/kg**

<b>SAR 10g (W/Kg)</b>	0.080175
<b>SAR 1g (W/Kg)</b>	0.141115

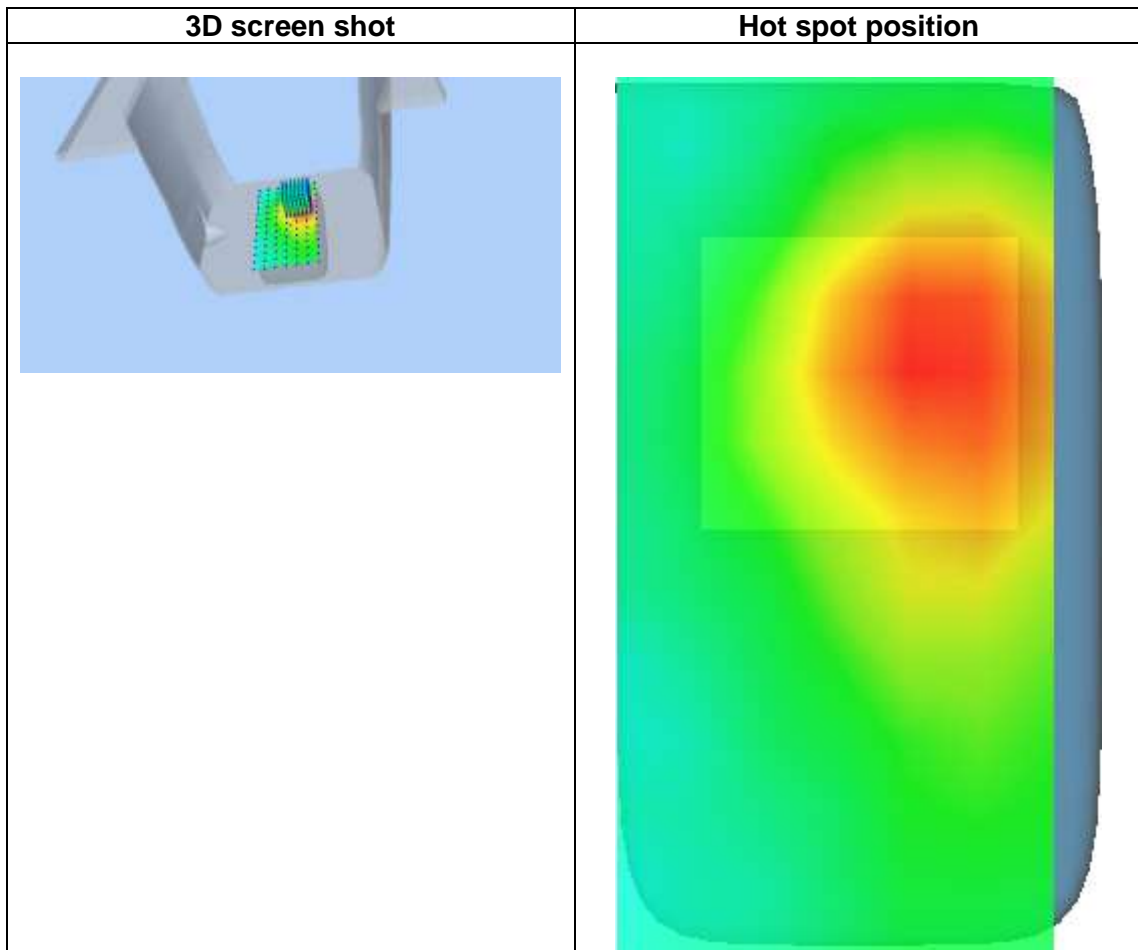
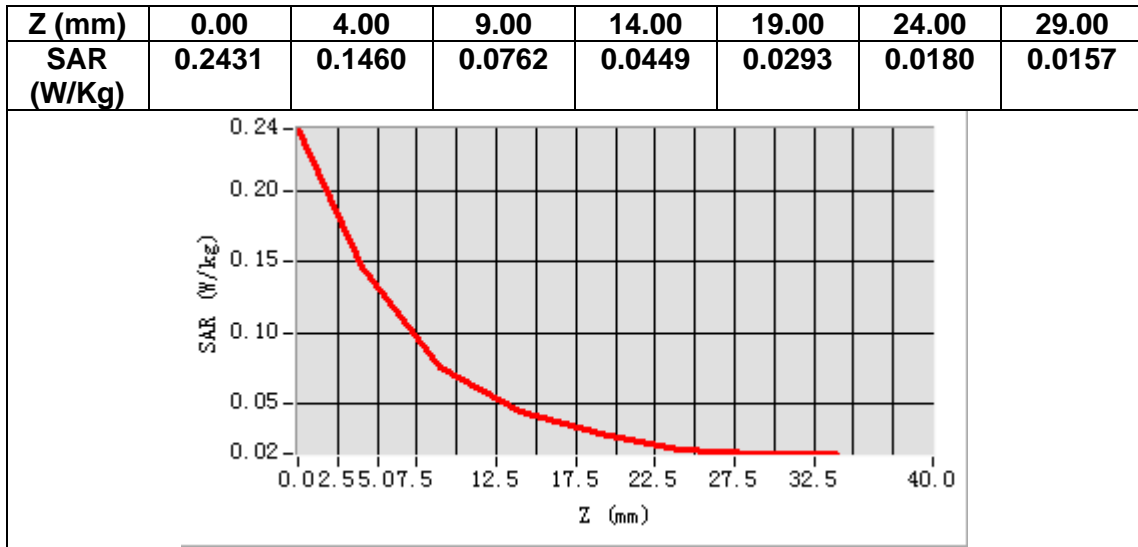

# MEASUREMENT 19

Date of measurement: 12/10/2024

## A. Experimental conditions.

<b>Area Scan</b>	<u>dx=15mm dy=15mm, h= 5.00 mm</u>
<b>ZoomScan</b>	<u>5x5x7,dx=8mm dy=8mm dz=5mm</u>
<b>Phantom</b>	<u>Left head</u>
<b>Device Position</b>	<u>Cheek</u>
<b>Band</b>	<u>LTE band 2</u>
<b>Channels</b>	<u>Middle</u>
<b>Signal</b>	<u>LTE (Crest factor: 1.0)</u>
<b>ConvF</b>	<u>2.57</u>

## B. SAR Measurement Results

<b>Frequency (MHz)</b>	1880.000000
<b>Relative permittivity (real part)</b>	38.526512
<b>Relative permittivity (imaginary part)</b>	13.733387
<b>Conductivity (S/m)</b>	1.434376
<b>Variation (%)</b>	4.760000

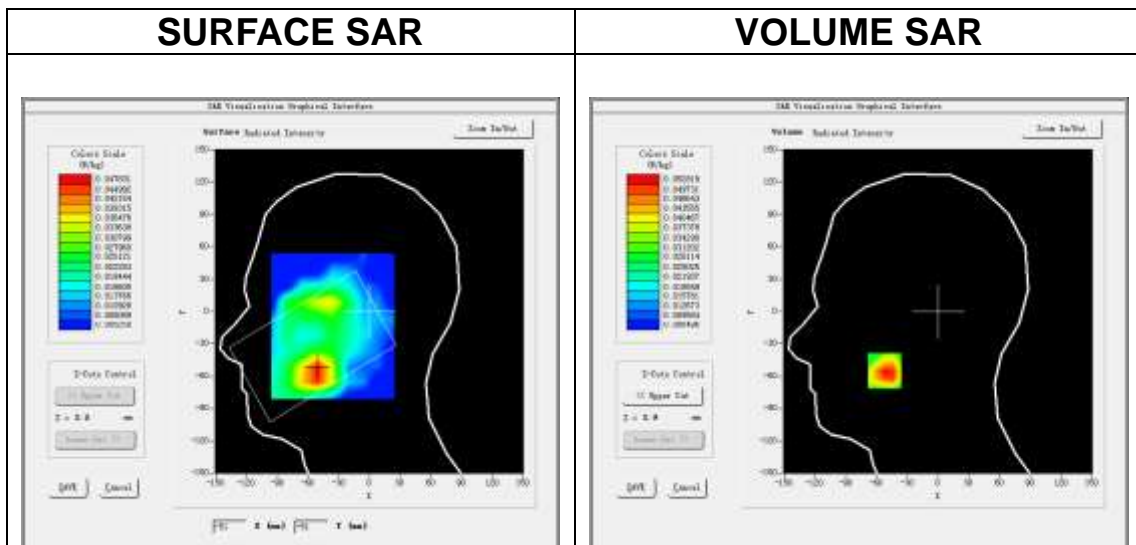

**Maximum location: X=-52.00, Y=-55.00**  
**SAR Peak: 0.07 W/kg**

<b>SAR 10g (W/Kg)</b>	0.033998
<b>SAR 1g (W/Kg)</b>	0.052591

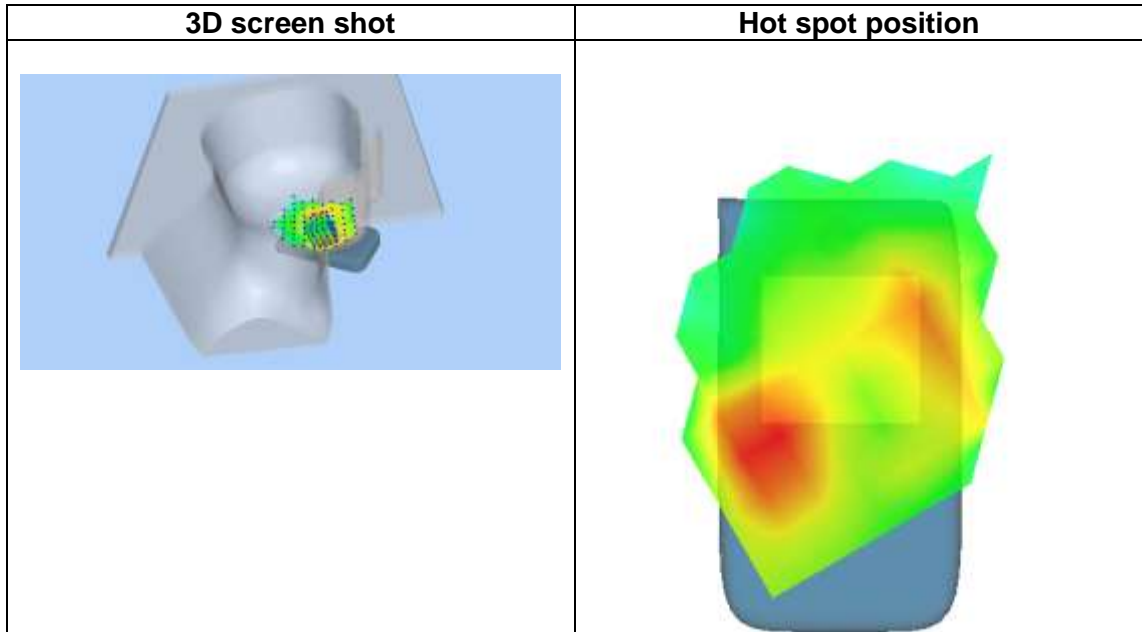
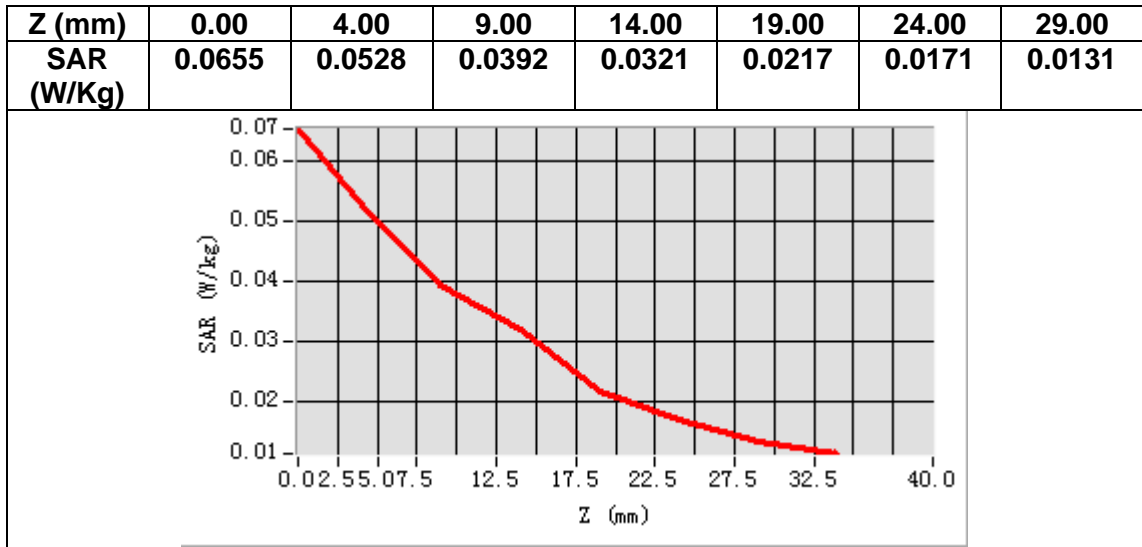



# MEASUREMENT 20

Date of measurement: 12/10/2024

## A. Experimental conditions.

<b>Area Scan</b>	<u>dx=15mm dy=15mm, h= 5.00 mm</u>
<b>ZoomScan</b>	<u>5x5x7,dx=8mm dy=8mm dz=5mm</u>
<b>Phantom</b>	<u>Validation plane</u>
<b>Device Position</b>	<u>Body</u>
<b>Band</b>	<u>LTE band 2</u>
<b>Channels</b>	<u>Middle</u>
<b>Signal</b>	<u>LTE (Crest factor: 1.0)</u>
<b>ConvF</b>	<u>2.57</u>

## B. SAR Measurement Results

<b>Frequency (MHz)</b>	1880.000000
<b>Relative permittivity (real part)</b>	38.526512
<b>Relative permittivity (imaginary part)</b>	13.733387
<b>Conductivity (S/m)</b>	1.434376
<b>Variation (%)</b>	-2.460000

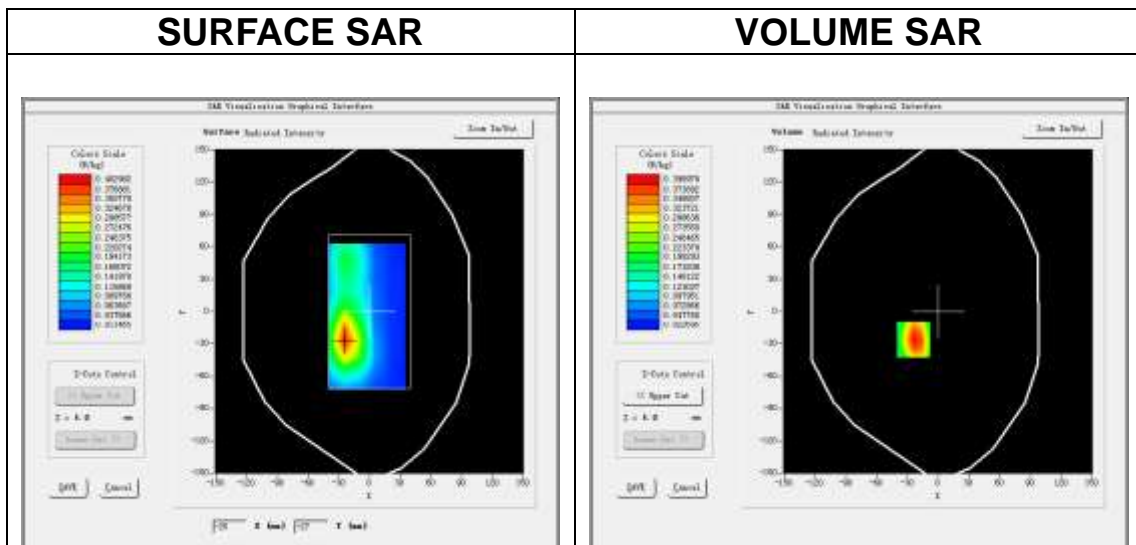

**Maximum location: X=-24.00, Y=-26.00**  
**SAR Peak: 0.57 W/kg**

<b>SAR 10g (W/Kg)</b>	0.236821
<b>SAR 1g (W/Kg)</b>	0.393038

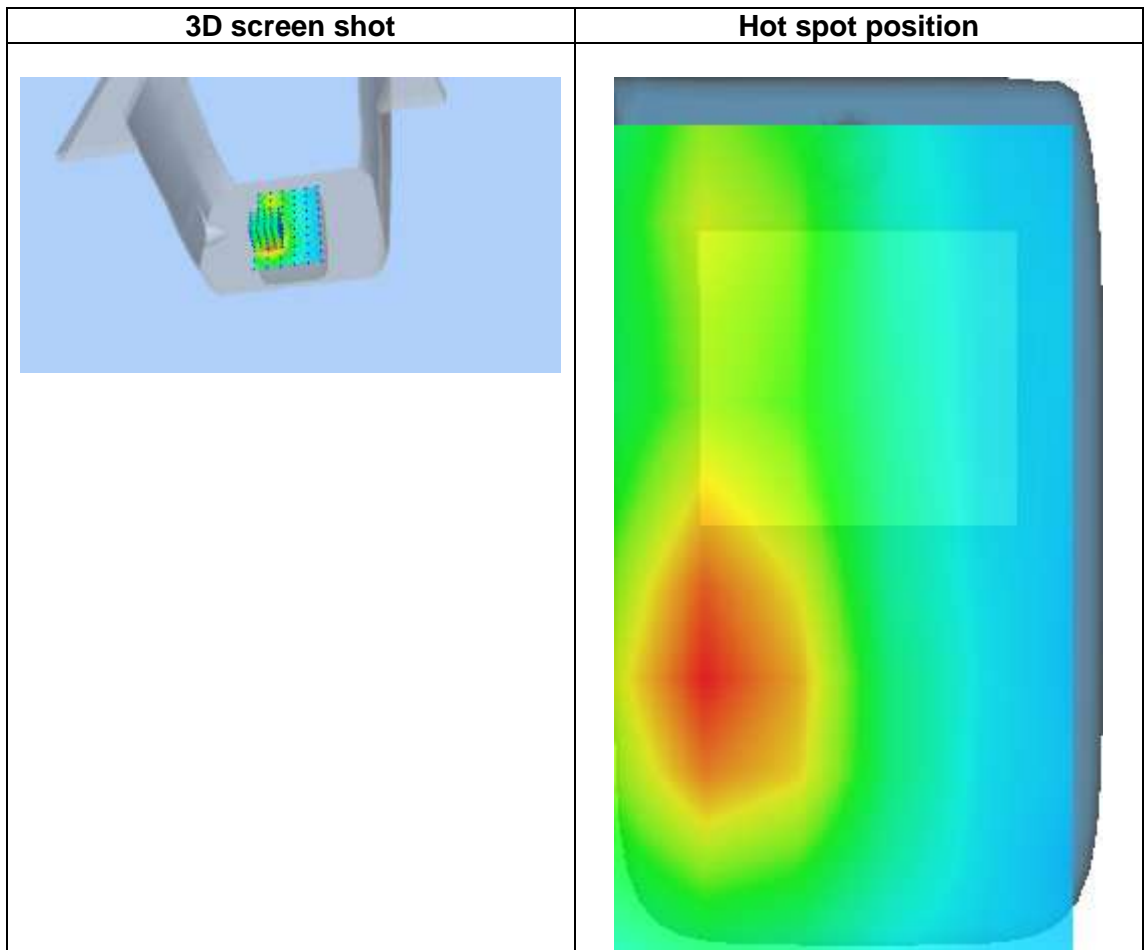
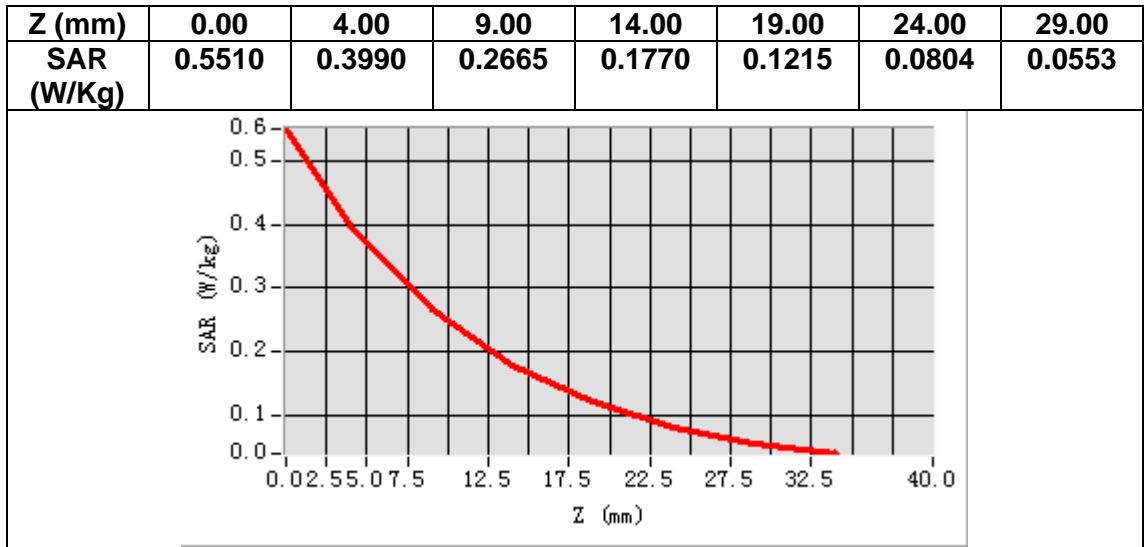

# MEASUREMENT 21

Date of measurement: 13/9/2024

## A. Experimental conditions.

<b>Area Scan</b>	<u>dx=15mm dy=15mm, h= 5.00 mm</u>
<b>ZoomScan</b>	<u>5x5x7,dx=8mm dy=8mm dz=5mm</u>
<b>Phantom</b>	<u>Left head</u>
<b>Device Position</b>	<u>Cheek</u>
<b>Band</b>	<u>LTE band 4</u>
<b>Channels</b>	<u>Middle</u>
<b>Signal</b>	<u>LTE (Crest factor: 1.0)</u>
<b>ConvF</b>	<u>2.45</u>

## B. SAR Measurement Results

<b>Frequency (MHz)</b>	1732.500000
<b>Relative permittivity (real part)</b>	39.788006
<b>Relative permittivity (imaginary part)</b>	13.679339
<b>Conductivity (S/m)</b>	1.316636
<b>Variation (%)</b>	4.860000

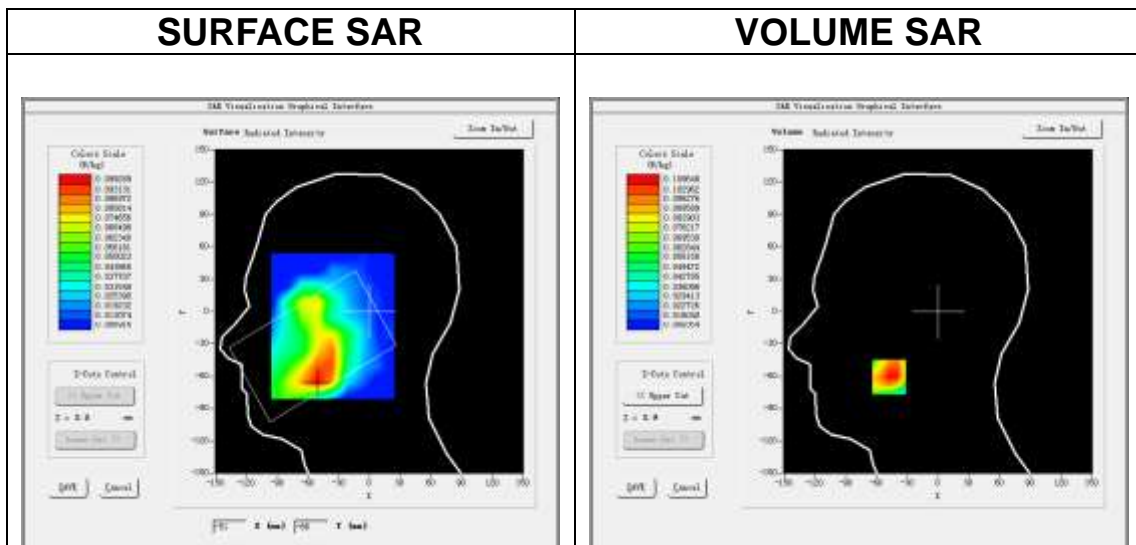

**Maximum location: X=-48.00, Y=-61.00**  
**SAR Peak: 0.16 W/kg**

<b>SAR 10g (W/Kg)</b>	0.071451
<b>SAR 1g (W/Kg)</b>	0.108001

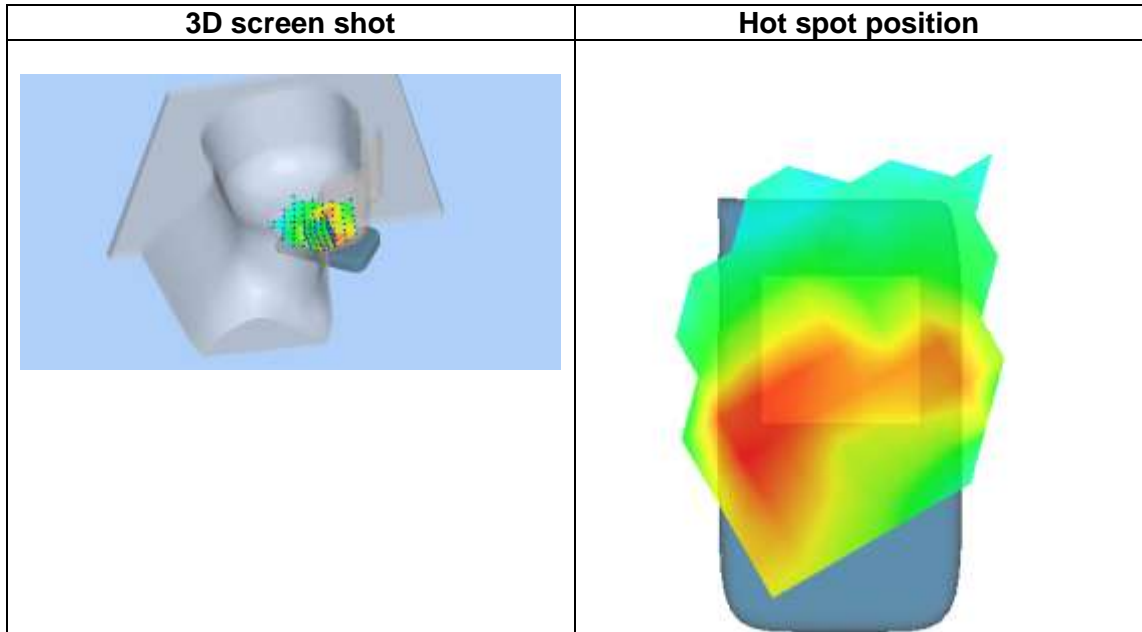
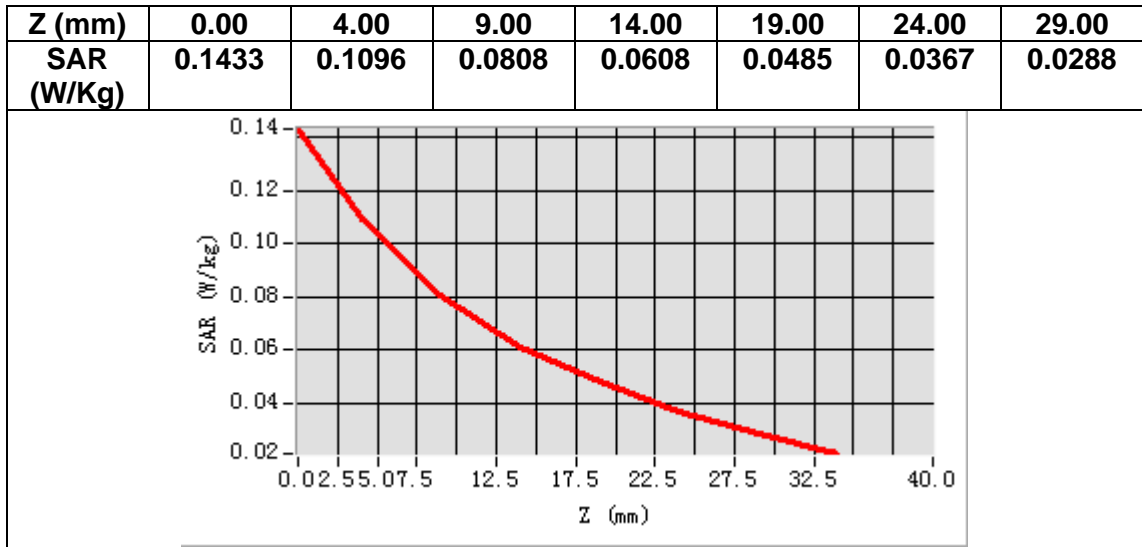

# MEASUREMENT 22

Date of measurement: 13/9/2024

## A. Experimental conditions.

<b>Area Scan</b>	<u>dx=15mm dy=15mm, h= 5.00 mm</u>
<b>ZoomScan</b>	<u>5x5x7,dx=8mm dy=8mm dz=5mm</u>
<b>Phantom</b>	<u>Validation plane</u>
<b>Device Position</b>	<u>Body</u>
<b>Band</b>	<u>LTE band 4</u>
<b>Channels</b>	<u>Middle</u>
<b>Signal</b>	<u>LTE (Crest factor: 1.0)</u>
<b>ConvF</b>	<u>2.45</u>

## B. SAR Measurement Results

<b>Frequency (MHz)</b>	1732.500000
<b>Relative permittivity (real part)</b>	39.788006
<b>Relative permittivity (imaginary part)</b>	13.679339
<b>Conductivity (S/m)</b>	1.316636
<b>Variation (%)</b>	-0.220000

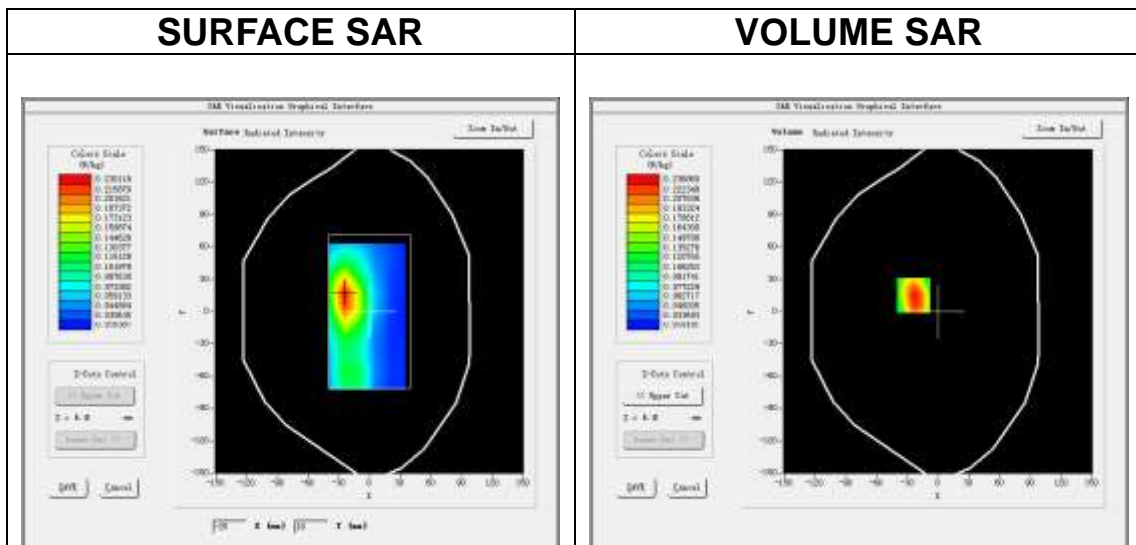

**Maximum location: X=-24.00, Y=15.00**  
**SAR Peak: 0.34 W/kg**

<b>SAR 10g (W/Kg)</b>	0.137002
<b>SAR 1g (W/Kg)</b>	0.226814

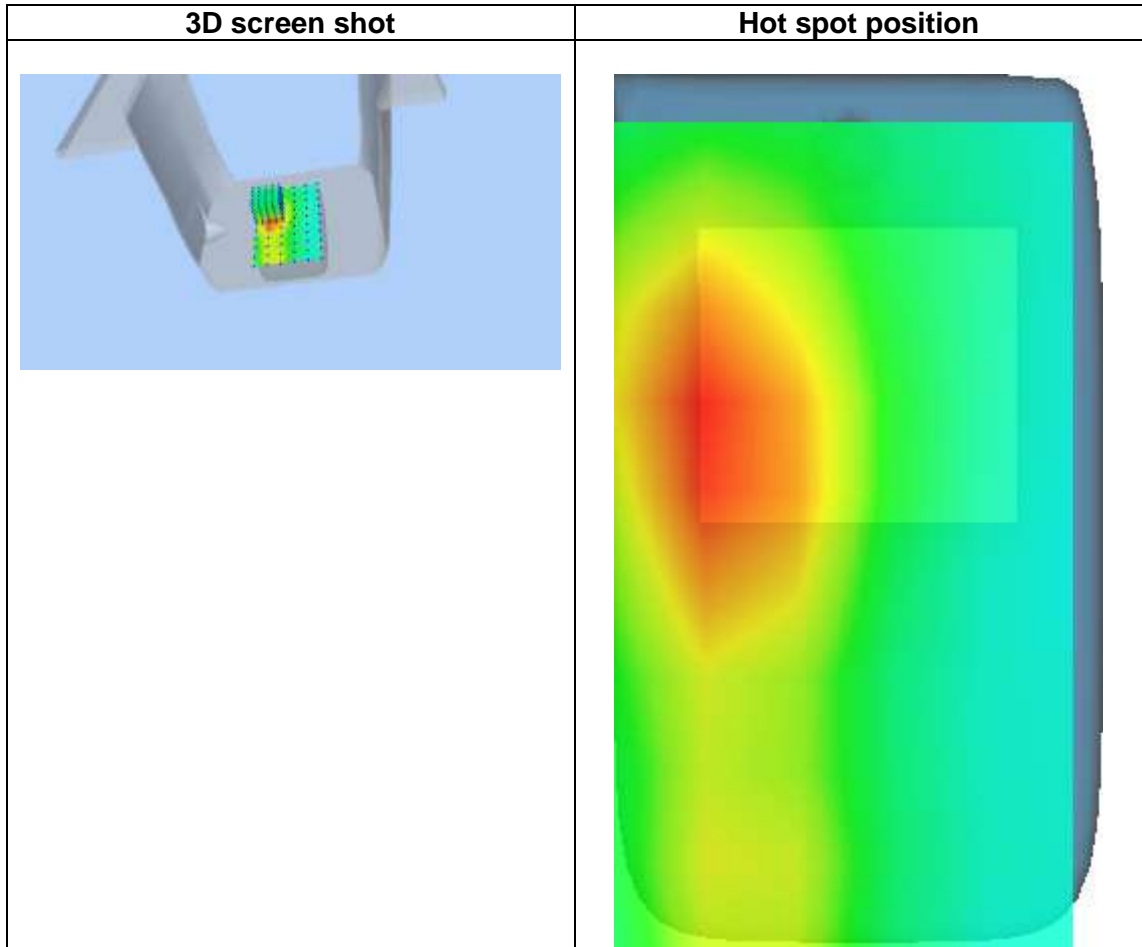
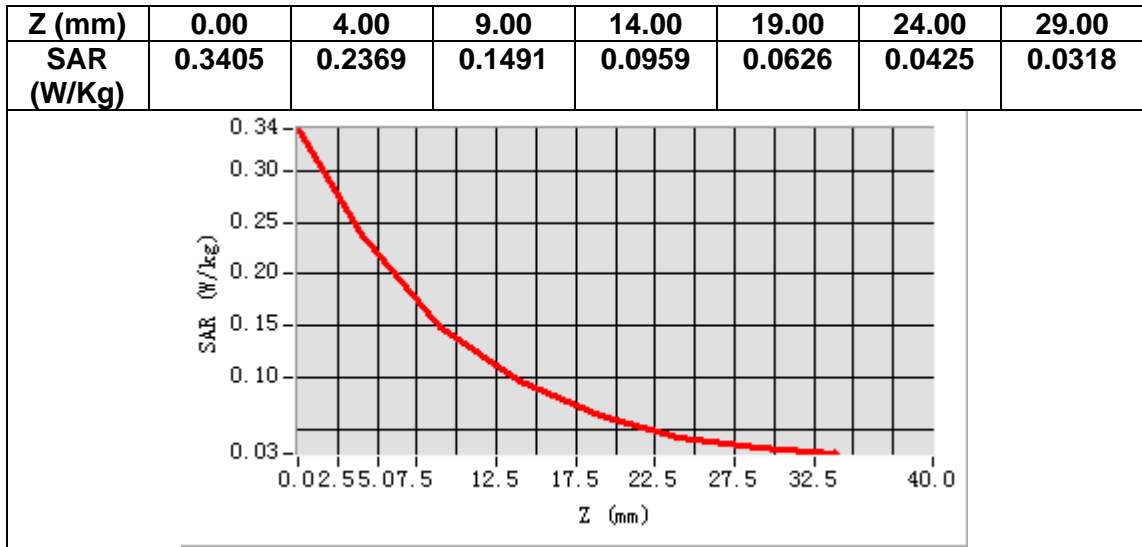

# MEASUREMENT 23

Date of measurement: 10/10/2024

## A. Experimental conditions.

<b>Area Scan</b>	<u>dx=15mm dy=15mm, h= 5.00 mm</u>
<b>ZoomScan</b>	<u>5x5x7,dx=8mm dy=8mm dz=5mm</u>
<b>Phantom</b>	<u>Left head</u>
<b>Device Position</b>	<u>Cheek</u>
<b>Band</b>	<u>LTE band 5</u>
<b>Channels</b>	<u>Middle</u>
<b>Signal</b>	<u>LTE (Crest factor: 1.0)</u>
<b>ConvF</b>	<u>2.34</u>

## B. SAR Measurement Results

<b>Frequency (MHz)</b>	836.500000
<b>Relative permittivity (real part)</b>	42.008339
<b>Relative permittivity (imaginary part)</b>	19.847189
<b>Conductivity (S/m)</b>	0.922343
<b>Variation (%)</b>	4.370000

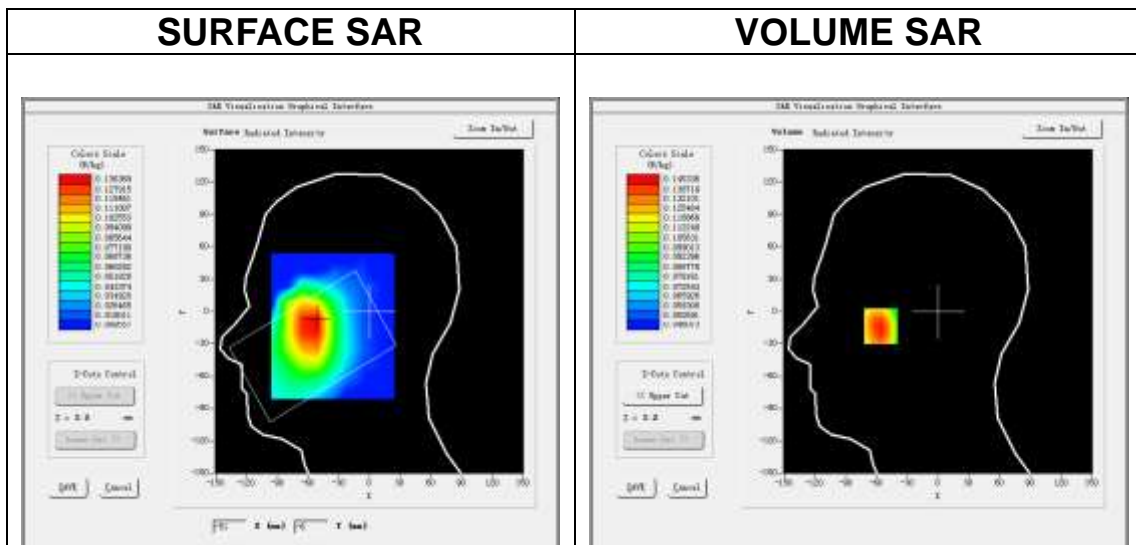

**Maximum location: X=-56.00, Y=-11.00**  
**SAR Peak: 0.14 W/kg**

<b>SAR 10g (W/Kg)</b>	0.132080
<b>SAR 1g (W/Kg)</b>	0.145120

Z (mm)	0.00	4.00	9.00	14.00	19.00	24.00	29.00
SAR (W/Kg)	3.6500	0.1453	0.1397	0.1244	0.1063	0.0924	0.0872

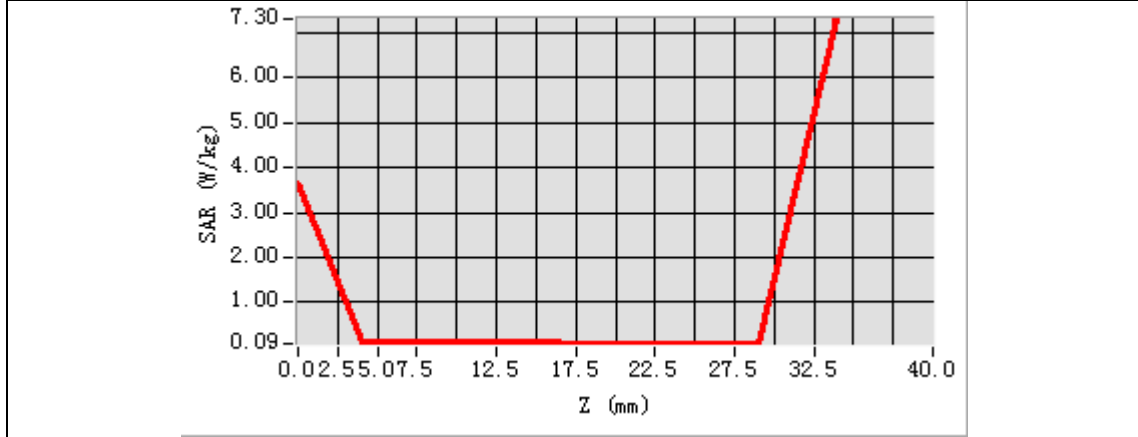

3D screen shot	Hot spot position



# MEASUREMENT 24

Date of measurement: 10/10/2024

## A. Experimental conditions.

<b>Area Scan</b>	<u>dx=15mm dy=15mm, h= 5.00 mm</u>
<b>ZoomScan</b>	<u>5x5x7,dx=8mm dy=8mm dz=5mm</u>
<b>Phantom</b>	<u>Validation plane</u>
<b>Device Position</b>	<u>Body</u>
<b>Band</b>	<u>LTE band 5</u>
<b>Channels</b>	<u>Middle</u>
<b>Signal</b>	<u>LTE (Crest factor: 1.0)</u>
<b>ConvF</b>	<u>2.34</u>

## B. SAR Measurement Results

<b>Frequency (MHz)</b>	836.500000
<b>Relative permittivity (real part)</b>	42.008339
<b>Relative permittivity (imaginary part)</b>	19.847189
<b>Conductivity (S/m)</b>	0.922343
<b>Variation (%)</b>	-0.590000

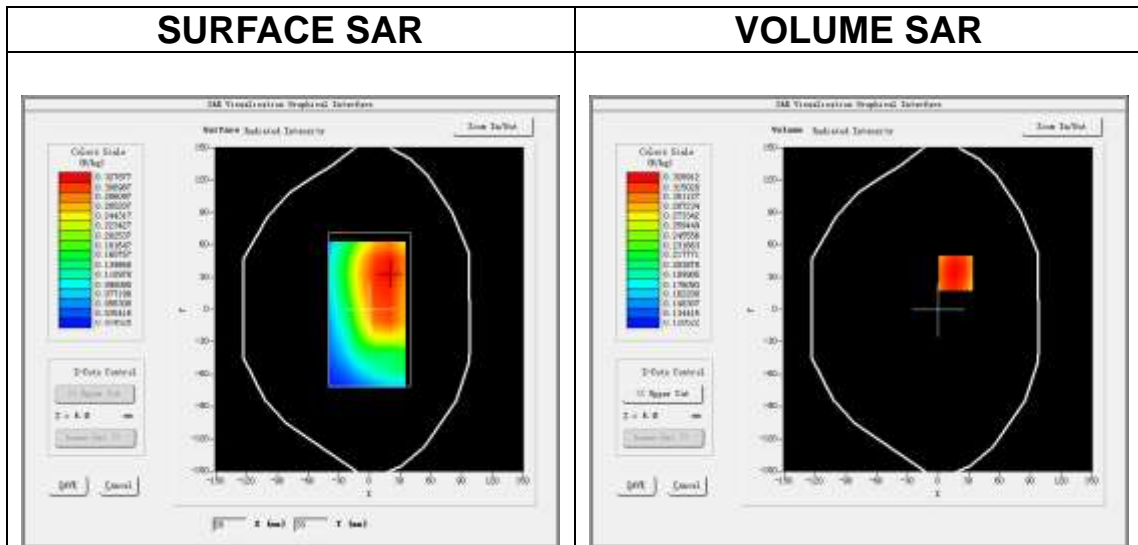

**Maximum location: X=17.00, Y=34.00**  
**SAR Peak: 0.37 W/kg**

<b>SAR 10g (W/Kg)</b>	0.288199
<b>SAR 1g (W/Kg)</b>	0.332027

Z (mm)	0.00	4.00	9.00	14.00	19.00	24.00	29.00
SAR (W/Kg)	0.3645	0.3289	0.2983	0.2743	0.2485	0.2185	0.1904

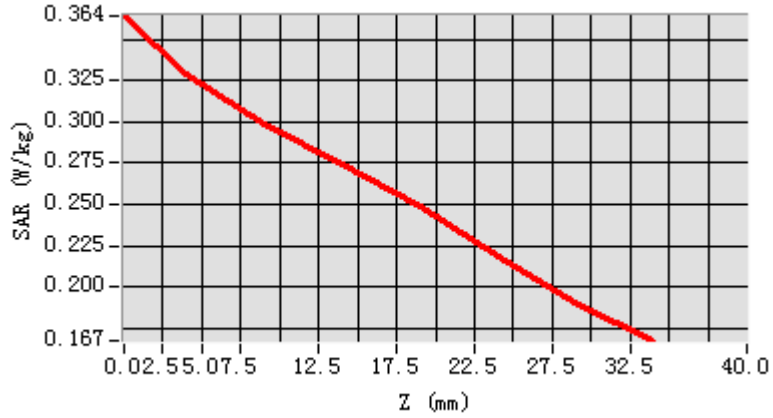

**3D screen shot**

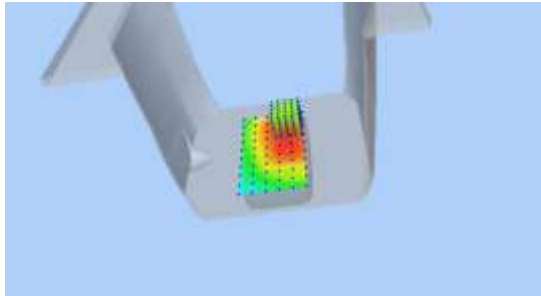

**Hot spot position**

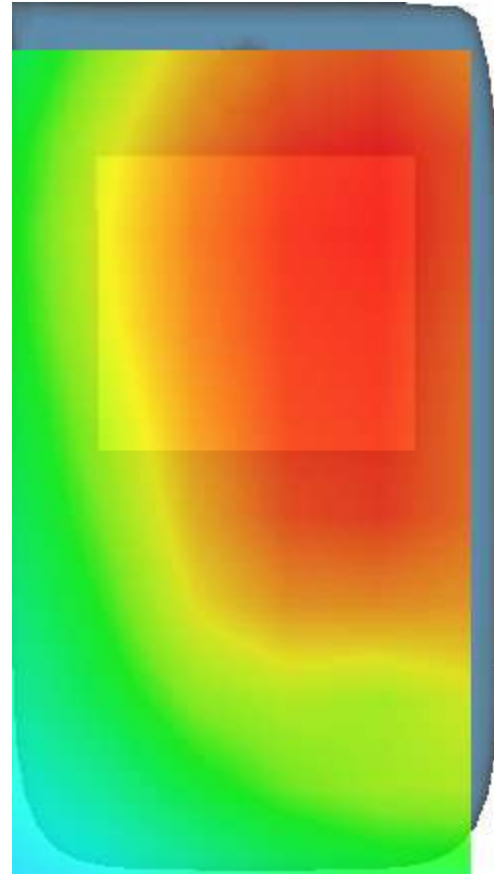

# MEASUREMENT 25

Date of measurement: 13/10/2024

## A. Experimental conditions.

<b>Area Scan</b>	<u>dx=12mm dy=12mm, h= 5.00 mm</u>
<b>ZoomScan</b>	<u>7x7x7,dx=5mm dy=5mm dz=5mm</u>
<b>Phantom</b>	<u>Left head</u>
<b>Device Position</b>	<u>Cheek</u>
<b>Band</b>	<u>LTE band 7</u>
<b>Channels</b>	<u>Middle</u>
<b>Signal</b>	<u>LTE (Crest factor: 1.0)</u>
<b>ConvF</b>	<u>2.51</u>

## B. SAR Measurement Results

<b>Frequency (MHz)</b>	2535.000000
<b>Relative permittivity (real part)</b>	39.285744
<b>Relative permittivity (imaginary part)</b>	13.916988
<b>Conductivity (S/m)</b>	1.959976
<b>Variation (%)</b>	3.500000

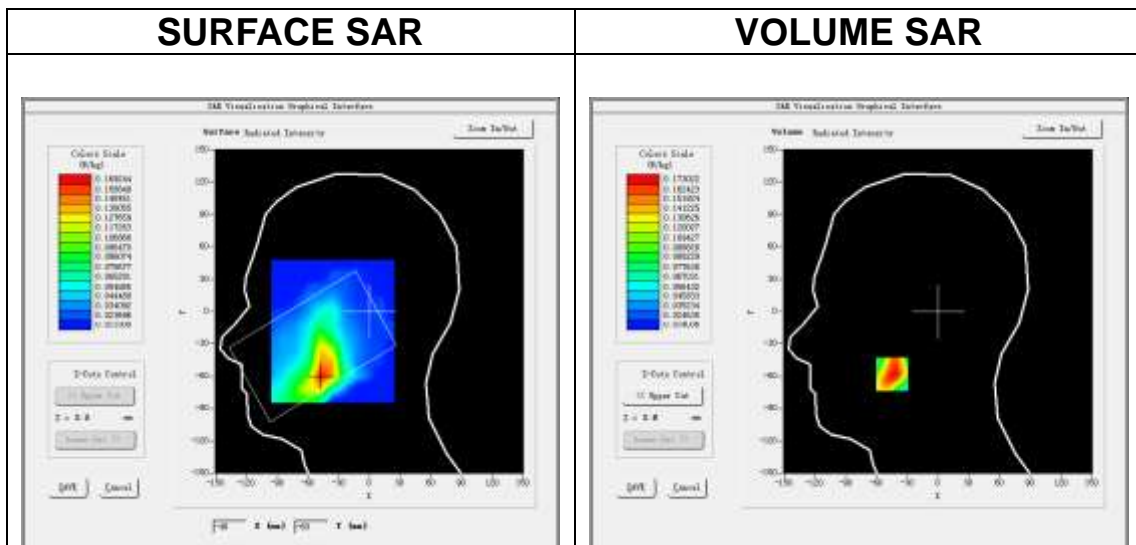

**Maximum location: X=-45.00, Y=-58.00**  
**SAR Peak: 0.26 W/kg**

<b>SAR 10g (W/Kg)</b>	0.095682
<b>SAR 1g (W/Kg)</b>	0.167396

Z (mm)	0.00	4.00	9.00	14.00	19.00	24.00	29.00
SAR (W/Kg)	0.2602	0.1730	0.1053	0.0650	0.0478	0.0317	0.0267

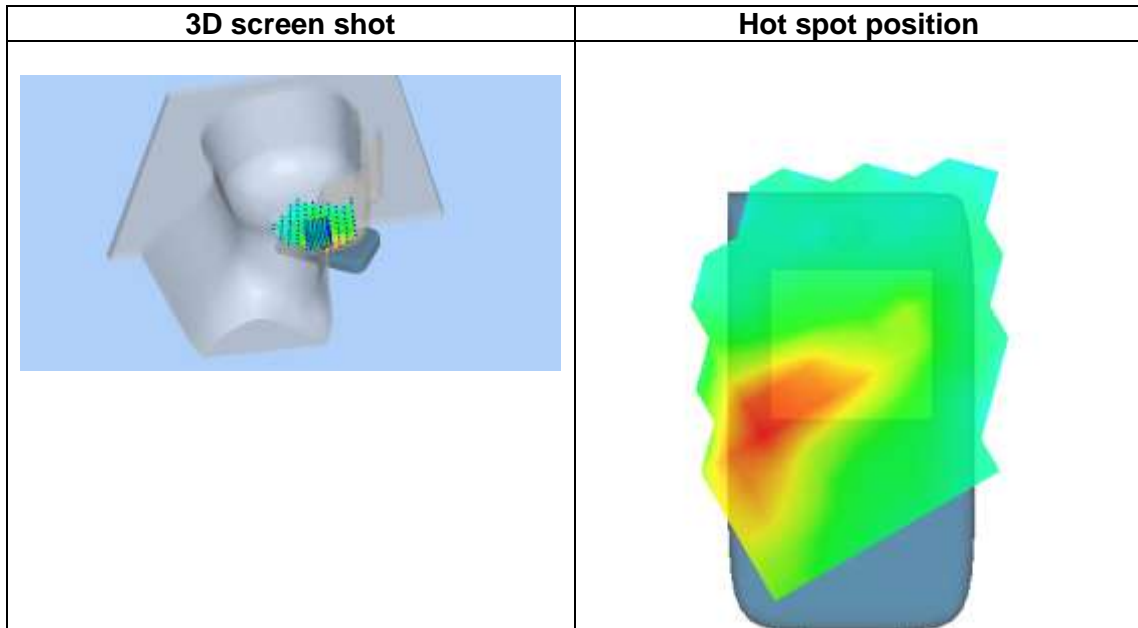
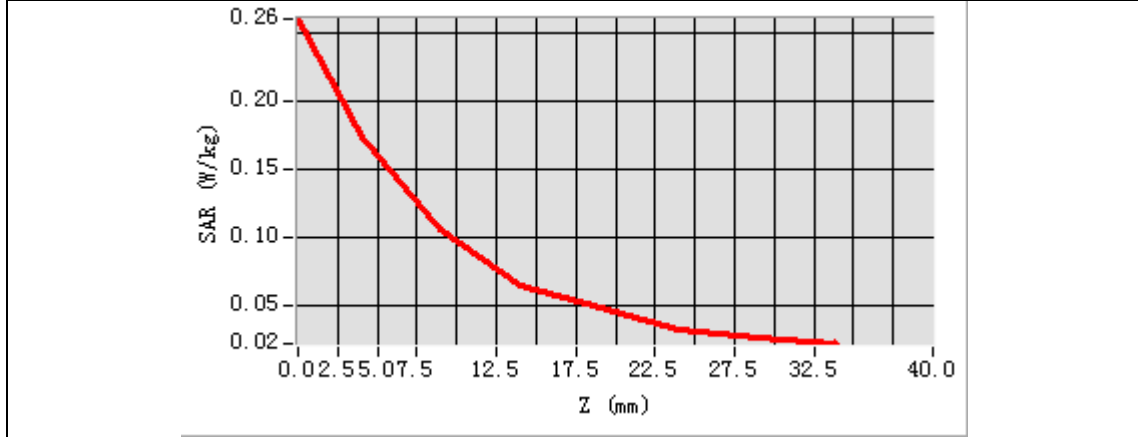

# MEASUREMENT 26

Date of measurement: 13/10/2024

## A. Experimental conditions.

<b>Area Scan</b>	<u>dx=12mm dy=12mm, h= 5.00 mm</u>
<b>ZoomScan</b>	<u>7x7x7,dx=5mm dy=5mm dz=5mm</u>
<b>Phantom</b>	<u>Validation plane</u>
<b>Device Position</b>	<u>Body</u>
<b>Band</b>	<u>LTE band 7</u>
<b>Channels</b>	<u>Middle</u>
<b>Signal</b>	<u>LTE (Crest factor: 1.0)</u>
<b>ConvF</b>	<u>2.51</u>

## B. SAR Measurement Results

<b>Frequency (MHz)</b>	2535.000000
<b>Relative permittivity (real part)</b>	39.285744
<b>Relative permittivity (imaginary part)</b>	13.916988
<b>Conductivity (S/m)</b>	1.959976
<b>Variation (%)</b>	-0.330000

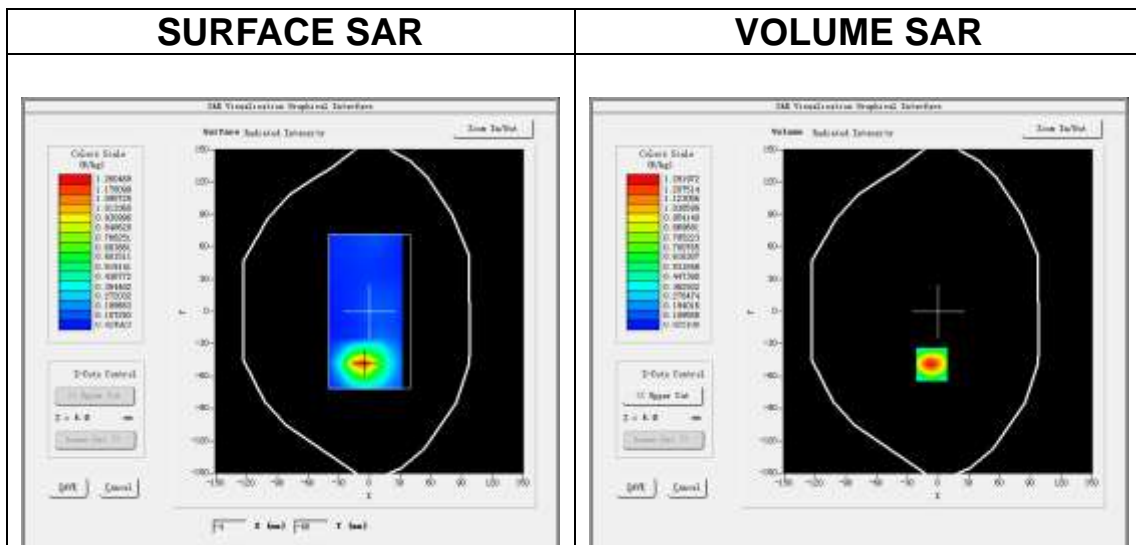

**Maximum location: X=-6.00, Y=-49.00**  
**SAR Peak: 2.07 W/kg**

<b>SAR 10g (W/Kg)</b>	0.597586
<b>SAR 1g (W/Kg)</b>	1.215516

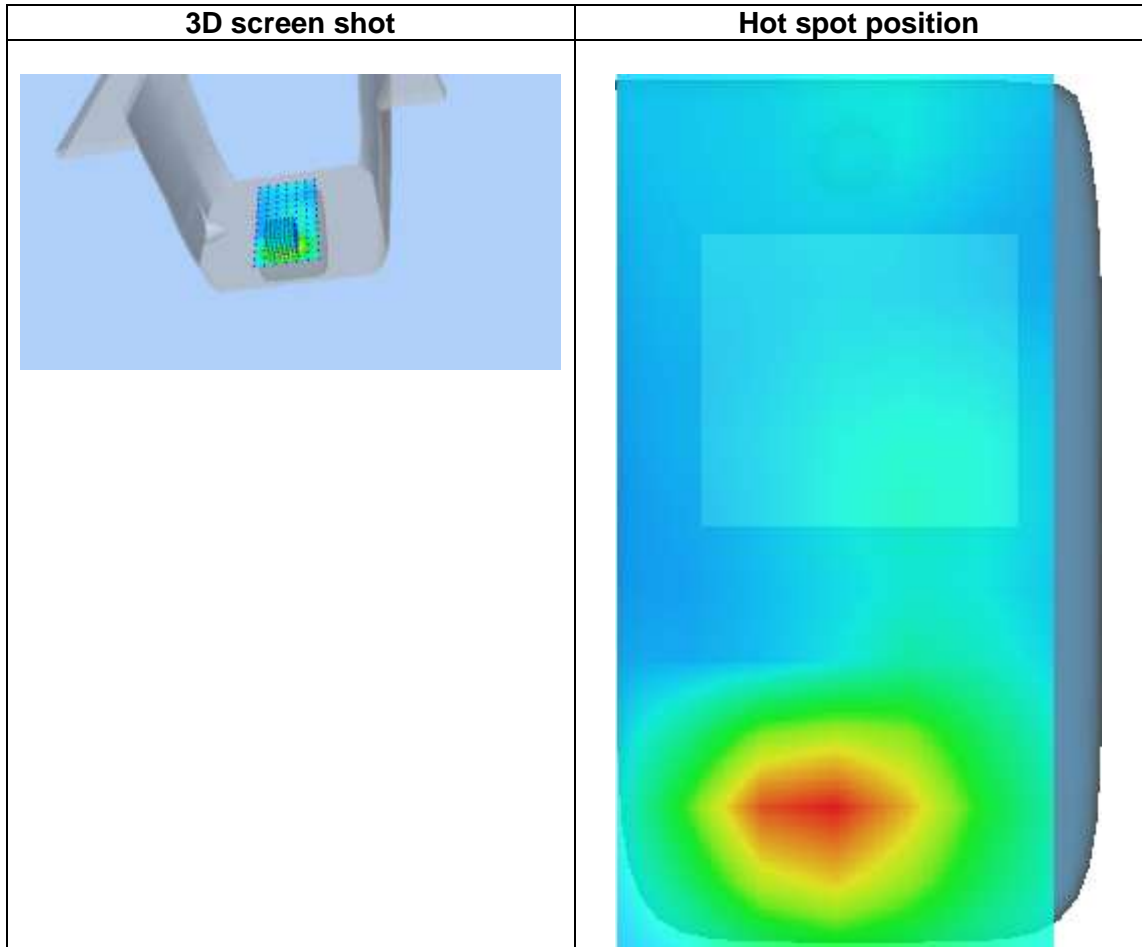
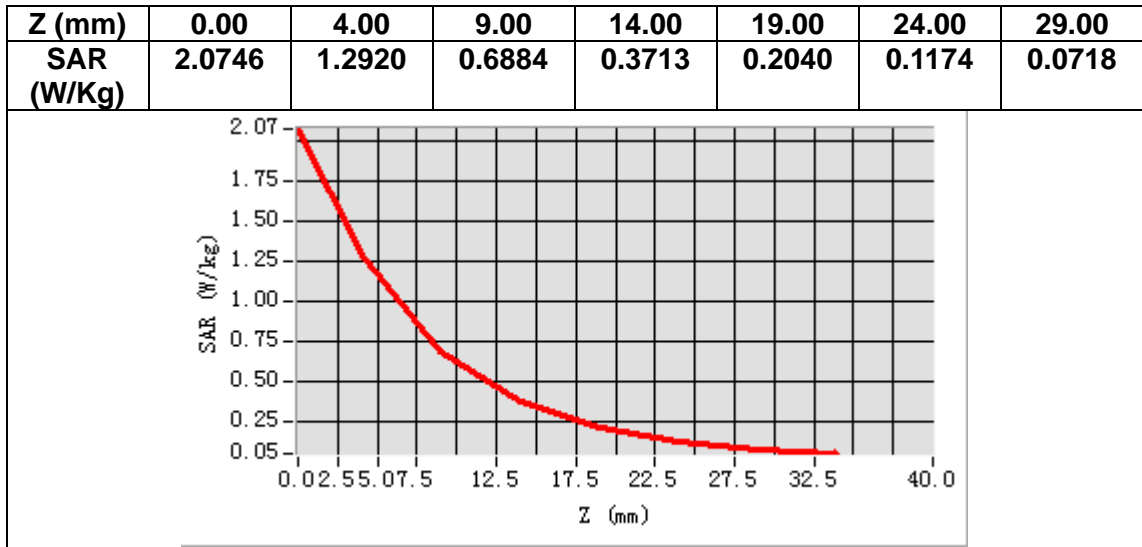

# MEASUREMENT 27

Date of measurement: 8/10/2024

## A. Experimental conditions.

<b>Area Scan</b>	<u>dx=15mm dy=15mm, h= 5.00 mm</u>
<b>ZoomScan</b>	<u>5x5x7, dx=8mm dy=8mm dz=5mm</u>
<b>Phantom</b>	<u>Left head</u>
<b>Device Position</b>	<u>Cheek</u>
<b>Band</b>	<u>LTE band 12</u>
<b>Channels</b>	<u>Middle</u>
<b>Signal</b>	<u>LTE (Crest factor: 1.0)</u>
<b>ConvF</b>	<u>2.42</u>

## B. SAR Measurement Results

<b>Frequency (MHz)</b>	707.500000
<b>Relative permittivity (real part)</b>	40.967010
<b>Relative permittivity (imaginary part)</b>	21.744638
<b>Conductivity (S/m)</b>	0.854685
<b>Variation (%)</b>	1.980000

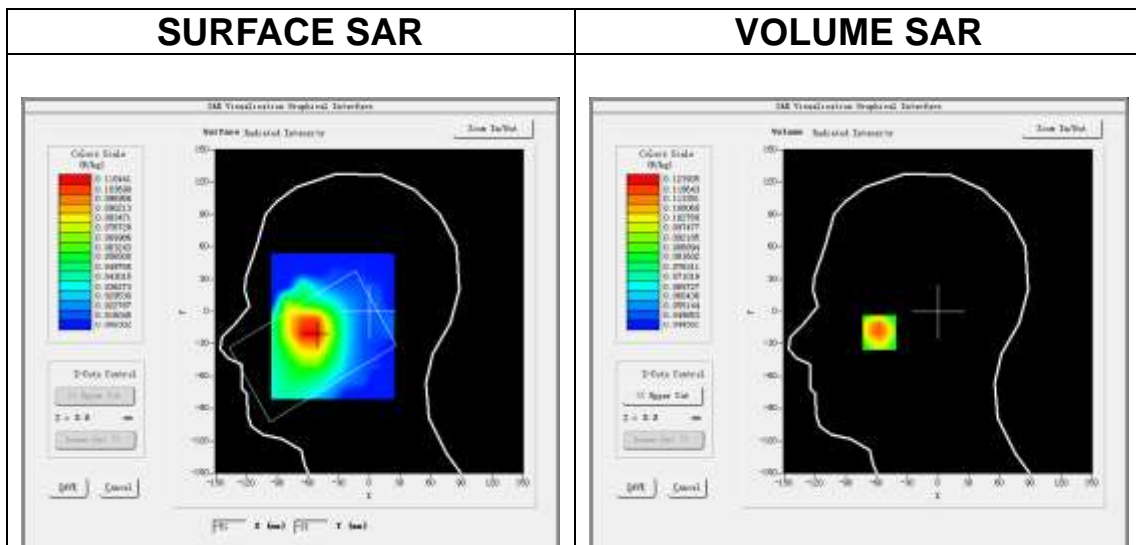

**Maximum location: X=-57.00, Y=-18.00**  
**SAR Peak: 0.11 W/kg**

<b>SAR 10g (W/Kg)</b>	0.109295
<b>SAR 1g (W/Kg)</b>	0.116971

Z (mm)	0.00	4.00	9.00	14.00	19.00	24.00	29.00
SAR (W/Kg)	3.7878	0.1239	0.1217	0.1148	0.1045	0.0942	0.0846

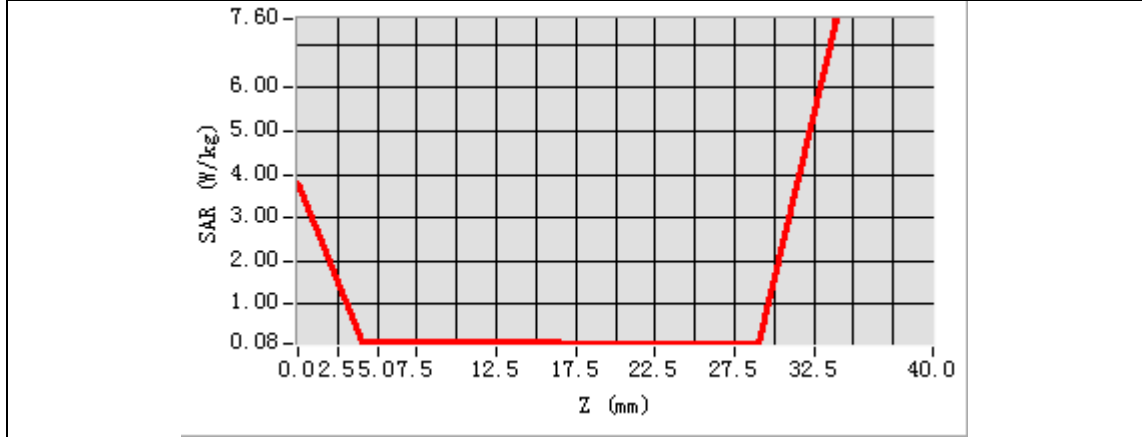

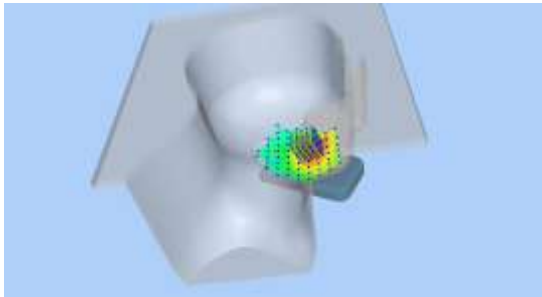
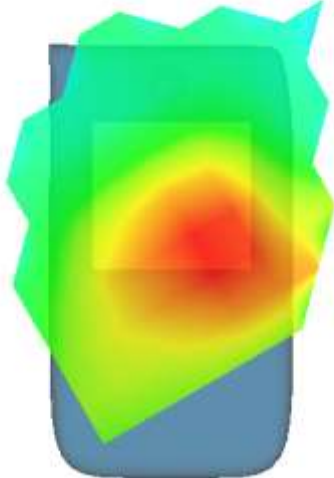
3D screen shot	Hot spot position
	



# MEASUREMENT 28

Date of measurement: 8/10/2024

## A. Experimental conditions.

<b>Area Scan</b>	<u>dx=15mm dy=15mm, h= 5.00 mm</u>
<b>ZoomScan</b>	<u>5x5x7, dx=8mm dy=8mm dz=5mm</u>
<b>Phantom</b>	<u>Validation plane</u>
<b>Device Position</b>	<u>Body</u>
<b>Band</b>	<u>LTE band 12</u>
<b>Channels</b>	<u>Middle</u>
<b>Signal</b>	<u>LTE (Crest factor: 1.0)</u>
<b>ConvF</b>	<u>2.42</u>

## B. SAR Measurement Results

<b>Frequency (MHz)</b>	707.500000
<b>Relative permittivity (real part)</b>	40.967010
<b>Relative permittivity (imaginary part)</b>	21.744638
<b>Conductivity (S/m)</b>	0.854685
<b>Variation (%)</b>	-0.500000

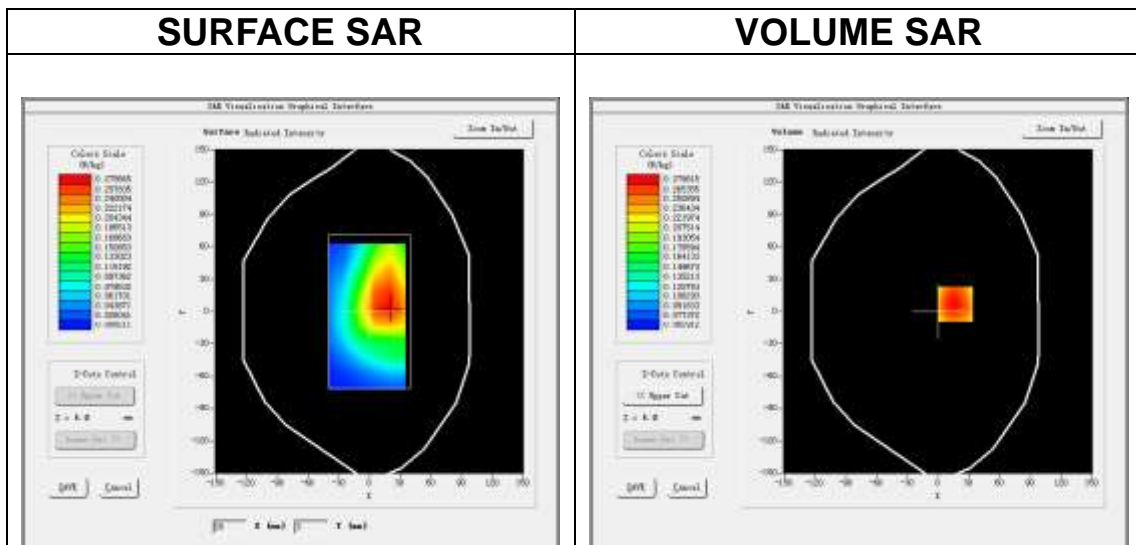

**Maximum location: X=17.00, Y=7.00**  
**SAR Peak: 0.31 W/kg**

<b>SAR 10g (W/Kg)</b>	0.236532
<b>SAR 1g (W/Kg)</b>	0.275131

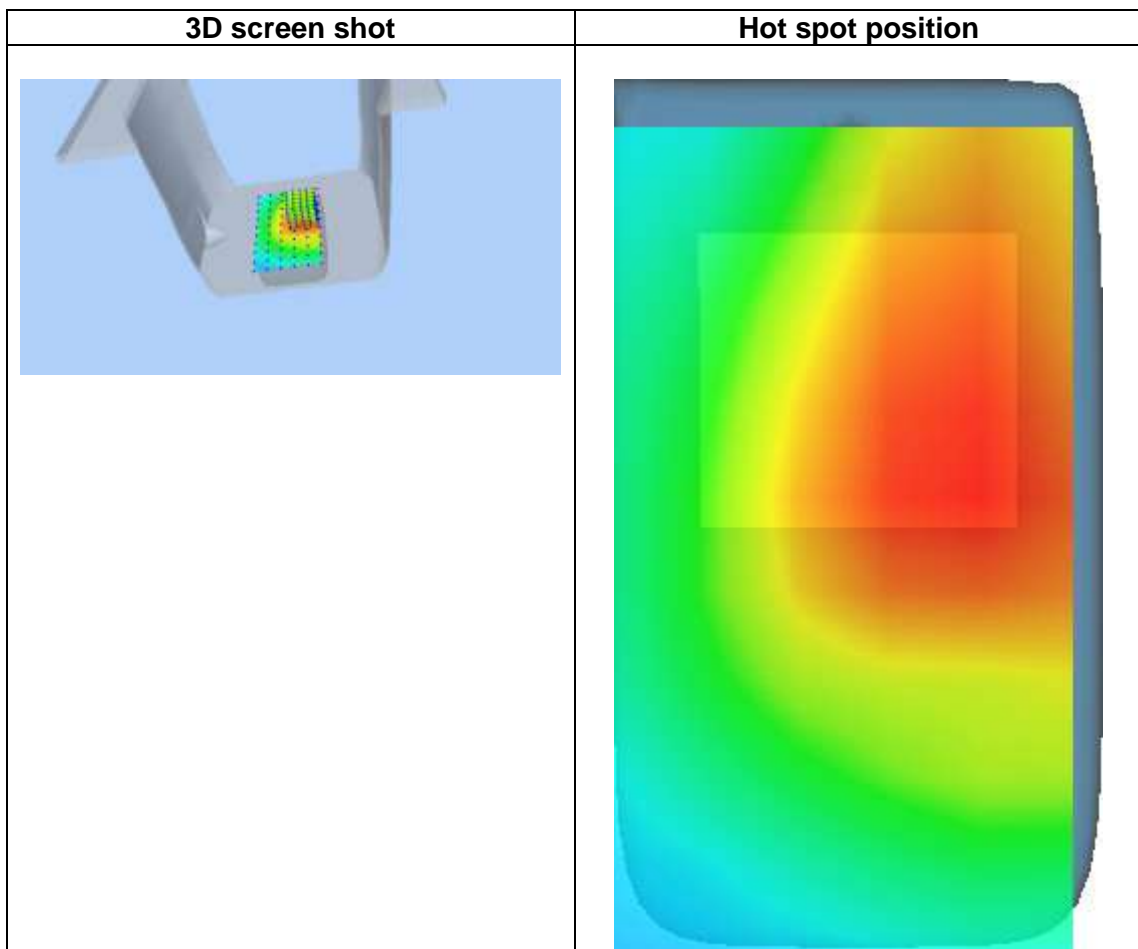
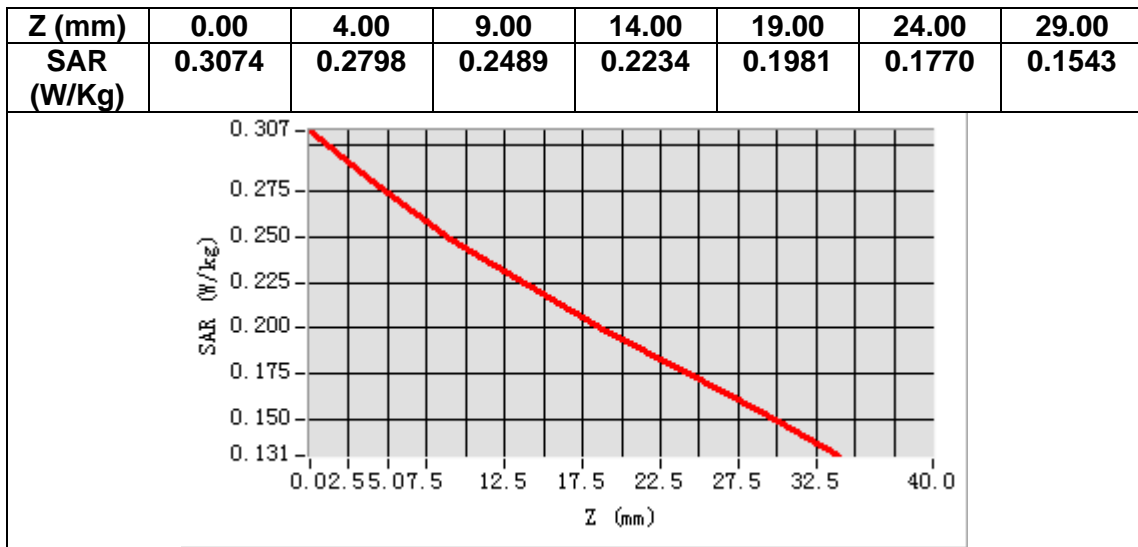

# MEASUREMENT 29

Date of measurement: 8/10/2024

## A. Experimental conditions.

<b>Area Scan</b>	<u>dx=15mm dy=15mm, h= 5.00 mm</u>
<b>ZoomScan</b>	<u>5x5x7,dx=8mm dy=8mm dz=5mm</u>
<b>Phantom</b>	<u>Left head</u>
<b>Device Position</b>	<u>Cheek</u>
<b>Band</b>	<u>LTE band 17</u>
<b>Channels</b>	<u>Middle</u>
<b>Signal</b>	<u>LTE (Crest factor: 1.0)</u>
<b>ConvF</b>	<u>2.42</u>

## B. SAR Measurement Results

<b>Frequency (MHz)</b>	710.000000
<b>Relative permittivity (real part)</b>	40.951660
<b>Relative permittivity (imaginary part)</b>	21.685087
<b>Conductivity (S/m)</b>	0.855356
<b>Variation (%)</b>	-1.440000

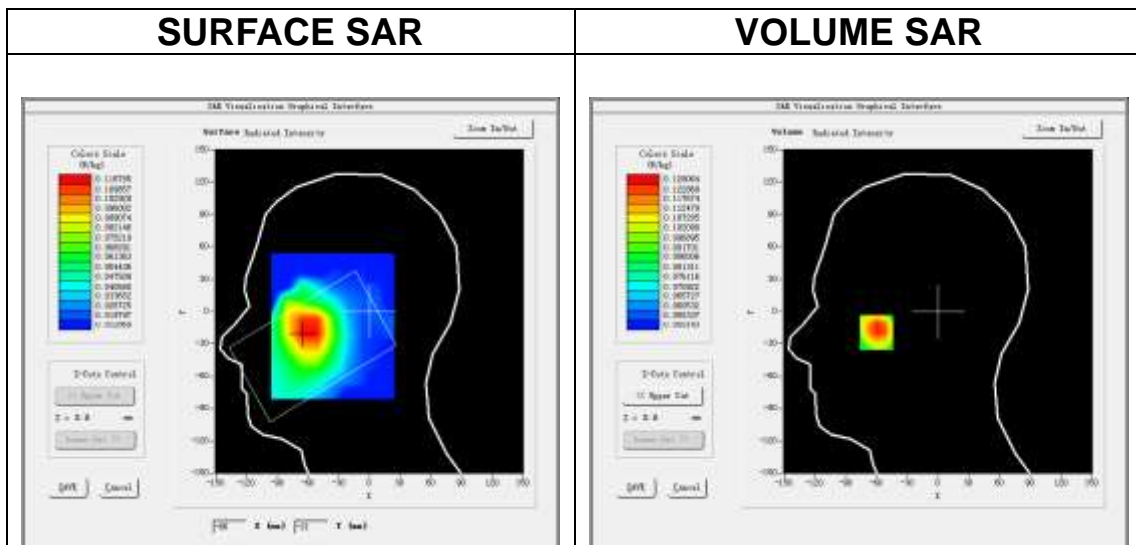

**Maximum location: X=-60.00, Y=-18.00**  
**SAR Peak: 0.12 W/kg**

<b>SAR 10g (W/Kg)</b>	0.115110
<b>SAR 1g (W/Kg)</b>	0.125034

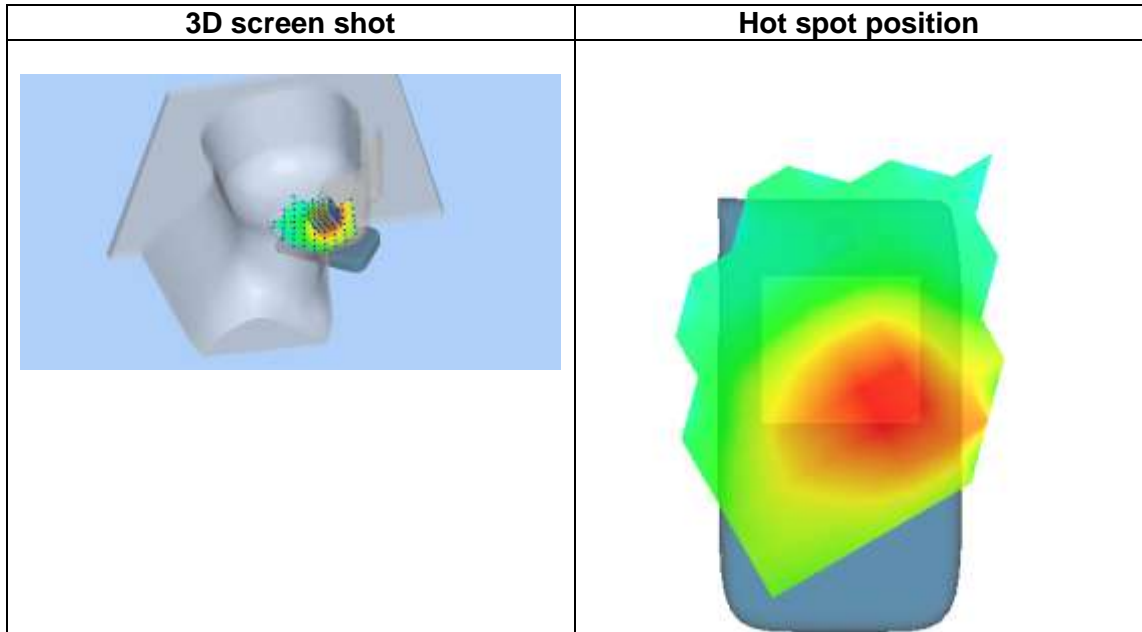
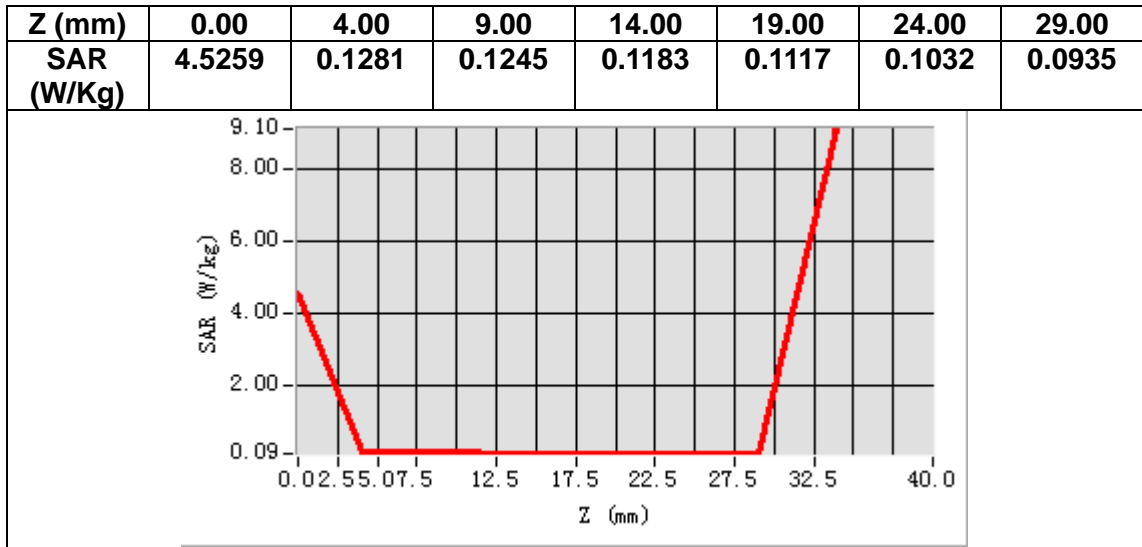

# MEASUREMENT 30

Date of measurement: 8/10/2024

## A. Experimental conditions.

<b>Area Scan</b>	<u>dx=15mm dy=15mm, h= 5.00 mm</u>
<b>ZoomScan</b>	<u>5x5x7, dx=8mm dy=8mm dz=5mm</u>
<b>Phantom</b>	<u>Validation plane</u>
<b>Device Position</b>	<u>Body</u>
<b>Band</b>	<u>LTE band 17</u>
<b>Channels</b>	<u>Middle</u>
<b>Signal</b>	<u>LTE (Crest factor: 1.0)</u>
<b>ConvF</b>	<u>2.42</u>

## B. SAR Measurement Results

<b>Frequency (MHz)</b>	710.000000
<b>Relative permittivity (real part)</b>	40.951660
<b>Relative permittivity (imaginary part)</b>	21.685087
<b>Conductivity (S/m)</b>	0.855356
<b>Variation (%)</b>	-0.260000

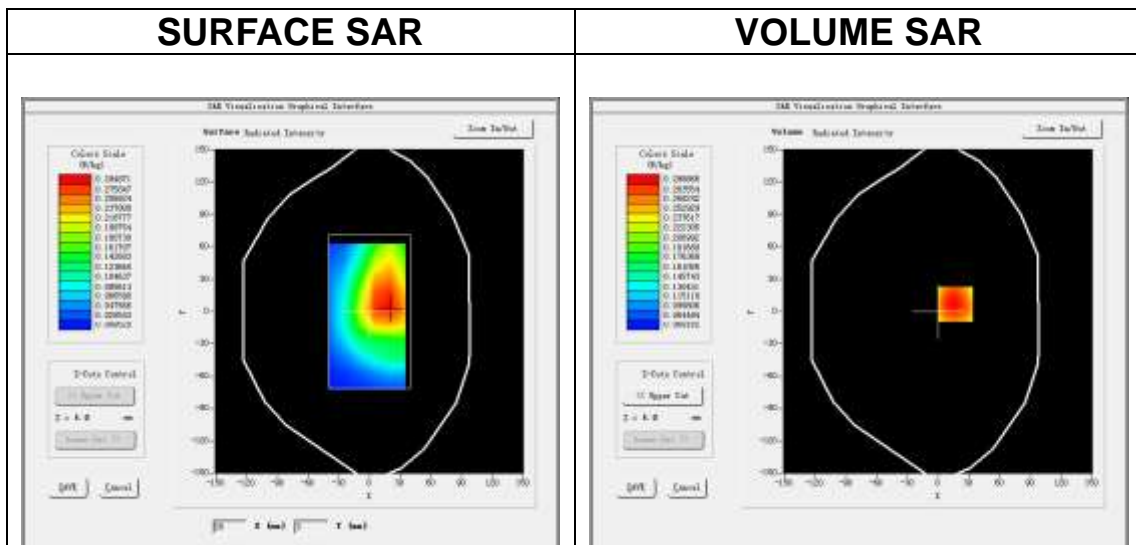

**Maximum location: X=17.00, Y=7.00**

**SAR Peak: 0.34 W/kg**

<b>SAR 10g (W/Kg)</b>	0.252333
<b>SAR 1g (W/Kg)</b>	0.294057

Z (mm)	0.00	4.00	9.00	14.00	19.00	24.00	29.00
SAR (W/Kg)	0.3323	0.2989	0.2642	0.2361	0.2113	0.1897	0.1665

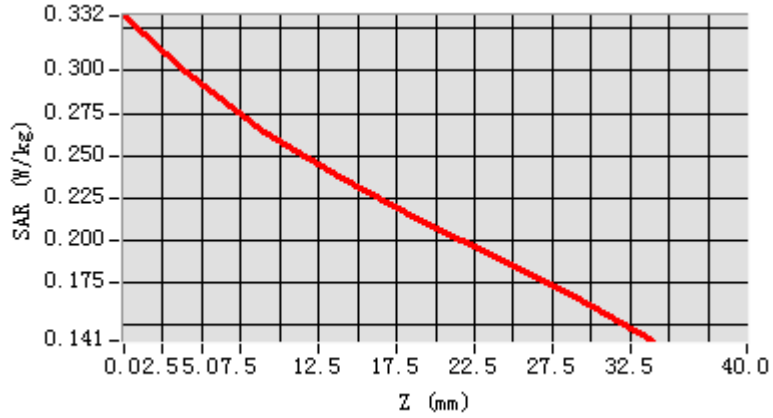

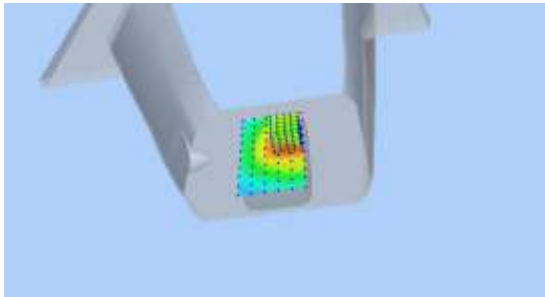
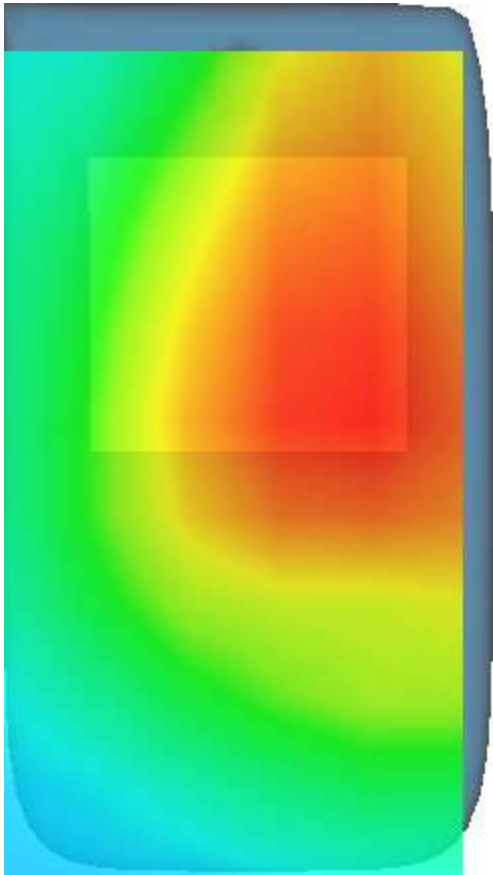
3D screen shot	Hot spot position
	

# MEASUREMENT 31

Date of measurement: 13/10/2024

## A. Experimental conditions.

<b>Area Scan</b>	<u>dx=12mm dy=12mm, h= 5.00 mm</u>
<b>ZoomScan</b>	<u>7x7x7,dx=5mm dy=5mm dz=5mm</u>
<b>Phantom</b>	<u>Left head</u>
<b>Device Position</b>	<u>Cheek</u>
<b>Band</b>	<u>LTE band 41</u>
<b>Channels</b>	<u>Middle</u>
<b>Signal</b>	<u>LTE (Crest factor: 1.0)</u>
<b>ConvF</b>	<u>2.65</u>

## B. SAR Measurement Results

<b>Frequency (MHz)</b>	2593.000000
<b>Relative permittivity (real part)</b>	39.004242
<b>Relative permittivity (imaginary part)</b>	14.080588
<b>Conductivity (S/m)</b>	2.028387
<b>Variation (%)</b>	-1.810000

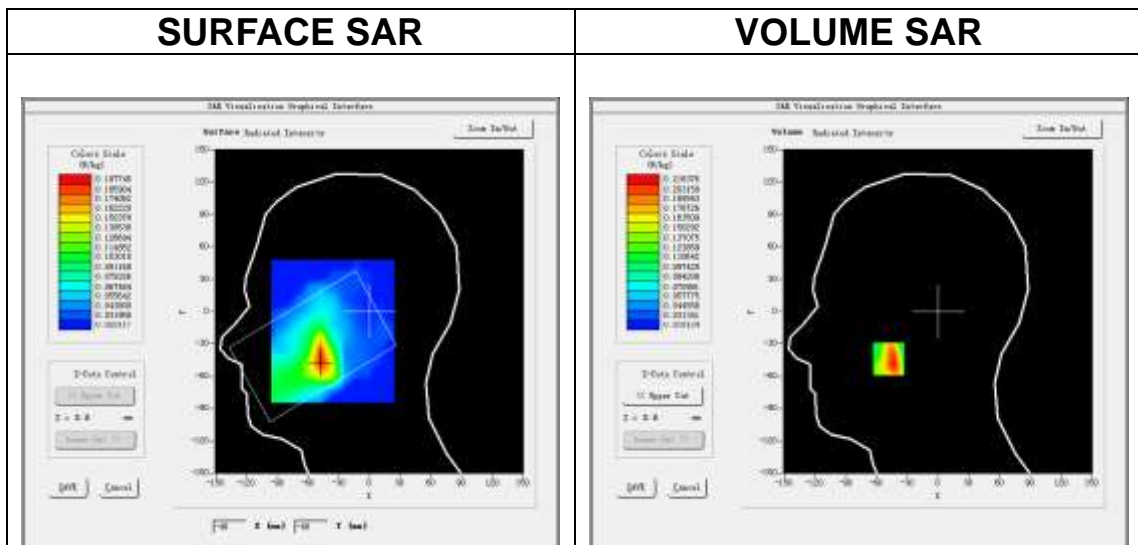

**Maximum location: X=-48.00, Y=-44.00**  
**SAR Peak: 0.32 W/kg**

<b>SAR 10g (W/Kg)</b>	0.114783
<b>SAR 1g (W/Kg)</b>	0.204091

Z (mm)	0.00	4.00	9.00	14.00	19.00	24.00	29.00
SAR (W/Kg)	0.3987	0.2164	0.0993	0.0855	0.0510	0.0419	0.0296

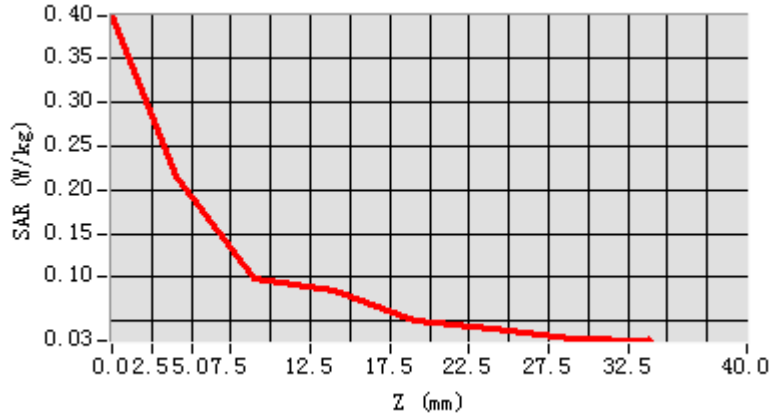

3D screen shot	Hot spot position
