

SAR TEST REPORT

Report No.: DDT-B22080104-1E01

Applicant	:	arpara Technology Co.,Ltd.
Applicant Address	:	Room 109 1/F Building 36, Nantaihu Dongyuan Business Building High-tech Zone, Wuxing District, Huzhou City, Zhejiang Province China
Equipment Under Test	:	arpara AIO 5K
Model No.	:	VRM1020WNA
Series Model No.	:	N/A
Trade Mark	:	
FCC ID	:	2A77G-VRM1020
IC ID	:	N/A
Manufacturer	:	arpara Technology Co.,Ltd.
Manufacturer Address	:	Room 109 1/F Building 36, Nantaihu Dongyuan Business Building High-tech Zone, Wuxing District, Huzhou City, Zhejiang Province China

Issued By: Tianjin Dongdian Testing Service Co., Ltd.

Address: Building D-1, No. 19 Weisi Road, Microelectronics Industrial Park, Development Area, Tianjin, China.

Tel: +86-22-58038033, E-mail: ddt@dddt.com, <http://www.ddttest.com>



REPORT

Table of Contents

1.	Summary of Test Results.....	7
1.1.	Report SAR results	7
1.2.	RF exposure limits	7
2.	General Test Information	8
2.1.	Description of EUT	8
2.2.	RF Channel Information.....	9
2.3.	Accessories of EUT.....	11
2.4.	Assistant equipment used for test.....	11
2.5.	Block diagram of EUT configuration for test.....	11
2.6.	Test environment conditions	12
2.7.	Test laboratory	12
3.	SAR Measurements System Configuration	13
3.1.	The SAR Measurement System	13
3.2.	Isotropic E-field Probe EX3DV4.....	14
3.3.	SAM Twin Phantom	14
3.4.	ELI Phantom.....	15
3.5.	Data Acquisition Electronics (DAE).....	15
3.6.	Device Holder for Transmitters	16
4.	Measurement procedure	17
4.1.	Scanning procedure	17
5.	Description of Test Position	19
5.1.	Body-Worn Accessory Configurations	19
5.2.	Extremity exposure configurations.....	20
6.	RF Exposure Conditions	21
6.1.	EUT sides and antenna position	21
6.2.	Standalone SAR Test Exclusion Considerations.....	22
6.3.	Test sides and test exclusion.....	23
7.	SAR System Verification Procedure	27
7.1.	Tissue Simulate Liquid	27
7.1.1.	Target dielectric properties of head tissue-equivalent material	27
7.1.2.	Measurement for Tissue Simulate Liquid	27
7.2.	SAR System Validation	29
7.2.1.	Justification for Extended SAR Dipole Calibrations.....	29
7.2.2.	Validation Test Setup Photograph	30
7.2.3.	Summary System Validation Results.....	30
7.2.4.	Detailed System Validation Results.....	31

8.	Equipment list.....	32
9.	Measurement Uncertainty.....	33
10.	Test results and Measurement Data.....	34
10.1.	RF conducted Power.....	34
10.2.	Measurement of Head SAR Data.....	40
10.3.	Measurement of Extremities SAR Data.....	43
10.4.	Simultaneous transmission SAR.....	46
	Appendix.....	50

Test Report Declare

Applicant	:	arpara Technology Co.,Ltd.
Address	:	Room 109 1/F Building 36, Nantaihu Dongyuan Business Building High-tech Zone, Wuxing District, Huzhou City, Zhejiang Province China
Equipment under Test	:	arpara AIO 5K
Model No.	:	VRM1020WNA
Series Model No.	:	N/A
Trade Mark	:	
Manufacturer	:	arpara Technology Co.,Ltd.
Address	:	Room 109 1/F Building 36, Nantaihu Dongyuan Business Building High-tech Zone, Wuxing District, Huzhou City, Zhejiang Province China

Test Standard Used:

IEEE Std. 1528-2013; IEC/IEEE 62209-1528:2020

FCC Rules and Regulations: 47 CFR § 2.1093

ISED Rules and Regulations: RSS-102 Issue5, Mar. 2015

Test Procedure Used:

KDB447498 D01 v06, KDB 248227 D01 v02r02, KDB 865664 D01 v01r04, KDB 865664 D02 v01r02

We Declare:

The equipment described above is tested by Tianjin Dongdian Testing Service Co., Ltd and in the configuration tested the equipment complied with the standards specified above. The test results are contained in this test report and Tianjin Dongdian Testing Service Co., Ltd is assumed of full responsibility for the accuracy and completeness of these tests.

After test and evaluation, our opinion is that the equipment provided for test compliance with the requirement of the above FCC and ISED standards.

Report No:	DDT-B22080104-1E01		
Date of Receipt:	Aug. 03, 2022	Date of Test:	Aug. 29, 2022 ~ Aug. 31, 2022

Prepared By:

Novak Wei

Novak Wei / Engineer

Approved By:

Leon Li



Leon Li / RF Manager

Note: This report applies to above tested sample only. This report shall not be reproduced in parts without written approval of Tianjin Dongdian Testing Service Co., Ltd.

The report must not be used by the client to claim product certification, approval, or endorsement

by NVLAP, NIST, or any agency of the U.S. Government.

Revision History

Rev.	Revisions	Issue Date	Revised By
---	Initial issue	Sep. 22, 2022	

1. Summary of Test Results

1.1. Report SAR results

Band	Test Position	Max. Reported SAR (W/kg)	SAR limit (W/kg)	Verdict
Bluetooth	Head(1-g) 0mm	0.1612	1.6	Pass
	Extremities(10-g) 0mm	0.0700	4.0	Pass
WIFI_2.4G	Head(1-g) 0mm	1.1471	1.6	Pass
	Extremities(10-g) 0mm	0.5747	4.0	Pass
WIFI_5G	Head(1-g) 0mm	1.1680	1.6	Pass
	Extremities(10-g) 0mm	0.3656	4.0	Pass
Simultaneous Transmission	Head(1-g) 0mm	1.3218	1.6	Pass
	Extremities(10-g) 0mm	1.3575	4.0	Pass

1.2. RF exposure limits

Human Exposure	Uncontrolled Environment General Population	Controlled Environment Occupational
Spatial Average SAR** (Whole Body)	0.08 W/kg	0.40 W/kg
Spatial Peak SAR* (Brain*Trunk)	1.60 W/kg	8.00 W/kg
Spatial Peak SAR*** (Hands/Feet/Ankle/Wrist)	4.00 W/kg	20.00 W/kg

Notes:

- 1) The Spatial Peak value of the SAR averaged over any 1 gram of tissue (defined as a tissue volume in the shape of a cube) and over the appropriate averaging time
- 2) The Spatial Average value of the SAR averaged over the whole body.
- 3) The Spatial Peak value of the SAR averaged over any 10 grams of tissue (defined as a tissue volume in the shape of a cube) and over the appropriate averaging time.
- 4) Uncontrolled Environments are defined as locations where there is the exposure of individuals who have no knowledge or control of their exposure.
- 5) Controlled Environments are defined as locations where there is exposure that may be incurred by persons who are aware of the potential for exposure, (i.e. as a result of employment or occupation.)

2. General Test Information

2.1. Description of EUT

EUT Description	: arpara AIO 5K
Model Number	: VRM1020WNA
Series Model Number	: N/A
Models different	: N/A
Trade Mark	: arpara
Serial Number	: N/A
Sample Type	: Portable Device
Radio Specification	: Bluetooth: BR/EDR; BLE : WIFI_2.4G: IEEE 802.11b/g/n/ax : WIFI_5G: IEEE 802.11a/n/ac/ax
Frequency Range	: BR/EDR: 2402-2480MHz BLE: 2402-2480MHz WIFI_2.4G: IEEE 802.11b: 2412MHz-2462MHz IEEE 802.11g: 2412MHz-2462MHz IEEE 802.11n HT20: 2412MHz-2462MHz IEEE 802.11n HT40: 2422MHz-2452MHz IEEE 802.11ax HT20:2412MHz-2462MHz IEEE 802.11ax HT40:2422MHz-2452MHz WIFI_5G: IEEE 802.11a: 5180MHz-5240MHz, 5260MHz-5320MHz, 5500MHz-5700MHz, 5745MHz-5825MHz IEEE 802.11n HT20: 5180MHz-5240MHz, 5260MHz-5320MHz, 5500MHz-5700MHz, 5745MHz-5825MHz IEEE 802.11n HT40: 5190MHz-5230MHz, 5270MHz-5310MHz, 5510MHz-5670MHz, 5755MHz-5795MHz IEEE 802.11ac HT20: 5180MHz-5240MHz, 5260MHz-5320MHz, 5500MHz-5700MHz, 5745MHz-5825MHz IEEE 802.11ac HT40: 5190MHz-5230MHz, 5270MHz-5310MHz, 5510MHz-5670MHz, 5755MHz-5795MHz IEEE 802.11ax HT20: 5180MHz-5240MHz,5260MHz-5320MHz, 5500MHz-5700MHz, 5745MHz-5825MHz IEEE 802.11ax HT40: 5190MHz-5230MHz, 5270MHz-5310MHz, 5510MHz-5670MHz, 5755MHz-5795MHz IEEE 802.11ax HT80: 5210MHz, 5290MHz, 5530MHz, 5610 MHz, 5775MHz
Modulation	: BR/EDR: GFSK, $\pi/4$ -DQPSK, 8-DPSK BLE: GFSK WIFI_2.4G: IEEE 802.11b: DSSS (CCK, DQPSK, DBPSK) IEEE 802.11g: OFDM (64QAM, 16QAM, QPSK, BPSK) IEEE 802.11n HT20, HT40: OFDM (64QAM, 16QAM, QPSK, BPSK) IEEE 802.11ax: HT20, HT40, HT80: OFDM (256QAM, 64QAM, 16QAM, QPSK, BPSK) WIFI_5G: IEEE 802.11a: OFDM (64QAM, 16QAM, QPSK, BPSK) IEEE 802.11n HT20, HT40: OFDM (64QAM, 16QAM, QPSK, BPSK) IEEE 802.11ac HT20, HT40: OFDM (64QAM, 16QAM, QPSK, BPSK) IEEE 802.11ax: HT20, HT40, HT80: OFDM (256QAM, 64QAM, 16QAM, QPSK, BPSK)
Date Rate	: BR/EDR: 1Mbps, 2Mbps, 3Mbps : BLE: 1Mbps

	WIFI_2.4G: IEEE 802.11b: 1, 2, 5.5, 11 Mbps IEEE 802.11g: 6, 9, 12, 18, 24, 36, 48, 54 Mbps IEEE 802.11n HT20, HT40: MCS0~MCS15 IEEE 802.11ax HT20, HT40, HT80: MCS0~MCS9 WIFI_5G: IEEE 802.11a: 6, 9, 12, 18, 24, 36, 48, 54 Mbps IEEE 802.11n HT20, HT40: MCS0~MCS15 IEEE 802.11ac HT20, HT40: MCS0~MCS8 IEEE 802.11ax HT20, HT40, HT80: MCS0~MCS9
Antenna Type	: FPC antenna
Antenna Gain	ANT1 BR/EDR: Maximum PK gain 2.15dBi BLE: Maximum PK gain 2.15dBi WIFI_2.4G: Maximum PK gain 2.15dBi WIFI_5G: Maximum PK gain 4.94dBi ANT2 WIFI_2.4G: Maximum PK gain 2.97dBi WIFI_5G: Maximum PK gain 5.45dBi
Power Supply	: DC 3.85V built-in battery

Note: EUT is the abbreviation of equipment under test.

2.2. RF Channel Information

BR/EDR	Lowest Range(L)	Middle Range(M)	Highest Range(H)
Channel	0	39	78
Frequency	2402MHz	2441MHz	2480MHz

BLE	Lowest Range(L)	Middle Range(M)	Highest Range(H)
Channel	0	19	39
Frequency	2402MHz	2440MHz	2480MHz

WIFI_2.4G		Lowest Range(L)	Middle Range(M)	Highest Range(H)
IEEE 802.11b	Channel	1	6	11
	Frequency	2412MHz	2437MHz	2462MHz
IEEE 802.11g	Channel	1	6	11
	Frequency	2412MHz	2437MHz	2462MHz
IEEE 802.11n HT20	Channel	1	6	11
	Frequency	2412MHz	2437MHz	2462MHz
IEEE 802.11n HT40	Channel	3	6	9
	Frequency	2422MHz	2437MHz	2452MHz
IEEE 802.11ax HT20	Channel	1	6	11
	Frequency	2412MHz	2437MHz	2462MHz
IEEE 802.11ax HT40	Channel	3	6	9
	Frequency	2422MHz	2437MHz	2452MHz

WIFI_5G_U-NII-1		Lowest Range(L)	Middle Range(M)	Highest Range(H)
IEEE 802.11a	Channel	36	40	48
	Frequency	5180MHz	5200MHz	5240MHz

IEEE 802.11n HT20	Channel	36	40	48
	Frequency	5180MHz	5200MHz	5240MHz
IEEE 802.11n HT40	Channel	38	N/A	46
	Frequency	5190MHz	N/A	5230MHz
IEEE 802.11ac HT20	Channel	36	40	48
	Frequency	5180MHz	5200MHz	5240MHz
IEEE 802.11ac HT40	Channel	38	N/A	46
	Frequency	5190MHz	N/A	5230MHz
IEEE 802.11ax HT20	Channel	36	40	48
	Frequency	5180MHz	5200MHz	5240MHz
IEEE 802.11ax HT40	Channel	38	N/A	46
	Frequency	5190MHz	N/A	5230MHz
IEEE 802.11ax HT80	Channel	N/A	42	N/A
	Frequency	N/A	5210MHz	N/A

WIFI_5G_U-NII-2A		Lowest Range(L)	Middle Range(M)	Highest Range(H)
IEEE 802.11a	Channel	52	56	64
	Frequency	5260MHz	5280MHz	5320MHz
IEEE 802.11n HT20	Channel	52	56	64
	Frequency	5260MHz	5280MHz	5320MHz
IEEE 802.11n HT40	Channel	54	N/A	62
	Frequency	5270MHz	N/A	5310MHz
IEEE 802.11ac HT20	Channel	52	56	64
	Frequency	5260MHz	5280MHz	5320MHz
IEEE 802.11ac HT40	Channel	54	N/A	62
	Frequency	5270MHz	N/A	5310MHz
IEEE 802.11ax HT20	Channel	52	56	64
	Frequency	5260MHz	5280MHz	5320MHz
IEEE 802.11ax HT40	Channel	54	N/A	62
	Frequency	5270MHz	N/A	5310MHz
IEEE 802.11ax HT80	Channel	N/A	58	N/A
	Frequency	N/A	5290MHz	N/A

WIFI_5G_U-NII-2C		Lowest Range(L)	Middle Range(M)	Highest Range(H)
IEEE 802.11a	Channel	100	116	140
	Frequency	5500MHz	5580MHz	5700MHz
IEEE 802.11n HT20	Channel	100	116	140
	Frequency	5500MHz	5580MHz	5700MHz
IEEE 802.11n HT40	Channel	102	110	134
	Frequency	5510MHz	5550MHz	5670MHz
IEEE 802.11ac HT20	Channel	100	116	140
	Frequency	5500MHz	5580MHz	5700MHz
IEEE 802.11ac HT40	Channel	102	110	134
	Frequency	5510MHz	5550MHz	5670MHz
IEEE 802.11ax HT20	Channel	100	116	140
	Frequency	5500MHz	5580MHz	5700MHz
IEEE 802.11ax HT40	Channel	102	110	134
	Frequency	5510MHz	5550MHz	5670MHz
IEEE 802.11ax	Channel	106	N/A	122

HT80	Frequency	5530MHz	N/A	5610MHz
WIFI_5G_U-NII-3		Lowest Range(L)	Middle Range(M)	Highest Range(H)
IEEE 802.11a	Channel	149	157	165
	Frequency	5745MHz	5785MHz	5825MHz
IEEE 802.11n HT20	Channel	149	157	165
	Frequency	5745MHz	5785MHz	5825MHz
IEEE 802.11n HT40	Channel	151	N/A	159
	Frequency	5755MHz	N/A	5795MHz
IEEE 802.11ac HT20	Channel	149	157	165
	Frequency	5745MHz	5785MHz	5825MHz
IEEE 802.11ac HT40	Channel	151	N/A	159
	Frequency	5755MHz	N/A	5795MHz
IEEE 802.11ax HT20	Channel	149	157	165
	Frequency	5745MHz	5785MHz	5825MHz
IEEE 802.11ax HT40	Channel	151	N/A	159
	Frequency	5755MHz	N/A	5795MHz
IEEE 802.11ax HT80	Channel	N/A	155	N/A
	Frequency	N/A	5775MHz	N/A

2.3. Accessories of EUT

Description of Accessories	Manufacturer	Model number	Description	Remark
N/A	N/A	N/A	N/A	N/A

2.4. Assistant equipment used for test

Assistant equipment	Manufacturer	Model number	EMC Compliance	SN
Notebook	Lenovo Beijing Co. Ltd.	ThinkPad T450	FCC/CE	SL10H72009

2.5. Block diagram of EUT configuration for test



Test software: ARDC.exe&QRCT.exe

2.6. Test environment conditions

During the measurement the environmental conditions were within the listed ranges:

Condition	Normal Condition	Extreme Condition
Pressure range	86-106KPa	N/A
Relative Humidity	30-75%	N/A
Temperature(°C)	22°C-25°C	N/A
Voltage(V)	3.85V	N/A

2.7. Test laboratory

Tianjin Dongdian Testing Service Co., Ltd.

Address: Building D-1, No. 19, Weisi Road, Microelectronics Industrial Park Development Area,
Tianjin, China., 300385

Tel: +86-22-58038033, <http://www.ddttest.com>, Email: ddt@dgddt.com

NVLAP (National Voluntary Laboratory Accreditation Program) CODE: 500036-0

CNAS (China National Accreditation Service for Conformity Assessment) CODE: L13402

FCC Designation Number: CN5004; FCC Test Firm Registration Number: 368676

ISED (Innovation, Science and Economic Development Canada) Company Number: 27768

Conformity Assessment Body Identifier: CN0125

VCCI Facility Registration Number: C-20089, T-20093, R-20125, G-20122

3. SAR Measurements System Configuration

3.1. The SAR Measurement System

This SAR Measurement System uses a computer-controlled 3-D stepper motor system (SPEAG DASY5 professional system). A E-field probe is used to determine the internal electric fields. The SAR can be obtained from the equation $SAR = \sigma (|E|^2) / \rho$ where σ and ρ are the conductivity and mass density of the tissue-Simulate.

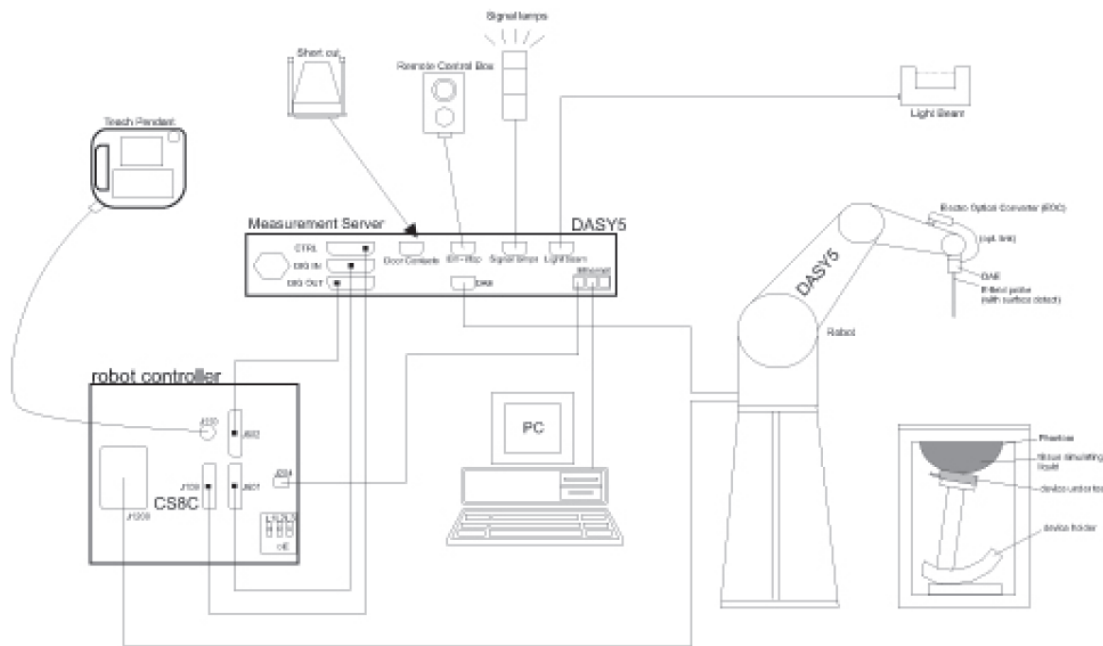

The DASY5 system for performing compliance tests consists of the following items:

- A standard high precision 6-axis robot (Stabile RX family) with controller, teach pendant and software. An arm extension for accommodation the data acquisition electronics (DAE).
- An isotropic E-field probe optimized and calibrated for usage in tissue simulating liquid. The probe is equipped with an optical surface detector system.
- A data acquisition electronics (DAE) which performs the signal amplification, signal multiplexing, AD-conversion, offset measurements, mechanical surface detection, collision detection, etc. The unit is battery powered with standard or rechargeable batteries. The signal is optically transmitted to the EOC.
- The Electro-optical converter (EOC) performs the conversion between optical and electrical of the signals for the digital communication to DAE and for the analog signal from the optical surface detection. The EOC is connected to the measurement server.
- The function of the measurement server is to perform the time critical tasks such as signal filtering, control of the robot operation and fast movement interrupts.
- A probe alignment unit which improves the (absolute) accuracy of the probe positioning.
- A computer operating Windows 7.
- DASY52 software.

- Remote control with teach pendant and additional circuitry for robot safety such as warning lamps, etc.
- The SAM twin phantom enabling testing left-hand, right-hand and Body Worn usage.
- The device holder for handheld mobile phones.
- Tissue simulating liquid mixed according to the given recipes.
- Validation dipole kits allowing to validating the proper functioning of the system.

3.2. Isotropic E-field Probe EX3DV4

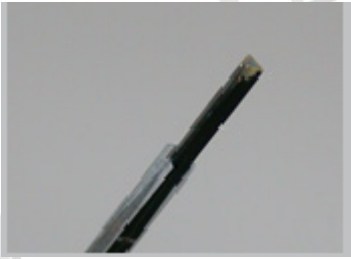
	Symmetrical design with triangular core Built-in shielding against static charges PEEK enclosure material (resistant to organic solvents, e.g., DGBE)
Calibration	ISO/IEC 17025 calibration service available.
Frequency	10 MHz to > 6 GHz Linearity: ± 0.2 Db (30 MHz to 6 GHz)
Directivity	± 0.3 Db in TSL (rotation around probe axis) ± 0.5 Db in TSL (rotation normal to probe axis)
Dynamic Range	10 μ W/g to > 100 Mw/g Linearity: ± 0.2 Db (noise: typically < 1 μ W/g)
Dimensions	Overall length: 337 mm (Tip: 20 mm) Tip diameter: 2.5 mm (Body: 12 mm) Typical distance from probe tip to dipole centers: 1 mm
Application	High precision dosimetric measurements in any exposure scenario (e.g., very strong gradient fields); the only probe that enables compliance testing for frequencies up to 6 GHz with precision of better 30%.
Compatibility	DASY3, DASY4, DASY52 SAR and higher, EASY4/MRI

3.3. SAM Twin Phantom

Material	Vinylester, glass fiber reinforced (VE-GF)	
Liquid Compatibility	Compatible with all SPEAG tissue simulating liquids (incl. DGBE type)	
Shell Thickness	2 ± 0.2 mm (6 ± 0.2 mm at ear point)	
Dimensions (incl. Wooden Support)	Length: 1000 mm Width: 500 mm Height: adjustable feet	
Filling Volume	14esolut. 25 liters	
Wooden Support	SPEAG standard phantom table	
The shell corresponds to the specifications of the Specific Anthropomorphic Mannequin (SAM) phantom defined in IEEE 1528 and IEC 62209-1. It enables the dosimetric evaluation of left and right hand phone usage		

as well as body mounted usage at the flat phantom region. A cover prevents evaporation of the liquid. Reference markings on the phantom allow the complete setup of all predefined phantom positions and measurement grids by teaching three points with the robot.

Twin SAM V5.0 has the same shell geometry and is manufactured from the same material as Twin SAM V4.0, but has reinforced top structure.

3.4. ELI Phantom

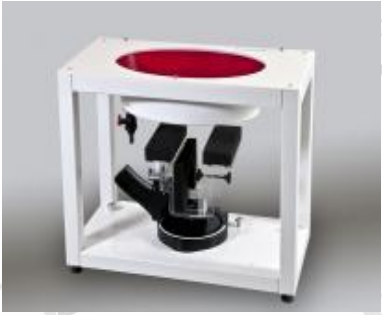
Material	Vinylester, glass fiber reinforced (VE-GF)	
Liquid Compatibility	Compatible with all SPEAG tissue simulating liquids (incl. DGBE type)	
Shell Thickness	2 ± 0.2 mm (bottom plate)	
Dimensions	Major axis: 600 mm Minor axis: 400 mm	
Filling Volume	15esolut. 30 liters	
Wooden Support	SPEAG standard phantom table	
<p>Phantom for compliance testing of handheld and body-mounted wireless devices in the frequency range of 30 MHz to 6 GHz. ELI is fully compatible with the IEC 62209-2 standard and all known tissue simulating liquids. ELI has been optimized regarding its performance and can be integrated into our standard phantom tables. A cover prevents evaporation of the liquid. Reference markings on the phantom allow installation of the complete setup, including all predefined phantom positions and measurement grids, by teaching three points. The phantom is compatible with all SPEAG dosimetric probes and dipoles.</p> <p>ELI V5.0 has the same shell geometry and is manufactured from the same material as ELI4, but has reinforced top structure.</p>		

3.5. Data Acquisition Electronics (DAE)

Model	DAE4	
Construction	Signal amplifier, multiplexer, A/D converter and control logic. Serial optical link for communication with DASY4/5 embedded system (fully remote controlled). Two step probe touch detector for mechanical surface detection and emergency robot stop.	
Measurement Range	-100 to +300 Mv (16 bit resolution and two range settings: 4Mv,400Mv)	
Input Offset Voltage	< 5Mv (with auto zero)	
Input Bias Current	< 50 f A	
Dimensions	60 x 60 x 68 mm	

3.6. Device Holder for Transmitters



The DASY device holder is designed to cope with different positions given in the standard. It has two scales for the device rotation (with respect to the body axis) and the device inclination (with respect to the line between the ear reference points). The rotation centres for both scales are the ear reference point (ERP). Thus the device needs no repositioning when changing the angles.

The DASY device holder has been made out of low-loss POM material having the following dielectric parameters: relative permittivity $\epsilon=3$ and loss tangent $\delta=0.02$. The amount of dielectric material has been reduced in the closest vicinity of the device, since measurements have suggested that the influence of the clamp on the test results could thus be lowered.

4. MEASUREMENT PROCEDURE

4.1. Scanning procedure

Step 1: Power reference measurement

The “reference” and “drift” measurements are located at the beginning and end of the batch process. They measure the field drift at one single point in the liquid over the complete procedure.

Step 2: Area scan

The SAR distribution at the exposed side of the head was measured at a distance of 4mm from the inner surface of the shell. The area covered the entire dimension of the head and the horizontal grid spacing was 15mm*15mm or 12mm*12mm or 10mm*10mm. Based on the area scan data, the area of the maximum absorption was determined by spline interpolation.

Step 3: Zoom scan

Around this point, a volume of 30mm*30mm*30mm (fine resolution volume scan, zoom scan) was assessed by measuring 5x5x7 points ($\leq 2\text{GHz}$) and 7x7x7 points ($\geq 2\text{GHz}$). On this basis of this data set, the spatial peak SAR value was evaluated with the following procedure:

The data at the surface was extrapolated, since the centre of the dipoles is 2.0mm away from the tip of the probe and the distance between the surface and the lowest measuring point is 1.2mm.

(This can be variable. Refer to the probe specification). The extrapolation was based on a least square algorithm. A polynomial of the fourth order was calculated through the points in z-axis.

This polynomial was then used to evaluate the points between the surface and the probe tip. The maximum interpolated value was searched with a straight-forward algorithm. Around this

maximum the SAR values averaged over the spatial volumes (1g or 10g) were computed using the 3D-Spline interpolation algorithm. The volume was integrated with the trapezoidal algorithm.

One thousand points were interpolated to calculate the average. All neighbouring volumes were evaluated until no neighboring volume with a higher average value was found.

The area and zoom scan resolutions specified in the table below must be applied to the SAR measurements. Probe boundary effect error compensation is required for measurements with the

probe tip closer than half a probe tip diameter to the phantom surface. Both the probe tip diameter and sensor offset distance must satisfy measurement protocols; to ensure probe

boundary effect errors are minimized and the higher fields closest to the phantom surface can be correctly measured and extrapolated to the phantom surface for computing 1-g SAR. Tolerances

of the post-processing algorithms must be verified by the test laboratory for the scan resolutions used in the SAR measurements, according to the reference distribution functions specified in

IEEE 1528-2013.

		≤ 3 GHz	> 3 GHz	
Maximum distance from closest measurement point (geometric center of probe sensors) to phantom surface		5 mm \pm 1 mm	$\frac{1}{2} \cdot \delta \cdot \ln(2)$ mm \pm 0.5 mm	
Maximum probe angle from probe axis to phantom surface normal at the measurement location		$30^\circ \pm 1^\circ$	$20^\circ \pm 1^\circ$	
Maximum area scan spatial resolution: Δx_{Area} , Δy_{Area}		≤ 2 GHz: ≤ 15 mm 2 – 3 GHz: ≤ 12 mm	3 – 4 GHz: ≤ 12 mm 4 – 6 GHz: ≤ 10 mm	
		When the x or y dimension of the test device, in the measurement plane orientation, is smaller than the above, the measurement resolution must be \leq the corresponding x or y dimension of the test device with at least one measurement point on the test device.		
Maximum zoom scan spatial resolution: Δx_{Zoom} , Δy_{Zoom}		≤ 2 GHz: ≤ 8 mm 2 – 3 GHz: ≤ 5 mm*	3 – 4 GHz: ≤ 5 mm* 4 – 6 GHz: ≤ 4 mm*	
Maximum zoom scan spatial resolution, normal to phantom surface	uniform grid: $\Delta z_{Zoom}(n)$	≤ 5 mm	3 – 4 GHz: ≤ 4 mm 4 – 5 GHz: ≤ 3 mm 5 – 6 GHz: ≤ 2 mm	
	graded grid	$\Delta z_{Zoom}(1)$: between 1 st two points closest to phantom surface	≤ 4 mm	3 – 4 GHz: ≤ 3 mm 4 – 5 GHz: ≤ 2.5 mm 5 – 6 GHz: ≤ 2 mm
		$\Delta z_{Zoom}(n>1)$: between subsequent points	$\leq 1.5 \cdot \Delta z_{Zoom}(n-1)$ mm	
Minimum zoom scan volume	x, y, z	≥ 30 mm	3 – 4 GHz: ≥ 28 mm 4 – 5 GHz: ≥ 25 mm 5 – 6 GHz: ≥ 22 mm	
Note: δ is the penetration depth of a plane-wave at normal incidence to the tissue medium; see IEEE Std 1528-2013 for details.				
* When zoom scan is required and the <i>reported</i> SAR from the <i>area scan based 1-g SAR estimation</i> procedures of KDB Publication 447498 is ≤ 1.4 W/kg, ≤ 8 mm, ≤ 7 mm and ≤ 5 mm zoom scan resolution may be applied, respectively, for 2 GHz to 3 GHz, 3 GHz to 4 GHz and 4 GHz to 6 GHz.				

Step 4: Power reference measurement (drift)

The Power Drift Measurement job measures the field at the same location as the most recent power reference measurement job within the same procedure, and with the same settings. The indicated drift is mainly the variation of the DUT's output power and should vary max. $\pm 5\%$

Step 5: Z-Scan (FCC only)

The Z scan measures points along a vertical straight line. The line runs along the Z-axis of a one-dimensional grid. In order to get a reasonable extrapolation, the extrapolated distance should not be greater than the step size in Z-direction.

5. DESCRIPTION OF TEST POSITION

5.1. Body-Worn Accessory Configurations

Body-worn operating configurations should be tested with the belt-clips and holsters attached to the device and positioned against a flat phantom in normal use configurations.

Body-worn operating configurations are tested with the belt-clips and holsters attached to the device and positioned against a flat phantom in a normal use configuration. Per FCC KDB Publication 648474 D04, Body-worn accessory exposure is typically related to voice mode operations when handsets are carried in body-worn accessories. The body-worn accessory procedures in FCC KDB Publication 447498 D01 should be used to test for body-worn accessory SAR compliance, without a headset connected to it. This enables the test results for such configuration to be compatible with that required for hotspot mode when the body-worn accessory test separation distance is greater than or equal to that required for hotspot mode, when applicable. When the reported SAR for a body-worn accessory, measured without a headset connected to the handset, is > 1.2 W/kg, the highest reported SAR configuration for that wireless mode and frequency band should be repeated for that body-worn accessory with a headset attached to the handset.

Accessories for Body-worn operation configurations are divided into two categories: those that do not contain metallic components and those that do contain metallic components. When multiple accessories that do not contain metallic components are supplied with the device, the device is tested with only the accessory that dictates the closest spacing to the body. Then multiple accessories that contain metallic components are tested with the device with each accessory. If multiple accessories share an identical metallic component (i.e., the same metallic belt-clip used with different holsters with no other metallic components) only the accessory that dictates the closest spacing to the body is tested.

Body-worn accessories may not always be supplied or available as options for some devices intended to be authorized for body-worn use. In this case, a test configuration with a separation distance between the back of the device and the flat phantom is used. Test position spacing was documented. Transmitters that are designed to operate in front of a person's face, as in push-to-talk configurations, are tested for SAR compliance with the front of the device positioned to face the flat phantom in head fluid. For devices that are carried next to the body such as a shoulder, waist or chest-worn transmitters, SAR compliance is tested with the accessories, including headsets and microphones, attached to the device and positioned against a flat phantom in a normal use configuration.

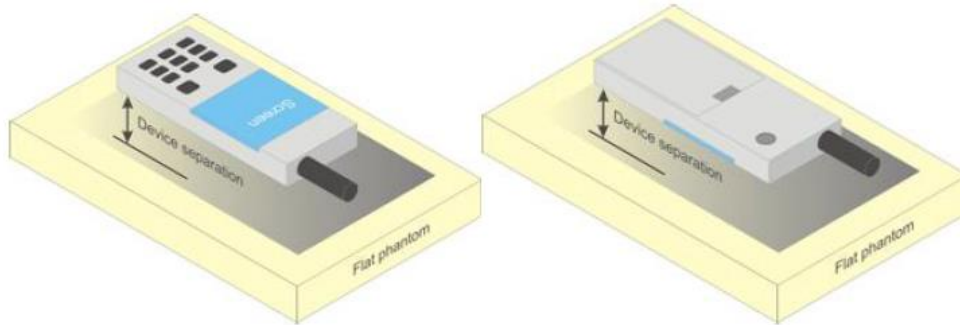

5.2. Extremity exposure configurations

Devices that are designed or intended for use on extremities or mainly operated in extremity only exposure conditions: i.e., hands, wrists, feet and ankles, may require extremity SAR evaluation.

When the device also operates in close proximity to the user's body, SAR compliance for the body is also required. The 1-g body and 10-g extremity SAR Exclusion Thresholds found in KDB Publication 447498 D01v06 should be applied to determine SAR test requirements.

For smart phones with a display diagonal dimension >15.0 cm or an overall diagonal dimension >16.0 cm that provide similar mobile web access and multimedia support found in mini-tablets or UMPC mini-tablets that support voice calls next to the ear. the phablets procedures outlined in KDB Publication 648474 D04 v01r03 should be applied to evaluate SAR compliance. A device marketed as phablets, regardless of form factors and operating characteristics must be tested as a phablet to determine SAR compliance. In addition to the normally required head and body-worm accessory SAR test procedures required for handsets, the UMPC mini-tablet procedures must also be applied to test the SAR of all surfaces and edges with an antenna ≤ 25 mm from that surface or edge, in direct contact with the phantom, for 10-g SAR. The UMPC mini-tablet 1-g SAR at 5 mm is not required. When hotspot mode applies, 10-g SAR is required only for the surfaces and edges with hotspot to the maximum output power (including tolerance) is 1-g SAR >1.2 W/kg.

6. RF EXPOSURE CONDITIONS

6.1. EUT sides and antenna position

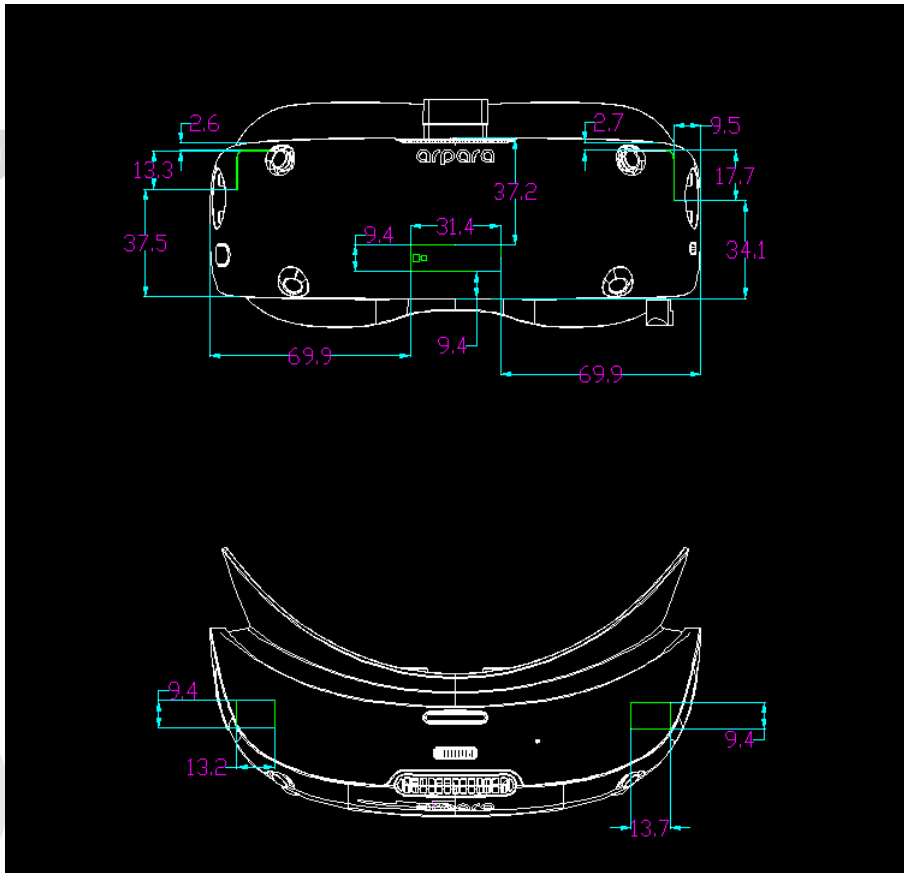

Review

6.2. Standalone SAR Test Exclusion Considerations

According to RSS-102, the SAR test exclusion threshold:

Frequency (MHz)	Exemption Limits (mW)				
	At separation distance of ≤5 mm	At separation distance of 10 mm	At separation distance of 15 mm	At separation distance of 20 mm	At separation distance of 25 mm
≤300	71 mW	101 mW	132 mW	162 mW	193 mW
450	52 mW	70 mW	88 mW	106 mW	123 mW
835	17 mW	30 mW	42 mW	55 mW	67 mW
1900	7 mW	10 mW	18 mW	34 mW	60 mW
2450	4 mW	7 mW	15 mW	30 mW	52 mW
3500	2 mW	6 mW	16 mW	32 mW	55 mW
5800	1 mW	6 mW	15 mW	27 mW	41 mW

Frequency (MHz)	Exemption Limits (mW)				
	At separation distance of 30 mm	At separation distance of 35 mm	At separation distance of 40 mm	At separation distance of 45 mm	At separation distance of ≥50 mm
≤300	223 mW	254 mW	284 mW	315 mW	345 mW
450	141 mW	159 mW	177 mW	195 mW	213 mW
835	80 mW	92 mW	105 mW	117 mW	130 mW
1900	99 mW	153 mW	225 mW	316 mW	431 mW
2450	83 mW	123 mW	173 mW	235 mW	309 mW
3500	86 mW	124 mW	170 mW	225 mW	290 mW
5800	56 mW	71 mW	85 mW	97 mW	106 mW

According to the KDB447498, the SAR test exclusion threshold:

MHz	5	10	15	20	25	mm
150	39	77	116	155	194	SAR Test Exclusion Threshold (mW)
300	27	55	82	110	137	
450	22	45	67	89	112	
835	16	33	49	66	82	
900	16	32	47	63	79	
1500	12	24	37	49	61	
1900	11	22	33	44	54	
2450	10	19	29	38	48	
3600	8	16	24	32	40	
5200	7	13	20	26	33	
5400	6	13	19	26	32	
5800	6	12	19	25	31	
MHz	30	35	40	45	50	
150	232	271	310	349	387	SAR Test Exclusion Threshold (mW)
300	164	192	219	246	274	
450	134	157	179	201	224	
835	98	115	131	148	164	
900	95	111	126	142	158	
1500	73	86	98	110	122	
1900	65	76	87	98	109	
2450	57	67	77	86	96	
3600	47	55	63	71	79	
5200	39	46	53	59	66	
5400	39	45	52	58	65	
5800	37	44	50	56	62	

6.3. Test sides and test exclusion

For 100 MHz to 6 GHz and test separation distances ≤ 50 mm, the 1-g and 10-g SAR test exclusion thresholds are determined by the following:

$[(\text{max. power of channel, including tune-up tolerance, mW}) / (\text{min. test separation distance, mm})] \cdot [\sqrt{f(\text{GHz})}] \leq 3.0$ for 1-g SAR and ≤ 7.5 for 10-g SAR, where $f(\text{GHz})$ is the RF channel transmit frequency in GHz

Power and distance are rounded to the nearest mW and mm before calculation

The result is rounded to one decimal place for comparison

For 100 MHz to 6 GHz and test separation distances > 50 mm, the 1-g and 10-g SAR test exclusion thresholds are determined by the following:

- 1) $\{[\text{Power allowed at numeric threshold for 50 mm in above step}]\} + \{[(\text{test separation distance} - 50 \text{ mm}) \cdot (f(\text{MHz})/150)]\}$ mW, for 100 MHz to 1500 MHz
- 2) $\{[\text{Power allowed at numeric threshold for 50 mm in above step}]\} + \{[(\text{test separation distance} - 50 \text{ mm}) \cdot 10]\}$ mW, for > 1500 MHz and ≤ 6 GHz

Antenna1

BT 1-g SAR test exclusion ≤ 50 mm							
Position	Frequency (MHz)	Power (dBm)	Power (mW)	Separation Distance (mm)	Calculated Result	Threshold	SAR Test
Top	2480	11.5	14.13	37.2	0.60	3	Exclusion

BT 10-g SAR test exclusion ≤ 50 mm							
Position	Frequency (MHz)	Power (dBm)	Power (mW)	Separation Distance (mm)	Calculated Result	Threshold	SAR Test
Top	2480	11.5	14.13	37.2	0.60	7.5	Exclusion

BT 1-g SAR test exclusion > 50 mm							
Position	Frequency (MHz)	Power (dBm)	Power (mW)	Separation Distance (mm)	Calculated Result (mW)	SAR Test	
Left & Right	2480	11.5	14.13	69.9	294.25	Exclusion	

BT 10-g SAR test exclusion > 50 mm							
Position	Frequency (MHz)	Power (dBm)	Power (mW)	Separation Distance (mm)	Calculated Result (mW)	SAR Test	
Left & Right	2480	11.5	14.13	69.9	437.13	Exclusion	

WIFI_2.4G 1-g SAR test exclusion ≤ 50 mm							
Position	Frequency (MHz)	Power (dBm)	Power (mW)	Separation Distance	Calculated Result	Threshold	SAR Test

				(mm)			
Top	2462	13	19.95	37.2	0.84	3	Exclusion

WIFI_2.4G 10-g SAR test exclusion \leq 50mm							
Position	Frequency (MHz)	Power (dBm)	Power (mW)	Separation Distance (mm)	Calculated Result	Threshold	SAR Test
Top	2462	13	19.95	37.2	0.84	7.5	Exclusion

WIFI_2.4G 1-g SAR test exclusion $>$ 50mm							
Position	Frequency (MHz)	Power (dBm)	Power (mW)	Separation Distance (mm)	Calculated Result (mW)		SAR Test
Left & Right	2462	13	19.95	69.9	294.60		Exclusion

WIFI_2.4G 10-g SAR test exclusion $>$ 50mm							
Position	Frequency (MHz)	Power (dBm)	Power (mW)	Separation Distance (mm)	Calculated Result (mW)		SAR Test
Left & Right	2462	13	19.95	69.9	437.99		Exclusion

WIFI_5G 1-g SAR test exclusion \leq 50mm							
Position	Frequency (MHz)	Power (dBm)	Power (mW)	Separation Distance (mm)	Calculated Result	Threshold	SAR Test
Top	5825	12.5	17.78	37.2	1.15	3	Exclusion

WIFI_5G 10-g SAR test exclusion \leq 50mm							
Position	Frequency (MHz)	Power (dBm)	Power (mW)	Separation Distance (mm)	Calculated Result	Threshold	SAR Test
Top	5825	12.5	17.78	37.2	1.15	7.5	Exclusion

WIFI_5G 1-g SAR test exclusion $>$ 50mm							
Position	Frequency (MHz)	Power (dBm)	Power (mW)	Separation Distance (mm)	Calculated Result (mW)		SAR Test
Left & Right	5825	12.5	17.78	69.9	261.15		Exclusion

WIFI_5G 10-g SAR test exclusion $>$ 50mm							
Position	Frequency (MHz)	Power (dBm)	Power (mW)	Separation Distance (mm)	Calculated Result (mW)		SAR Test
Left & Right	5825	12.5	17.78	69.9	354.38		Exclusion

Antenna2

WIFI_2.4G 1-g SAR test exclusion \leq 50mm							
Position	Frequency (MHz)	Power (dBm)	Power (mW)	Separation Distance (mm)	Calculated Result	Threshold	SAR Test
Bottom	2462	14	25.12	37.5	1.05	3	Exclusion

WIFI_2.4G 10-g SAR test exclusion \leq 50mm							
Position	Frequency (MHz)	Power (dBm)	Power (mW)	Separation Distance (mm)	Calculated Result	Threshold	SAR Test
Bottom	2462	14	25.12	37.5	1.05	7.5	Exclusion

WIFI_2.4G 1-g SAR test exclusion $>$ 50mm							
Position	Frequency (MHz)	Power (dBm)	Power (mW)	Separation Distance (mm)	Calculated Result (mW)	SAR Test	
Right	2462	14	25.12	158	1175.60	Exclusion	

WIFI_2.4G 10-g SAR test exclusion $>$ 50mm							
Position	Frequency (MHz)	Power (dBm)	Power (mW)	Separation Distance (mm)	Calculated Result (mW)	SAR Test	
Right	2462	14	25.12	158	1318.99	Exclusion	

WIFI_5G 1-g SAR test exclusion \leq 50mm							
Position	Frequency (MHz)	Power (dBm)	Power (mW)	Separation Distance (mm)	Calculated Result	Threshold	SAR Test
Bottom	5825	12	15.85	37.5	1.02	3	Exclusion

WIFI_5G 10-g SAR test exclusion \leq 50mm							
Position	Frequency (MHz)	Power (dBm)	Power (mW)	Separation Distance (mm)	Calculated Result	Threshold	SAR Test
Bottom	5825	12	15.85	37.5	1.02	7.5	Exclusion

WIFI_5G 1-g SAR test exclusion $>$ 50mm							
Position	Frequency (MHz)	Power (dBm)	Power (mW)	Separation Distance (mm)	Calculated Result (mW)	SAR Test	
Left & Right	5825	12	15.85	158	1142.15	Exclusion	

WIFI_5G 10-g SAR test exclusion $>$ 50mm							
Position	Frequency (MHz)	Power (dBm)	Power (mW)	Separation Distance (mm)	Calculated Result (mW)	SAR Test	
Left & Right	5825	12	15.85	158	1235.38	Exclusion	

SAR test sides								
Antenna	Band	Head & Extremities						
		Front	Back	Top	Bottom	Left	Right	Slope
ANT1	BT	√	√	×	√	×	×	×
ANT1	WIFI_2.4G	√	√	×	√	×	×	×
ANT1	WIFI_5G	√	√	×	√	×	×	×
ANT2	WIFI_2.4G	×	√	√	×	×	×	√
ANT2	WIFI_5G	×	√	√	×	×	×	√

Note: The Head SAR test distance is 0mm between EUT outer surface with the phantom.

7. SAR SYSTEM VERIFICATION PROCEDURE

7.1. Tissue Simulate Liquid

7.1.1. Target dielectric properties of head tissue-equivalent material

Frequency (MHz)	Relative permittivity (ϵ_r)	Conductivity (σ) (S/m)
300	45.3	0.87
450	43.5	0.87
750	41.9	0.89
835	41.5	0.90
900	41.5	0.97
1450	40.5	1.20
1500	40.4	1.23
1640	40.2	1.31
1750	40.1	1.37
1800	40.0	1.40
1900	40.0	1.40
2000	40.0	1.40
2100	39.8	1.49
2300	39.5	1.67
2450	39.2	1.80
2600	39.0	1.96
3000	38.5	2.40
3500	37.9	2.91
4000	37.4	3.43
4500	36.8	3.94
5000	36.2	4.45
5200	36.0	4.66
5400	35.8	4.86
5600	35.5	5.07
5800	35.3	5.27
6000	35.1	5.48

NOTE—For convenience, permittivity and conductivity values at some frequencies that are not part of the original data from Drossos et al. [B60] or the extension to 5800 MHz are provided (i.e., the values shown in italics). These values were linearly interpolated between the values in this table that are immediately above and below these values, except the values at 6000 MHz that were linearly extrapolated from the values at 3000 MHz and 5800 MHz.

7.1.2. Measurement for Tissue Simulate Liquid

The dielectric properties for this Tissue Simulate Liquids were measured by using the Agilent Model 85070E Dielectric Probe in conjunction with Agilent E5071C Network Analyzer (300 KHz-8500 MHz). The Conductivity (σ) and Permittivity (ρ) are listed in table. For the SAR measurement given in this report. The temperature variation of the Tissue Simulate Liquids was $22\pm 2^\circ\text{C}$.

Tissue Type	Freq. (MHz)	Target Tissue ($\pm 5\%$)		Measured Tissue		Liquid Temp. ($^\circ\text{C}$)	Measured Date
		ϵ_r	$\sigma(\text{S/m})$	ϵ_r	$\sigma(\text{S/m})$		
2450 head	2360	39.38 (37.411~41.349)	1.722 (1.6359~1.8081)	37.51	1.681	20.8	2022/08/29
	2450	39.20 (37.240~41.160)	1.80 (1.710~1.890)	37.28	1.762	20.8	2022/08/29
	2540	39.02 (37.069~40.971)	1.878 (1.7841~1.9719)	37.01	1.851	20.8	2022/08/29
5300 head	5160	36.04 (34.238~37.842)	4.618 (4.3871~4.8489)	37.14	4.413	20.8	2022/08/30
	5200	36.00 (34.2~37.8)	4.66 (4.427~4.893)	36.96	4.487	20.8	2022/08/30

	5300	35.95 (34.1525~37.7475)	4.71 (4.4745~4.9455)	36.70	4.628	20.8	2022/08/30
	5340	35.86 (34.067~37.653)	4.80 (4.56~5.04)	36.49	4.653	20.8	2022/08/30
5500 head	5500	35.65 (33.8675~37.4325)	4.965 (4.7168~5.2133)	35.94	4.822	20.8	2022/08/31
5600 head	5600	35.5 (33.725~37.275)	5.07 (4.8165~5.3235)	35.75	4.92	20.8	2022/08/31
	5690	35.41 (33.6395~37.1805)	5.16 (4.902~5.418)	35.48	5.01	20.8	2022/08/31
5800 head	5660	35.44 (33.668~37.212)	5.13 (4.8735~5.3865)	35.57	4.979	20.8	2022/08/31
	5750	35.35 (33.5825~37.1175)	5.22 (4.959~5.481)	35.33	5.069	20.8	2022/08/31
	5800	35.3 (33.535~37.065)	5.27 (5.0065~5.5335)	35.31	5.121	20.8	2022/08/31
	5840	35.26 (33.497~37.023)	5.312 (5.0464~5.5776)	35.15	5.16	20.8	2022/08/31

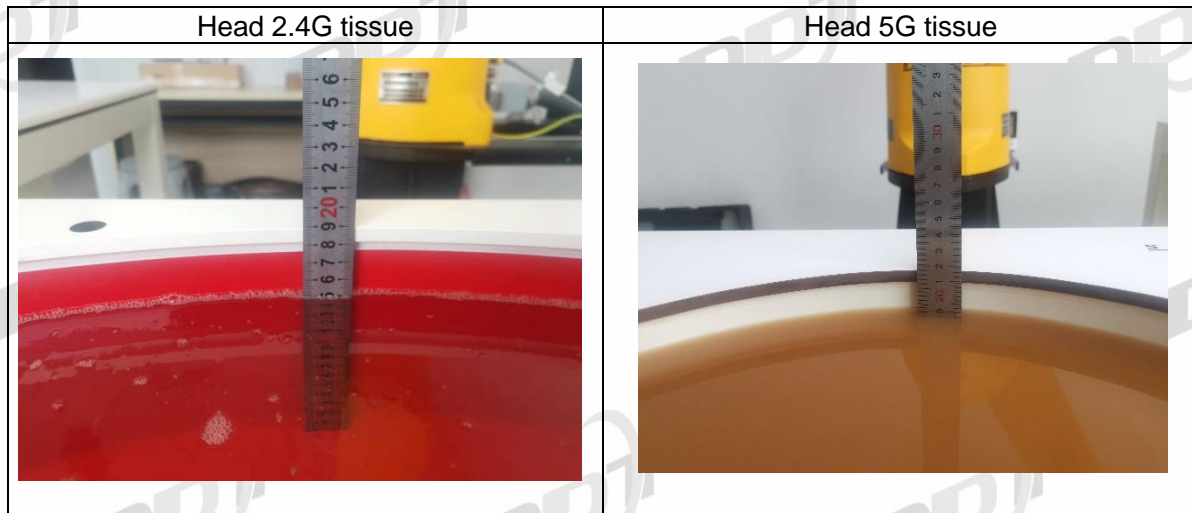

7.2. SAR System Validation

The microwave circuit arrangement for system verification is sketched in bellow figure. The daily system accuracy verification occurs within the flat section of the SAM phantom. A SAR measurement was performed to see if the measured SAR was within +/- 10% from the target SAR values. The tests were conducted on the same days as the measurement of the EUT. The obtained results from the system accuracy verification are displayed in the table 5 (A power level of 250mw was input to the dipole antenna). During the tests, the ambient temperature of the laboratory was in the range $22\pm 2^{\circ}\text{C}$, the relative humidity was in the range 60% and the liquid depth above the ear reference points was above 15 cm in all the cases. It is seen that the system is operating within its specification, as the results are within acceptable tolerance of the reference values.

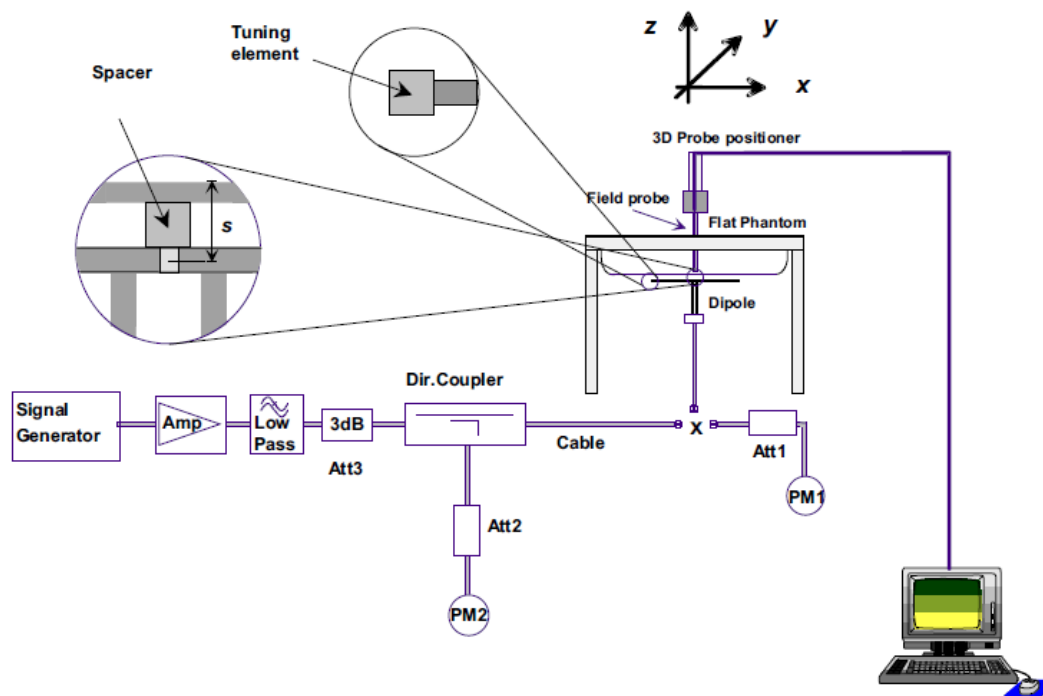

7.2.1. Justification for Extended SAR Dipole Calibrations

1) Referring to KDB865664 D01 requirements for dipole calibration, instead of the typical annual calibration recommended by measurement standards, longer calibration intervals of up to three years may be considered when it is demonstrated that the SAR target, impedance and return loss of a dipole have remain stable according to the following requirements. Each measured dipole is expected to evaluate with the following criteria at least on annual interval in Appendix C.

- a) There is no physical damage on the dipole;
- b) System check with specific dipole is within 10% of calibrated value;
- c) Return-loss is within 10% of calibrated measurement;

d) Impedance is within 5Ω from the previous measurement.

2) Network analyzer probe calibration against air, distilled water and a shorting block performed before measuring liquid parameters.

7.2.2. Validation Test Setup Photograph

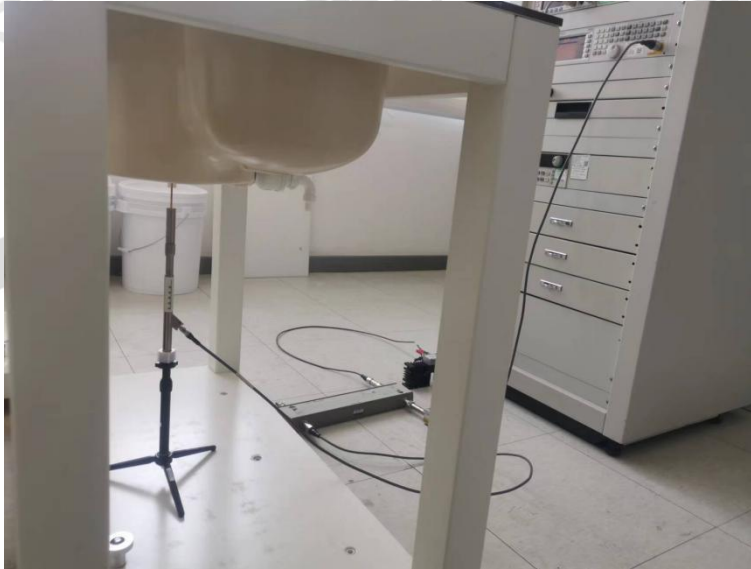

7.2.3. Summary System Validation Results

Validation Kit		Measured SAR 250mW (W/kg)	Measured SAR normalized to 1w (W/kg)	Target SAR (normalized to 1w ($\pm 10\%$) (W/kg)	Liquid Temp. ($^{\circ}\text{C}$)	Measured Date
D2450V2 @2450MHz	1-g	12.9	51.60	53.1 (47.79~58.41)	20.8	2022/08/29
	10-g	6.06	24.24	24.5 (22.05~26.95)		

Validation Kit		Measured SAR 100mW (W/kg)	Measured SAR normalized to 1w (W/kg)	Target SAR (normalized to 1w ($\pm 10\%$) (W/kg)	Liquid Temp. ($^{\circ}\text{C}$)	Measured Date
D5GHzV2 @5200MHz	1-g	7.73	77.3	75.6 (68.04~83.16)	20.8	2022/08/30
	10-g	2.14	21.4	21.2 (19.08~23.32)		
D5GHzV2 @5300MHz	1-g	8.01	80.1	78.4 (70.56~86.24)	20.8	2022/08/30
	10-g	2.17	21.7	22.1 (19.89~24.31)		

D5GHzV2 @5500MHz	1-g	8.26	82.6	83.2 (74.88~91.52)	20.8	2022/08/31
	10-g	2.23	22.3	23.3 (20.97~25.63)		
D5GHzV2 @5600MHz	1-g	7.97	79.7	80.8 (72.72~88.88)	20.8	2022/08/31
	10-g	2.12	21.2	22.6 (20.34~24.86)		
D5GHzV2 @5800MHz	1-g	7.76	77.6	76.9 (69.21~84.59)	20.8	2022/08/31
	10-g	2.05	20.5	21.3 (19.17~23.43)		

7.2.4. Detailed System Validation Results

See the Appendix A.

8. EQUIPMENT LIST

Test Platform	SPEAG DASY5 Professional				
Location	SAR room				
Description	SAR Test System (Frequency range 300MHz-6GHz)				
Equipment	Manufacturer	Model	Serial Number	Calibration Date	Due date of calibration
Robot	Staubli	TX90 XL	F12/5N3XC/A/01	NCR	NCR
SAM twin Phantom	SPEAG	SAM	1752	NCR	NCR
DAE	SPEAG	DAE4	1366	2022-01-21	2023-01-20
SAR test Probe	SPEAG	EX3DV4	3906	2022-02-27	2023-02-26
Validation Kits	SPEAG	D2450V2	904	2022-01-26	2025-01-25
Validation Kits	SPEAG	D5GHzV2	1148	2022-01-26	2025-01-25
Agilent Network Analyzer	Agilent	E5071C	MY46316792	2022-02-16	2023-02-15
Dielectric Probe Kit	Agilent	85070E	85070-20037	NCR	NCR
0.1G-2Ghz DUAL DIRECTIONAL COUPLER	Agilent	778D	MY52180233	NCR	NCR
2G-18Ghz DUAL DIRECTIONAL COUPLER	Agilent	772D	MY52180116	NCR	NCR
Signal Generator	Agilent	N5182A	MY50143288	2022-03-07	2023-03-06
Preamplifier	Mini-Circuits	ZHL-42W	QA1240001	NCR	NCR
Preamplifier	Mini-Circuits	ZVE-8G+	926701231	NCR	NCR
EPM Series Power Meter	Agilent	N1914A	MY53040013	2022-02-16	2023-02-15
Power Sensor	Agilent	8481H	MY52490005	2022-02-16	2023-02-15
Attenuator	Agilent	8491A 3dB	MY52460179	NCR	NCR
Attenuator	Agilent	8491A 10dB	MY52460275	NCR	NCR
Humidity and Temperature Indicator	Anymetre	JR900	#4	2022-02-09	2023-02-08

9. MEASUREMENT UNCERTAINTY

Uncertainty Component	probability distribution	Contains the factor	Standard uncertainty U_i	C1(1g)	C1(10g)
Sensitivity of probe	N	1	±6.55%	1	1
Isotropy of the probe	R	$\sqrt{3}$	±1.08%	1	1
Linearity of the probe	R	$\sqrt{3}$	±0.35%	1	1
Coupling effect between probe and dielectric boundary	R	$\sqrt{3}$	±0.46%	1	1
The detection limit of the system	R	$\sqrt{3}$	±0.14%	1	1
Errors in electronic reading equipment	N	1	±0.35%	1	1
Measure the response time of the equipment	R	$\sqrt{3}$	0	1	1
Measure the integral time of the equipment	R	$\sqrt{3}$	±1.50%	1	1
Data post-processing algorithm	R	$\sqrt{3}$	±0.58%	1	1
Electromagnetic environment disturbance	R	$\sqrt{3}$	±1.73%	1	1
the positioning accuracy of the probe	R	$\sqrt{3}$	±0.87%	1	1
The positioning accuracy of the probe tip relative to the model surface	R	$\sqrt{3}$	±1.67%	1	1
Manufacturing tolerances for models	R	$\sqrt{3}$	±2.31%	1	1
Deviation of measured liquid conductivity from target value	R	$\sqrt{3}$	±2.89%	0.64	0.43
Liquid conductivity test system accuracy	N	1	±2.5%	0.64	0.43
The deviation between the measured permittivity of liquid and the target value	R	$\sqrt{3}$	±2.89%	0.6	0.49
Test precision of liquid permittivity test system	N	1	±2.5%	0.6	0.49
The disturbance of the positioning fixture	N	1	±5.2%	1	1
Accuracy of sample positioning	N	1	±4.6%	1	1
The output power of the tested sample drifts	R	$\sqrt{3}$	±2.89%	1	1
Combined standard uncertainty	Uc(1g)=11.3%, Uc(10g)=11.0%				
Expanded uncertainty (95% confidence interval) k=2	U(1g)=22.6%, U(10g)=22%				

10. TEST RESULTS AND MEASUREMENT DATA

10.1. RF conducted Power

Antenna1 conducted Power

Bluetooth BR/EDR					
Average conducted power					
Mode	Channel	Frequency (MHz)	Power (dBm)	Duty-Cycle	Max. Tune-up Power (dBm)
DH5	0	2402	9.58	0.7707	11.5
	39	2441	11.35	0.7707	11.5
	78	2480	9.92	0.7707	11.5
2DH5	0	2402	8.79	0.7713	10.5
	39	2441	10.44	0.7713	11.5
	78	2480	8.78	0.7713	10.5
3DH5	0	2402	9.77	0.7713	11.5
	39	2441	10.89	0.7713	11.5
	78	2480	9.65	0.7713	11.5

Bluetooth BLE					
Average conducted power					
Mode	Channel	Frequency (MHz)	Power (dBm)	Duty-Cycle	Max. Tune-up Power (dBm)
BLE-1Mbps	0	2402	2.88	0.619	4
	19	2440	4.97	0.6349	5
	39	2480	2.56	0.619	4

Note:

- 1.The output power of the device was set to transmit at maximum power for all test.
- 2.The Bluetooth maximum output power mode is DH5, select DH5 mode to test SAR.

WIFI_2.4G						
Average conducted power						
Mode	Channel	Frequency (MHz)	Data Rate	Power (dBm)	Duty-Cycle	Max. Tune-up Power (dBm)
802.11b	1	2412	1Mbps	12.66	0.971	13
	6	2437		11.65	0.971	13
	11	2462		12.52	0.9695	13
802.11g	1	2412	6Mbps	12.87	0.7299	13
	6	2437		11.9	0.7299	13
	11	2462		12.35	0.7299	13
802.11n-HT20	1	2412	MCS0	12.59	0.9362	13
	6	2437		11.66	0.9362	13
	11	2462		12.25	0.9362	13
802.11n-HT40	3	2422	MCS0	12.26	0.9346	13
	6	2437		12.27	0.9362	13
	9	2452		12.43	0.933	13
802.11ax-HT20	1	2412	MCS0	12.65	0.9349	13
	6	2437		12.06	0.9381	13
	11	2462		12.27	0.9365	13

802.11ax-HT40	3	2422	MCS0	12.45	0.935	13
	6	2437		12.52	0.9334	13
	9	2452		12.65	0.9366	13

Note:

1.The output power of the device was set to transmit at maximum power for all test.

WIFI_5G_U-NII-1						
Average conducted power						
Mode	Channel	Frequency (MHz)	Data Rate	Power (dBm)	Duty-Cycle	Max. Tune-up Power (dBm)
802.11a	36	5180	6Mbps	11.14	0.9804	12.5
	40	5200		11.11	0.9804	12.5
	48	5240		11.24	0.9804	12.5
802.11n-HT20 802.11ac-HT20	36	5180	MCS0	10.97	0.938	12.5
	40	5200		10.9	0.9963	12.5
	48	5240		11.11	0.9364	12.5
802.11n-HT40 802.11ac-HT40	38	5190	MCS0	11.06	0.9347	12.5
	46	5230		11.14	0.9143	12.5
802.11ax-HT20	36	5180	MCS0	10.91	0.9381	12.5
	40	5200		10.88	0.9381	12.5
	48	5240		10.97	0.9381	12.5
802.11ax-HT40	38	5190	MCS0	11.1	0.9383	12.5
	46	5230		11.15	0.935	12.5
802.11ax-HT80	42	5210	MCS0	10.92	0.9446	12.5

Note:

1.The output power of the device was set to transmit at maximum power for all test.

WIFI_5G_U-NII-2A						
Average conducted power						
Mode	Channel	Frequency (MHz)	Data Rate	Power (dBm)	Duty-Cycle	Max. Tune-up Power (dBm)
802.11a	52	5260	6Mbps	11.3	0.9902	12.5
	56	5280		11.71	0.9902	12.5
	64	5320		12.22	0.9902	12.5
802.11n-HT20 802.11ac-HT20	52	5260	MCS0	11.22	0.9963	12.5
	56	5280		11.59	0.9158	12.5
	64	5320		12.1	0.9963	12.5
802.11n-HT40 802.11ac-HT40	54	5270	MCS0	11.45	0.9347	12.5
	62	5310		12.15	0.9347	12.5
802.11ax-HT20	52	5260	MCS0	11.09	0.9317	12.5
	56	5280		11.42	0.9333	12.5
	64	5320		12.04	0.9381	12.5
802.11ax-HT40	54	5270	MCS0	11.57	0.935	12.5
	62	5310		12.22	0.924	12.5
802.11ax-HT80	58	5290	MCS0	11.53	0.9479	12.5

Note:

1.The output power of the device was set to transmit at maximum power for all test.

WIFI_5G_U-NII-2C						
Average conducted power						
Mode	Channel	Frequency (MHz)	Data Rate	Power (dBm)	Duty-Cycle	Max. Tune-up Power (dBm)
802.11a	100	5500	6Mbps	11.05	0.9901	12.5
	116	5580		10.93	0.9804	12.5
	140	5700		12.23	0.9804	12.5
802.11n-HT20 802.11ac-HT20	100	5500	MCS0	10.87	0.9379	12.5
	116	5580		10.75	0.9963	12.5
	140	5700		12.12	0.9963	12.5
802.11n-HT40 802.11ac-HT40	102	5510	MCS0	10.97	0.9128	12.5
	110	5550		10.98	0.9347	12.5
	134	5670		12.13	0.9363	12.5
802.11ax-HT20	100	5500	MCS0	10.83	0.9349	12.5
	116	5580		10.73	0.9381	12.5
	140	5700		12.04	0.9365	12.5
802.11ax-HT40	102	5510	MCS0	11.01	0.935	12.5
	110	5550		11.02	0.9319	12.5
	134	5670		12.15	0.9349	12.5
802.11ax-HT80	106	5530	MCS0	10.73	0.9479	12.5
	122	5610		11.12	0.9286	12.5

Note:

1.The output power of the device was set to transmit at maximum power for all test.

WIFI_5G_U-NII-3						
Average conducted power						
Mode	Channel	Frequency (MHz)	Data Rate	Power (dBm)	Duty-Cycle	Max. Tune-up Power (dBm)
802.11a	149	5745	6Mbps	12.25	0.9804	12.5
	157	5785		12.02	0.9804	12.5
	165	5825		11.06	0.9901	12.5
802.11n-HT20 802.11ac-HT20	149	5745	MCS0	12.22	0.9331	12.5
	157	5785		11.88	0.9379	12.5
	165	5825		10.93	0.9347	12.5
802.11n-HT40 802.11ac-HT40	151	5755	MCS0	12.34	0.9331	12.5
	159	5795		11.8	0.9347	12.5
802.11ax-HT20	149	5745	MCS0	12.08	0.9365	12.5
	157	5785		11.8	0.9365	12.5
	165	5825		10.88	0.9365	12.5
802.11ax-HT40	151	5755	MCS0	12.46	0.9383	12.5
	159	5795		11.94	0.924	12.5
802.11ax-HT80	155	5775	MCS0	11.97	0.9479	12.5

Note:

1.The output power of the device was set to transmit at maximum power for all test.

Antenna2 conducted Power

WIFI_2.4G						
Average conducted power						
Mode	Channel	Frequency (MHz)	Data Rate	Power (dBm)	Duty-Cycle	Max. Tune-up Power (dBm)
802.11b	1	2412	1Mbps	13.54	0.9688	14
	6	2437		12.89	0.9703	14
	11	2462		12.96	0.9703	14
802.11g	1	2412	6Mbps	12.12	0.7299	13
	6	2437		11.53	0.7194	13
	11	2462		12.4	0.7299	13
802.11n-HT20	1	2412	MCS0	12.1	0.9346	13
	6	2437		11.8	0.9346	13
	11	2462		12.13	0.9362	13
802.11n-HT40	3	2422	MCS0	12.19	0.933	13
	6	2437		11.88	0.9346	13
	9	2452		12.52	0.9188	13
802.11ax-HT20	1	2412	MCS0	12.3	0.9349	14
	6	2437		12.18	0.9365	14
	11	2462		12.46	0.9302	14
802.11ax-HT40	3	2422	MCS0	12.35	0.9193	14
	6	2437		12.17	0.935	14
	9	2452		13.01	0.9286	14

Note:

1.The output power of the device was set to transmit at maximum power for all test.

WIFI_5G_U-NII-1						
Average conducted power						
Mode	Channel	Frequency (MHz)	Data Rate	Power (dBm)	Duty-Cycle	Max. Tune-up Power (dBm)
802.11a	36	5180	6Mbps	10.89	0.9804	12
	40	5200		11.03	0.9804	12
	48	5240		10.69	0.9902	12
802.11n-HT20 802.11ac-HT20	36	5180	MCS0	10.66	0.9332	12
	40	5200		10.75	0.9364	12
	48	5240		10.46	0.9363	12
802.11n-HT40 802.11ac-HT40	38	5190	MCS0	10.95	0.9347	12
	46	5230		11.02	0.9347	12
802.11ax-HT20	36	5180	MCS0	10.79	0.9365	12
	40	5200		10.84	0.9333	12
	48	5240		10.54	0.9365	12
802.11ax-HT40	38	5190	MCS0	11.13	0.9162	12
	46	5230		11.33	0.935	12
802.11ax-HT80	42	5210	MCS0	10.96	0.9479	12

Note:

1.The output power of the device was set to transmit at maximum power for all test.

WIFI_5G_U-NII-2A						
Average conducted power						
Mode	Channel	Frequency (MHz)	Data Rate	Power (dBm)	Duty-Cycle	Max. Tune-up Power (dBm)
802.11a	52	5260	6Mbps	10.58	0.9902	12
	56	5280		10.47	0.9804	12
	64	5320		10.8	0.9804	12
802.11n-HT20 802.11ac-HT20	52	5260	MCS0	10.39	0.9331	12
	56	5280		10.24	0.9379	12
	64	5320		10.59	0.9348	12
802.11n-HT40 802.11ac-HT40	54	5270	MCS0	10.74	0.9174	12
	62	5310		11.04	0.9347	12
802.11ax-HT20	52	5260	MCS0	10.46	0.9349	12
	56	5280		10.3	0.9161	12
	64	5320		10.61	0.9398	12
802.11ax-HT40	54	5270	MCS0	10.79	0.9366	12
	62	5310		11.16	0.9349	12
802.11ax-HT80	58	5290	MCS0	10.67	0.9479	12

Note:

1. The output power of the device was set to transmit at maximum power for all test.

WIFI_5G_U-NII-2C						
Average conducted power						
Mode	Channel	Frequency (MHz)	Data Rate	Power (dBm)	Duty-Cycle	Max. Tune-up Power (dBm)
802.11a	100	5500	6Mbps	11.39	0.9902	12
	116	5580		10.92	0.9902	12
	140	5700		10.94	0.9804	12
802.11n-HT20 802.11ac-HT20	100	5500	MCS0	11.27	0.9363	12
	116	5580		10.84	0.9363	12
	140	5700		10.83	0.9363	12
802.11n-HT40 802.11ac-HT40	102	5510	MCS0	11.41	0.9332	12
	110	5550		11.36	0.9347	12
	134	5670		11.03	0.9347	12
802.11ax-HT20	100	5500	MCS0	11.28	0.9381	12
	116	5580		10.75	0.9365	12
	140	5700		11.03	0.9365	12
802.11ax-HT40	102	5510	MCS0	11.26	0.935	12
	110	5550		11.6	0.9366	12
	134	5670		11.48	0.9365	12
802.11ax-HT80	106	5530	MCS0	11.21	0.9463	12
	122	5610		10.4	0.9479	12

Note:

1. The output power of the device was set to transmit at maximum power for all test.

WIFI_5G_U-NII-3						
Average conducted power						
Mode	Channel	Frequency (MHz)	Data Rate	Power (dBm)	Duty-Cycle	Max. Tune-up Power (dBm)
802.11a	149	5745	6Mbps	10.85	0.9804	11.5
	157	5785		10.95	0.9804	11.5
	165	5825		10.06	0.9804	11.5
802.11n-HT20 802.11ac-HT20	149	5745	MCS0	10.75	0.938	11.5
	157	5785		10.91	0.9332	11.5
	165	5825		9.98	0.9222	11.5
802.11n-HT40 802.11ac-HT40	151	5755	MCS0	11.09	0.9364	11.5
	159	5795		11.02	0.9299	11.5
802.11ax-HT20	149	5745	MCS0	10.66	0.9333	11.5
	157	5785		11.4	0.9365	11.5
	165	5825		9.9	0.9381	11.5
802.11ax-HT40	151	5755	MCS0	11.51	0.9162	12
	159	5795		11.59	0.9366	12
802.11ax-HT80	155	5775	MCS0	11.07	0.9463	12

Note:

1. The output power of the device was set to transmit at maximum power for all test.

10.2. Measurement of Head SAR Data

Antenna1 Result

Bluetooth Head 0mm SAR 1-g											
Test position	Test mode	Test Ch./Freq (MHz)	Duty Cycle	SAR 1-g (W/kg)	Power drift (dB)	Conduct power (dBm)	Max. Tune-up Power (dBm)	Scaled factor	Scaled SAR 1-g (W/kg)	Liquid Temp. (°C)	SAR limit 1-g (W/kg)
Front	DH5	39/2441	0.7707	0.0409	-0.15	11.35	11.5	1.3431	0.0549	20.8	1.6
Back	DH5	39/2441	0.7707	0.0082	-0.19	11.35	11.5	1.3431	0.0110	20.8	1.6
Bottom	DH5	39/2441	0.7707	0.12	-0.09	11.35	11.5	1.3431	0.1612	20.8	1.6

WIFI_2.4G Head 0mm SAR 1g											
Test position	Test mode	Test Ch./Freq (MHz)	Duty Cycle	SAR 1-g (W/kg)	Power drift (dB)	Conduct power (dBm)	Max. Tune-up Power (dBm)	Scaled factor	Scaled SAR 1-g (W/kg)	Liquid Temp. (°C)	SAR limit 1-g (W/kg)
Front	802.11b	1/2412	0.971	0.587	-0.17	12.66	13	1.1137	0.6537	20.8	1.6
Back	802.11b	1/2412	0.971	0.00935	-0.09	12.66	13	1.1137	0.0104	20.8	1.6
Bottom	802.11b	1/2412	0.971	1.03	-0.13	12.66	13	1.1137	1.1471	20.8	1.6

WIFI_5G_ U-NII-1 Head 0mm SAR 1-g											
Test position	Test mode	Test Ch./Freq (MHz)	Duty Cycle	SAR 1-g (W/kg)	Power drift (dB)	Conduct power (dBm)	Max. Tune-up Power (dBm)	Scaled factor	Scaled SAR 1-g (W/kg)	Liquid Temp. (°C)	SAR limit 1-g (W/kg)
Front	802.11a	48/5240	0.9804	0.382	0.13	11.24	12.5	1.3633	0.5208	20.8	1.6
Back	802.11a	48/5240	0.9804	0.00912	-0.16	11.24	12.5	1.3633	0.0124	20.8	1.6
Bottom	802.11a	48/5240	0.9804	0.783	0.12	11.24	12.5	1.3633	1.0675	20.8	1.6

WIFI_5G_ U-NII-2A Head 0mm SAR 1-g											
Test position	Test mode	Test Ch./Freq (MHz)	Duty Cycle	SAR 1-g (W/kg)	Power drift (dB)	Conduct power (dBm)	Max. Tune-up Power (dBm)	Scaled factor	Scaled SAR 1-g (W/kg)	Liquid Temp. (°C)	SAR limit 1-g (W/kg)
Front	802.11ax HT40	62/5310	0.924	0.492	0.13	12.22	12.5	1.1543	0.5679	20.8	1.6
Back	802.11ax HT40	62/5310	0.924	0.00813	-0.18	12.22	12.5	1.1543	0.0094	20.8	1.6
Bottom	802.11ax HT40	62/5310	0.924	0.817	0.15	12.22	12.5	1.1543	0.9431	20.8	1.6

WIFI_5G_ U-NII-2C Head 0mm SAR 1-g											
Test position	Test mode	Test Ch./Freq (MHz)	Duty Cycle	SAR 1-g (W/kg)	Power drift (dB)	Conduct power (dBm)	Max. Tune-up Power (dBm)	Scaled factor	Scaled SAR 1-g (W/kg)	Liquid Temp. (°C)	SAR limit 1-g (W/kg)
Front	802.11a	140/5700	0.9804	0.484	0.08	12.23	12.5	1.0854	0.5253	20.8	1.6
Back	802.11a	140/5700	0.9804	0.00935	-0.16	12.23	12.5	1.0854	0.0101	20.8	1.6
Bottom	802.11a	140/5700	0.9804	0.847	0.02	12.23	12.5	1.0854	0.9193	20.8	1.6

WIFI_5G_ U-NII-3 Head 0mm SAR 1-g											
Test position	Test mode	Test Ch./Freq (MHz)	Duty Cycle	SAR 1-g (W/kg)	Power drift (dB)	Conduct power (dBm)	Max. Tune-up Power (dBm)	Scaled factor	Scaled SAR 1-g (W/kg)	Liquid Temp. (°C)	SAR limit 1-g (W/kg)
Front	802.11ax HT40	151/5755	0.9383	0.636	0.18	12.46	12.5	1.0756	0.6841	20.8	1.6
Back	802.11ax HT40	151/5755	0.9383	0.00921	-0.19	12.46	12.5	1.0756	0.0099	20.8	1.6
Bottom	802.11ax HT40	151/5755	0.9383	0.868	-0.17	12.46	12.5	1.0756	0.9336	20.8	1.6

Note:

- 1)The maximum Scaled SAR value is marked in bold. Graph Results refer to Appendix B
- 2)If the reported (scaled) SAR measured at the middle channel or highest output power channel for each test configuration is ≤ 0.8 W/kg then testing at the other channels is not required for such test configuration(s).
- 3)Scaled factor=(Max. Tune-up Power in mW) / (Conducted Power in mW) / (Duty Cycle)
- 4)Scaled SAR=Test SAR * Scaled factor

Antenna2 Result

WIFI_2.4G Head 0mm SAR 1g											
Test position	Test mode	Test Ch./Freq (MHz)	Duty Cycle	SAR 1-g (W/kg)	Power drift (dB)	Conduct power (dBm)	Max. Tune-up Power (dBm)	Scaled factor	Scaled SAR 1-g (W/kg)	Liquid Temp. (°C)	SAR limit 1-g (W/kg)
Back	802.11b	1/2412	0.9688	0.00426	0	13.54	14	1.1475	0.0049	20.8	1.6
Top	802.11b	1/2412	0.9688	0.89	-0.14	13.54	14	1.1475	1.0213	20.8	1.6
Slope	802.11b	1/2412	0.9688	0.552	0	13.54	14	1.1475	0.6334	20.8	1.6

WIFI_5G_ U-NII-1 Head 0mm SAR 1-g											
Test position	Test mode	Test Ch./Freq (MHz)	Duty Cycle	SAR 1-g (W/kg)	Power drift (dB)	Conduct power (dBm)	Max. Tune-up Power (dBm)	Scaled factor	Scaled SAR 1-g (W/kg)	Liquid Temp. (°C)	SAR limit 1-g (W/kg)
Back	802.11ax	46/5230	0.9350	0.00867	-0.18	11.33	12	1.2479	0.0108	20.8	1.6

	HT40										
Top	802.11ax HT40	46/5230	0.9350	0.936	-0.13	11.33	12	1.2479	1.1680	20.8	1.6
Slope	802.11ax HT40	46/5230	0.9350	0.692	-0.17	11.33	12	1.2479	0.8635	20.8	1.6

WIFI_5G_ U-NII-2A Head 0mm SAR 1-g											
Test position	Test mode	Test Ch./Freq (MHz)	Duty Cycle	SAR 1-g (W/kg)	Power drift (dB)	Conduct power (dBm)	Max. Tune-up Power (dBm)	Scaled factor	Scaled SAR 1-g (W/kg)	Liquid Temp. (°C)	SAR limit 1-g (W/kg)
Back	802.11ax HT40	62/5310	0.9349	0.00684	-0.15	11.16	12	1.2979	0.0089	20.8	1.6
Top	802.11ax HT40	62/5310	0.9349	0.898	-0.14	11.16	12	1.2979	1.1655	20.8	1.6
Slope	802.11ax HT40	62/5310	0.9349	0.544	0.01	11.16	12	1.2979	0.7061	20.8	1.6

WIFI_5G_ U-NII-2C Head 0mm SAR 1-g											
Test position	Test mode	Test Ch./Freq (MHz)	Duty Cycle	SAR 1-g (W/kg)	Power drift (dB)	Conduct power (dBm)	Max. Tune-up Power (dBm)	Scaled factor	Scaled SAR 1-g (W/kg)	Liquid Temp. (°C)	SAR limit 1-g (W/kg)
Back	802.11ax HT40	110/5550	0.9366	0.00531	-0.15	11.6	12	1.1707	0.0062	20.8	1.6
Top	802.11ax HT40	110/5550	0.9366	0.86	0.01	11.6	12	1.1707	1.0068	20.8	1.6
Slope	802.11ax HT40	110/5550	0.9366	0.768	0.04	11.6	12	1.1707	0.8991	20.8	1.6

WIFI_5G_ U-NII-3 Head 0mm SAR 1-g											
Test position	Test mode	Test Ch./Freq (MHz)	Duty Cycle	SAR 1-g (W/kg)	Power drift (dB)	Conduct power (dBm)	Max. Tune-up Power (dBm)	Scaled factor	Scaled SAR 1-g (W/kg)	Liquid Temp. (°C)	SAR limit 1-g (W/kg)
Back	802.11ax HT40	159/5795	0.9366	0.00751	-0.18	11.59	12	1.1734	0.0088	20.8	1.6
Top	802.11ax HT40	159/5795	0.9366	0.87	-0.19	11.59	12	1.1734	1.0209	20.8	1.6
Slope	802.11ax HT40	159/5795	0.9366	0.584	-0.04	11.59	12	1.1734	0.6853	20.8	1.6

Note:

- 1)The maximum Scaled SAR value is marked in bold. Graph Results refer to Appendix B
- 2)If the reported (scaled) SAR measured at the middle channel or highest output power channel for each test configuration is ≤ 0.8 W/kg then testing at the other channels is not required for such test configuration(s).
- 3)Scaled factor= (Max. Tune-up Power in mW) / (Conducted Power in mW) / (Duty Cycle)

4) Scaled SAR=Test SAR * Scaled factor

10.3. Measurement of Extremities SAR Data**Antenna1 Result**

Bluetooth Extremities 0mm SAR 10-g											
Test position	Test mode	Test Ch./Freq (MHz)	Duty Cycle	SAR 10-g (W/kg)	Power drift (dB)	Conduct power (dBm)	Max. Tune-up Power (dBm)	Scaled factor	Scaled SAR 10-g (W/kg)	Liquid Temp. (°C)	SAR limit 10-g (W/kg)
Front	DH5	39/2441	0.7707	0.0224	-0.15	11.35	11.5	1.3431	0.0301	20.8	4.0
Back	DH5	39/2441	0.7707	0.0031	-0.19	11.35	11.5	1.3431	0.0042	20.8	4.0
Bottom	DH5	39/2441	0.7707	0.0521	-0.09	11.35	11.5	1.3431	0.0700	20.8	4.0

WIFI_2.4G Extremities 0mm SAR 10-g											
Test position	Test mode	Test Ch./Freq (MHz)	Duty Cycle	SAR 10-g (W/kg)	Power drift (dB)	Conduct power (dBm)	Max. Tune-up Power (dBm)	Scaled factor	Scaled SAR 10-g (W/kg)	Liquid Temp. (°C)	SAR limit 10-g (W/kg)
Front	802.11b	1/2412	0.971	0.321	-0.17	12.66	13	1.1137	0.3575	20.8	4.0
Back	802.11b	1/2412	0.971	0.00368	-0.09	12.66	13	1.1137	0.0041	20.8	4.0
Bottom	802.11b	1/2412	0.971	0.516	-0.13	12.66	13	1.1137	0.5747	20.8	4.0

WIFI_5G_ U-NII-1 Extremities 0mm SAR 10-g											
Test position	Test mode	Test Ch./Freq (MHz)	Duty Cycle	SAR 10-g (W/kg)	Power drift (dB)	Conduct power (dBm)	Max. Tune-up Power (dBm)	Scaled factor	Scaled SAR 10-g (W/kg)	Liquid Temp. (°C)	SAR limit 10-g (W/kg)
Front	802.11a	48/5240	0.9804	0.106	0.13	11.24	12.5	1.3633	0.1445	20.8	4.0
Back	802.11a	48/5240	0.9804	0.0034	-0.16	11.24	12.5	1.3633	0.0046	20.8	4.0
Bottom	802.11a	48/5240	0.9804	0.235	0.12	11.24	12.5	1.3633	0.3204	20.8	4.0

WIFI_5G_ U-NII-2A Extremities 0mm SAR 10-g											
Test position	Test mode	Test Ch./Freq (MHz)	Duty Cycle	SAR 10-g (W/kg)	Power drift (dB)	Conduct power (dBm)	Max. Tune-up Power (dBm)	Scaled factor	Scaled SAR 10-g (W/kg)	Liquid Temp. (°C)	SAR limit 10-g (W/kg)
Front	802.11ax VHT40	62/5310	0.924	0.122	0.13	12.22	12.5	1.1543	0.1408	20.8	4.0
Back	802.11ax VHT40	62/5310	0.924	0.00396	-0.18	12.22	12.5	1.1543	0.0046	20.8	4.0
Bottom	802.11ax VHT40	62/5310	0.924	0.23	0.15	12.22	12.5	1.1543	0.2655	20.8	4.0

WIFI_5G_ U-NII-2C Extremities 0mm SAR 10-g											
Test position	Test mode	Test Ch./Freq (MHz)	Duty Cycle	SAR 10-g (W/kg)	Power drift (dB)	Conduct power (dBm)	Max. Tune-up Power (dBm)	Scaled factor	Scaled SAR 10-g (W/kg)	Liquid Temp. (°C)	SAR limit 10-g (W/kg)
Front	802.11a	140/5700	0.9804	0.137	0.08	12.23	12.5	1.0854	0.1487	20.8	4.0
Back	802.11a	140/5700	0.9804	0.00421	-0.16	12.23	12.5	1.0854	0.0046	20.8	4.0
Bottom	802.11a	140/5700	0.9804	0.267	0.02	12.23	12.5	1.0854	0.2898	20.8	4.0

WIFI_5G_ U-NII-3 Extremities 0mm SAR 10-g											
Test position	Test mode	Test Ch./Freq (MHz)	Duty Cycle	SAR 10-g (W/kg)	Power drift (dB)	Conduct power (dBm)	Max. Tune-up Power (dBm)	Scaled factor	Scaled SAR 10-g (W/kg)	Liquid Temp. (°C)	SAR limit 10-g (W/kg)
Front	802.11ax VHT40	151/5755	0.9383	0.176	0.18	12.46	12.5	1.0756	0.1893	20.8	4.0
Back	802.11ax VHT40	151/5755	0.9383	0.00465	-0.19	12.46	12.5	1.0756	0.0050	20.8	4.0
Bottom	802.11ax VHT40	151/5755	0.9383	0.274	-0.17	12.46	12.5	1.0756	0.2947	20.8	4.0

Antenna2 Result

WIFI_2.4G Extremities 0mm SAR 10-g											
Test position	Test mode	Test Ch./Freq (MHz)	Duty Cycle	SAR 10-g (W/kg)	Power drift (dB)	Conduct power (dBm)	Max. Tune-up Power (dBm)	Scaled factor	Scaled SAR 10-g (W/kg)	Liquid Temp. (°C)	SAR limit 10-g (W/kg)
Back	802.11b	1/2412	0.9688	0.00213	0	13.54	14	1.1475	0.0024	20.8	4.0
Top	802.11b	1/2412	0.9688	0.367	-0.14	13.54	14	1.1475	0.4211	20.8	4.0
Slope	802.11b	1/2412	0.9688	0.26	0	13.54	14	1.1475	0.2984	20.8	4.0

WIFI_5G_ U-NII-1 Extremities 0mm SAR 10-g											
Test position	Test mode	Test Ch./Freq (MHz)	Duty Cycle	SAR 10-g (W/kg)	Power drift (dB)	Conduct power (dBm)	Max. Tune-up Power (dBm)	Scaled factor	Scaled SAR 10-g (W/kg)	Liquid Temp. (°C)	SAR limit 10-g (W/kg)
Back	802.11ax VHT40	46/5230	0.9350	0.00298	-0.18	11.33	12	1.2479	0.0037	20.8	4.0
Top	802.11ax VHT40	46/5230	0.9350	0.293	-0.13	11.33	12	1.2479	0.3656	20.8	4.0
Slope	802.11ax VHT40	46/5230	0.9350	0.154	-0.17	11.33	12	1.2479	0.1922	20.8	4.0

WIFI_5G_ U-NII-2A Extremities 0mm SAR 10-g											
Test position	Test mode	Test Ch./Freq (MHz)	Duty Cycle	SAR 10-g (W/kg)	Power drift (dB)	Conduct power (dBm)	Max. Tune-up Power (dBm)	Scaled factor	Scaled SAR 10-g (W/kg)	Liquid Temp. (°C)	SAR limit 10-g (W/kg)
Back	802.11ax VHT40	62/5310	0.9349	0.00352	-0.15	11.16	12	1.2979	0.0046	20.8	4.0
Top	802.11ax VHT40	62/5310	0.9349	0.279	-0.14	11.16	12	1.2979	0.3621	20.8	4.0
Slope	802.11ax VHT40	62/5310	0.9349	0.11	0.01	11.16	12	1.2979	0.1428	20.8	4.0

WIFI_5G_ U-NII-2C Extremities 0mm SAR 10-g											
Test position	Test mode	Test Ch./Freq (MHz)	Duty Cycle	SAR 10-g (W/kg)	Power drift (dB)	Conduct power (dBm)	Max. Tune-up Power (dBm)	Scaled factor	Scaled SAR 10-g (W/kg)	Liquid Temp. (°C)	SAR limit 10-g (W/kg)
Back	802.11ax VHT40	110/5550	0.9366	0.00216	-0.15	11.6	12	1.1707	0.0025	20.8	4.0
Top	802.11ax VHT40	110/5550	0.9366	0.303	0.01	11.6	12	1.1707	0.3457	20.8	4.0
Slope	802.11ax VHT40	110/5550	0.9366	0.173	0.04	11.6	12	1.1707	0.2025	20.8	4.0

WIFI_5G_ U-NII-3 Extremities 0mm SAR 10-g											
Test position	Test mode	Test Ch./Freq (MHz)	Duty Cycle	SAR 10-g (W/kg)	Power drift (dB)	Conduct power (dBm)	Max. Tune-up Power (dBm)	Scaled factor	Scaled SAR 10-g (W/kg)	Liquid Temp. (°C)	SAR limit 10-g (W/kg)
Back	802.11ax VHT40	159/5795	0.9366	0.00298	-0.18	11.59	12	1.1734	0.0035	20.8	4.0
Top	802.11ax VHT40	159/5795	0.9366	0.286	-0.19	11.59	12	1.1734	0.3356	20.8	4.0
Slope	802.11ax VHT40	159/5795	0.9366	0.165	-0.04	11.59	12	1.1734	0.1936	20.8	4.0

Note:

- 1)The maximum Scaled SAR value is marked in bold. Graph Results refer to Appendix B
- 2)If the reported (scaled) SAR measured at the middle channel or highest output power channel for each test configuration is ≤ 0.8 W/kg then testing at the other channels is not required for such test configuration(s).
- 3)Scaled factor=(Max. Tune-up Power in mW) / (Conducted Power in mW) / (Duty Cycle)
- 4)Scaled SAR=Test SAR * Scaled factor

10.4. Simultaneous transmission SAR

Simultaneous transmission SAR test exclusion is determined for each operating configuration and exposure condition according to the reported standalone SAR of each applicable simultaneous transmitting antenna.

When standalone SAR test exclusion applies to an antenna that transmits simultaneously with other antennas, the standalone SAR must be estimated according to following to determine simultaneous transmission SAR test exclusion:

1. $[(\text{max. power of channel, including tune-up tolerance, mW}) / (\text{min. test separation distance, mm})] \times [\sqrt{f(\text{GHz})/x}] \text{ W/kg}$, for test separation distances $\leq 50 \text{ mm}$; where $x = 7.5$ for 1-g SAR and $x = 18.75$ for 10-g SAR.
2. 0.4 W/kg for 1-g SAR and 1.0 W/kg for 10-g SAR, when the test separation distance is $> 50 \text{ mm}$.

Mode	Combination
1	BT+ANT2 WIFI_2.4G
2	BT+ANT2 WIFI_5G
3	ANT1 WIFI_2.4G+ANT2 WIFI_2.4G
4	ANT1 WIFI_2.4G+ANT2 WIFI_5G
5	ANT1 WIFI_5G+ANT2 WIFI_2.4G
6	ANT1 WIFI_5G+ANT2 WIFI_5G

Mode1	Simultaneous transmission Head SAR						
	Antenna1			Antenna2		SUM 1-g SAR (W/kg)	SPLSR
Test Position	BT 1-g SAR (W/kg)	WIFI_2.4G 1-g SAR (W/kg)	WIFI_5G 1-g SAR (W/kg)	WIFI_2.4G 1-g SAR (W/kg)	WIFI_5G 1-g SAR (W/kg)		
Front	0.0549	/	/	0.4	/	0.4549	Excluded
Back	0.0110	/	/	0.0049	/	0.0159	Excluded
Top	0.0797	/	/	1.0213	/	1.1010	Excluded
Bottom	0.1612	/	/	0.1401	/	0.3013	Excluded
Slope	0.4	/	/	0.6334	/	1.0334	Excluded

Mode2	Simultaneous transmission Head SAR						
	Antenna1			Antenna2		SUM 1-g SAR (W/kg)	SPLSR
Test Position	BT 1-g SAR (W/kg)	WIFI_2.4G 1-g SAR (W/kg)	WIFI_5G 1-g SAR (W/kg)	WIFI_2.4G 1-g SAR (W/kg)	WIFI_5G 1-g SAR (W/kg)		
Front	0.0549	/	/	/	0.4	0.4549	Excluded
Back	0.0110	/	/	/	0.0108	0.0218	Excluded
Top	0.0797	/	/	/	1.1680	1.2477	Excluded
Bottom	0.1612	/	/	/	0.136	0.2972	Excluded
Slope	0.4	/	/	/	0.8991	1.2991	Excluded

Mode3	Simultaneous transmission Head SAR						
	Antenna1			Antenna2		SUM	SPLSR
Test	BT	WIFI_2.4G	WIFI_5G	WIFI_2.4G	WIFI_5G		

Position	1-g SAR (W/kg)	1-g SAR (W/kg)	1-g SAR (W/kg)	1-g SAR (W/kg)	1-g SAR (W/kg)	1-g SAR (W/kg)	
Front	/	0.6537	/	0.4	/	1.0537	Excluded
Back	/	0.0104	/	0.0049	/	0.0153	Excluded
Top	/	0.1122	/	1.0213	/	1.1335	Excluded
Bottom	/	1.1471	/	0.1401	/	1.2872	Excluded
Slope	/	0.4	/	0.6334	/	1.0334	Excluded

Mode4	Simultaneous transmission Head SAR						
	Antenna1			Antenna2		SUM 1-g SAR (W/kg)	SPLSR
Test Position	BT 1-g SAR (W/kg)	WIFI_2.4G 1-g SAR (W/kg)	WIFI_5G 1-g SAR (W/kg)	WIFI_2.4G 1-g SAR (W/kg)	WIFI_5G 1-g SAR (W/kg)		
Front	/	0.6537	/	/	0.4	1.0537	Excluded
Back	/	0.0104	/	/	0.0108	0.0212	Excluded
Top	/	0.1122	/	/	1.1680	1.2802	Excluded
Bottom	/	1.1471	/	/	0.136	1.2831	Excluded
Slope	/	0.4	/	/	0.8991	1.2991	Excluded

Mode5	Simultaneous transmission Head SAR						
	Antenna1			Antenna2		SUM 1-g SAR (W/kg)	SPLSR
Test Position	BT 1-g SAR (W/kg)	WIFI_2.4G 1-g SAR (W/kg)	WIFI_5G 1-g SAR (W/kg)	WIFI_2.4G 1-g SAR (W/kg)	WIFI_5G 1-g SAR (W/kg)		
Front	/	/	0.6841	0.4	/	1.0841	Excluded
Back	/	/	0.0124	0.0049	/	0.0173	Excluded
Top	/	/	0.1538	1.0213	/	1.1751	Excluded
Bottom	/	/	1.0675	0.1401	/	1.2076	Excluded
Slope	/	/	0.4	0.6334	/	1.0334	Excluded

Mode6	Simultaneous transmission Head SAR						
	Antenna1			Antenna2		SUM 1-g SAR (W/kg)	SPLSR
Test Position	BT 1-g SAR (W/kg)	WIFI_2.4G 1-g SAR (W/kg)	WIFI_5G 1-g SAR (W/kg)	WIFI_2.4G 1-g SAR (W/kg)	WIFI_5G 1-g SAR (W/kg)		
Front	/	/	0.6841	/	0.4	1.0841	Excluded
Back	/	/	0.0124	/	0.0108	0.0232	Excluded
Top	/	/	0.1538	/	1.1680	1.3218	Excluded
Bottom	/	/	1.0675	/	0.136	1.2035	Excluded
Slope	/	/	0.4	/	0.8991	1.2991	Excluded

Note: SUM 1-g SAR < 1.6W/kg, so the SPLSR excluded

Mode1	Simultaneous transmission Extremities SAR						
	Antenna1			Antenna2		SUM 10-g SAR (W/kg)	SPLSR
Test Position	BT 10-g SAR (W/kg)	WIFI_2.4G 10-g SAR (W/kg)	WIFI_5G 10-g SAR (W/kg)	WIFI_2.4G 10-g SAR (W/kg)	WIFI_5G 10-g SAR (W/kg)		
Front	0.0301	/	/	1.0	/	1.0301	Excluded
Back	0.0042	/	/	0.0024	/	0.0066	Excluded
Top	0.0319	/	/	0.4211	/	0.4530	Excluded
Bottom	0.0700	/	/	0.0565	/	0.1265	Excluded
Slope	1.0	/	/	0.2984	/	1.2984	Excluded

Mode2	Simultaneous transmission Extremities SAR						
	Antenna1			Antenna2		SUM 10-g SAR (W/kg)	SPLSR
Test Position	BT 10-g SAR (W/kg)	WIFI_2.4G 10-g SAR (W/kg)	WIFI_5G 10-g SAR (W/kg)	WIFI_2.4G 10-g SAR (W/kg)	WIFI_5G 10-g SAR (W/kg)		
Front	0.0301	/	/	/	1.0	1.0301	Excluded
Back	0.0042	/	/	/	0.0046	0.0088	Excluded
Top	0.0319	/	/	/	0.3656	0.3975	Excluded
Bottom	0.0700	/	/	/	0.0544	0.1244	Excluded
Slope	1.0	/	/	/	0.2025	1.2025	Excluded

Mode3	Simultaneous transmission Extremities SAR						
	Antenna1			Antenna2		SUM 10-g SAR (W/kg)	SPLSR
Test Position	BT 10-g SAR (W/kg)	WIFI_2.4G 10-g SAR (W/kg)	WIFI_5G 10-g SAR (W/kg)	WIFI_2.4G 10-g SAR (W/kg)	WIFI_5G 10-g SAR (W/kg)		
Front	/	0.3575	/	1.0	/	1.3575	Excluded
Back	/	0.0041	/	0.0024	/	0.0065	Excluded
Top	/	0.0449	/	0.4211	/	0.4660	Excluded
Bottom	/	0.5747	/	0.0565	/	0.6312	Excluded
Slope	/	1.0	/	0.2984	/	1.2984	Excluded

Mode4	Simultaneous transmission Extremities SAR						
	Antenna1			Antenna2		SUM 10-g SAR (W/kg)	SPLSR
Test Position	BT 10-g SAR (W/kg)	WIFI_2.4G 10-g SAR (W/kg)	WIFI_5G 10-g SAR (W/kg)	WIFI_2.4G 10-g SAR (W/kg)	WIFI_5G 10-g SAR (W/kg)		
Front	/	0.3575	/	/	1.0	1.3575	Excluded
Back	/	0.0041	/	/	0.0046	0.0087	Excluded
Top	/	0.0449	/	/	0.3656	0.4105	Excluded
Bottom	/	0.5747	/	/	0.0544	0.6291	Excluded
Slope	/	1.0	/	/	0.2025	1.2025	Excluded

Mode5	Simultaneous transmission Extremities SAR						
	Antenna1			Antenna2			SUM 10-g SAR (W/kg)
Test Position	BT 10-g SAR (W/kg)	WIFI_2.4G 10-g SAR (W/kg)	WIFI_5G 10-g SAR (W/kg)	WIFI_2.4G 10-g SAR (W/kg)	WIFI_5G 10-g SAR (W/kg)		
Front	/	/	0.1893	1.0	/	1.1893	Excluded
Back	/	/	0.0050	0.0024	/	0.0074	Excluded
Top	/	/	0.0615	0.4211	/	0.4826	Excluded
Bottom	/	/	0.3204	0.0565	/	0.3769	Excluded
Slope	/	/	1.0	0.2984	/	1.2984	Excluded

Mode6	Simultaneous transmission Extremities SAR						
	Antenna1			Antenna2			SUM 10-g SAR (W/kg)
Test Position	BT 10-g SAR (W/kg)	WIFI_2.4G 10-g SAR (W/kg)	WIFI_5G 10-g SAR (W/kg)	WIFI_2.4G 10-g SAR (W/kg)	WIFI_5G 10-g SAR (W/kg)		
Front	/	/	0.1893	/	1.0	1.1893	Excluded
Back	/	/	0.0050	/	0.0046	0.0096	Excluded
Top	/	/	0.0615	/	0.3656	0.4271	Excluded
Bottom	/	/	0.3204	/	0.0544	0.3748	Excluded
Slope	/	/	1.0	/	0.2025	1.2025	Excluded

Note: SUM 10-g SAR < 4.0W/kg, so the SPLSR excluded

APPENDIX

Appendix A: System Validation Plots

Appendix B: Highest Test Plots

Appendix C: Calibration Certification

Appendix D: Test setup photograph

END REPORT