

TEST REPORT

Applicant: Cloud Cover Media, Inc. a subsidiary of Sirius XM Radio LLC

Address of Applicant: 953 N Sycamore Ave, Floor 8; Los Angeles, CA 90038; United States

Manufacturer: Huaren Technology Company Limited

Address of Manufacturer: 1203-1206, Yingfengnian Building, No.49, Xiangyin Road, Nanlian Community, Longgang District, Shenzhen, 518116, China

Factory: N/A

Address of Factory: N/A

Equipment Under Test (EUT)

Product Name: Music player

Model No.: PCCY5, G9Y5

Trade Mark: CloudBox

FCC ID: 2A6KO-PCCY5

Applicable standards: 47 CFR Part 15.407

Date of sample receipt: Mar. 26, 2025

Date of Test: Mar. 26, 2025 ~ May. 17, 2025

Date of report issued: May. 17, 2025

Test Result : PASS *

* In the configuration tested, the EUT complied with the standards specified above.

Authorized Signature:

Robinson Luo
Laboratory Manager

This results shown in this test report refer only to the sample(s) tested, this test report cannot be reproduced, except in full, without prior written permission of the company. The report would be invalid without specific stamp of test institute and the signatures of compiler and approver.

2 Version

Version No.	Date	Description
00	May. 17, 2025	Original

Prepared By:

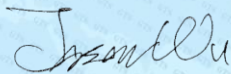

Date:

May. 17, 2025

Project Engineer

Check By:



Date:

May. 17, 2025

Reviewer

3 Contents

	Page
1 COVER PAGE	1
2 VERSION	2
3 CONTENTS	3
4 TEST SUMMARY	4
5 GENERAL INFORMATION	5
5.1 GENERAL DESCRIPTION OF EUT	5
5.2 CARRIER FREQUENCY AND CHANNEL	6
5.3 TEST FACILITY	7
5.4 TEST LOCATION	7
5.5 DESCRIPTION OF SUPPORT UNITS	7
5.6 DEVIATION FROM STANDARDS.....	7
5.7 ABNORMALITIES FROM STANDARD CONDITIONS.....	7
5.8 ADDITIONAL INSTRUCTIONS.....	7
6 TEST INSTRUMENTS LIST	8
7 TEST CONFIGURATION OF EQUIPMENT UNDER TEST.....	9
7.1 TEST SETUP.....	9
7.2 DFS DETECTION THRESHOLDS FOR MASTER DEVICES AND CLIENT DEVICES WITH RADAR DETECTION	10
8 REQUIREMENTS AND PARAMETERS FOR DFS TEST	11
8.1 APPLICABILITY OF DFS REQUIREMENTS.....	11
8.2 DFS RESPONSE REQUIREMENT VALUES	12
8.3 SHORT PULSE RADAR TEST WAVEFORMS	13
8.4 LONG PULSE RADAR TEST WAVEFORM.....	14
8.5 FREQUENCY HOPPING RADAR TEST WAVEFORM	14
9 DFS TEST RESULTS.....	15
9.1 IN-SERVICE MONITORING: CHANNEL MOVE TIME, CHANNEL CLOSING TRANSMISSION TIME AND NON-OCCUPANCY PERIOD	15
9.1.1 <i>Limit of In-Service Monitoring</i>	15
9.1.2 <i>Test Procedures</i>	15
9.1.3 <i>Result of Channel Move Time, Channel Closing Transmission Time and Non-Occupancy Period for Client Beacon Test</i>	16
9.1.4 <i>Channel Move Time, Channel Closing Transmission Time and Non-Occupancy Period for Client Beacon Test Plots</i>	16
10 TEST SETUP PHOTO	17
11 EUT CONSTRUCTIONAL DETAILS.....	17
12 APPENDIX	18
12.1 DFS DETECTION THRESHOLDS.....	18
12.2 CHANNEL MOVE TIME AND CHANNEL CLOSING TRANSMISSION TIME.....	26
12.3 NON-OCCUPANCY PERIOD.....	31

4 Test Summary

UNII	Bandwidth and Channel	Description	Limit	Result
UNII Band 2-A 5250-5350MHz & UNII Band 2-C 5470-5725MHz	20MHz (CH52) 5260MHz	Channel Move Time	< 10s	Pass
		Channel Closing Transmission time	< 260ms	Pass
		Non-Occupancy Period and Client Beacon Test	30 minutes	Pass

Note: Since the product is client without radar detection function, only Channel Move Time, Channel Closing Transmission Time and Non-Occupancy Period Test are required to be performed.

Test according to KDB 905462 D02 UNII DFS Compliance Procedures New Rules v02 & KDB 905462 D03 UNII Clients Without Radar Detection New Rules v01r02

5 General Information

5.1 General Description of EUT

Product Name:	Music player
Model No.:	PCCY5, G9Y5
Test Model No.:	PCCY5
Remark: All above models are identical in the same PCB layout, interior structure and electrical circuits. The difference is model name .	
Test sample(s) ID:	GTSL2025040440-1
Sample(s) Status	Engineer sample
Serial No.:	N/A
Modulation Type:	802.11a/n/ac /ax: OFDM
Operating Frequency:	U-NII-2A:5250~5350MHz U-NII-2C:5470~5725MHz
TPC Support	NO
Operation Mode:	Slaver device without radar detection function
Sample Type:	<input checked="" type="checkbox"/> Mobile <input type="checkbox"/> Portable <input type="checkbox"/> Fix Location
Antenna Type:	Integral Antenna
Antenna Gain:	1.63dBi @Band 2A, 2.07dBi @Band 2C
Power supply:	DC 5V from adapter

Remark:

1. Antenna gain information provided by the customer
2. The relevant information of the sample is provided by the entrusting company, and the laboratory is not responsible for its authenticity.

5.2 Carrier Frequency and Channel

U-NII-1

CHANNEL	FREQUENCY	CHANNEL	FREQUENCY
36	5180 MHz	44	5220 MHz
38	5190 MHz	46	5230 MHz
40	5200 MHz	48	5240 MHz
42	5210 MHz		

U-NII-2A

CHANNEL	FREQUENCY	CHANNEL	FREQUENCY
52	5260 MHz	60	5300 MHz
54	5270 MHz	62	5310 MHz
56	5280 MHz	64	5320 MHz
58	5290 MHz		

U-NII-2C

CHANNEL	FREQUENCY	CHANNEL	FREQUENCY
100	5500 MHz	112	5560 MHz
102	5510 MHz	116	5580 MHz
104	5520 MHz	132	5660 MHz
106	5530 MHz	134	5670 MHz
108	5540 MHz	136	5680 MHz
110	5550 MHz	140	5700 MHz

U-NII-3

CHANNEL	FREQUENCY	CHANNEL	FREQUENCY
149	5745 MHz	159	5795 MHz
151	5755 MHz	161	5805 MHz
153	5765 MHz	163	5815 MHz
155	5775 MHz	165	5825 MHz
157	5785 MHz		

TDWR

CHANNEL	FREQUENCY	CHANNEL	FREQUENCY
118	5590 MHz	124	5620 MHz
120	5600 MHz	126	5630 MHz
106	5530 MHz	128	5640 MHz

5.3 Test Facility

The test facility is recognized, certified, or accredited by the following organizations:

- **FCC —Registration No.: 381383**

Designation Number: CN5029

Global United Technology Services Co., Ltd., Shenzhen EMC Laboratory has been registered and fully described in a report filed with the (FCC) Federal Communications Commission. The acceptance letter from the FCC is maintained in files.

- **ISED —Registration No.: 9079A**

CAB identifier: CN0091

The 3m Semi-anechoic chamber of Global United Technology Services Co., Ltd. has been registered by Certification and Engineering Bureau of ISED for radio equipment testing.

- **NVLAP (LAB CODE:600179-0)**

Global United Technology Services Co., Ltd., is accredited by the National Voluntary Laboratory Accreditation Program (NVLAP).

5.4 Test Location

All other tests were performed at:

Global United Technology Services Co., Ltd.

Address: No. 123-128, Tower A, Jinyuan Business Building, No.2, Laodong Industrial Zone, Xixiang Road, Baoan District, Shenzhen, Guangdong, China 518102

Tel: 0755-27798480

Fax: 0755-27798960

5.5 Description of Support Units

None.

5.6 Deviation from Standards

None.

5.7 Abnormalities from Standard Conditions

None.

5.8 Additional Instructions

Software (Used for test) from client

Built-in by manufacturer, power set default.

6 Test Instruments list

RF Conducted Test:						
Item	Test Equipment	Manufacturer	Model No.	Serial No.	Cal.Date (mm-dd-yy)	Cal.Due date (mm-dd-yy)
1	MXA Signal Analyzer	Agilent	N9020A	GTS566	Apr. 11, 2025	Apr. 10, 2026
2	EMI Test Receiver	R&S	ESCI 7	GTS552	Apr. 12, 2025	Apr. 11, 2026
3	PSA Series Spectrum Analyzer	Agilent	E4440A	GTS536	Apr. 11, 2025	Apr. 10, 2026
4	MXG vector Signal Generator	Agilent	N5182A	GTS567	Apr. 11, 2025	Apr. 10, 2026
5	ESG Analog Signal Generator	Agilent	E4428C	GTS568	Apr. 11, 2025	Apr. 10, 2026
6	Wideband Power Meter	Keysight	N1924A	GTS673	Apr. 11, 2025	Apr. 10, 2026
7	USB RF Power Sensor	DARE	RPR3006W	GTS569	Apr. 11, 2025	Apr. 10, 2026
8	RF Switch Box	Shongyi	RFSW3003328	GTS571	Apr. 11, 2025	Apr. 10, 2026
9	Programmable Constant Temp & Humi Test Chamber	WEWON	WHTH-150L-40-880	GTS572	Apr. 11, 2025	Apr. 10, 2026
10	Thermo meter	JINCHUANG	GSP-8A	GTS641	Apr. 15, 2025	Apr. 14, 2026
11	Attenuator	/	/	/	Apr. 11, 2025	Apr. 10, 2026

General used equipment:						
Item	Test Equipment	Manufacturer	Model No.	Inventory No.	Cal.Date (mm-dd-yy)	Cal.Due date (mm-dd-yy)
1	Barometer	KUMAO	SF132	GTS647	Aug. 17, 2024	Aug. 16, 2025

7 Test Configuration of Equipment Under Test

7.1 Test Setup

Master Modes

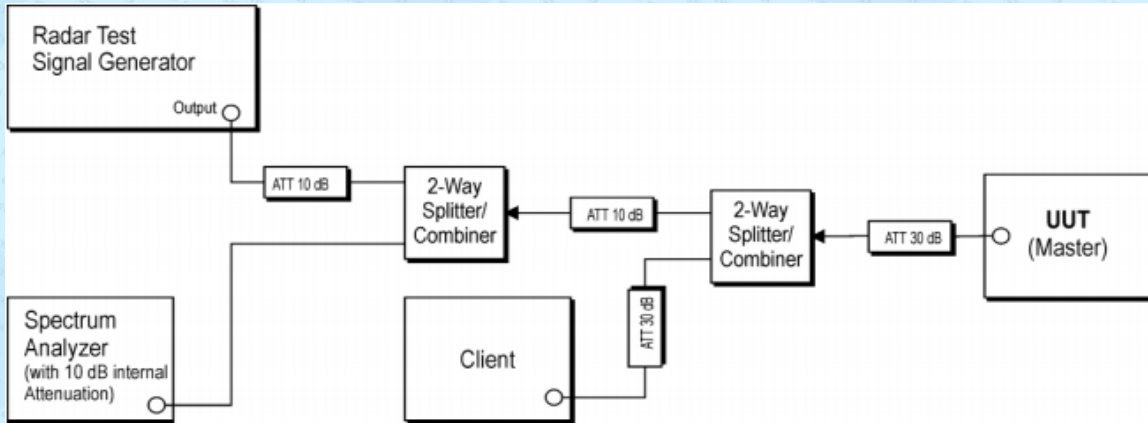

Client with injection at the Client Modes

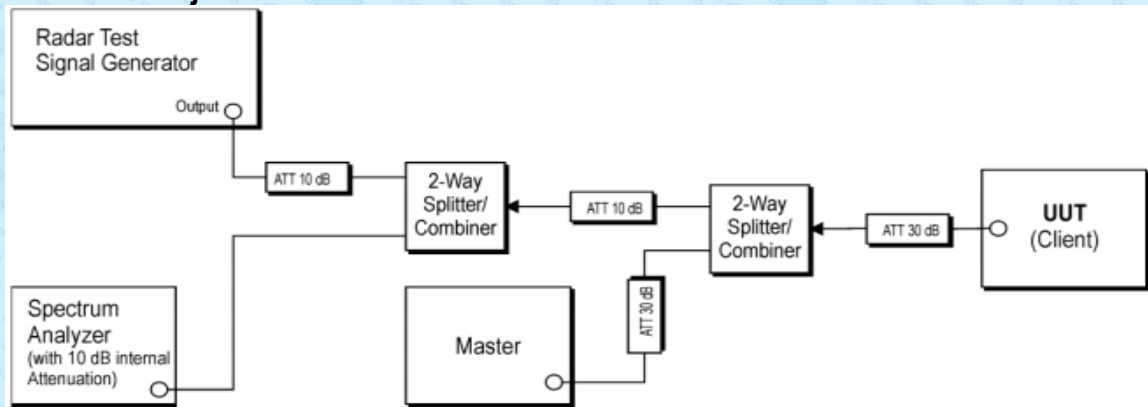

Client with injection at the Master Modes

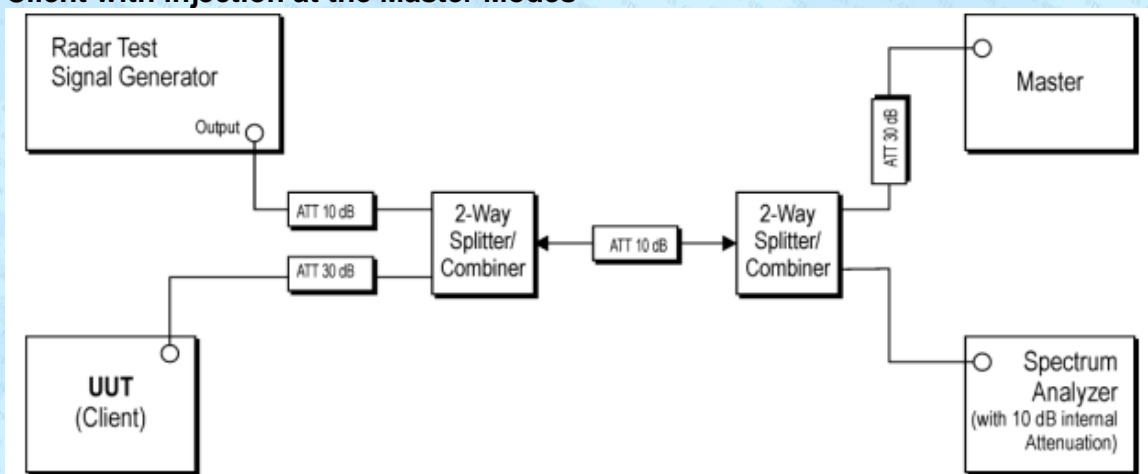

7.2 DFS Detection Thresholds for Master Devices and Client Devices with Radar Detection

Maximum Transmit Power	Value (See Notes 1, 2, and 3)
EIRP \geq 200 milliwatt	-64 dBm
EIRP < 200 milliwatt and power spectral density < 10 dBm/MHz	-62 dBm
EIRP < 200 milliwatt that do not meet the power spectral density requirement	-64 dBm

Note 1: This is the level at the input of the receiver assuming a 0 dBi receive antenna.

Note 2: Throughout these test procedures an additional 1 dB has been added to the amplitude of the test transmission waveforms to account for variations in measurement equipment. This will ensure that the test signal is at or above the detection threshold level to trigger a DFS response.

Note3: EIRP is based on the highest antenna gain.

8 Requirements and Parameters for DFS Test

8.1 Applicability of DFS Requirements

EUT is client and operates as client without radar detection function.

Table 1: Applicability of DFS Requirements Prior to Use of a Channel

Requirement	Operational Mode		
	Master	Client Without Radar Detection	Client With Radar Detection
Non-Occupancy Period	Yes	Not required	Yes
DFS Detection Threshold	Yes	Not required	Yes
Channel Availability Check Time	Yes	Not required	Not required
U-NII Detection Bandwidth	Yes	Not required	Yes

Table 2: Applicability of DFS requirements during normal operation

Requirement	Operational Mode		
	Master	Client Without Radar Detection	Client With Radar Detection
DFS Detection Threshold	Yes	Not required	Yes
Channel Closing Transmission Time	Yes	Yes	Yes
Channel Move Time	Yes	Yes	Yes
U-NII Detection Bandwidth	Yes	Not required	Yes
Client Beacon Test	N/A	Yes	Yes

Additional requirements for devices with multiple bandwidth modes	Operational Mode	
	Master or Client With Radar Detection	Client Without Radar Detection
U-NII Detection Bandwidth and Statistical Performance Check	All BW modes must be tested	Not required
Channel Move Time and Channel Closing Transmission Time	Test using widest BW mode available	Test using the widest BW mode available for the link
All other tests	Any single BW mode	Not required

Note

Frequencies selected for statistical performance check should include several frequencies within the radar detection bandwidth and frequencies near the edge of the radar detection bandwidth. For 802.11 devices it is suggested to select frequencies in each of the bonded 20 MHz channels and the channel center frequency.

8.2 DFS Response requirement values

Parameter	Value
Non-occupancy period	Minimum 30 minutes
Channel Availability Check Time	60 seconds
Channel Move Time	10 seconds See Note 1.
Channel Closing Transmission Time	200 milliseconds + an aggregate of 60 milliseconds over remaining 10 second period. See Notes 1 and 2.
U-NII Detection Bandwidth	Minimum 100% of the 99% power bandwidth See Note 3.

Note 1: The instant that the Channel Move Time and the Channel Closing Transmission Time begins is as follows:

- For the Short pulse radar Test Signals this instant is the end of the Burst.
- For the Frequency Hopping radar Test Signal, this instant is the end of the last radar Burst generated.
- For the Long Pulse radar Test Signal this instant is the end of the 12 second period defining the radar transmission.

Note 2: The Channel Closing Transmission Time is comprised of 200 milliseconds starting at the beginning of the Channel Move Time plus any additional intermittent control signals required to facilitate Channel changes (an aggregate of 60 milliseconds) during the remainder of the 10 second period. The aggregate duration of control signals will not count quiet periods in between transmissions.

Note 3: During the U-NII Detection Bandwidth detection test, radar type 0 is used and for each frequency step the minimum percentage of detection is 90%. Measurements are performed with no data traffic.

8.3 Short Pulse Radar Test Waveforms

As the EUT is a Client Device with no Radar Detection, only one type radar pulse is required for the testing. Radar Pulse type 0 was used in the evaluation of the Client device for the purpose of measuring the Channel Move Time and the Channel Closing Transmission Time.

Radar Type	Pulse Width (μsec)	PRI (μsec)	Number of Pulses	Minimum Percentage of Successful Detection	Minimum Trials
0	1	1428	18	60%	30
1	1	Test A Test B	Roundup $\left\{ \begin{array}{l} \left(\frac{1}{360} \right) \cdot \\ \left(\frac{19 \cdot 10^6}{PRI_{\mu sec}} \right) \end{array} \right\}$	60%	30
2	1-5	150-230	23-29	60%	30
3	6-10	200-500	16-18	60%	30
4	11-20	200-500	12-16	60%	30
Aggregate (Radar Types 1-4)				80%	120
Note 1: Short Pulse Radar Type 0 should be used for the detection bandwidth test, channel move time, and channel closing time tests.					

Test A: 15 unique PRI values randomly selected from the list of 23 PRI values in Table 5a

Test B: 15 unique PRI values randomly selected within the range of 518-3066 μsec, with a minimum increment of 1 μsec, excluding PRI values selected in Test A

A minimum of 30 unique waveforms are required for each of the short pulse radar types 2 through 4. For short pulse radar type 1, the same waveform is used a minimum of 30 times. If more than 30 waveforms are used for short pulse radar types 2 through 4, then each additional waveform must also be unique and not repeated from the previous waveforms.

If more than 30 waveforms are used for Short Pulse Radar Type 1, then each additional waveform is generated with Test B and must also be unique and not repeated from the previous waveforms in Tests A or B.

The aggregate is the average of the percentage of successful detections of short pulse radar types 1-4.

8.4 Long Pulse Radar Test Waveform

Radar Type	Pulse Width (μsec)	Chirp Width (MHz)	PRI (μsec)	Number of Pulses per Burst	Number of Bursts	Minimum Percentage of Successful Detection	Minimum Number of Trials
5	50-100	5-20	1000-2000	1-3	8-20	80%	30

The parameters for this waveform are randomly chosen. Thirty unique waveforms are required for the Long Pulse Radar Type waveforms. If more than 30 waveforms are used for the Long Pulse Radar Type waveforms, then each additional waveform must also be unique and not repeated from the previous waveforms.

8.5 Frequency Hopping Radar Test Waveform

Radar Type	Pulse Width (μsec)	PRI (μsec)	Pulses per Hop	Hopping Rate (kHz)	Hopping Sequence Length (msec)	Minimum Percentage of Successful Detection	Minimum Number of Trials
6	1	333	9	0.333	300	70%	30

For the Frequency Hopping Radar Type, the same Burst parameters are used for each waveform. The hopping sequence is different for each waveform and a 100-length segment is selected from the hopping sequence defined by the following algorithm:

The first frequency in a hopping sequence is selected randomly from the group of 475 integer frequencies from 5250 – 5724 MHz. Next, the frequency that was just chosen is removed from the group and a frequency is randomly selected from the remaining 474 frequencies in the group. This process continues until all 475 frequencies are chosen for the set. For selection of a random frequency, the frequencies remaining within the group are always treated as equally likely.

9 DFS Test Results

9.1 In-Service Monitoring: Channel Move Time, Channel Closing Transmission Time and Non-Occupancy Period

9.1.1 Limit of In-Service Monitoring

The EUT has In-Service Monitoring function to continuously monitor the radar signals, If radar is detected, it must leave the channel (Shutdown). The Channel Move Time to cease all transmissions on the current Channel upon detection of a Radar Waveform above the DFS Detection Threshold within 10 sec. The total duration of Channel Closing Transmission Time is comprised of 200 milliseconds starting at the beginning of the Channel Move Time plus any additional intermittent control signals required to facilitate Channel changes (an aggregate of 60 milliseconds) during the remainder of the 10 second period. The aggregate duration of control signals will not count quiet periods in between transmissions.

Non-Occupancy Period time is 30 minute during which a Channel will not be utilized after a Radar Waveform is detected on that Channel. The non-associated Client Beacon Test is during the 30 minutes observation time. The EUT should not make any transmissions in the DFS band after EUT power up.

9.1.2 Test Procedures

1. The radar pulse generator is setup to provide a pulse at frequency that the Master and Client are operating. A type 0 radar pulse with a 1us pulse width and a 1428 us PRI is used for the testing.
2. The vector signal generator is adjusted to provide the radar burst (18 pulses) at a level of approximately -62dBm at the antenna of the Master device.
3. A trigger is provided from the pulse generator to the DFS monitoring system in order to capture the traffic and the occurrence of the radar pulse.
4. A U-NII device operating as a Client Device will associate with the Master at Channel. The MPEG file "TestFile.mpg" specified by the FCC is streamed from the "file computer" through the Master to the Client Device and played in full motion video using Media Player Classic Ver. 6.4.8.6 in order to properly load the network for the entire period of the test.
5. When a radar Burst with a level equal to the DFS Detection Threshold + 1dB is generated on the Operating Channel of the U-NII device. At time T0 the Radar Waveform generator sends a Burst of pulse of the radar waveform at Detection Threshold + 1dB.
6. Observe the transmissions of the EUT at the end of the radar Burst on the Operating Channel. Measure and record the transmissions from the EUT during the observation time (Channel Move Time). One 12 seconds plot is reported for the Short Pulse Radar Types 1. The plot for the Short Pulse Radar Types start at the end of the radar burst. The Channel Move Time will be calculated based on the zoom in 600ms plot of the Short Pulse Radar Type.

7. Measurement of the aggregate duration of the Channel Closing Transmission Time method. With the spectrum analyzer set to zero span tuned to the center frequency of the EUT operating channel at the radar simulated frequency, peak detection, and max hold, the dwell time per bin is given by: **Dwell (0.4ms)= S (12000ms) / B (30000)**; where Dwell is the dwell time per spectrum analyzer sampling bin, S is the sweep time and B is the number of spectrum analyzer sampling bins. An upper bound of the aggregate duration of the intermittent control signals of Channel Closing Transmission Time is calculated by: **C (ms)= N X Dwell (0.4 ms)**; where C is the Closing Time, N is the number of spectrum analyzer sampling bins (intermittent control signals) showing a U-NII transmission and Dwell is the dwell time per bin.

Measure the EUT for more than 30 minutes following the channel move time to verify that no transmissions or beacons occur on this Channel.

9.1.3 Result of Channel Move Time, Channel Closing Transmission Time and Non-Occupancy Period for Client Beacon Test

Measurement Data: The detailed test data see Appendix

9.1.4 Channel Move Time, Channel Closing Transmission Time and Non-Occupancy Period for Client Beacon Test Plots

Measurement Data: The detailed test data see Appendix

10 Test Setup Photo

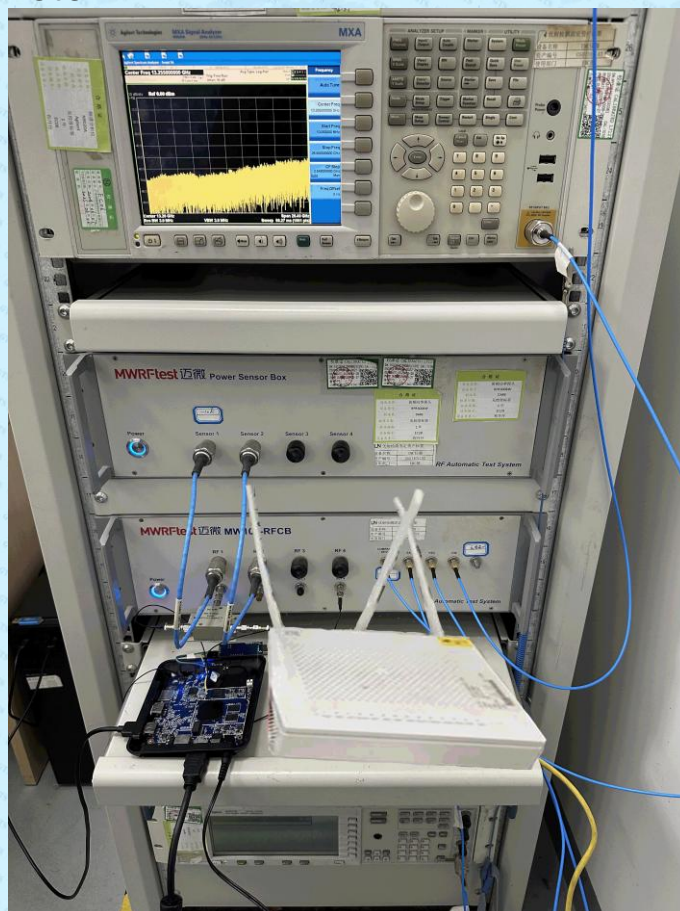

NOTE:

Router Model: ZXHN F670

Restart time of the router and EUT network: 90s; Router FCC ID: Q78-ZXHNF670E.

11 EUT Constructional Details

Refer to the External Photos and Internal Photos for details.

12 Appendix

12.1 DFS Detection Thresholds

Test Result

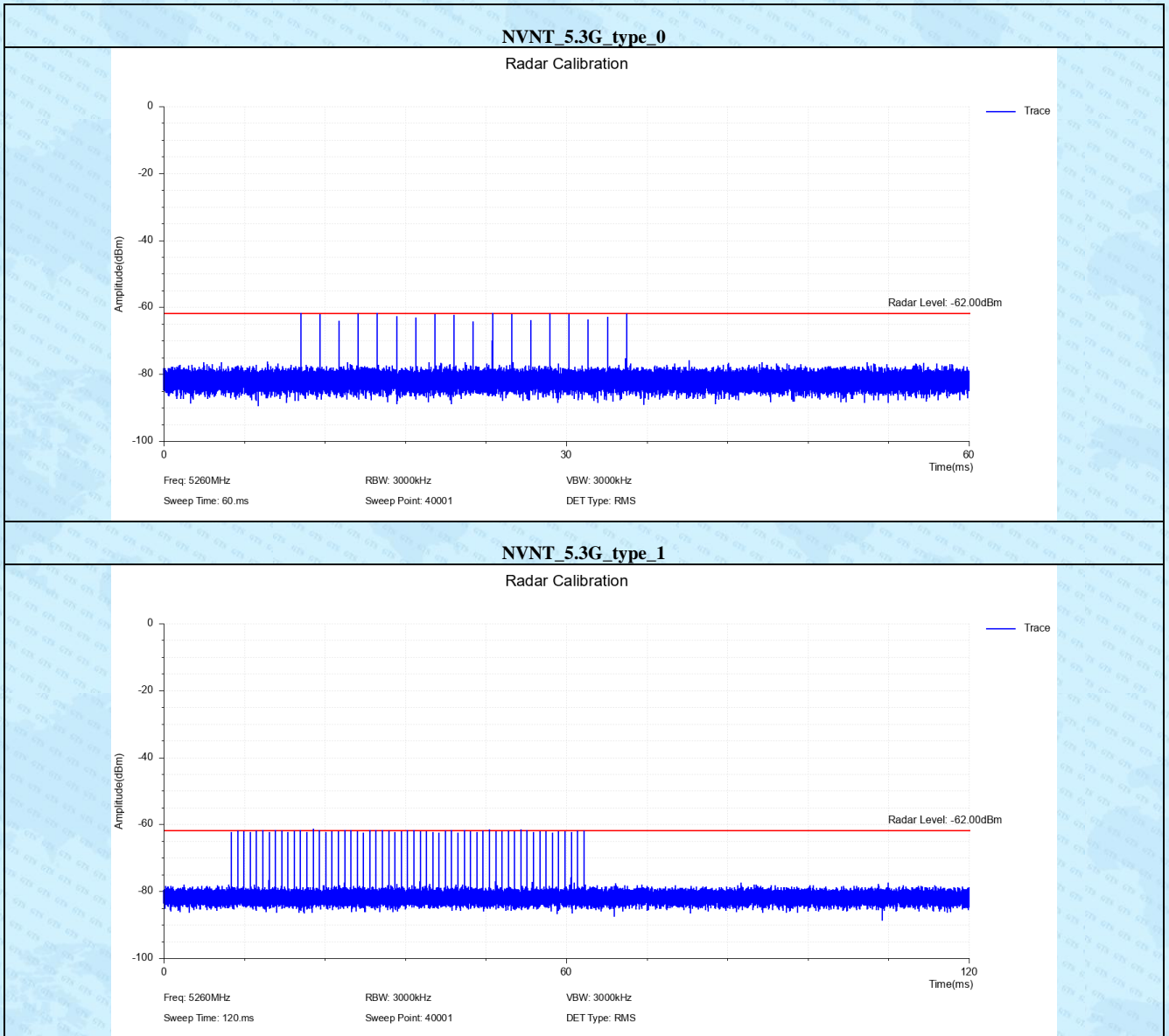

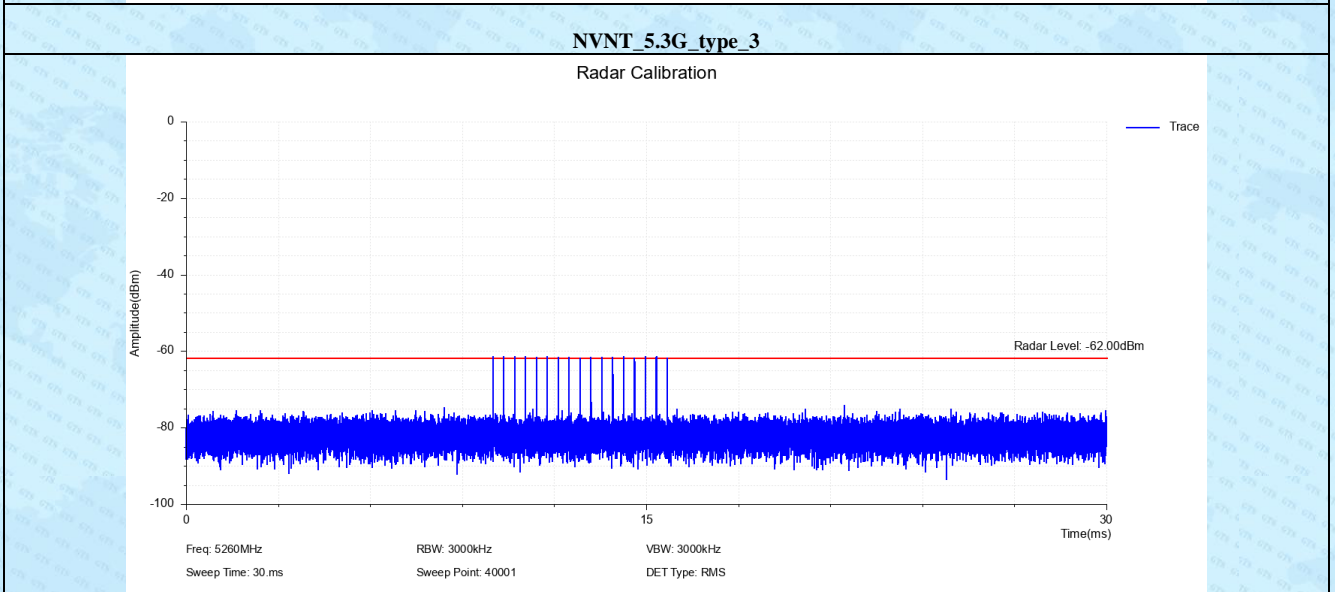
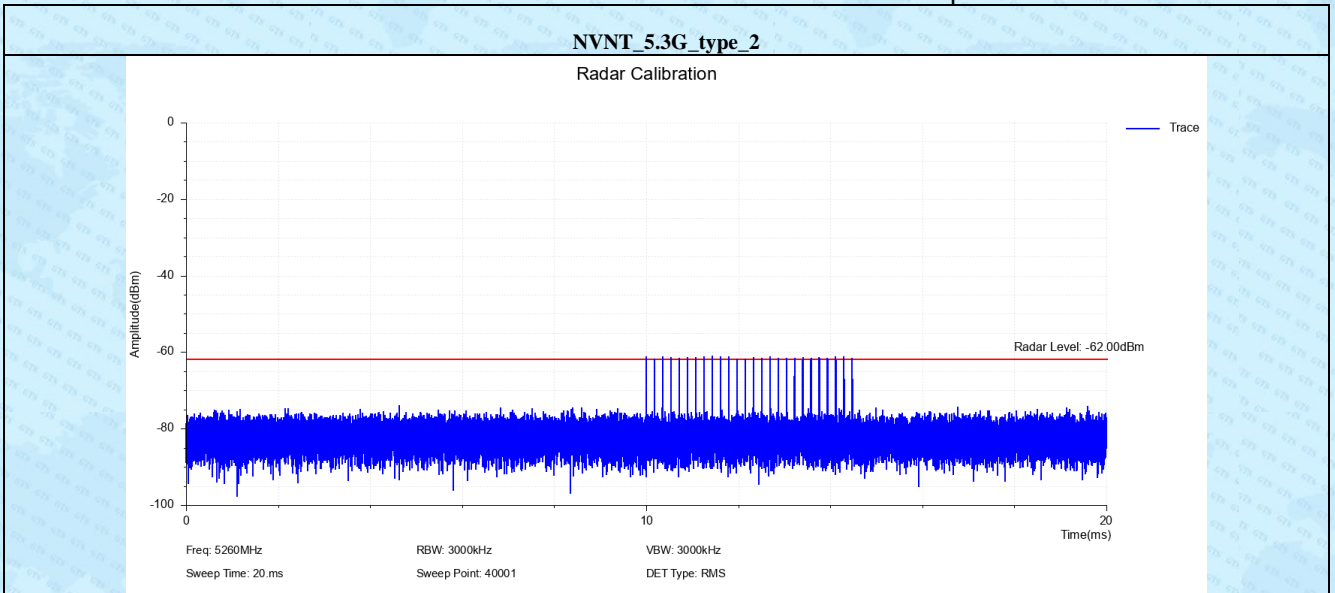

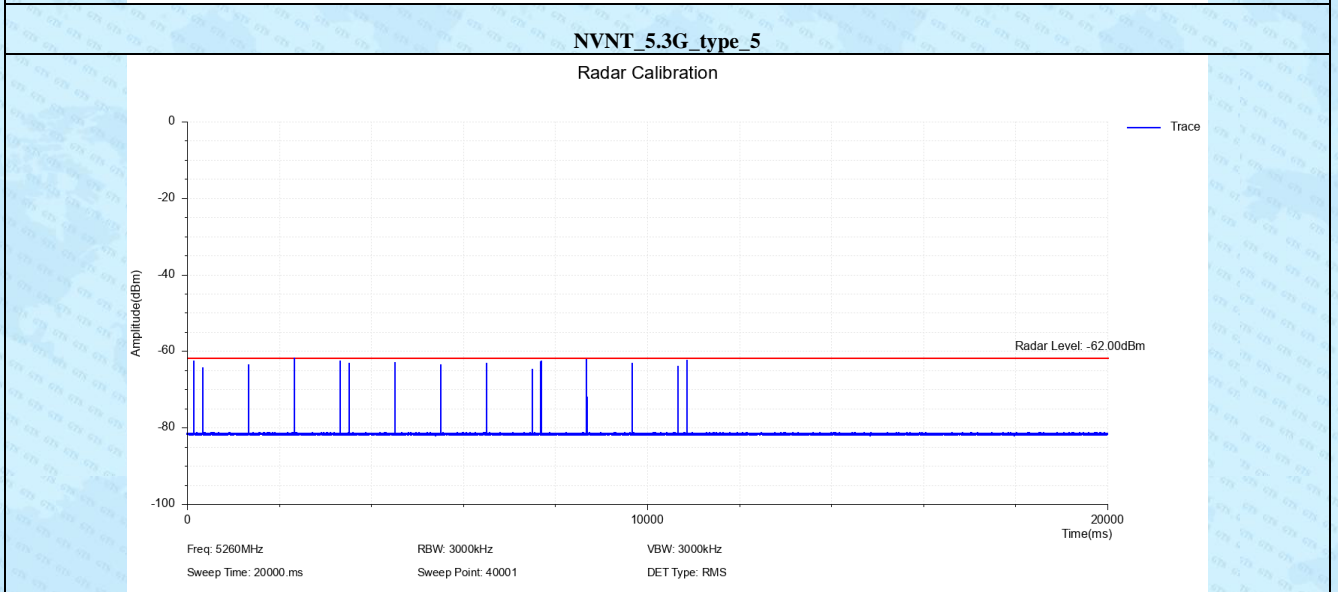
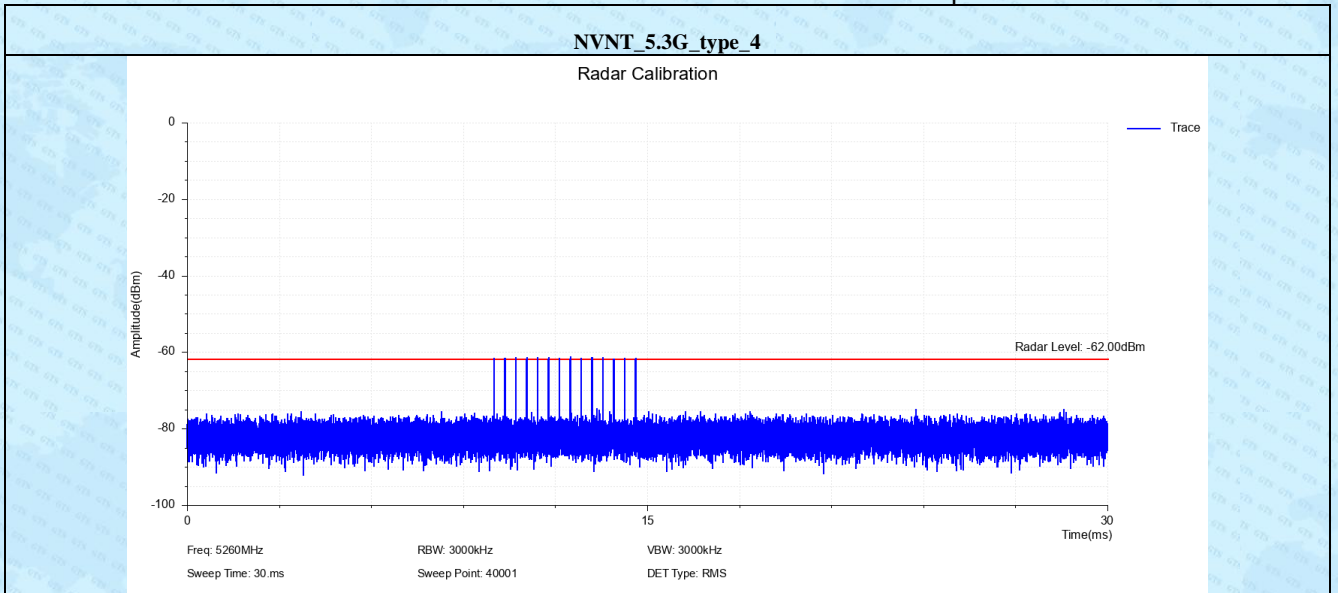

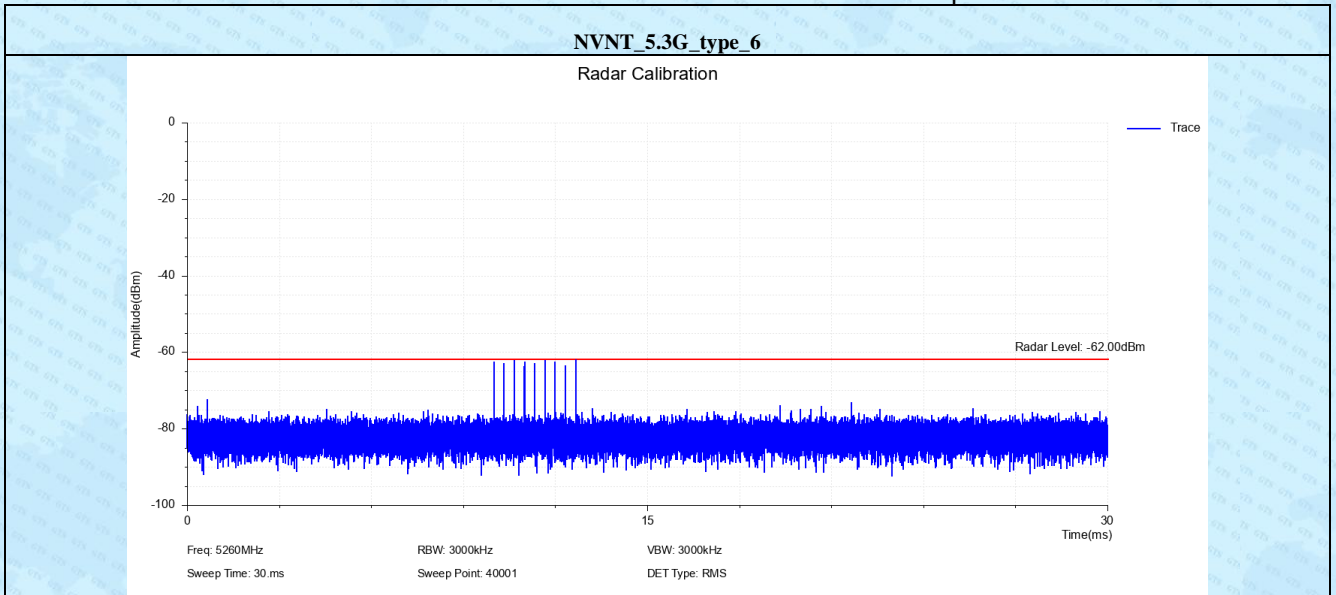

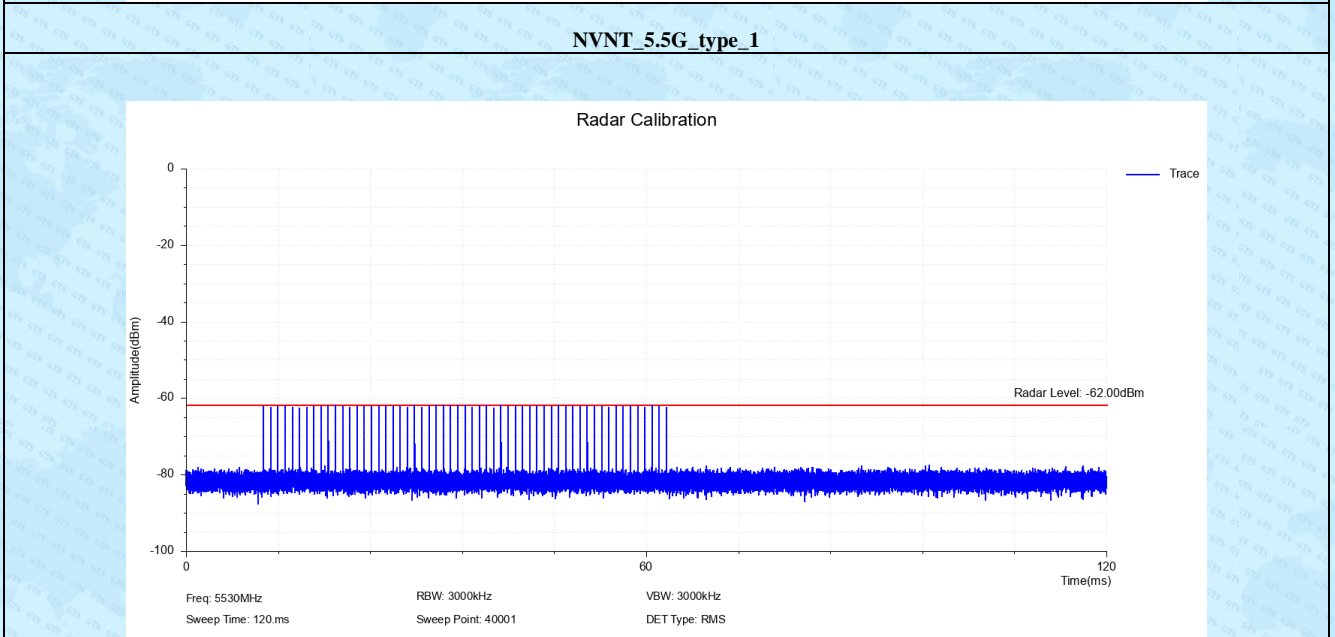
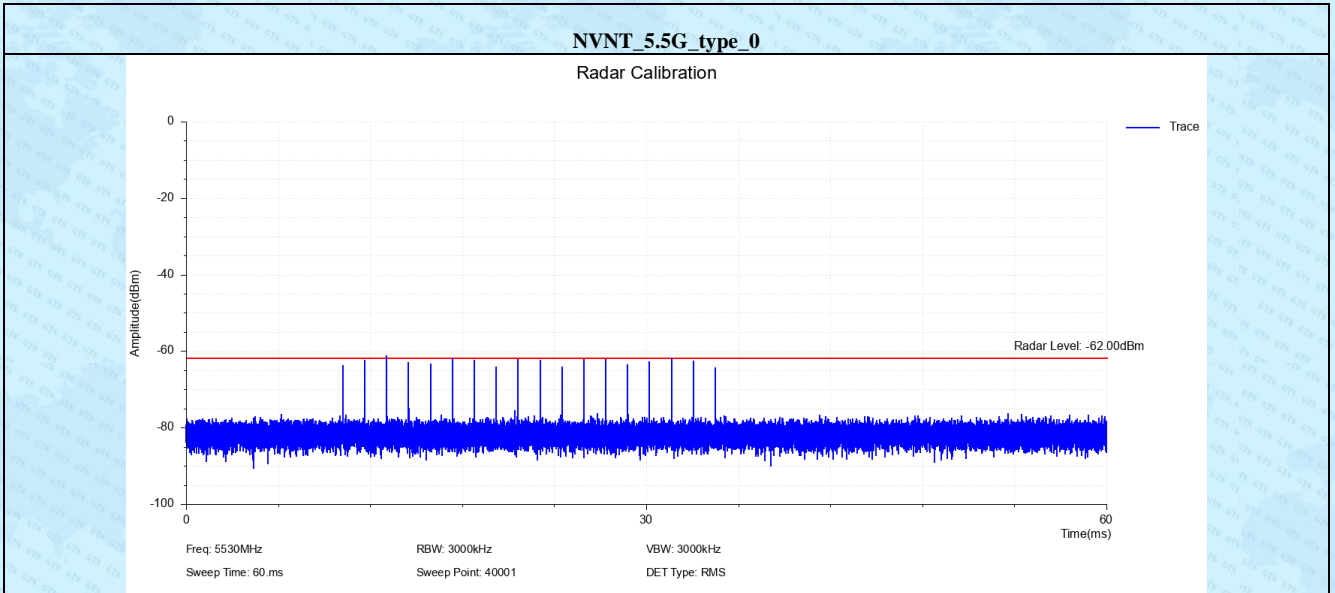

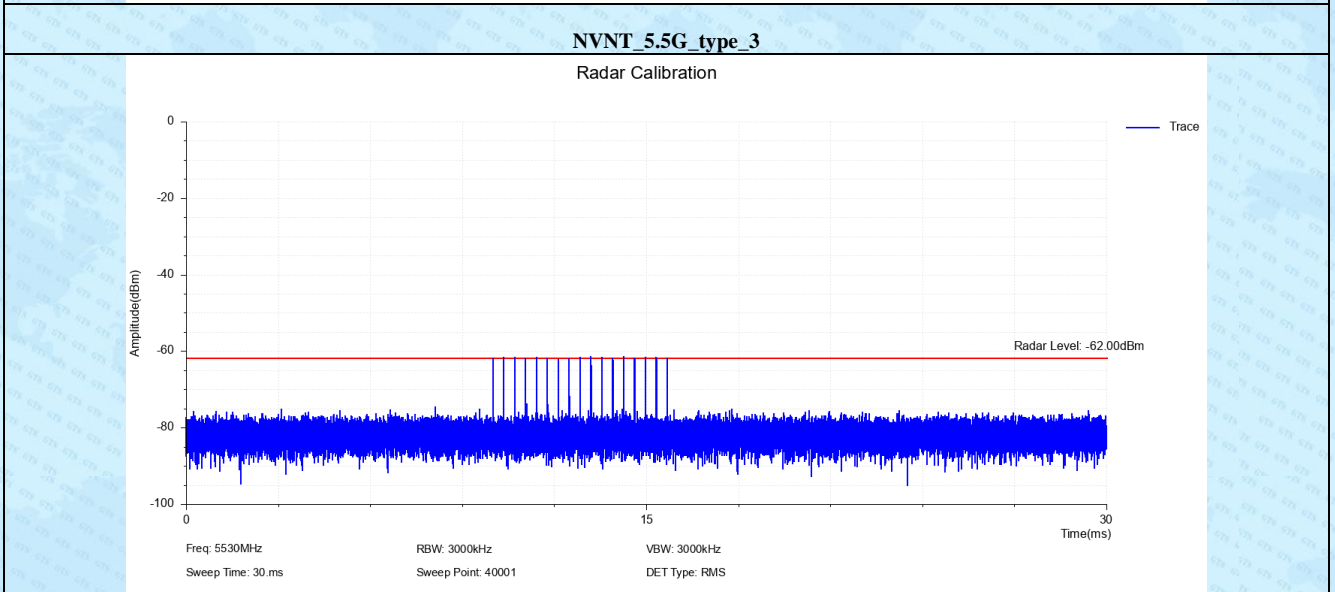
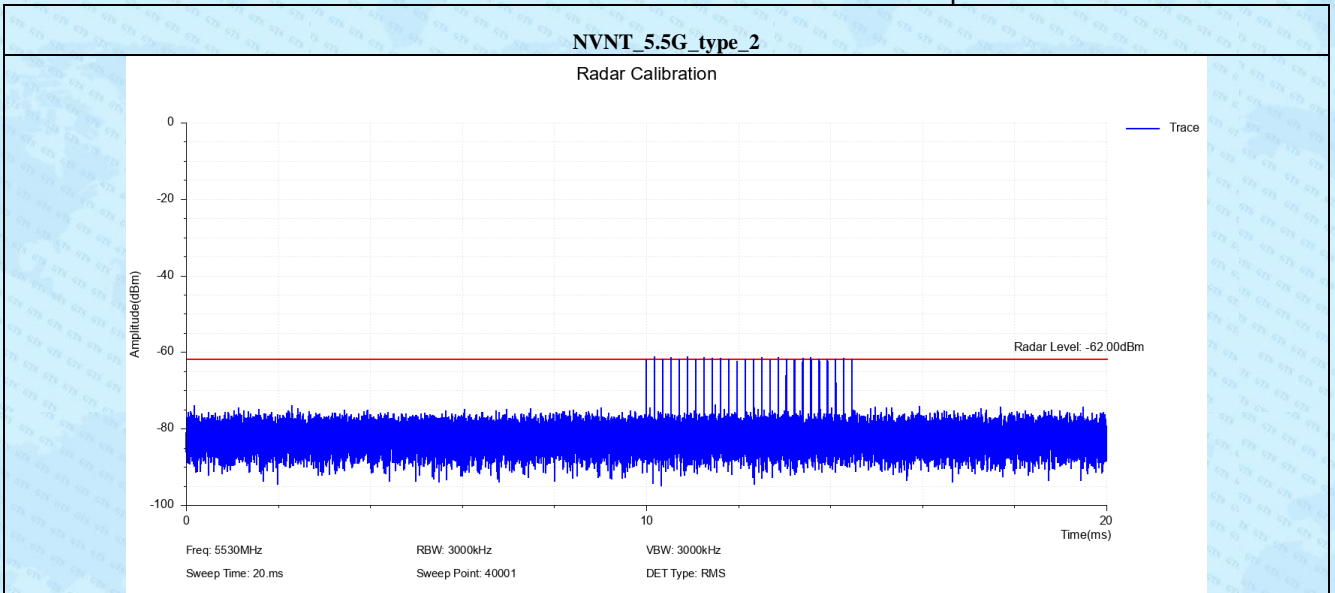

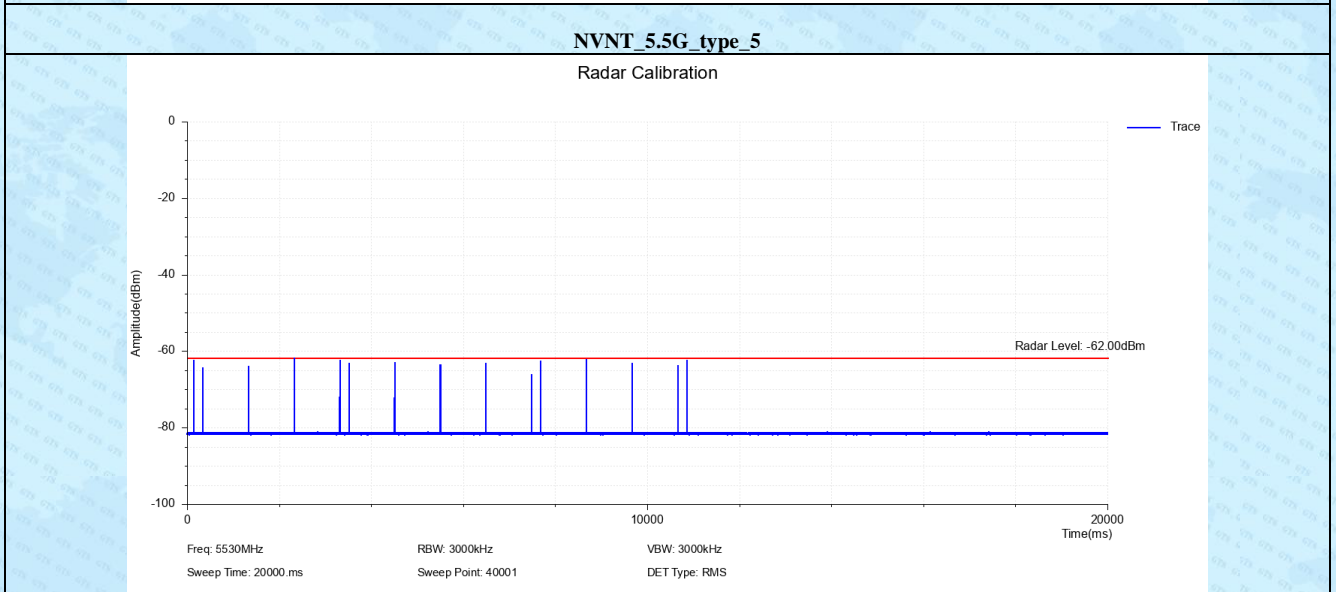
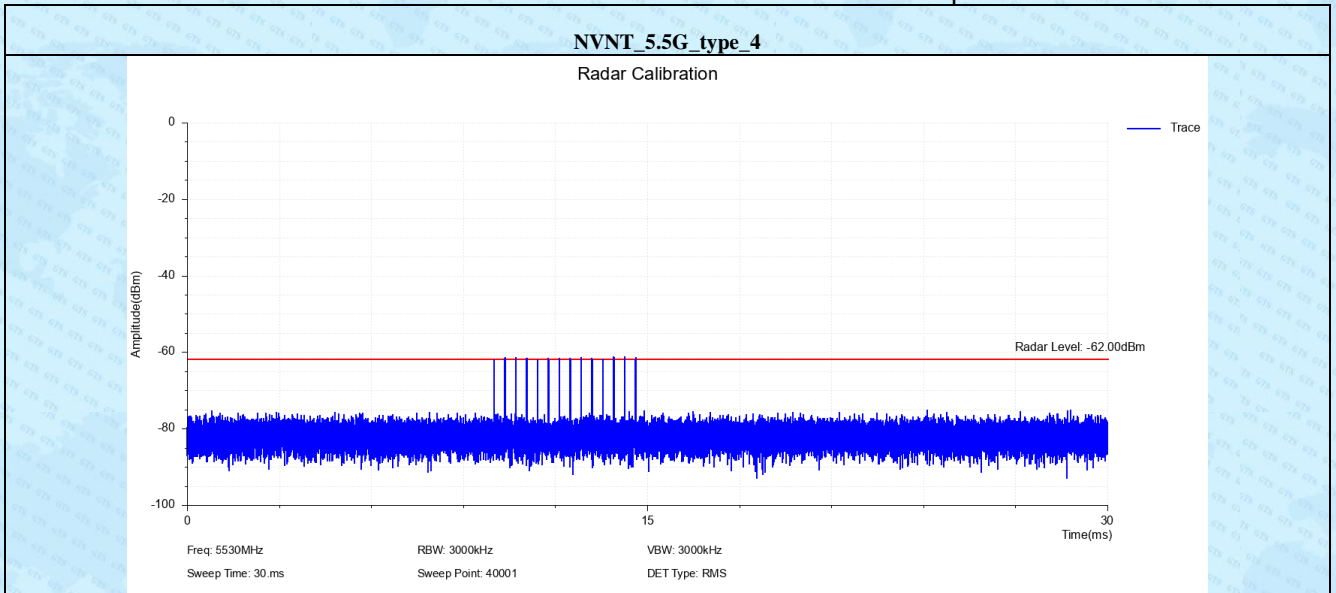

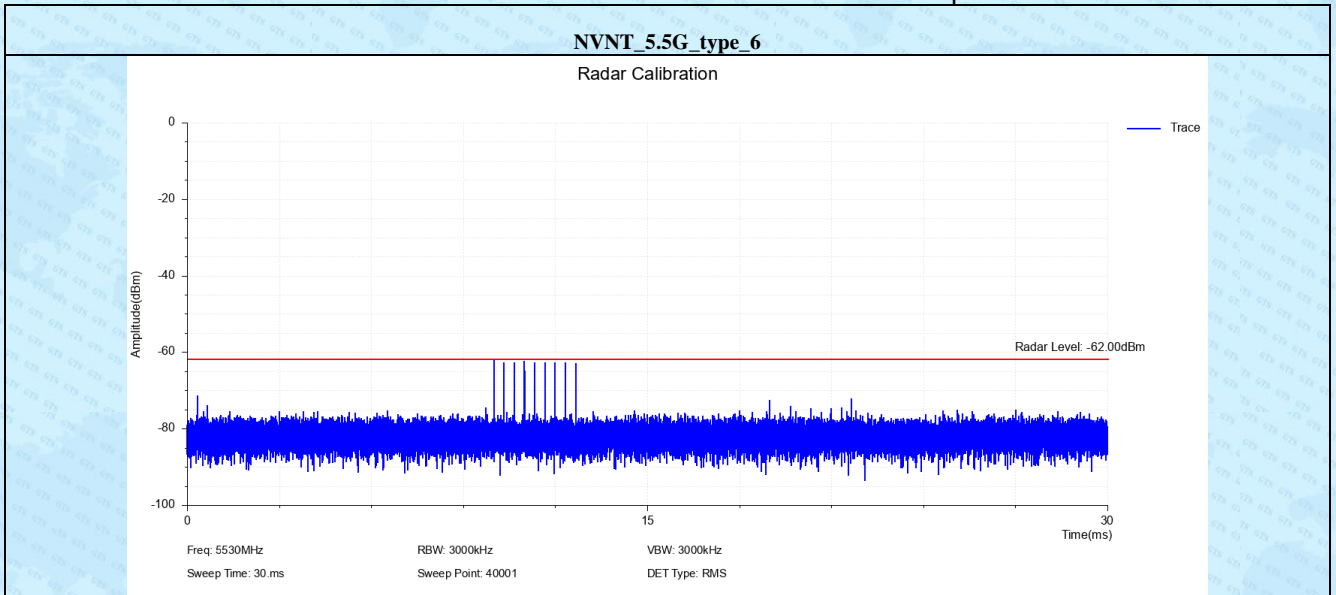

12.2 Channel Move Time and Channel Closing Transmission Time

Test Result

Channel Move Time and Channel Closing Transmission Time (Radar Type 0)

Test Frequency	Requirement	Measurement Level	Limit
5260MHz	Channel Closing Transmission Time	0.042	≤0.26s
	Channel Move Time	1.33	≤10s
5500MHz	Channel Closing Transmission Time	0.008	≤0.26s
	Channel Move Time	1.068	≤10s
5290MHz	Channel Closing Transmission Time	0.009	≤0.26s
	Channel Move Time	1.026	≤10s
5530MHz	Channel Closing Transmission Time	0.01	≤0.26s
	Channel Move Time	1.18	≤10s

Test Graphs

AX20-5260MHz(Radar Type 0)

Channel Shutdown

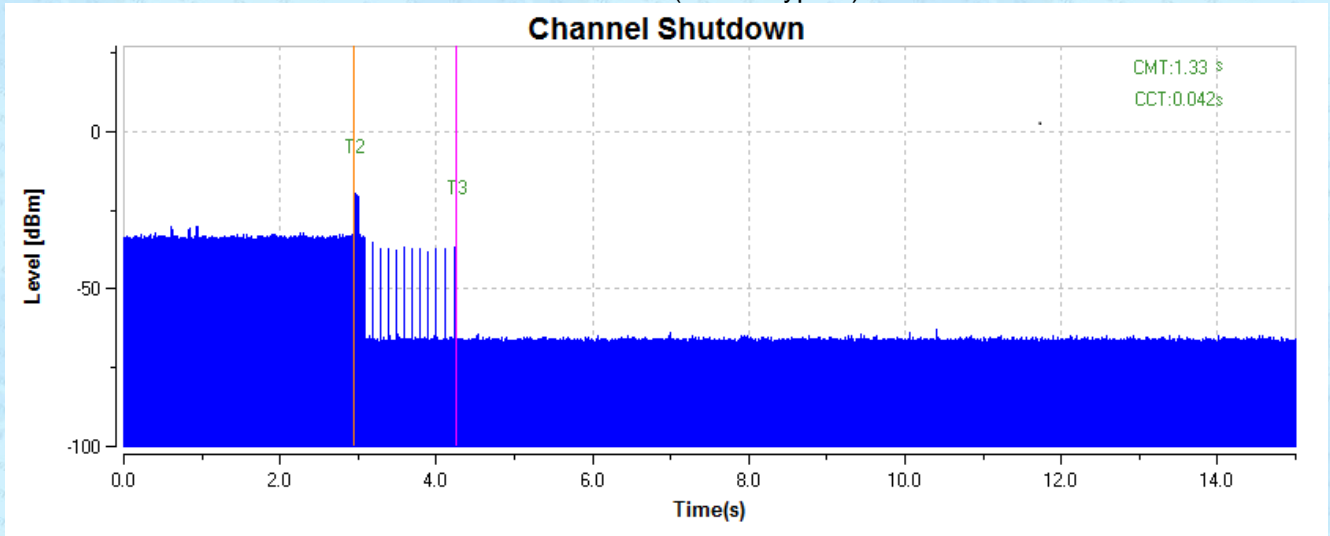

T0(S)	T1(S)	T2(S)	T3(S)
		2.944	4.275
Control Power Line		CMT 1.33	CCT 0.042

Note :

CMT: Channel Move Time

CCT: Channel Closing Transmission Time

T2 denote injected radar burst.

T3 denote Channel Move Time

AX20-5500MHz (Radar Type 0)

Channel Shutdown

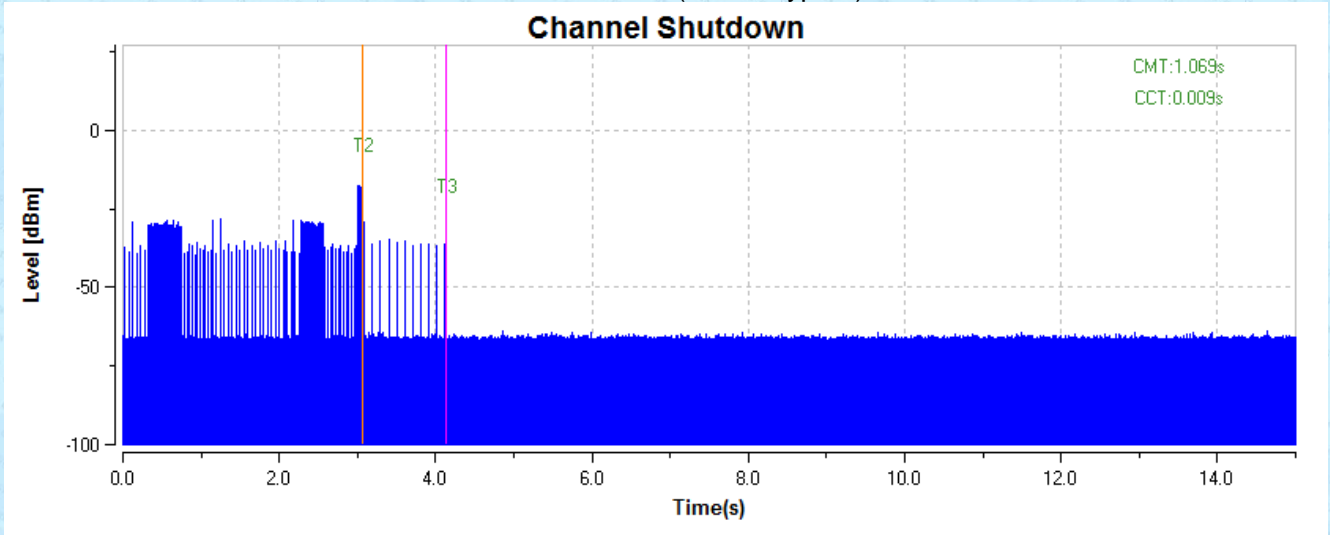

T0(S)	T1(S)	T2(S)	T3(S)
		3.065	4.174
Control Power Line		CMT 1.068	CCT 0.008

CMT: Channel Move Time

CCT: Channel Closing Transmission Time

T2 denote injected radar burst.

T3 denote Channel Move Time

AX80-5290MHz (Radar Type 0)

Channel Shutdown

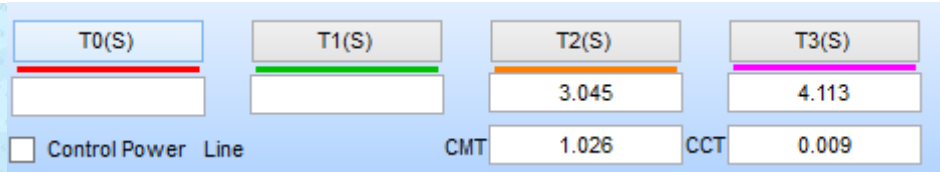
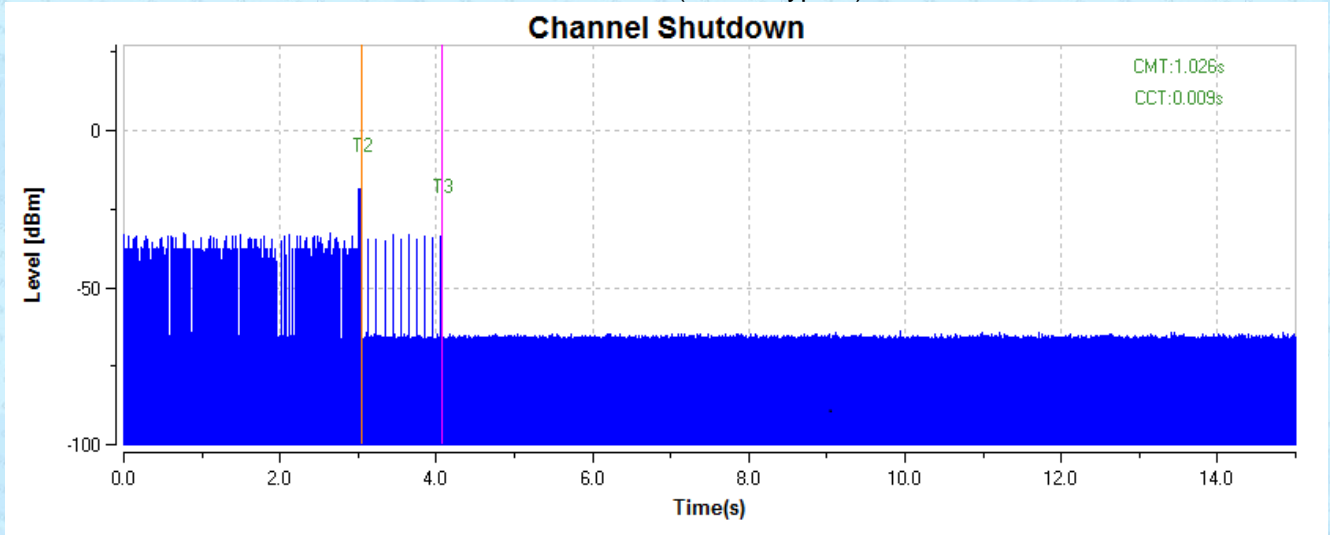

CMT: Channel Move Time

CCT: Channel Closing Transmission Time

T2 denote injected radar burst.

T3 denote Channel Move Time

AX80-5530MHz (Radar Type 0)

Channel Shutdown

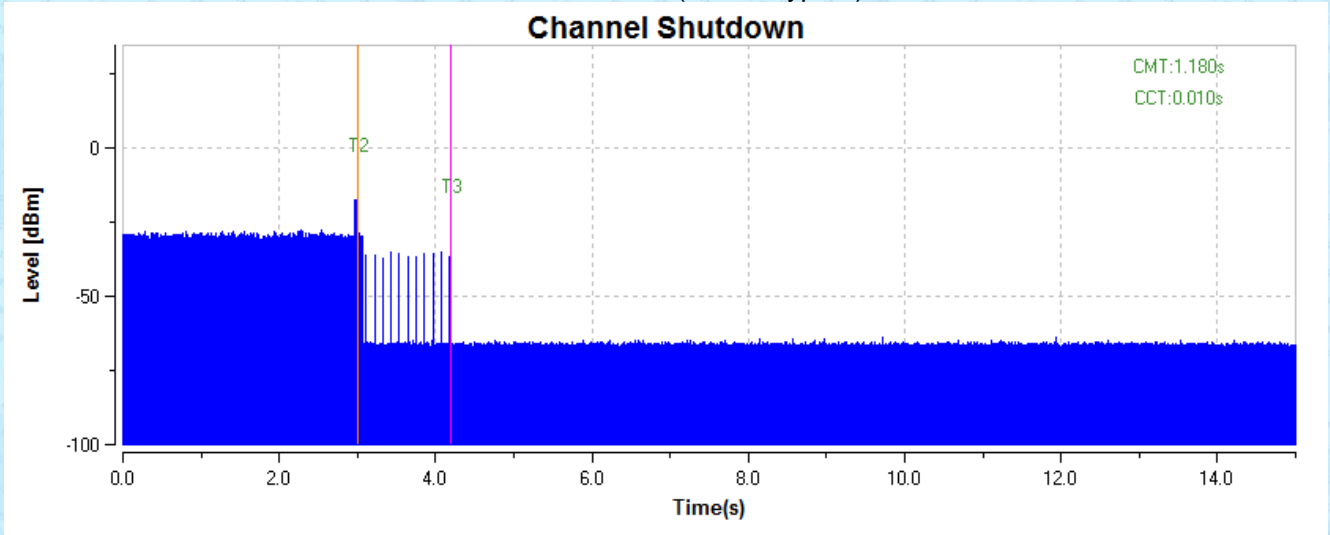

T0(S)	T1(S)	T2(S)	T3(S)
		3.004	4.234
<input type="checkbox"/> Control Power Line		CMT 1.180	CCT 0.010

CMT: Channel Move Time

CCT: Channel Closing Transmission Time

T2 denote injected radar burst.

T3 denote Channel Move Time

12.3 Non-Occupancy Period

Test Result

Test Graphs

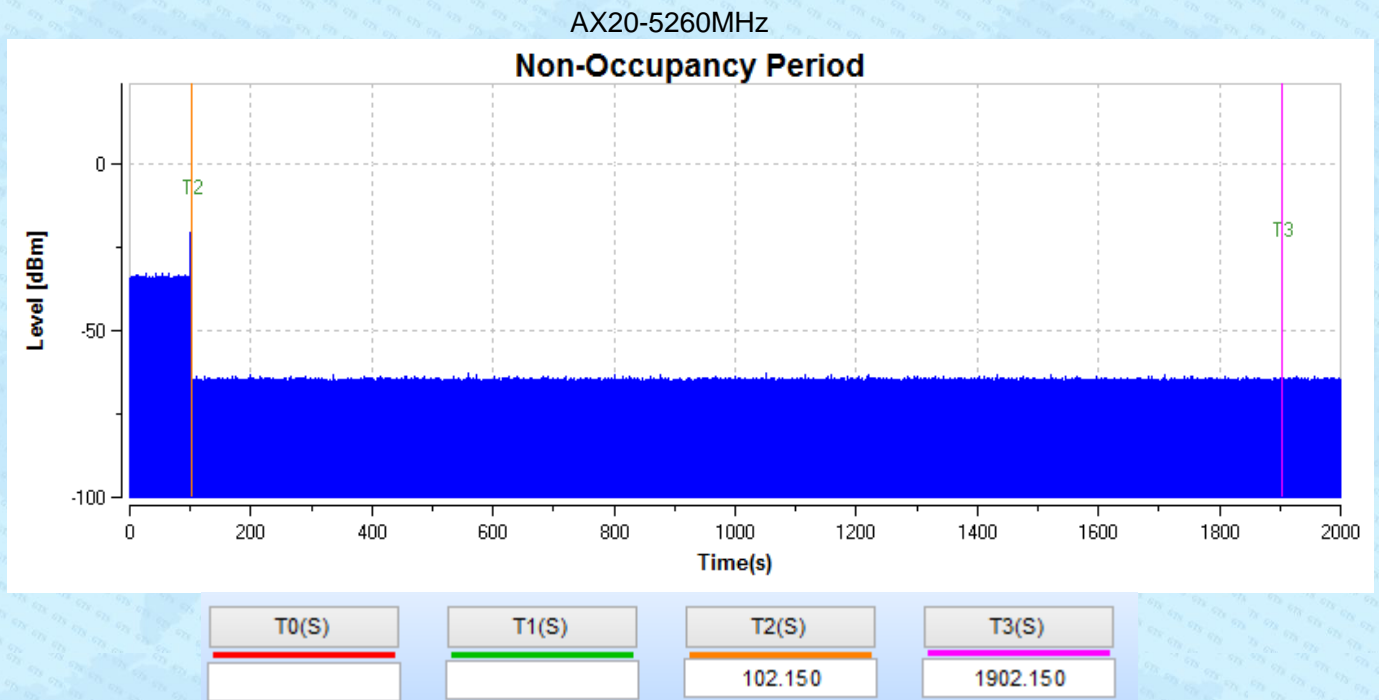

Note:

T3-T2 denotes Non-occupancy period

AX20-5500MHz

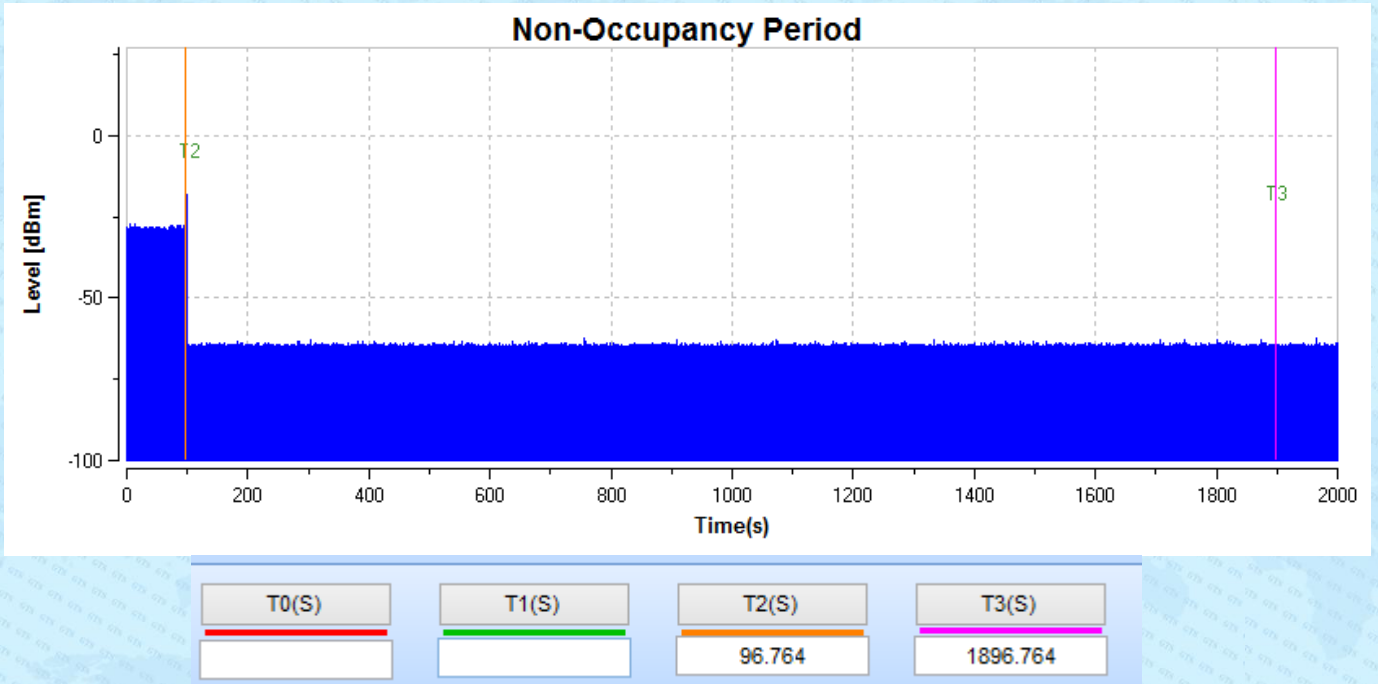

Note:

T3-T2 denotes Non-occupancy period

AX80-5290MHz

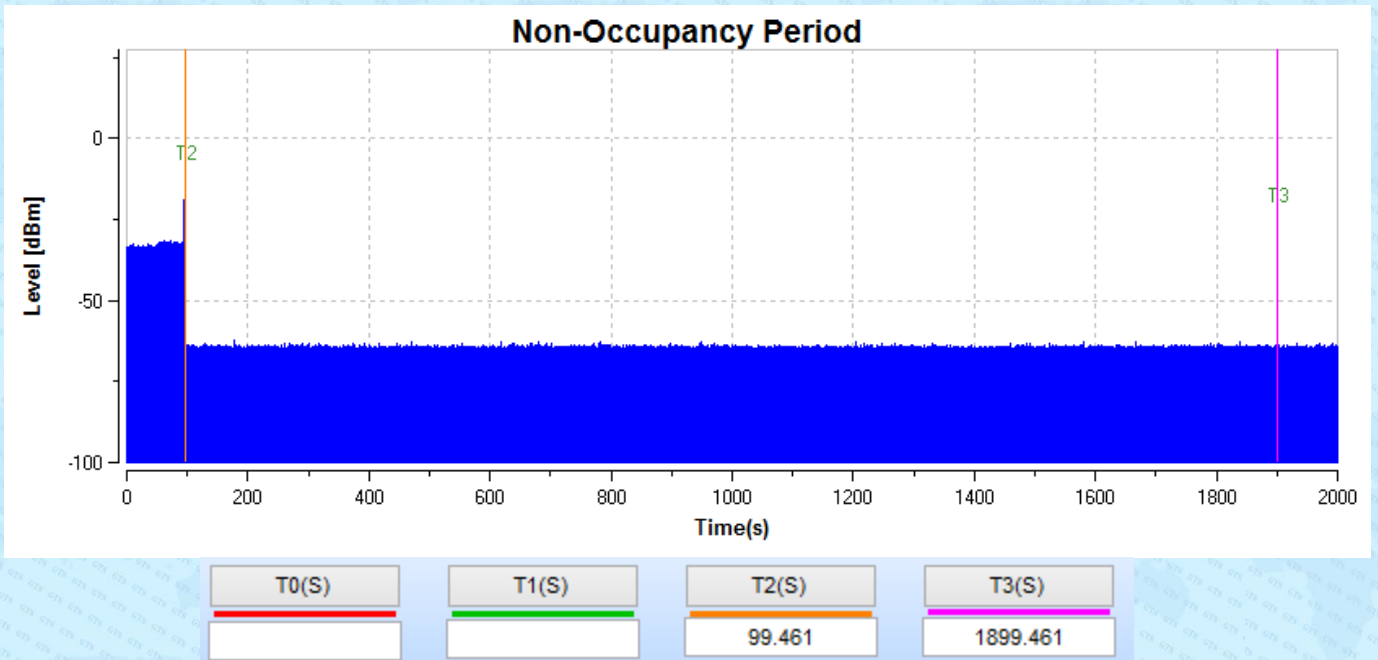

Note:

T3-T2 denotes Non-occupancy period

AX80-5530

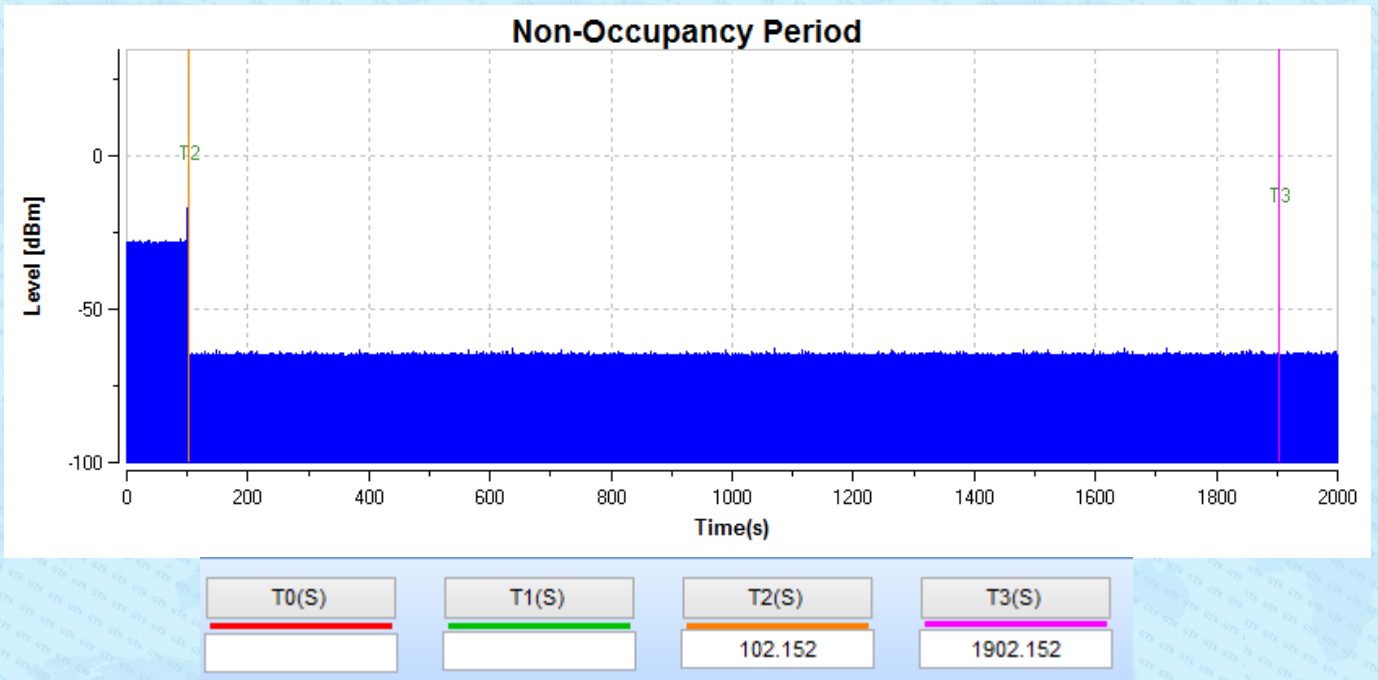

Note:

T3-T2 denotes Non-occupancy period

---End---