

Antenna Test Report

Tester: DAI

Date: 2019-4-19

Test items and equipment

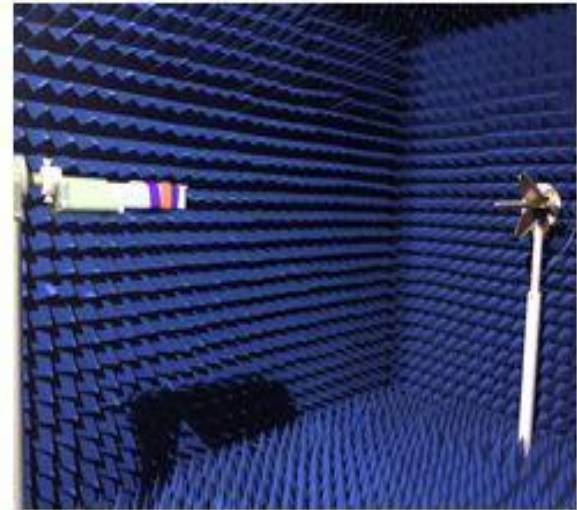

matching circuit

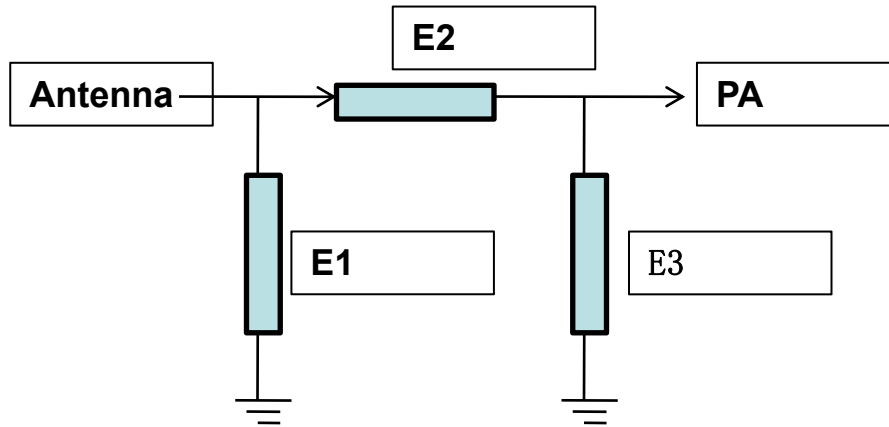

Element	Value
E1 (0201)	N/A
E2 (0201)	0欧姆
E3 (0201)	N/A

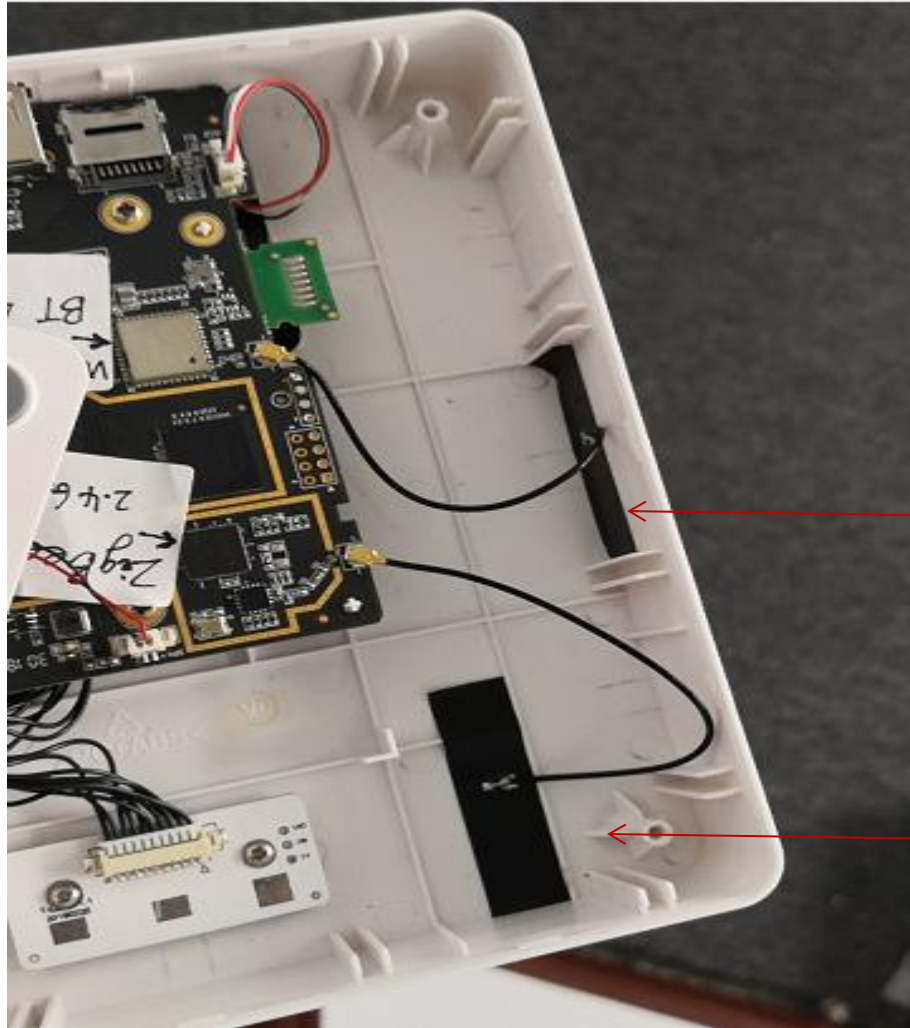

**ANT1(BT, 2.4
GWIFI)**

ANT2(Zigbee)

ANT1/2

Freq. (MHz)	2400	2410	2420	2430	2440	2450	2460	2470	2480	2490	2500
Peak Gain (dBi)	2.95	3.16	3.70	4.16	4.06	4.11	4.26	4.10	3.57	3.32	3.23
Efficiency(%)	42.0%	41.8%	45.6%	49.3%	47.7%	48.7%	52.8%	54.8%	53.5%	51.8%	51.8%
Everage Gain (dB)	-1.88	-1.68	-1.19	-0.70	-0.77	-0.79	-0.64	-0.74	-1.16	-1.27	-1.26

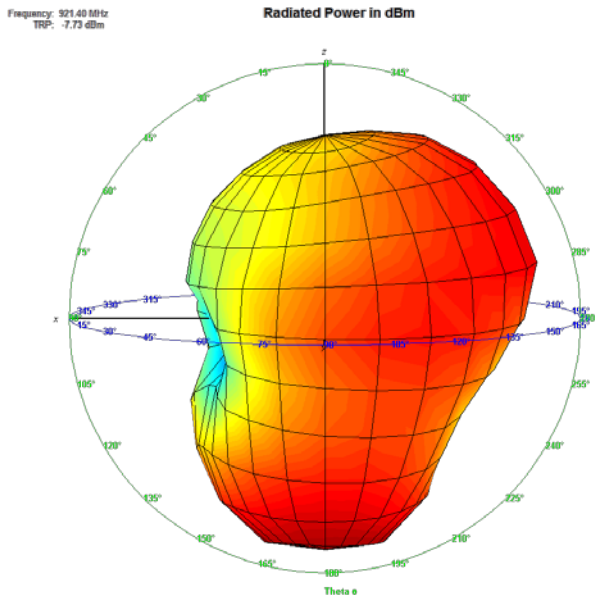

Figure 5.17: XZ plane (Y front view)

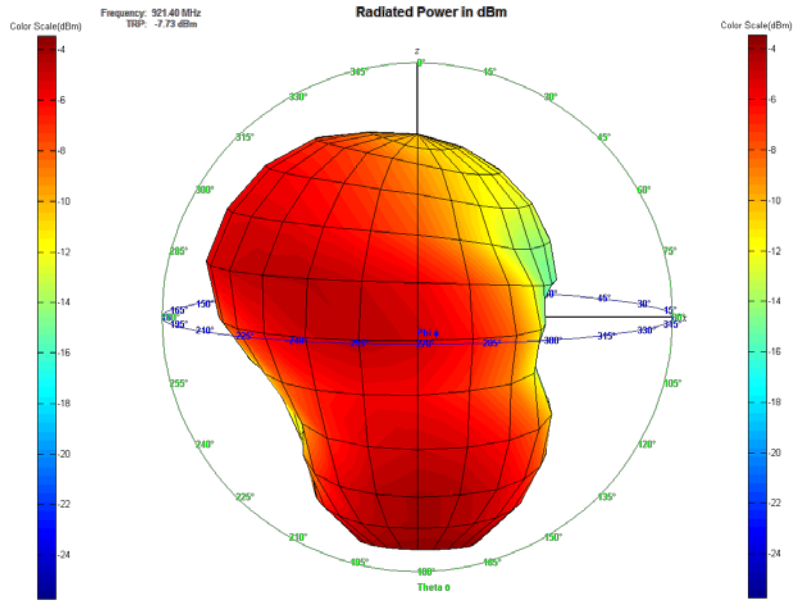

Figure 5.18: XZ plane (Y back view)

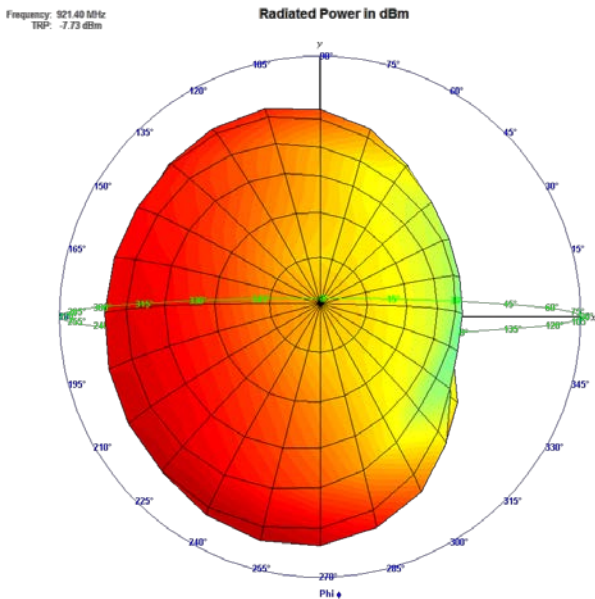

Figure 5.19: XY plane (Z front view)

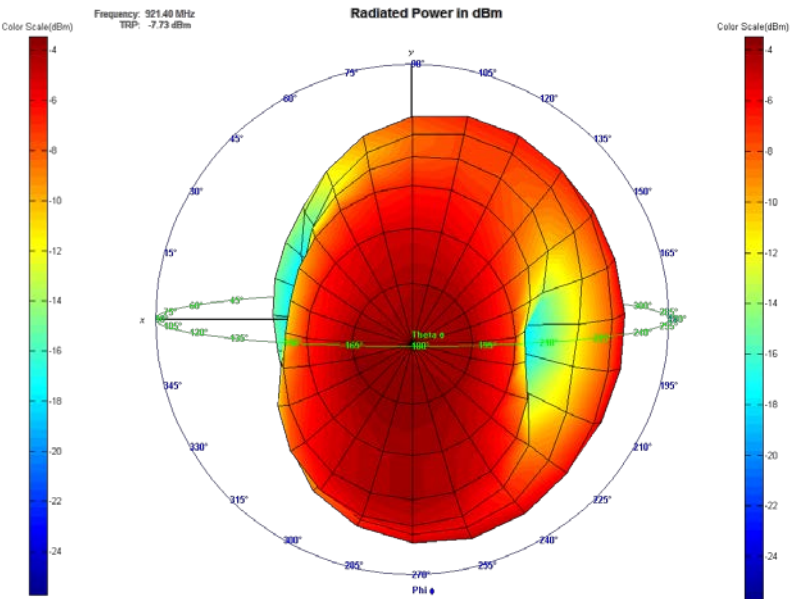

Figure 5.20: XY plane (Z back view)

5.9.2.1 REGION E

Table 5.20: Region E performance

Symbol	Description	Min	Typ	Max	Unit
f_c	Carrier frequency	-	868.40	-	MHz
TRP	Total radiated power	-	-3.05	-	dBm
ε_R	Radiation efficiency	-	-7.05	-	dB
D	Directivity	-	3.47	-	dBi
G	Peak gain	-	-3.58	-	dBi

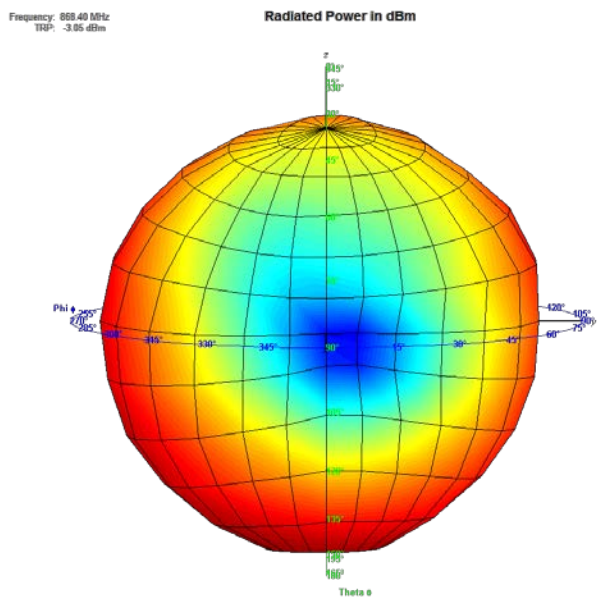

Figure 5.3: YZ plane (X front view)

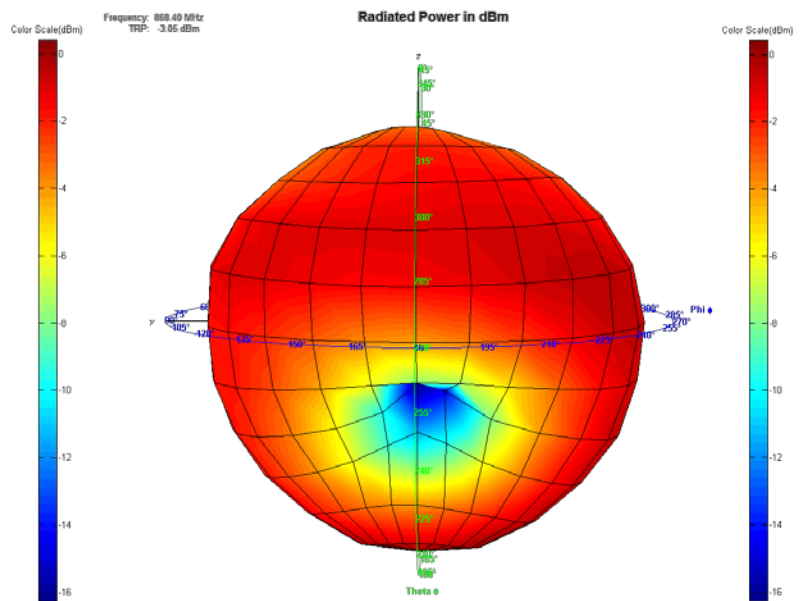
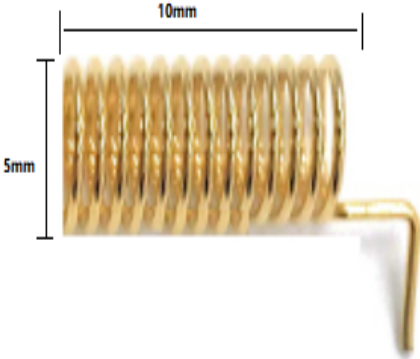

Figure 5.4: YZ plane (X back view)

Antenna picture:



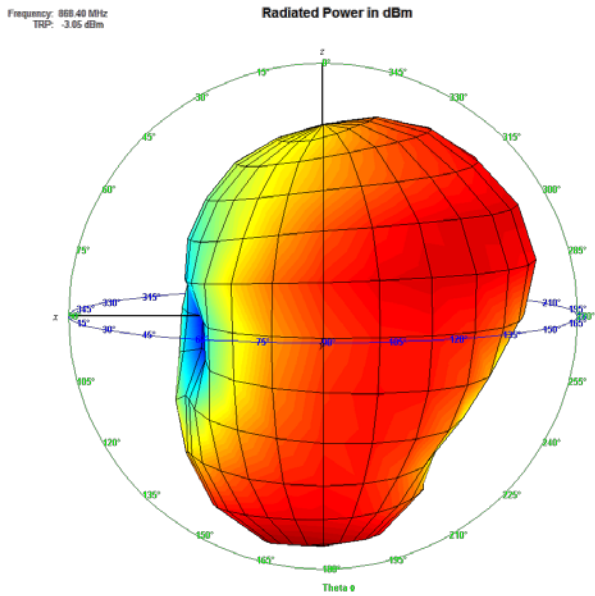

Figure 5.5: XZ plane (Y front view)

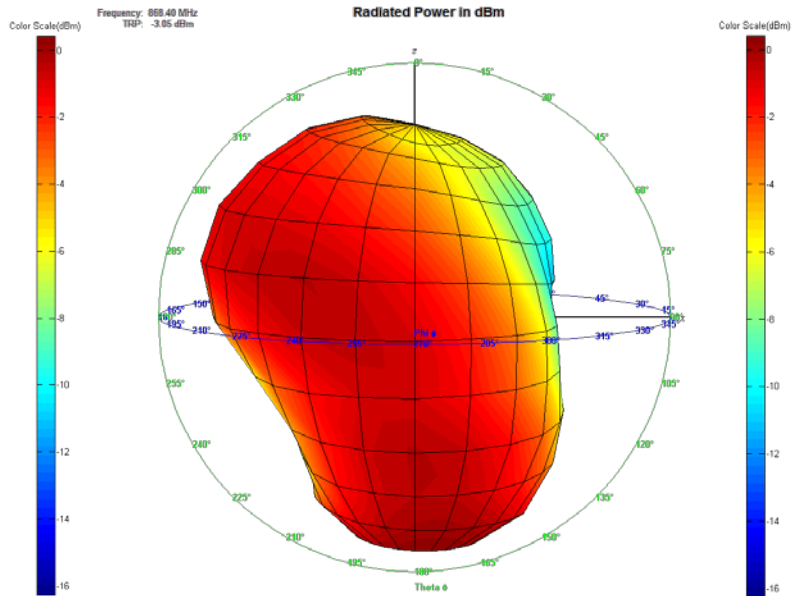

Figure 5.6: XZ plane (Y back view)

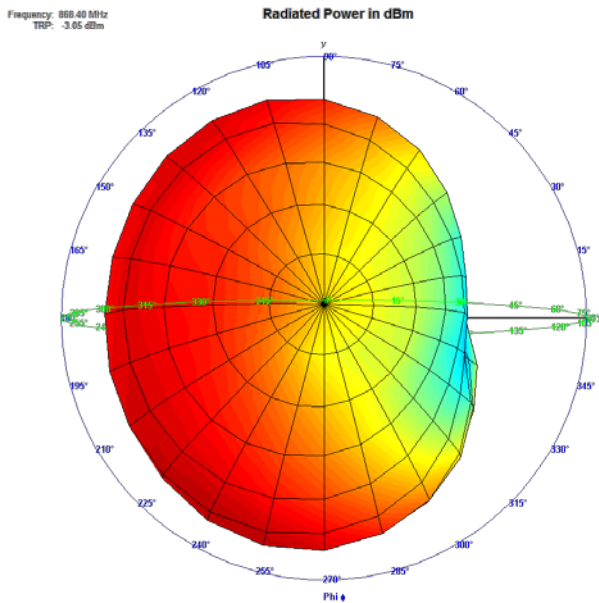

Figure 5.7: XY plane, (Z front view)

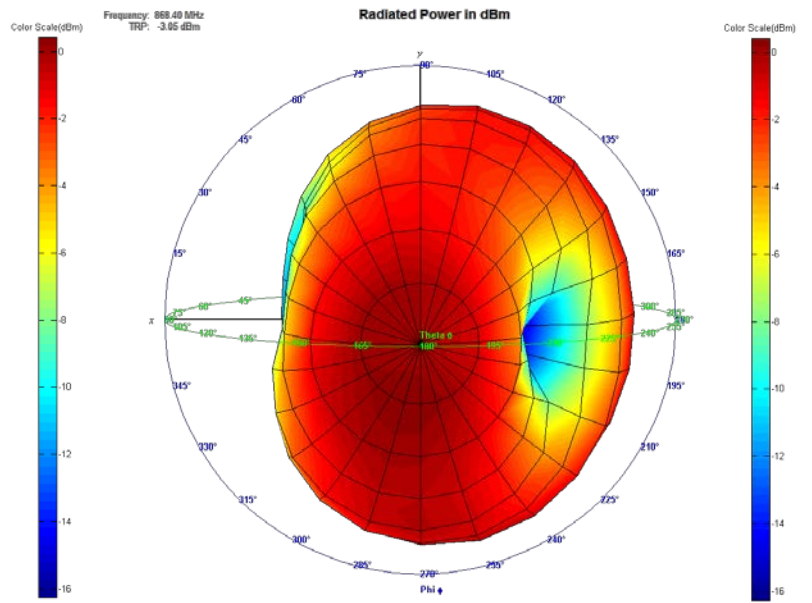

Figure 5.8: XY plane, (Z back view)

Thanks

