



TEST REPORT

FCC PART 15 SUBPART C 15.247

Test report

On Behalf of

Shenzhen Lanboxin Electronics&Technology Co., Ltd.

For

Bluetooth Mouse

Model No.: A28

FCC ID: 2A4WR-A28

Prepared for : Shenzhen Lanboxin Electronics&Technology Co., Ltd.
5F, Area D, E Project Hengbang Science Park, Shutianpu Community, Matian Street, Guangming District, Shenzhen, China

Prepared By : Shenzhen HUAK Testing Technology Co., Ltd.
1-2/F., Building B2, Junfeng Zhongcheng Zhizao Innovation Park, Heping, Fuhai Street, Bao'an District, Shenzhen, Guangdong, China

Date of Test: Feb. 15, 2022 ~ Feb. 23, 2022

Date of Report: Feb. 23, 2022

Report Number: HK2202210485-E

The results shown in this test report refer only to the sample(s) tested unless otherwise stated and the sample(s) are retained for 30 days only. The document is issued by HUAK, this document cannot be reproduced except in full with our prior written permission. The more details and the authenticity of the report will be confirmed at <http://www.cer-mark.com>.

HUAK Testing Lab TEL : +86-755 2302 9901 FAX : +86-755 2302 9901 E-mail : service@cer-mark.com

1-2/F., Building B2, Junfeng Zhongcheng Zhizao Innovation Park, Heping, Fuhai Street, Bao'an District, Shenzhen, Guangdong, China



TEST RESULT CERTIFICATION

Applicant’s name..... : Shenzhen Lanboxin Electronics&Technology Co., Ltd.
Address : 5F, Area D, E Project Hengbang Science Park, Shutianpu Community, Matian Street, Guangming District, Shenzhen, China

Manufacture's Name : Shenzhen Lanboxin Electronics&Technology Co., Ltd.
Address : 5F, Area D, E Project Hengbang Science Park, Shutianpu Community, Matian Street, Guangming District, Shenzhen, China

Product description

Trade Mark:

Product name..... : Bluetooth Mouse

Model and/or type reference ... : A28

Standards..... : 47 CFR FCC Part 15 Subpart C 15.247, C63.10:2013, KDB 558074
D01 15.247 Meas Guidance v05r02

This publication may be reproduced in whole or in part for non-commercial purposes as long as the Shenzhen HUAKE Testing Technology Co., Ltd. is acknowledged as copyright owner and source of the material. Shenzhen HUAKE Testing Technology Co., Ltd. takes no responsibility for and will not assume liability for damages resulting from the reader's interpretation of the reproduced material due to its placement and context.

Date of Test :
Date (s) of performance of tests..... : Feb. 15, 2022 ~ Feb. 23, 2022
Date of Issue : Feb. 23, 2022
Test Result..... : Pass

Prepared by: Yang Dian
Project Engineer

Reviewed by: Zden Hu
Project Supervisor

Approved by: Jason Zhou
Technical Director

The results shown in this test report refer only to the sample(s) tested unless otherwise stated and the sample(s) are retained for 30 days only. The document is issued by HUAKE, this document cannot be reproduced except in full with our prior written permission. The more details and the authenticity of the report will be confirmed at <http://www.cer-mark.com>.



Contents

	Page
CONTENTS	3
1 TEST SUMMARY	6
1.1 TEST DESCRIPTION.....	6
1.2 MEASUREMENT UNCERTAINTY.....	7
1.3 INFORMATION OF THE TEST LABORATORY	8
2 GENERAL INFORMATION	8
2.1 GENERAL DESCRIPTION OF EUT	8
2.2 DESCRIPTION OF TEST CONDITIONS	10
2.3 DESCRIPTION OF TEST SETUP	10
3 EQUIPMENTS LIST FOR ALL TEST ITEMS	11
4 TEST RESULT	13
4.1 ANTENNA REQUIREMENT.....	13
4.1.1 Standard requirement.....	13
4.1.2 EUT Antenna	13
4.2 CONDUCTION EMISSIONS MEASUREMENT	14
4.2.1 Applied procedures / Limit	14
4.2.2 Test procedure.....	14
4.2.3 Test setup	15
4.2.4 Test results	16
4.3 RADIATED EMISSIONS MEASUREMENT	18
4.3.1 Applied procedures / Limit	18
4.3.2 Test setup	18
4.3.3 Test Result.....	20
4.4 MAXIMUM OUTPUT POWER MEASUREMENT.....	28
4.4.1 Limit	28
4.4.2 Test procedure.....	28
4.4.3 Deviation from standard.....	28
4.4.4 Test setup	28
4.4.5 Test results	28
4.5 POWER SPECTRAL DENSITY.....	29
4.5.1 Limit	29
4.5.2 Test procedure.....	29
4.5.3 Deviation from standard.....	29
4.5.4 Test setup	29
4.5.5 Test results	30

The results shown in this test report refer only to the sample(s) tested unless otherwise stated and the sample(s) are retained for 30 days only. The document is issued by HUAKE, this document cannot be reproduced except in full with our prior written permission. The more details and the authenticity of the report will be confirmed at <http://www.cer-mark.com>.



4.6 6dB BANDWIDTH 32

4.6.1 Limit 32

4.6.2 Test procedure..... 32

4.6.3 Deviation from standard..... 32

4.6.4 Test setup 32

4.6.5 Test result 32

4.7 OCCUPIED BANDWIDTH 35

4.7.1 Test procedure..... 35

4.7.2 Deviation from standard..... 35

4.7.3 Test setup 35

4.7.4 Test result 35

4.8 BAND EDGE 36

4.8.1 Limit 36

4.8.2 Test procedure..... 36

4.8.3 Deviation from standard..... 36

4.8.4 Test setup 36

4.8.5 Test results 37

4.9 CONDUCTED SPURIOUS EMISSIONS 38

4.9.1 Applied procedures / Limit 38

4.9.2 Test procedure..... 38

4.9.3 Deviation from standard..... 38

4.9.4 Test setup 38

4.9.5 Test results 39

5 TEST SETUP PHOTO 42

6 PHOTOS OF THE EUT 44

The results shown in this test report refer only to the sample(s) tested unless otherwise stated and the sample(s) are retained for 30 days only. The document is issued by HUAK, this document cannot be reproduced except in full with our prior written permission. The more details and the authenticity of the report will be confirmed at <http://www.cer-mark.com>.



Revision History

Revision	Issue Date	Description	Revised By
V1.0	Feb. 23, 2022	Initial Issue	Jason Zhou

The results shown in this test report refer only to the sample(s) tested unless otherwise stated and the sample(s) are retained for 30 days only. The document is issued by HUAK, this document cannot be reproduced except in full with our prior written permission. The more details and the authenticity of the report will be confirmed at <http://www.cer-mark.com>.

HUAK Testing Lab TEL : +86-755 2302 9901 FAX : +86-755 2302 9901 E-mail : service@cer-mark.com

1-2/F., Building B2, Junfeng Zhongcheng Zhizao Innovation Park, Heping, Fuhai Street, Bao'an District, Shenzhen, Guangdong, China



1 Test Summary

1.1 Test Description

Test Item	Test Requirement	Result
Antenna Requirement	§15.203/§15.247(b)(4)	PASS
Conducted Emission	FCC Part 15.207	PASS
Radiated Emissions	FCC Part 15.205/15.209	PASS
Maximum Peak Output Power	FCC Part 15.247(b)	PASS
Power Spectral Density	FCC Part 15.247 (e)	PASS
6dB Bandwidth & 99% Bandwidth	FCC Part 15.247(a)(2)	PASS
Spurious RF Conducted Emission	FCC Part 15.247(d)	PASS
Band Edge	FCC Part 15.247(d)	PASS

The results shown in this test report refer only to the sample(s) tested unless otherwise stated and the sample(s) are retained for 30 days only. The document is issued by HUAK, this document cannot be reproduced except in full with our prior written permission. The more details and the authenticity of the report will be confirmed at <http://www.cer-mark.com>.

HUAK Testing Lab TEL : +86-755 2302 9901 FAX : +86-755 2302 9901 E-mail : service@cer-mark.com

1-2/F., Building B2, Junfeng Zhongcheng Zhizao Innovation Park, Heping, Fuhai Street, Bao'an District, Shenzhen, Guangdong, China



1.2 Measurement Uncertainty

All measurements involve certain levels of uncertainties. The data and results referenced in this document are true and accurate. The reader is cautioned that there may be errors within the calibration limits of the equipment and facilities. The measurement uncertainty was calculated for all measurements listed in this test report acc. To CISPR 16 – 4 “Specification for radio disturbance and immunity measuring apparatus and methods – Part 4: Uncertainty in EMC Measurements” and is documented in the LCS quality system acc. To DIN EN ISO/IEC 17025. Furthermore, component and process variability of devices similar to that tested may result in additional deviation. The manufacturer has the sole responsibility of continued compliance of the device. The maximum value of the uncertainty as below:

No.	Item	Uncertainty
1	Conducted Emission Test	$\pm 2.71\text{dB}$
2	All emissions, radiated(<1G)	$\pm 3.90\text{dB}$
3	All emissions, radiated(>1G)	$\pm 4.28\text{dB}$



1.3 Information of the Test Laboratory

Shenzhen HUAK Testing Technology Co., Ltd.
Add.: 1-2/F., Building B2, Junfeng Zhongcheng Zhizao Innovation Park, Heping, Fuhai Street, Bao'an District, Shenzhen, Guangdong, China

Testing Laboratory Authorization:

A2LA Accreditation Code is 4781.01.

FCC Designation Number is CN1229.

Canada IC CAB identifier is CN0045.

CNAS Registration Number is L9589.

2 General Information

2.1 General Description of EUT

Manufacturer:	Shenzhen Lanboxin Electronics&Technology Co., Ltd.
Manufacturer Address:	5F, Area D, E Project Hengbang Science Park, Shutianpu Community, Matian Street, Guangming District, Shenzhen, China
EUT Name:	Bluetooth Mouse
Model No:	A28
Series Models:	N/A
Model Difference:	N/A
Brand Name:	N/A
Operation frequency:	2402 MHz to 2480 MHz
Channel separation:	2MHz
NUMBER OF CHANNEL:	40
Modulation Technology:	GFSK
Hardware Version:	V1.0
Software Version:	V1.0
Antenna Type:	PCB Antenna
Antenna Gain:	2.34dBi
Power Supply:	DC 5V from micro USB or DC 3.7V from battery
Note:	1.For a more detailed features description, please refer to the manufacturer's specifications or the User's Manual.



Description of Channel:					
Channel	Frequency (MHz)	Channel	Frequency (MHz)	Channel	Frequency (MHz)
0	2402	14	2430	28	2458
1	2404	15	2432	29	2460
2	2406	16	2434	30	2462
3	2408	17	2436	31	2464
4	2410	18	2438	32	2466
5	2412	19	2440	33	2468
6	2414	20	2442	34	2470
7	2416	21	2444	35	2472
8	2418	22	2446	36	2474
9	2420	23	2448	37	2476
10	2422	24	2450	38	2478
11	2424	25	2452	39	2480
12	2426	26	2454		
13	2428	27	2456		

The results shown in this test report refer only to the sample(s) tested unless otherwise stated and the sample(s) are retained for 30 days only. The document is issued by HUAK, this document cannot be reproduced except in full with our prior written permission. The more details and the authenticity of the report will be confirmed at <http://www.cer-mark.com>.



2.2 Description of Test conditions

(1) E.U.T. test conditions:

For intentional radiators, measurements of the variation of the input power or the radiated signal level of the fundamental frequency component of the emission, as appropriate, shall be performed with the supply voltage varied between 85% and 115% of the nominal rated supply voltage. For battery operated equipment, the equipment tests shall be performed using a new battery.

(2) Frequency range of radiated measurements:

The test range will be up to the tenth harmonic of the highest fundamental frequency.

(3) Pre-test the EUT in all transmitting mode at the lowest (2402 MHz), middle (2440 MHz) and highest (2480 MHz) channel with different data packet and conducted to determine the worst-case mode,

only the worst-case results are recorded in this report.

(4) The EUT was programmed to be in continuously transmitting mode and the transmit duty cycle is not less than 98%.

2.3 DESCRIPTION OF TEST SETUP

Operation of EUT during conducted testing and radiation below 1GHz testing:

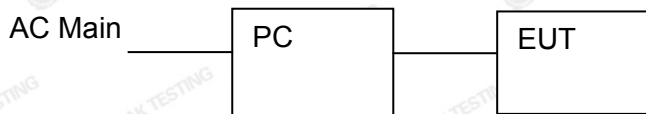

Operation of EUT during Above1GHz Radiation testing:

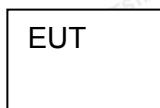

- PC information
 Model: TP00067A
 Input: DC20V, 2.25-3.25A
 Output: 5VDC, 0.5A

The sample was placed (0.8m below 1GHz, 1.5m above 1GHz) above the ground plane of 3m chamber. Measurements in both horizontal and vertical polarities were performed. During the test, each emission was maximized by: having the EUT continuously working, investigated all operating modes, rotated about all 3 axis (X, Y & Z) and considered typical configuration to obtain worst position, manipulating interconnecting cables, rotating the turntable, varying antenna height from 1m to 4m in both horizontal and vertical polarizations. The emissions worst-case are shown in Test Results of the following pages. The worst case is X position.



3 Equipments List for All Test Items

Item	Equipment	Manufacturer	Model No.	Serial No.	Last Cal.	Cal. Interval
1.	L.I.S.N. Artificial Mains Network	R&S	ENV216	HKE-002	Dec. 09, 2021	1 Year
2.	L.I.S.N.	R&S	ENV216	HKE-059	Dec. 09, 2021	1 Year
3.	Receiver	R&S	ESCI 7	HKE-010	Dec. 09, 2021	1 Year
4.	RF automatic control unit	Tonscend	JS0806-2	HKE-060	Dec. 09, 2021	1 Year
5.	Spectrum analyzer	R&S	FSP40	HKE-025	Dec. 09, 2021	1 Year
6.	Spectrum analyzer	Agilent	N9020A	HKE-048	Dec. 09, 2021	1 Year
7.	High gain antenna	Schwarzbeck	LB-180400KF	HKE-054	Dec. 09, 2021	1 Year
8.	Preamplifier	Schwarzbeck	BBV 9743	HKE-006	Dec. 09, 2021	1 Year
9.	Bilog Broadband Antenna	Schwarzbeck	VULB9163	HKE-012	Dec. 09, 2021	1 Year
10.	Loop Antenna	Schwarzbeck	FMZB 1519 B	HKE-014	Dec. 09, 2021	1 Year
11.	Horn Antenna	Schwarzbeck	9120D	HKE-013	Dec. 09, 2021	1 Year
12.	Pre-amplifier	EMCI	EMC051845SE	HKE-015	Dec. 09, 2021	1 Year
13.	Pre-amplifier	Agilent	83051A	HKE-016	Dec. 09, 2021	1 Year
14.	High pass filter unit	Tonscend	JS0806-F	HKE-055	Dec. 09, 2021	1 Year
15.	Conducted test software	Tonscend	TS+ Rev 2.5.0.0	HKE-081	N/A	N/A
16.	Radiated test software	Tonscend	TS+ Rev 2.5.0.0	HKE-082	N/A	N/A
17.	RF test software	Tonscend	JS1120-B Version 2.6	HKE-083	N/A	N/A
18.	RF automatic control unit	Tonscend	JS0806-2	HKE-060	Dec. 09, 2021	3 Year
19.	RF test software	Tonscend	JS1120-4	HKE-113	N/A	N/A
20.	RF test software	Tonscend	JS1120-3	HKE-114	N/A	N/A
21.	RF test software	Tonscend	JS1120-1	HKE-115	N/A	N/A
22.	Spectrum analyzer	Agilent	N9020A	HKE-048	Dec. 09, 2021	1 Year
23.	Signal generator	Agilent	N5182A	HKE-029	Dec. 09, 2021	1 Year
24.	Signal Generator	Agilent	83630A	HKE-028	Dec. 09, 2021	1 Year
25.	Power meter	Agilent	E4419B	HKE-085	Dec. 09, 2021	1 Year
26.	Power Sensor	Agilent	E9300A	HKE-086	Dec. 09, 2021	1 Year

The results shown in this test report refer only to the sample(s) tested unless otherwise stated and the sample(s) are retained for 30 days only. The document is issued by HUAKE, this document cannot be reproduced except in full with our prior written permission. The more details and the authenticity of the report will be confirmed at <http://www.cer-mark.com>.

HUAKE Testing Lab TEL : +86-755 2302 9901 FAX : +86-755 2302 9901 E-mail : service@cer-mark.com

1-2/F., Building B2, Junfeng Zhongcheng Zhizao Innovation Park, Heping, Fuhai Street, Bao'an District, Shenzhen, Guangdong, China



27	RF Cable(below1GHz)	Times	9kHz-1GHz	HKE-117	Dec. 09, 2021	1 Year
28.	RF Cable(above 1GHz)	Times	1-40G	HKE-034	Dec. 09, 2021	1 Year
29	RF Cable (9KHz-40GHz)	Tonscend	170660	N/A	Dec. 09, 2021	1 Year
30	Shielded room	Shiel Hong	4*3*3	HKE-039	Dec. 17, 2020	3 Year
31	Horn Antenna	Schewarzbeck	BBHA 9170	HKE-017	Dec. 09, 2021	1 Year

The results shown in this test report refer only to the sample(s) tested unless otherwise stated and the sample(s) are retained for 30 days only. The document is issued by HUAK, this document cannot be reproduced except in full with our prior written permission. The more details and the authenticity of the report will be confirmed at <http://www.cer-mark.com>.

HUAK Testing Lab TEL : +86-755 2302 9901 FAX : +86-755 2302 9901 E-mail : service@cer-mark.com

1-2/F., Building B2, Junfeng Zhongcheng Zhizao Innovation Park, Heping, Fuhai Street, Bao'an District, Shenzhen, Guangdong, China

4 Test Result

4.1 Antenna Requirement

4.1.1 Standard requirement

Standard Applicable

For intentional device, according to FCC 47 CFR Section 15.203, an intentional radiator shall be designed to ensure that no antenna other than that furnished by the responsible party shall be used with the device. And according to FCC 47 CFR Section 15.247, if transmitting antennas of directional gain greater than 6dBi are used, the power shall be reduced by the amount in dB that the directional gain of the antenna exceeds 6dBi.

Refer to statement below for compliance.

The manufacturer may design the unit so that the user can replace a broken antenna, but the use of a standard antenna jack or electrical connector is prohibited. Further, this requirement does not apply to intentional radiators that must be professionally installed.

Antenna Connected Construction

The antenna used in this product is a PCB antenna which permanently attached. It conforms to the standard requirements. The directional gains of antenna used for transmitting is 2.34dBi.

4.1.2 EUT Antenna

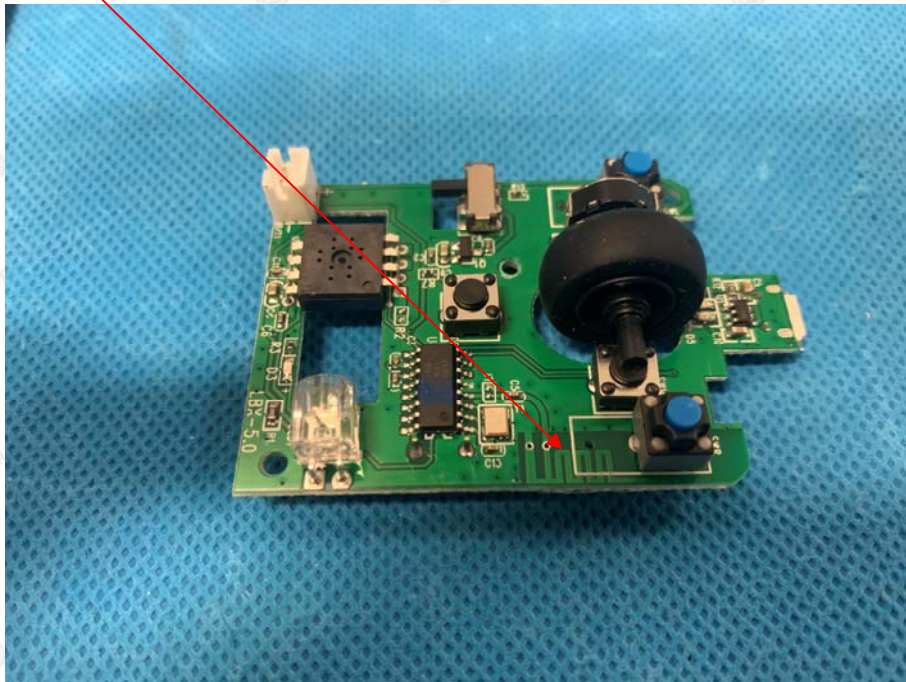



4.2 Conduction Emissions Measurement

4.2.1 Applied procedures / Limit

According to FCC CFR Title 47 Part 15 Subpart C Section 15.207, AC Power Line Conducted Emissions Limits for Licence-Exempt Radio Apparatus as below:

Frequency range (MHz)	Limit (dBuV)	
	Quasi-peak	Average
0.15-0.5	66 to 56*	56 to 46*
0.5-5	56	46
5-30	60	50

* Decreases with the logarithm of the frequency.

4.2.2 Test procedure

1. The equipment was set up as per the test configuration to simulate typical actual usage per the user's manual. The EUT is placed on turntable; a wooden table with a height of 0.8 meters is used and is placed on the ground plane as per ANSI C63.10:2013.
2. Support equipment, if needed, was placed as per ANSI C63.10:2013
3. All I/O cables were positioned to simulate typical actual usage as per ANSI C63.10:2013.
4. The adapter received AC120V/60Hz power through a Line Impedance Stabilization Network (LISN) which supplied power source and was grounded to the ground plane.
5. All support equipments received AC power from a second LISN, if any.
6. The EUT test program was started. Emissions were measured on each current carrying line of the EUT using a spectrum Analyzer / Receiver connected to the LISN powering the EUT. The LISN has two monitoring points: Line 1 (Hot Side) and Line 2 (Neutral Side). Two scans were taken: one with Line 1 connected to Analyzer / Receiver and Line 2 connected to a 50 ohm load; the second scan had Line 1 connected to a 50 ohm load and Line 2 connected to the Analyzer / Receiver.
7. Analyzer / Receiver scanned from 150 KHz to 30MHz for emissions in each of the test modes.
8. During the above scans, the emissions were maximized by cable manipulation.

4.2.3 Test setup

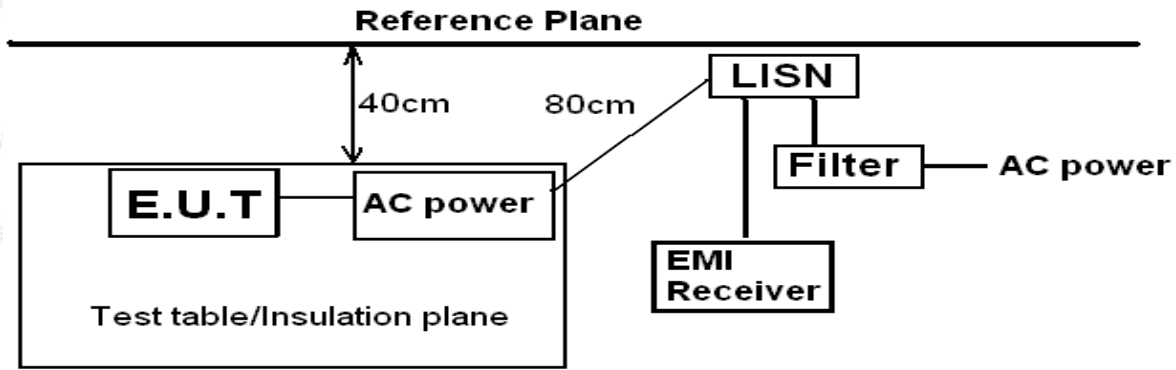

Remark:

E.U.T: Equipment Under Test

LISN: Line Impedance Stabilization Network

Test table height=0.8m



4.2.4 Test results

Test Specification: Line

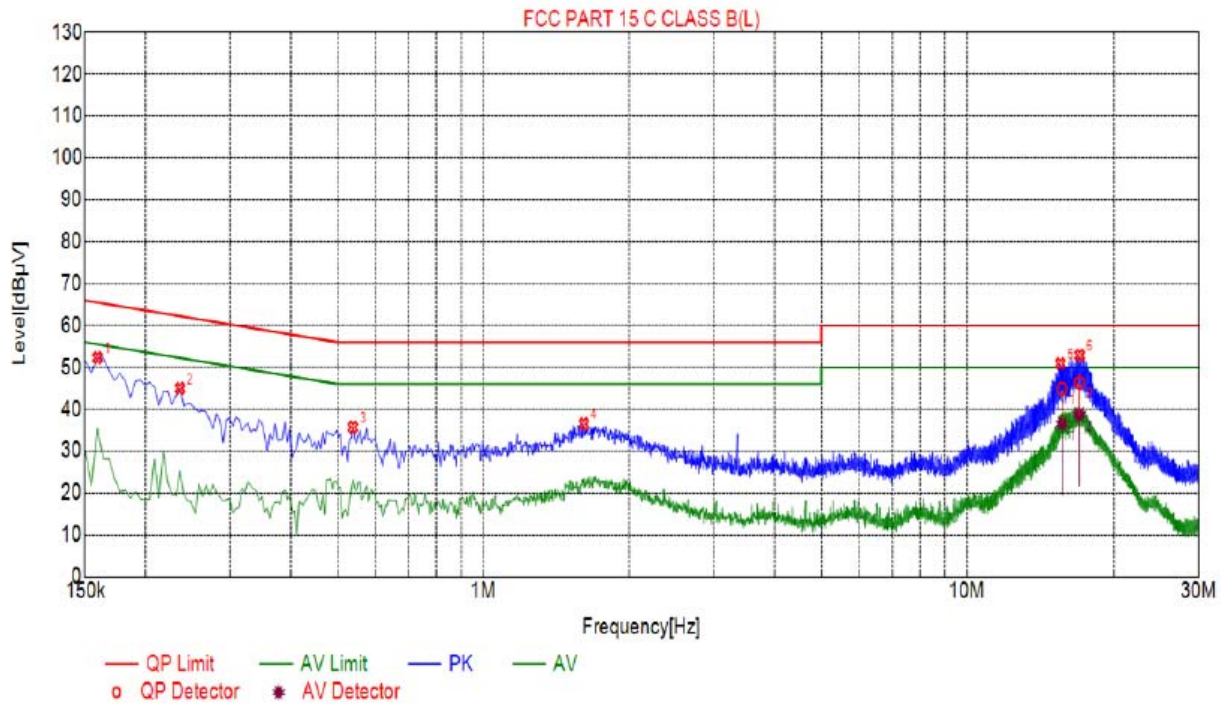

Suspected List

NO.	Freq. [MHz]	Level [dBµV]	Factor [dB]	Limit [dBµV]	Margin [dB]	Reading [dBµV]	Detector	Type
1	0.1590	52.31	20.01	65.52	13.21	32.30	PK	L
2	0.2355	44.98	20.03	62.25	17.27	24.95	PK	L
3	0.5370	35.69	20.05	56.00	20.31	15.64	PK	L
4	1.6125	36.49	20.11	56.00	19.51	16.38	PK	L
5	15.5130	50.91	19.97	60.00	9.09	30.94	PK	L
6	17.0025	52.91	20.00	60.00	7.09	32.91	PK	L

Final Data List

NO.	Freq. [MHz]	Correction factor [dB]	QP Value [dBµV]	QP Limit [dBµV]	QP Margin [dB]	QP Reading [dBµV]	AV Value [dBµV]	AV Limit [dBµV]	AV Margin [dB]	AV Reading [dBµV]	Type
1	15.6473	19.97	44.91	60.00	15.09	24.94	36.49	50.00	13.51	16.52	L
2	16.9735	20.00	46.38	60.00	13.62	26.38	38.73	50.00	11.27	18.73	L

Remark: Margin = Limit – Level

Correction factor = Cable lose + LISN insertion loss

Level=Test receiver reading + correction factor

The results shown in this test report refer only to the sample(s) tested unless otherwise stated and the sample(s) are retained for 30 days only. The document is issued by HUAKE, this document cannot be reproduced except in full with our prior written permission. The more details and the authenticity of the report will be confirmed at <http://www.cer-mark.com>.

HUAKE Testing Lab TEL : +86-755 2302 9901 FAX : +86-755 2302 9901 E-mail : service@cer-mark.com

1-2/F., Building B2, Junfeng Zhongcheng Zhizao Innovation Park, Heping, Fuhai Street, Bao'an District, Shenzhen, Guangdong, China



Test Specification: Neutral

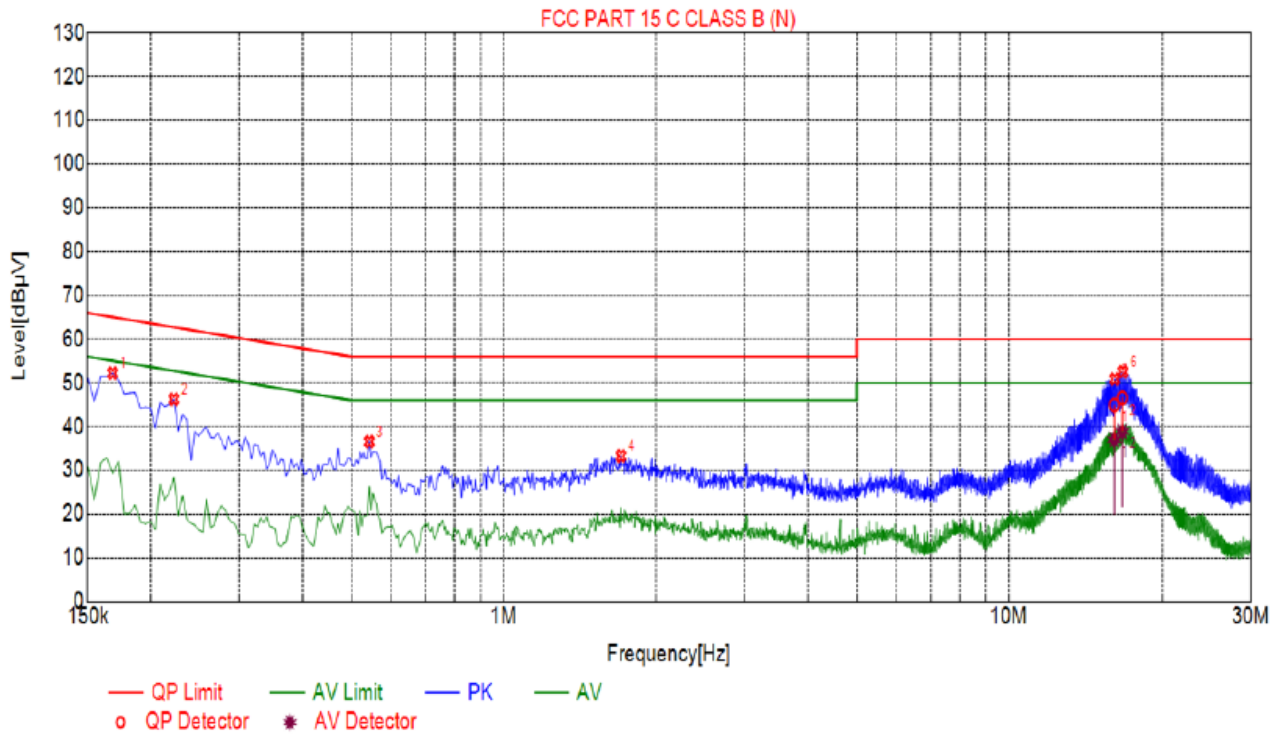

Suspected List

NO.	Freq. [MHz]	Level [dBµV]	Factor [dB]	Limit [dBµV]	Margin [dB]	Reading [dBµV]	Detector	Type
1	0.1680	52.22	20.01	65.06	12.84	32.21	PK	N
2	0.2220	46.24	20.04	62.74	16.50	26.20	PK	N
3	0.5415	36.54	20.05	56.00	19.46	16.49	PK	N
4	1.7070	33.27	20.13	56.00	22.73	13.14	PK	N
5	16.1115	50.86	19.98	60.00	9.14	30.88	PK	N
6	16.7280	52.53	19.99	60.00	7.47	32.54	PK	N

Final Data List

NO.	Freq. [MHz]	Correction factor [dB]	QP Value [dBµV]	QP Limit [dBµV]	QP Margin [dB]	QP Reading [dBµV]	AV Value [dBµV]	AV Limit [dBµV]	AV Margin [dB]	AV Reading [dBµV]	Type
1	16.0772	19.98	44.94	60.00	15.06	24.96	37.01	50.00	12.99	17.03	N
2	16.6781	19.99	46.56	60.00	13.44	26.57	38.86	50.00	11.14	18.87	N

Remark: Margin = Limit – Level
 Correction factor = Cable lose + LISN insertion loss
 Level=Test receiver reading + correction factor

The results shown in this test report refer only to the sample(s) tested unless otherwise stated and the sample(s) are retained for 30 days only. The document is issued by HUAKE, this document cannot be reproduced except in full with our prior written permission. The more details and the authenticity of the report will be confirmed at <http://www.cer-mark.com>.

4.3 Radiated Emissions Measurement

4.3.1 Applied procedures / Limit

For intentional device, according to § 15.209(a), the general requirement of field strength of radiated emission out of authorized band shall not exceed the following table at a 3 meters measurement distance.

In addition, radiated emissions which fall in the restricted bands, as defined in §15.205(a), must also comply with the radiated emission limits specified in §15.209(a)

Except when the requirements applicable to a given device state otherwise, emissions from licence exempt transmitters shall comply with the field strength limits shown in table below. Additionally, the level of any transmitter emission shall not exceed the level of the transmitter’s fundamental emission.

Radiated emission limits

Frequency (MHz)	Distance (Meters)	Radiated (dBµV/m)	Radiated (µV/m)
0.009-0.49	3	$20\log(2400/F(KHz))+40\log(300/3)$	$2400/F(KHz)$
0.49-1.705	3	$20\log(24000/F(KHz))+ 40\log(30/3)$	$24000/F(KHz)$
1.705-30	3	$20\log(30)+ 40\log(30/3)$	30
30-88	3	40.0	100
88-216	3	43.5	150
216-960	3	46.0	200
Above 960	3	54.0	500

4.3.2 Test setup

Test Configuration:

- 1) 9 kHz to 30 MHz emissions:

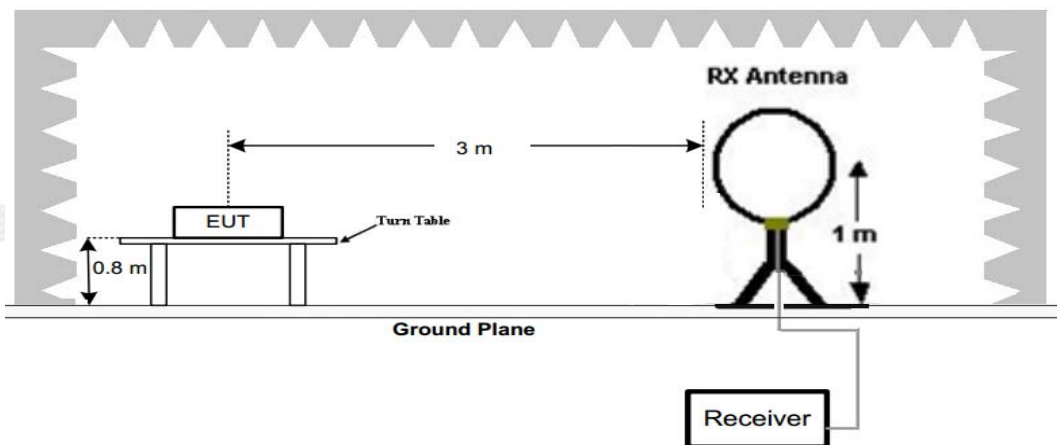

The results shown in this test report refer only to the sample(s) tested unless otherwise stated and the sample(s) are retained for 30 days only. The document is issued by HUAK, this document cannot be reproduced except in full with our prior written permission. The more details and the authenticity of the report will be confirmed at <http://www.cer-mark.com>.



2) 30 MHz to 1 GHz emissions:

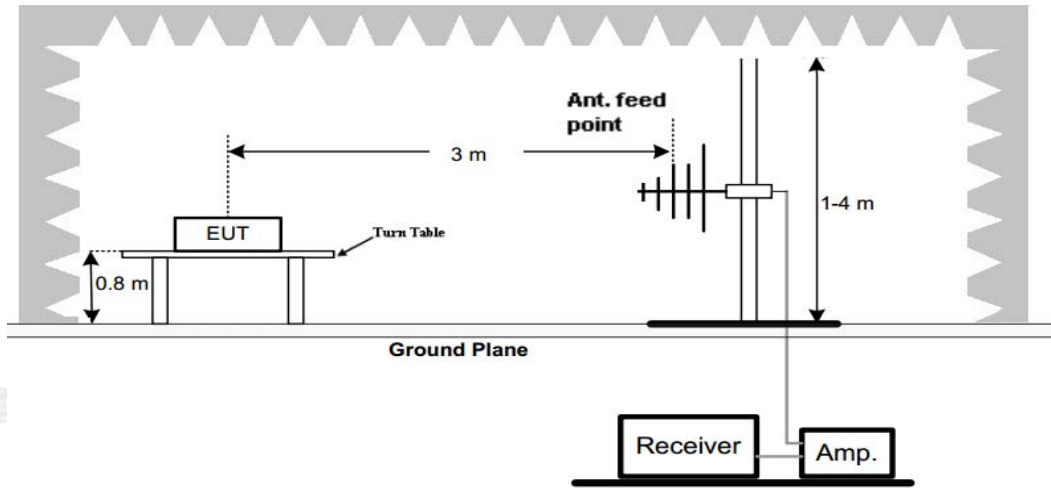

3)

1 GHz to 25 GHz emissions:

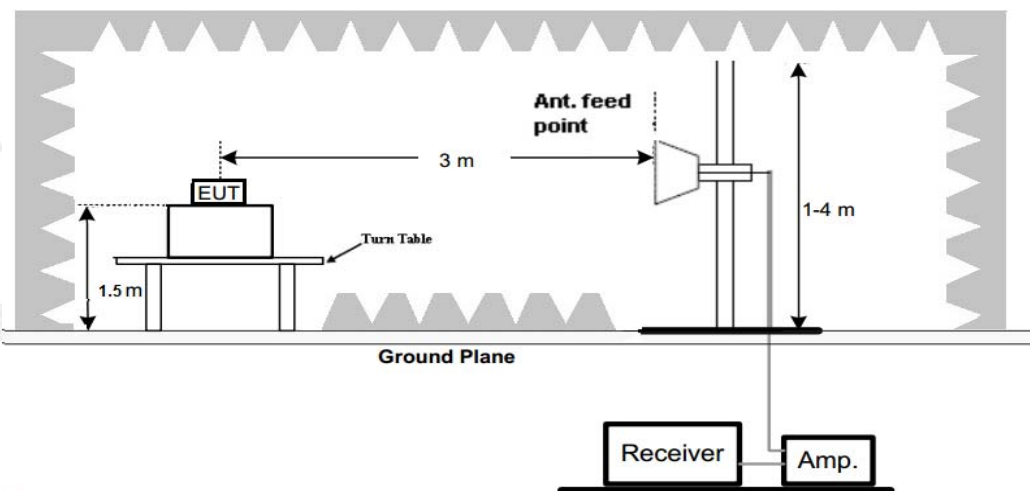

Test Procedure

1. The EUT was placed on turn table which is 0.8m above ground plane for below 1GHz test, and on a low permittivity and low loss tangent turn table which is 1.5m above ground plane for above 1GHz test.
2. Maximum procedure was performed by raising the receiving antenna from 1m to 4m and rotating the turn table from 0°C to 360°C to acquire the highest emissions from EUT
3. And also, each emission was to be maximized by changing the polarization of receiving antenna both horizontal and vertical.
4. Repeat above procedures until all frequency measurements have been completed.

The results shown in this test report refer only to the sample(s) tested unless otherwise stated and the sample(s) are retained for 30 days only. The document is issued by HUAK, this document cannot be reproduced except in full with our prior written permission. The more details and the authenticity of the report will be confirmed at <http://www.cer-mark.com>.



4.3.3 Test Result

Below 1GHz Test Results:

Antenna polarity: H

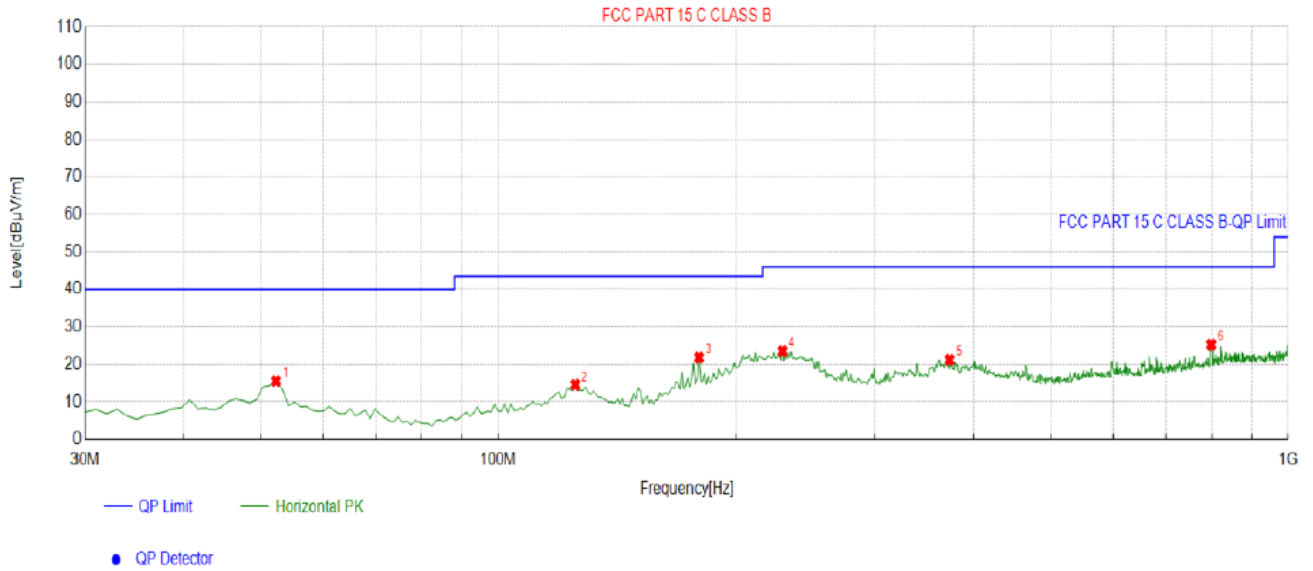

Suspected List									
NO.	Freq. [MHz]	Factor [dB]	Reading [dBµV/m]	Level [dBµV/m]	Limit [dBµV/m]	Margin [dB]	Height [cm]	Angle [°]	Polarity
1	52.3323	-14.00	29.54	15.54	40.00	24.46	100	327	Horizontal
2	125.1552	-17.86	32.41	14.55	43.50	28.95	100	105	Horizontal
3	179.5295	-16.88	38.70	21.82	43.50	21.68	100	272	Horizontal
4	229.0490	-14.34	37.86	23.52	46.00	22.48	100	74	Horizontal
5	372.7528	-10.95	32.19	21.24	46.00	24.76	100	34	Horizontal
6	799.0090	-3.13	28.39	25.26	46.00	20.74	100	188	Horizontal

Remark: Factor = Cable loss + Antenna factor – Preamplifier; Level = Reading + Factor; Margin = Limit – Level

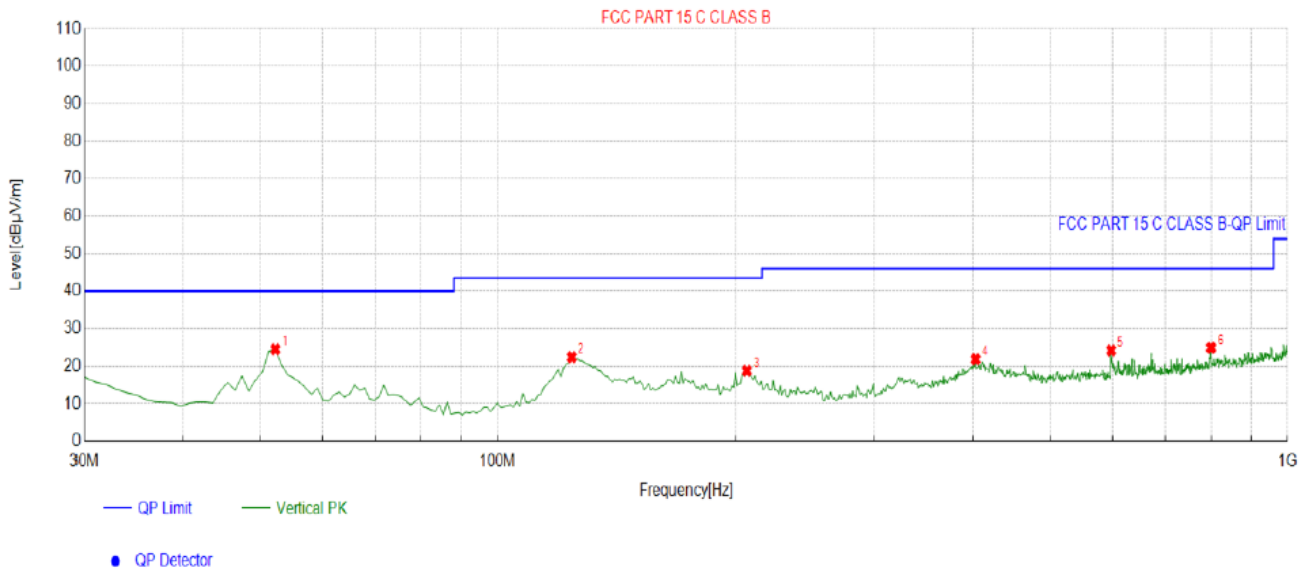

Suspected List									
NO.	Freq. [MHz]	Factor [dB]	Reading [dBµV/m]	Level [dBµV/m]	Limit [dBµV/m]	Margin [dB]	Height [cm]	Angle [°]	Polarity
1	52.3323	-14.00	38.50	24.50	40.00	15.50	100	36	Vertical
2	124.1842	-17.72	40.16	22.44	43.50	21.06	100	155	Vertical
3	206.7167	-14.89	33.68	18.79	43.50	24.71	100	136	Vertical
4	402.8529	-10.35	32.22	21.87	46.00	24.13	100	60	Vertical
5	598.0180	-6.24	30.46	24.22	46.00	21.78	100	9	Vertical
6	799.9800	-3.12	28.04	24.92	46.00	21.08	100	151	Vertical

Remark: Factor = Cable loss + Antenna factor – Preamplifier; Level = Reading + Factor; Margin = Limit – Level

Remark:

- (1) Measuring frequencies from 9 KHz to the 1 GHz, Radiated emission test from 9KHz to 30MHz was verified, and no any emission was found except system noise floor.
- (2) * denotes emission frequency which appearing within the Restricted Bands specified in provision of 15.205, then the general radiated emission limits in 15.209 apply.
- (3) The IF bandwidth of EMI Test Receiver between 30MHz to 1GHz was 120KHz, 1 MHz for measuring above 1 GHz, below 30MHz was 10KHz.



Harmonics and Spurious Emissions

Frequency Range (9 kHz-30MHz)

Frequency (MHz)	Level@3m (dBµV/m)	Limit@3m (dBµV/m)
--	--	--
--	--	--
--	--	--
--	--	--

Note:1. Emission Level=Reading+ Cable loss+ Antenna factor-Amp factor

2. The emission levels are 20 dB below the limit value, which are not reported. It is deemed to comply with the requirement



For 1GHz to 25GHz

CH Low (2402MHz)

Horizontal:

Frequency (MHz)	Meter Reading (dBμV)	Factor (dB)	Emission Level (dBμV/m)	Limits (dBμV/m)	Margin (dB)	Detector Type
4804	57.61	-3.65	53.96	74.00	-20.04	peak
4804	46.01	-3.65	42.36	54.00	-11.64	AVG
7206	56.98	-0.95	56.03	74.00	-17.97	peak
7206	42.15	-0.95	41.20	54.00	-12.80	AVG

Remark: Factor = Antenna Factor + Cable Loss – Pre-amplifier.

Vertical:

Frequency (MHz)	Meter Reading (dBμV)	Factor (dB)	Emission Level (dBμV/m)	Limits (dBμV/m)	Margin (dB)	Detector Type
4804	58.97	-3.65	55.32	74.00	-18.68	peak
4804	45.16	-3.65	41.51	54.00	-12.49	AVG
7206	55.38	-0.95	54.43	74.00	-19.57	peak
7206	42.22	-0.95	41.27	54.00	-12.73	AVG

Remark: Factor = Antenna Factor + Cable Loss – Pre-amplifier.



CH Middle (2440MHz)

Horizontal:

Frequency (MHz)	Meter Reading (dBμV)	Factor (dB)	Emission Level (dBμV/m)	Limits (dBμV/m)	Margin (dB)	Detector Type
4880.00	59.01	-3.54	55.47	74.00	-18.53	peak
4880.00	43.26	-3.54	39.72	54.00	-14.28	AVG
7320.00	56.82	-0.81	56.01	74.00	-17.99	peak
7320.00	42.16	-0.81	41.35	54.00	-12.65	AVG

Remark: Factor = Antenna Factor + Cable Loss – Pre-amplifier.

Vertical:

Frequency (MHz)	Meter Reading (dBμV)	Factor (dB)	Emission Level (dBμV/m)	Limits (dBμV/m)	Margin (dB)	Detector Type
4880.00	59.37	-3.54	55.83	74.00	-18.17	peak
4880.00	45.19	-3.54	41.65	54.00	-12.35	AVG
7320.00	56.32	-0.81	55.51	74.00	-18.49	peak
7320.00	43.39	-0.81	42.58	54.00	-11.42	AVG

Remark: Factor = Antenna Factor + Cable Loss – Pre-amplifier.



CH High (2480MHz)

Horizontal:

Frequency (MHz)	Meter Reading (dBμV)	Factor (dB)	Emission Level (dBμV/m)	Limits (dBμV/m)	Margin (dB)	Detector Type
4960	58.79	-3.43	55.36	74.00	-18.64	peak
4960	45.61	-3.44	42.17	54.00	-11.83	AVG
7440	56.28	-0.77	55.51	74.00	-18.49	peak
7440	42.35	-0.77	41.58	54.00	-12.42	AVG

Remark: Factor = Antenna Factor + Cable Loss – Pre-amplifier.

Vertical:

Frequency (MHz)	Meter Reading (dBμV)	Factor (dB)	Emission Level (dBμV/m)	Limits (dBμV/m)	Margin (dB)	Detector Type
4960	58.64	-3.43	55.21	74.00	-18.79	peak
4960	45.18	-3.44	41.74	54.00	-12.26	AVG
7440	56.28	-0.77	55.51	74.00	-18.49	peak
7440	44.01	-0.77	43.24	54.00	-10.76	AVG

Remark: Factor = Antenna Factor + Cable Loss – Pre-amplifier.

Remark:

- (1) Measuring frequencies from 1 GHz to the 25 GHz.
- (2) "F" denotes fundamental frequency; "H" denotes spurious frequency. "E" denotes band edge frequency.
- (3) * denotes emission frequency which appearing within the Restricted Bands specified in provision of 15.205, then the general radiated emission limits in 15.209 apply.
- (4) The emissions are attenuated more than 20dB below the permissible limits are not recorded in the report.
- (5) The IF bandwidth of EMI Test Receiver between 30MHz to 1GHz was 120KHz, 1 MHz for measuring above 1 GHz, below 30MHz was 10KHz. The resolution bandwidth of test receiver/spectrum analyzer is 1MHz and video bandwidth is 3MHz for peak measurement with peak detector at frequency above 1GHz. The resolution bandwidth of test receiver/spectrum analyzer is 1MHz and video bandwidth is 10Hz for Average measurement with peak detection at frequency above 1GHz.
- (6) When the test results of Peak Detected below the limits of Average Detected, the Average Detected is not need completed. For example: Top Channel at Fundamental 73.16dBuV/m(PK Value) <93.98(AV Limit), at harmonic 53.20 dBuV/m(PK Value) <54 dBuV/m(AV Limit), the Average Detected not need to completed.
- (7) All modes of operation were investigated and the worst-case emissions are reported.



Radiated Band Edge Test:

Operation Mode: TX CH Low (2402MHz)

Horizontal (Worst case):

Frequency (MHz)	Reading Result (dBμV)	Factor (dB)	Emission Level (dBμV/m)	Limits (dBμV/m)	Margin (dB)	Detector Type
2310.00	56.38	-5.81	50.57	74	-23.43	peak
2310.00	/	-5.81	/	54	/	AVG
2390.00	57.47	-5.84	51.63	74	-22.37	peak
2390.00	/	-5.84	/	54	/	AVG
2400.00	58.01	-5.84	52.17	74	-21.83	peak
2400.00	/	-5.84	/	54	/	AVG

Remark: Factor = Antenna Factor + Cable Loss – Pre-amplifier.

Vertical:

Frequency (MHz)	Reading Result (dBμV)	Factor (dB)	Emission Level (dBμV/m)	Limits (dBμV/m)	Margin (dB)	Detector Type
2310.00	57.61	-5.81	51.8	74	-22.2	peak
2310.00	/	-5.81	/	54	/	AVG
2390.00	58.66	-5.84	52.82	74	-21.18	peak
2390.00	/	-5.84	/	54	/	AVG
2400.00	57.34	-5.84	51.5	74	-22.5	peak
2400.00	/	-5.84	/	54	/	AVG

Remark: Factor = Antenna Factor + Cable Loss – Pre-amplifier.



Operation Mode: TX CH High (2480MHz)

Horizontal (Worst case)

Frequency (MHz)	Meter Reading (dBµV)	Factor (dB)	Emission Level (dBµV/m)	Limits (dBµV/m)	Margin (dB)	Detector Type
2483.50	56.32	-5.81	50.51	74	-23.49	peak
2483.50	/	-5.81	/	54	/	AVG
2500.00	55.14	-6.06	49.08	74	-24.92	peak
2500.00	/	-6.06	/	54	/	AVG
Remark: Factor = Antenna Factor + Cable Loss – Pre-amplifier.						

Vertical:

Frequency (MHz)	Meter Reading (dBµV)	Factor (dB)	Emission Level (dBµV/m)	Limits (dBµV/m)	Margin (dB)	Detector Type
2483.50	57.14	-5.81	51.33	74	-22.67	peak
2483.50	/	-5.81	/	54	/	AVG
2500.00	56.29	-6.06	50.23	74	-23.77	peak
2500.00	/	-6.06	/	54	/	AVG
Remark: Factor = Antenna Factor + Cable Loss – Pre-amplifier.						
Remark: All the other emissions not reported were too low to read and deemed to comply with FCC limit.						

4.4 Maximum Output Power Measurement

4.4.1 Limit

The Maximum Peak Output Power Measurement is 30dBm.

4.4.2 Test procedure

The maximum peak conducted output power may be measured using a broadband peak RF power meter. The power meter shall have a video bandwidth that is greater than or equal to the DTS bandwidth and shall utilize a fast-responding diode detector.

The maximum Average conducted output power may be measured using a wideband RF power meter with a thermocouple director or equivalent. The power meter shall have a video bandwidth that is greater than or equal to the DTS bandwidth and shall utilize a fast-responding diode detector.

4.4.3 Deviation from standard

No deviation.

4.4.4 Test setup

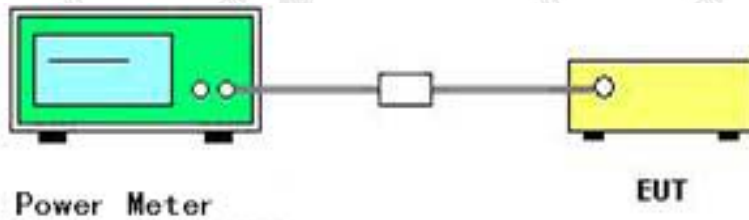

4.4.5 Test results

Channel	Channel frequency (MHz)	Output power (dBm)	Limit (dBm)	Result
Low	2402	3.13	30	Pass
Middle	2440	3.24		Pass
High	2480	2.68		Pass



4.5 Power Spectral Density

4.5.1 Limit

For digitally modulated systems, the power spectral density conducted from the intentional radiator to the antenna shall not be greater than 8 dBm in any 3 kHz band during any time interval of continuous transmission.

4.5.2 Test procedure

Use this procedure when the maximum peak conducted output power in the fundamental emission is used to demonstrate compliance.

Set the RBW =3 kHz.

Set the VBW =10 KHz.

Set the span to 1.5 times the DTS channel bandwidth.

Detector = peak.

Sweep time = auto couple.

Trace mode = max hold.

Allow trace to fully stabilize.

Use the peak marker function to determine the maximum power level.

If measured value exceeds limit, reduce RBW(no less than 3 kHz)and repeat.

The resulting peak PSD level must be 8 dBm.

4.5.3 Deviation from standard

No deviation.

4.5.4 Test setup





4.5.5 Test results

Channel	Channel frequency (MHz)	Power Spectral Density (dBm/3KHz)	Limit (dBm/3KHz)	Result
Low	2402	-12.62	8.00	Pass
Middle	2440	-12.75		Pass
High	2480	-13.54		Pass

CH 00

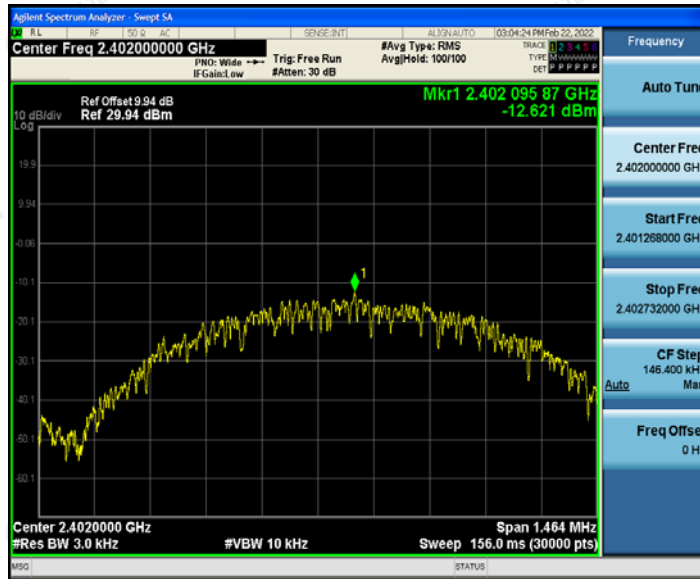

CH 19

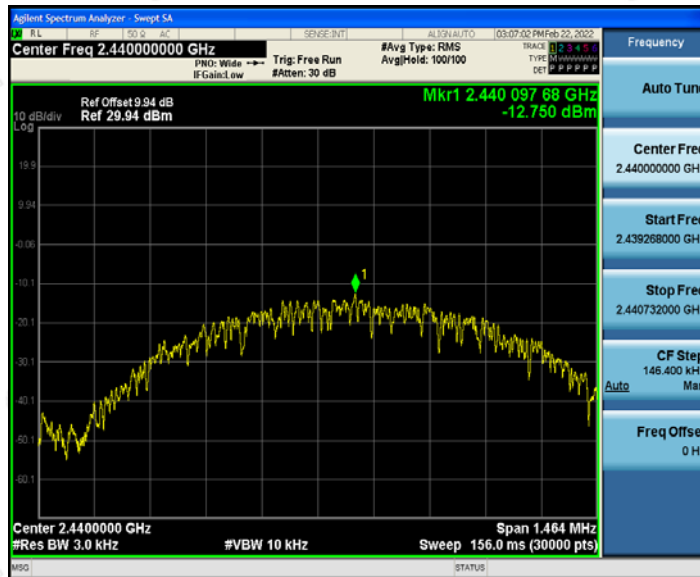

The results shown in this test report refer only to the sample(s) tested unless otherwise stated and the sample(s) are retained for 30 days only. The document is issued by HUAKE, this document cannot be reproduced except in full with our prior written permission. The more details and the authenticity of the report will be confirmed at <http://www.cer-mark.com>.



CH 39

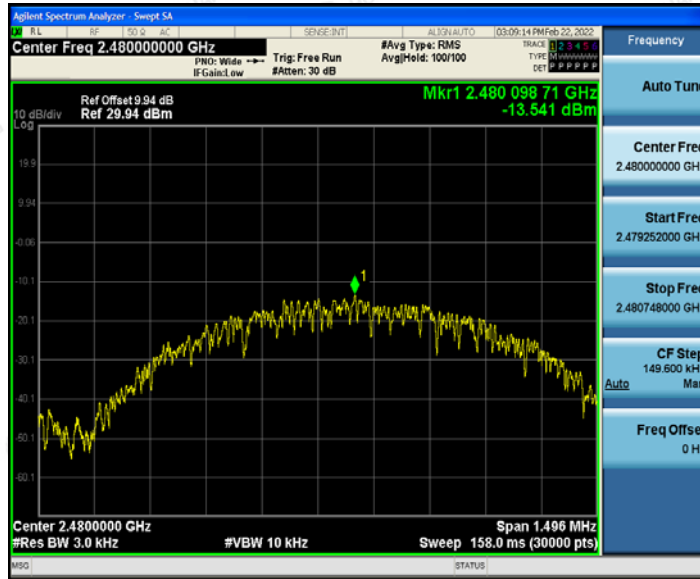

The results shown in this test report refer only to the sample(s) tested unless otherwise stated and the sample(s) are retained for 30 days only. The document is issued by HUAK, this document cannot be reproduced except in full with our prior written permission. The more details and the authenticity of the report will be confirmed at <http://www.cer-mark.com>.

HUAK Testing Lab TEL : +86-755 2302 9901 FAX : +86-755 2302 9901 E-mail : service@cer-mark.com

1-2/F., Building B2, Junfeng Zhongcheng Zhizao Innovation Park, Heping, Fuhai Street, Bao'an District, Shenzhen, Guangdong, China



4.6 6dB Bandwidth

4.6.1 Limit

For digital modulation systems, the minimum 6 dB bandwidth shall be at least 500 kHz.

4.6.2 Test procedure

The transmitter output was connected to the spectrum analyzer through an attenuator. The bandwidth of the fundamental frequency was measured by spectrum analyzer with RBW=100 KHz and VBW=300KHz. The 6dB bandwidth is defined as the total spectrum the power of which is higher than peak power minus 6dB.

1. Set RBW = 100 kHz.
2. Set the video bandwidth (VBW) ≥ 3 RBW.
3. Detector = Peak.
4. Trace mode = max hold.
5. Sweep = auto couple.
6. Allow the trace to stabilize.
7. Measure the maximum width of the emission that is constrained by the frequencies associated with the two outermost amplitude points (upper and lower frequencies) that are attenuated by 6 dB relative to the maximum level measured in the fundamental emission.

4.6.3 Deviation from standard

No deviation.

4.6.4 Test setup



4.6.5 Test result

Channel	Channel frequency (MHz)	6dB Bandwidth (MHz)	Limit (KHz)	Result
Low	2402	0.732	≥500	Pass
Middle	2440	0.732		Pass
High	2480	0.748		Pass

The results shown in this test report refer only to the sample(s) tested unless otherwise stated and the sample(s) are retained for 30 days only. The document is issued by HUAKE, this document cannot be reproduced except in full with our prior written permission. The more details and the authenticity of the report will be confirmed at <http://www.cer-mark.com>.



CH 00



CH 19



The results shown in this test report refer only to the sample(s) tested unless otherwise stated and the sample(s) are retained for 30 days only. The document is issued by HUAJ, this document cannot be reproduced except in full with our prior written permission. The more details and the authenticity of the report will be confirmed at <http://www.cer-mark.com>.



The results shown in this test report refer only to the sample(s) tested unless otherwise stated and the sample(s) are retained for 30 days only. The document is issued by HUAK, this document cannot be reproduced except in full with our prior written permission. The more details and the authenticity of the report will be confirmed at <http://www.cer-mark.com>.



4.7 Occupied Bandwidth

4.7.1 Test procedure

The occupied bandwidth is the frequency bandwidth such that, below its lower and above its upper frequency limits, the mean powers are each equal to 0.5% of the total mean power of the given emission. The following procedure shall be used for measuring 99% power bandwidth:

RBW=1% to 5% of the OBW

VBW=approximately 3 X RBW

Detector=Peak

Trace Mode: Max Hold

Use the 99% power bandwidth function of the instrument to measure the Occupied Bandwidth and recorded.

4.7.2 Deviation from standard

No deviation.

4.7.3 Test setup



4.7.4 Test result

N/A



4.8 Band edge

4.8.1 Limit

In any 100 kHz bandwidth outside the frequency band in which the spread spectrum or digitally modulated device is operating, the RF power that is produced shall be at least 20 dB below that in the 100 kHz bandwidth within the band that contains the highest level of the desired power, based on either an RF conducted or a radiated measurement, provided that the transmitter demonstrates compliance with the peak conducted power limits. If the transmitter complies with the conducted power limits based on the use of root-mean-square averaging over a time interval, as permitted under FCC rules in section 5.8.1, the attenuation required shall be 30 dB instead of 20 dB.

4.8.2 Test procedure

- a. The EUT was directly connected to the spectrum analyzer and antenna output port as show in the block diagram below.
- b. Span = wide enough to capture the peak level of the emission operating on the channel closest to the bandedge, as well as any modulation products which fall outside of the authorized band of operation, RBW \geq 1% of the span, VBW \geq RBW, Sweep = auto, Detector function = peak, Trace = max hold

4.8.3 Deviation from standard

No deviation.

4.8.4 Test setup

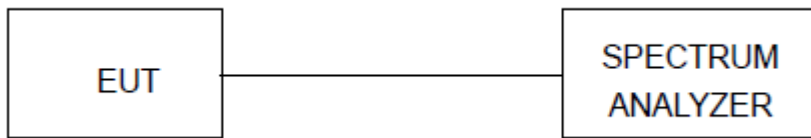



4.8.5 Test results

PASS

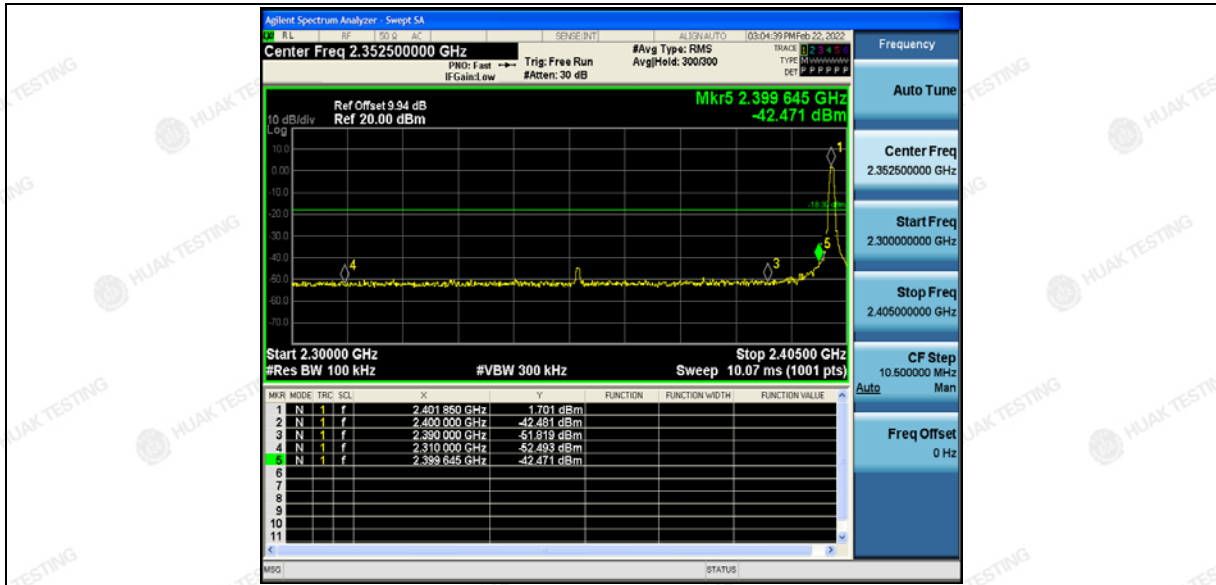

2402

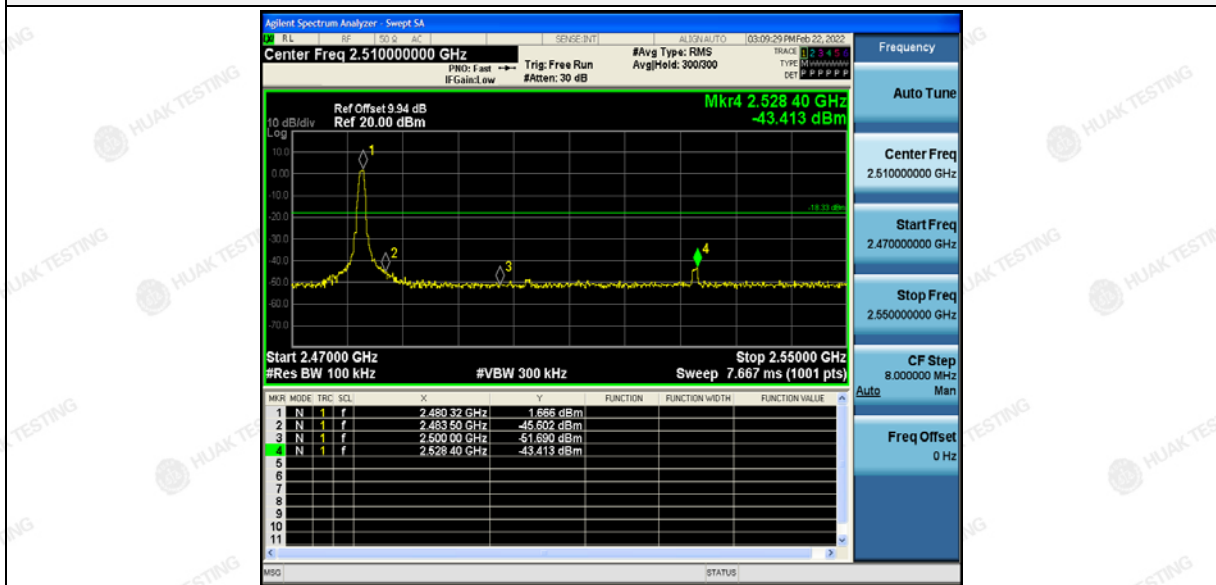

2480

The results shown in this test report refer only to the sample(s) tested unless otherwise stated and the sample(s) are retained for 30 days only. The document is issued by HUAJ, this document cannot be reproduced except in full with our prior written permission. The more details and the authenticity of the report will be confirmed at <http://www.cer-mark.com>.



4.9 Conducted Spurious Emissions

4.9.1 Applied procedures / Limit

In any 100 kHz bandwidth outside the frequency band in which the spread spectrum or digitally modulated device is operating, the RF power that is produced shall be at least 20 dB below that in the 100 kHz bandwidth within the band that contains the highest level of the desired power, based on either an RF conducted or a radiated measurement, provided that the transmitter demonstrates compliance with the peak conducted power limits. If the transmitter complies with the conducted power limits based on the use of root-mean-square averaging over a time interval, as permitted under Section (b)(3) of RSS 5.4(4), the attenuation required shall be 30 dB instead of 20 dB. For below 30MHz, For 9KHz-150kHz, 150K-10MHz, We use the RBW 1KHz, 10KHz, So the limit need to calculated by “ $10\lg(BW1/BW2)$ ”. for example For 9KHz-150kHz, RBW 1KHz, The Limit= the highest emission level-20- $10\lg(100/1)$ = the highest emission level-40.

4.9.2 Test procedure

- a. The EUT was directly connected to the spectrum analyzer and antenna output port as show in the block diagram below.
- b. Span = wide enough to capture the peak level of the emission operating on the channel closest to the bandedge, as well as any modulation products which fall outside of the authorized band of operation, $RBW \geq 1\%$ of the span, $VBW \geq RBW$, Sweep = auto, Detector function = peak, Trace = max hold

4.9.3 Deviation from standard

No deviation.

4.9.4 Test setup





4.9.5 Test results

CH 00

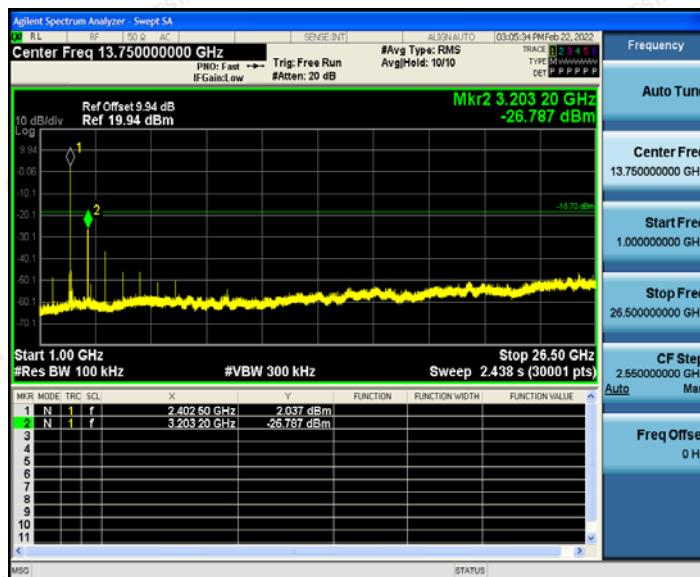
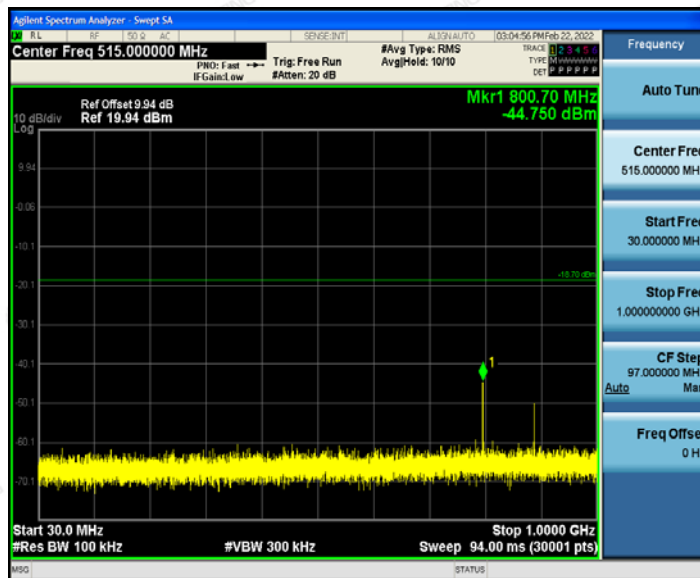

The results shown in this test report refer only to the sample(s) tested unless otherwise stated and the sample(s) are retained for 30 days only. The document is issued by HUAKE, this document cannot be reproduced except in full with our prior written permission. The more details and the authenticity of the report will be confirmed at <http://www.cer-mark.com>.



CH 19

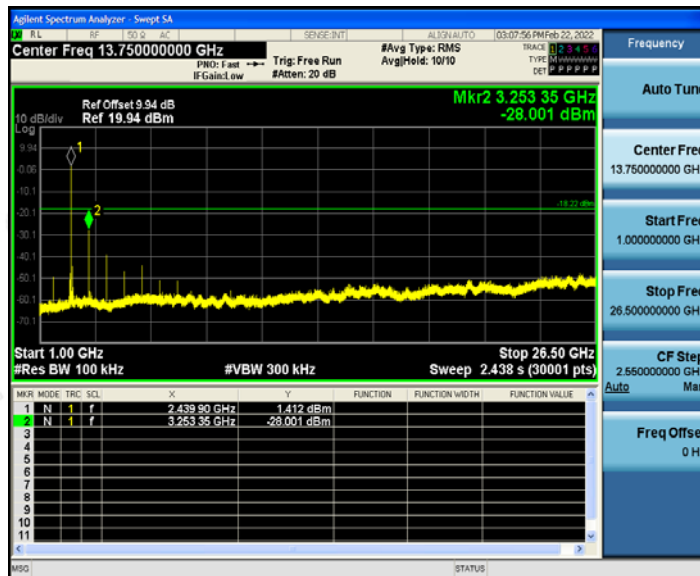
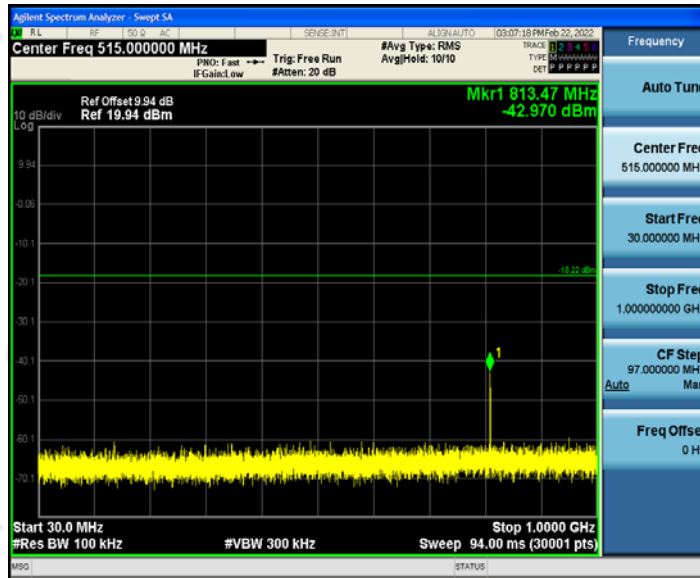

The results shown in this test report refer only to the sample(s) tested unless otherwise stated and the sample(s) are retained for 30 days only. The document is issued by HUAKE, this document cannot be reproduced except in full with our prior written permission. The more details and the authenticity of the report will be confirmed at <http://www.cer-mark.com>.



CH 39

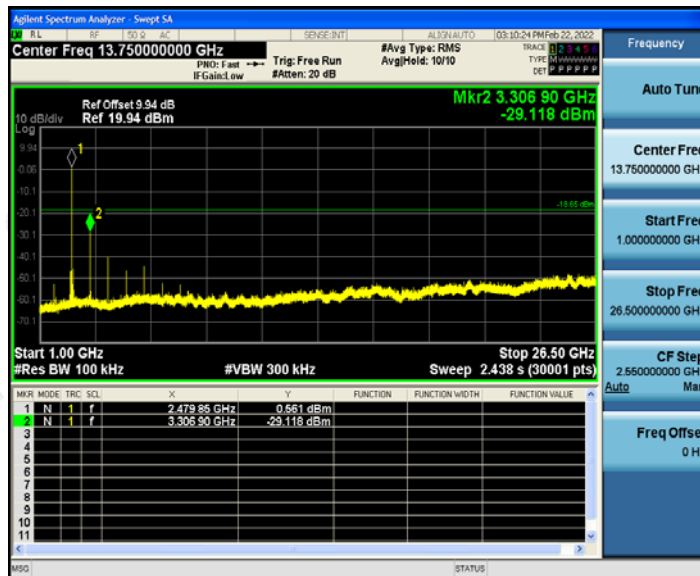
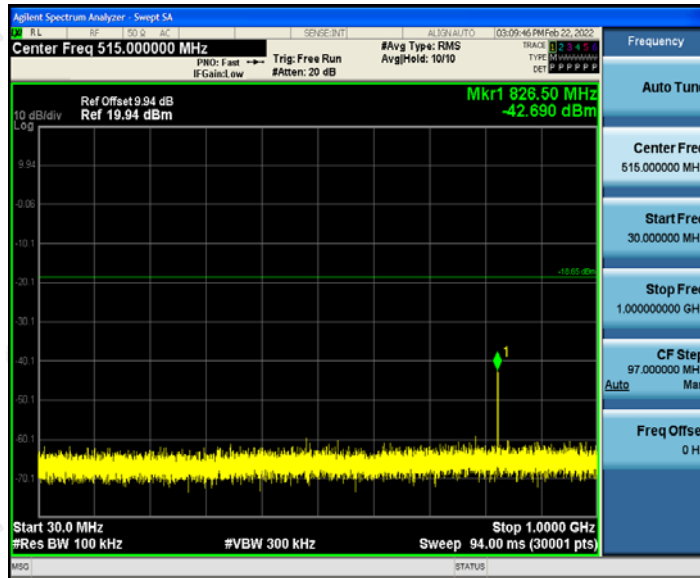

The results shown in this test report refer only to the sample(s) tested unless otherwise stated and the sample(s) are retained for 30 days only. The document is issued by HUAKE, this document cannot be reproduced except in full with our prior written permission. The more details and the authenticity of the report will be confirmed at <http://www.cer-mark.com>.



5 Test setup photo

Radiated Emissions

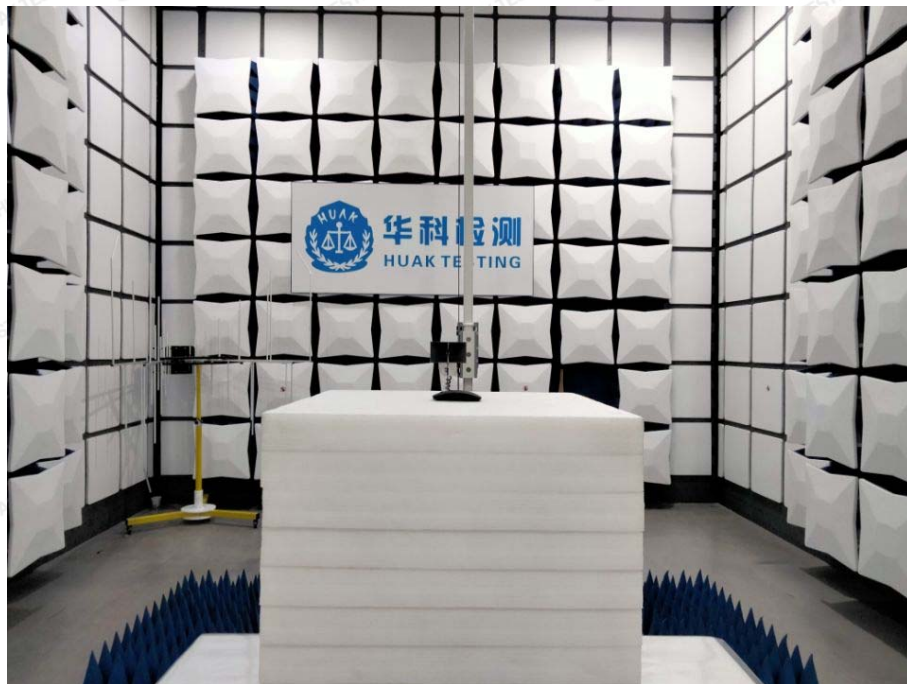
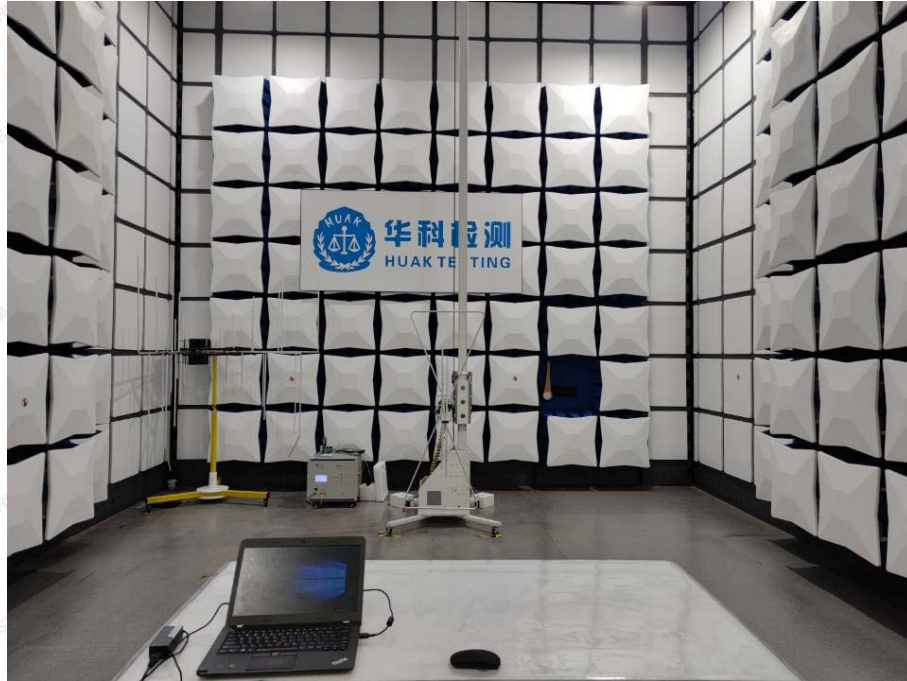

The results shown in this test report refer only to the sample(s) tested unless otherwise stated and the sample(s) are retained for 30 days only. The document is issued by HUAK, this document cannot be reproduced except in full with our prior written permission. The more details and the authenticity of the report will be confirmed at <http://www.cer-mark.com>.

HUAK Testing Lab TEL : +86-755 2302 9901 FAX : +86-755 2302 9901 E-mail : service@cer-mark.com

1-2/F., Building B2, Junfeng Zhongcheng Zhizao Innovation Park, Heping, Fuhai Street, Bao'an District, Shenzhen, Guangdong, China

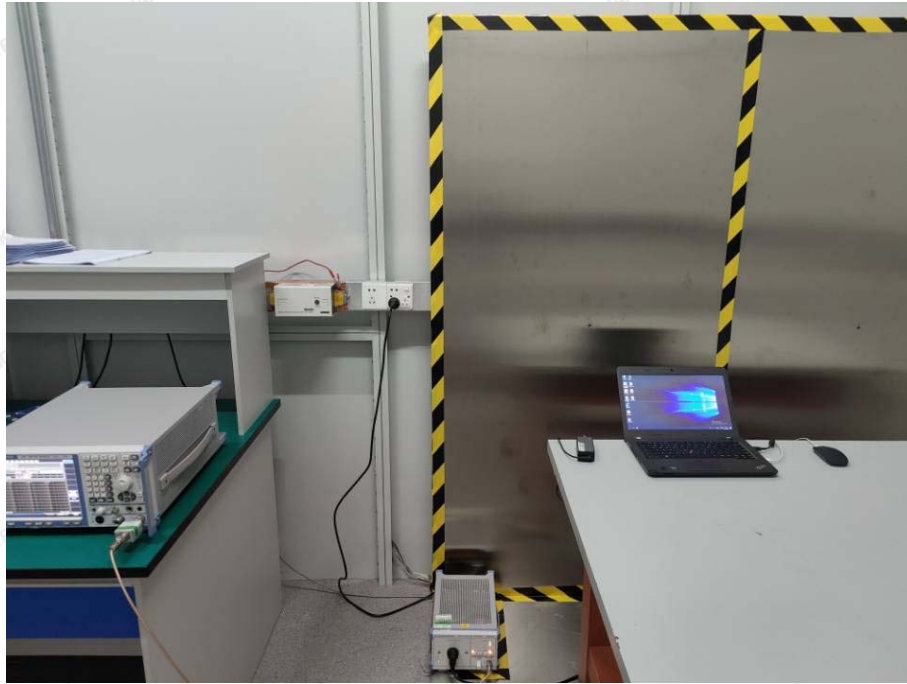

The results shown in this test report refer only to the sample(s) tested unless otherwise stated and the sample(s) are retained for 30 days only. The document is issued by HUAK, this document cannot be reproduced except in full with our prior written permission. The more details and the authenticity of the report will be confirmed at <http://www.cer-mark.com>.

HUAK Testing Lab TEL : +86-755 2302 9901 FAX : +86-755 2302 9901 E-mail : service@cer-mark.com

1-2/F., Building B2, Junfeng Zhongcheng Zhizao Innovation Park, Heping, Fuhai Street, Bao'an District, Shenzhen, Guangdong, China



6 PHOTOS OF THE EUT

Reference to the report: ANNEX A of external photos and ANNEX B of internal photos

-----End of test report-----