

Guangzhou Xaircraft Technology
CO.,LTD.

TEST REPORT

SCOPE OF WORK

FCC TESTING-13IFC-5A

REPORT NUMBER

250218071SZN-002

ISSUE DATE

12 June 2025 [-----]

[REVISED DATE]

PAGES

27

DOCUMENT CONTROL NUMBER

FCC ID 247_b

© 2017 INTERTEK



Guangzhou Xaircraft Technology CO.,LTD.Application
For
Certification**FCC ID: 2A46G-13IFC-5A****XAG FC5 Farm Camera****Model: 13IFC-5A****Brand Name: XAG****2.4GHz Wi-Fi Transceiver**

Report No.: 250218071SZN-002

We hereby certify that the sample of the above item is considered to comply with the requirements of FCC Part 15, Subpart C for Intentional Radiator, mention 47 CFR [10-1-23]

Prepared and Checked by:**Approved by:****Allen Qin**
Engineer

Johnny Wang
Project Engineer
Date: 12 June 2025

This report is for the exclusive use of Intertek's Client and is provided pursuant to the agreement between Intertek and its Client. Intertek's responsibility and liability are limited to the terms and conditions of the agreement. Intertek assumes no liability to any party, other than to the Client in accordance with the agreement, for any loss, expense or damage occasioned by the use of this report. Only the Client is authorized to permit copying or distribution of this report and then only in its entirety. Any use of the Intertek name or one of its marks for the sale or advertisement of the tested material, product or service must first be approved in writing by Intertek. The observations and test results in this report are relevant only to the sample tested. This report by itself does not imply that the material, product, or service is or has ever been under an Intertek certification program.

Intertek Testing Services Shenzhen Ltd. Longhua Branch

101, 201, Building B, No. 308 Wuhe Avenue, Zhangkengjing Community, GuanHu Subdistrict, LongHua District, Shenzhen, P.R. China.

Tel: (86 755) 8601 6288 Fax: (86 755) 8601 6751

MEASUREMENT/TECHNICAL REPORT

This report concerns (check one) Original Grant Class II Change

Equipment Type: DTS - Part 15 Digital Transmission Systems (Wi-Fi transmitter portion)

Deferred grant requested per 47 CFR 0.457(d)(1)(ii)? Yes No

If yes, defer until : _____
date

Company Name agrees to notify the Commission by: _____
date

of the intended date of announcement of the product so that the grant can be issued on that date.

Transition Rules Request per 15.37? Yes No

If no, assumed Part 15, Subpart C for intentional radiator - the new 47 CFR [10-01-23 Edition] provision.

Report prepared by:

Allen Qin
Intertek Testing Services Shenzhen Ltd. Longhua Branch
101, 201, Building B, No. 308 Wuhe Avenue, Zhangkengjing
Community, GuanHu Subdistrict, LongHua District, Shenzhen,
P.R. China.
Tel: (86 755) 8614 0743 Fax: (86 755) 8601 6661

Table of Contents

1.0	Summary of Test results	4
2.0	General Description	5
2.1	Product Description	5
2.2	Related Submittal(s) Grants	5
2.3	Test Methodology	5
2.4	Test Facility	5
3.0	System Test Configuration	5
3.1	Justification	5
3.2	EUT Exercising Software	6
3.3	Special Accessories	6
3.4	Measurement Uncertainty	7
3.5	Equipment Modification	7
3.6	Support Equipment List and Description	7
4.0	Measurement Results	8
4.1	Maximum Conducted Output Power at Antenna Terminals	8
4.2	Minimum 6 dB RF Bandwidth	9
4.3	Maximum Power Density Reading	10
4.4	Out of Band Conducted Emissions	11
4.5	Out of Band Radiated Emissions	12
4.6	Transmitter Radiated Emissions in Restricted Bands	13
4.7	Field Strength Calculation	14
4.8	Antenna information	15
4.9	Radiated Spurious Emission	15
4.10	Conducted Emission	22
4.11	Radiated Emissions from Digital Section of Transceiver	25
4.12	Transmitter Duty Cycle Calculation and Measurements	25
5.0	Equipment Photographs	26
6.0	Product Labelling	26
7.0	Technical Specifications	26
8.0	Instruction Manual	26
9.0	Confidentiality Request	26
10.0	Discussion of Pulse Desensitization	26
11.0	Test Equipment List	27

1.0 Summary of Test results

Applicant: Guangzhou Xaircraft Technology CO.,LTD.

Applicant Address: Block C, No.115, Gaopu Road, Tianhe District, Guangzhou Guangdong, P.R.China

Manufacturer: Guangzhou Xaircraft Technology CO.,LTD.

Manufacturer Address: Block C, No.115, Gaopu Road, Tianhe District, Guangzhou Guangdong, P.R.China

Model: 13IFC-5A

FCC ID: 2A46G-13IFC-5A

TEST ITEM	REFERENCE	RESULTS
Max. Output power	15.247(b)(3)	Pass
6 dB Bandwidth	15.247(a)(2)	Pass
Max. Power Density	15.247(e)	Pass
Out of Band Antenna Conducted Emission	15.247(d)	Pass
Radiated Emission in Restricted Bands	15.247(d), 15.209, FCC 15.205	Pass
AC Conducted Emission	15.207	Pass
Antenna Requirement	15.203	Pass (See Notes)

Notes:

1. The EUT uses an Integral Antenna which in accordance to Section 15.203 is considered sufficient to comply with the provisions of this section.

2.0 General Description

2.1 Product Description

The equipment under test (EUT) is a XAG FC5 Farm Camera with Bluetooth function operating in 2402-2480MHz, 2.4G WIFI function operating in 2412-2462MHz. The EUT is powered by DC5V from adapter or powered by a 21700 lithium battery. For more detail information pls. refer to the user manual.

2.4G WIFI:

Type of Modulation:

802.11b:CCK, DQPSK, DBPSK for DSSS.

802.11g: OFDM (BPSK, QPSK, 16QAM, 64QAM)

802.11n: OFDM (BPSK, QPSK, 16QAM, 64QAM)

Antenna Type: Fixed Internal Antenna

Antenna Gain: 2.97dBi, (This information is provided by manufacturer, and the manufacturer is responsible for the authenticity of the provided information.)

For electronic filing, the brief circuit description is saved with filename: descri.pdf.

2.2 Related Submittal(s) Grants

This is an application for certification of a transceiver for the XAG FC5 Farm Camera which has 2.4GHz WIFI function.

For the BLE function was tested and demonstrated in report 250218071SZN-001.

2.3 Test Methodology

Both AC mains line-conducted and radiated emission measurements were performed according to the procedures in ANSI C63.10 (2013) and KDB 558074 D01 v05r02. Radiated emission measurement was performed in semi-anechoic chamber and conducted emission measurement was performed in shield room. For radiated emission measurement, preliminary scans were performed in the semi-anechoic chamber only to determine the worst case modes. All radiated tests were performed at an antenna to EUT distance of 3 meters, unless stated otherwise in the "**Justification Section**" of this Application.

2.4 Test Facility

The Semi-anechoic chamber and shielded room used to collect the radiated data and conducted data are **Intertek Testing Services Shenzhen Ltd. Longhua Branch** and located at 101, 201, Building B, No. 308 Wuhe Avenue, Zhangkengjing Community, GuanHu Subdistrict, LongHua District, Shenzhen, P.R. China. This test facility and site measurement data have been fully placed on file with File Number: CN1188.

3.0 System Test Configuration

3.1 Justification

For emissions testing, the equipment under test (EUT) setup to transmit continuously to simplify the measurement methodology. Care was taken to ensure proper power supply voltages during

testing. During testing, all cables were manipulated to produce worst case emissions. The EUT was powered by DC 5V by adapter during the test.

The EUT supports 802.11b/g/n-HT20mode, there are one antenna is used, and all data rate were tested and only the worst case data is shown in the report.

For maximizing emissions, the EUT was rotated through 360°, the EUT was placed on the styrene turntable with 0.8m up to 1GHz and 1.5 m above 1GHz. The antenna height and polarization are varied during the search for maximum signal level. The antenna height is varied from 1 to 4 meters. Radiated emissions are taken at three meters unless the signal level is too low for measurement at that distance. If necessary, a pre-amplifier is used and/or the test is conducted at a closer distance.

All readings are extrapolated back to the equivalent three meter reading using inverse scaling with distance. Analyzer resolution is 100 kHz or greater for frequencies below 1000 MHz. The resolution is 1 MHz or greater for frequencies above 1000 MHz. The spurious emissions more than 20 dB below the permissible value are not reported.

The EUT and transmitting antenna was centered on the turntable.

Radiated emission measurement were performed the lowest radio frequency signal generated in the device which is greater than 9 kHz to the tenth harmonic of the highest fundamental frequency or to 40 GHz, whichever is lower.

3.2 EUT Exercising Software

The EUT exercise program (provided by client) used during radiated and conducted testing was designed to exercise the various system components in a manner similar to a typical use. The worst case configuration is used in all specified testing.

The parameters of test software setting:

During the test, Channel and power controlling software provided by the applicant was used to control the operating channel as well as the output power level. The RF output power selection is for the setting of RF output power expected by the application and is going to be fixed on the firmware of the end product.

Test software: ESPRFTestTool_v3.6

3.3 Special Accessories

N/A

3.4 Measurement Uncertainty

When determining of the test conclusion, the Measurement Uncertainty of test has been considered.

3.5 Equipment Modification

Any modifications installed previous to testing by Guangzhou Xaircraft Technology CO.,LTD. will be incorporated in each production model sold / leased in the United States.

No modifications were installed by Intertek Testing Services Shenzhen Ltd. Longhua Branch.

3.6 Support Equipment List and Description

Description	Manufacturer	Remark
Adapter (Provided by applicant)	Ikea	Model:E2501-NA Input: 100-240Vac 50/60Hz, 0.5A Output: 5Vdc 3A, 9Vdc 2.22A, 12Vdc 1.67A, 15Vdc 1.33A
USB Cable (Provided by applicant)	N/A	unshielded, 150cm

Applicant: Guangzhou Xaircraft Technology CO.,LTD.

Date of Test: 27 February 2025

Model: 13IFC-5A

4.0 Measurement Results

4.1 Maximum Conducted Output Power at Antenna Terminals, FCC Rules 15.247(b)(3):

The antenna power of the EUT was connected to the input of a broadband peak RF power meter. The power meter have a video bandwidth that is greater than DTS bandwidth and utilize a fast-responding diode detector. Power was read directly at the EUT antenna terminals with cable loss added.

Block Diagram:

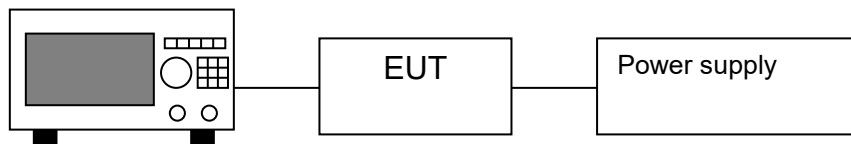

Power meter

For antennas with gains of 6 dBi or less, maximum allowed Transmitter output is 1 watt (+30 dBm). 2.4G band antenna gain:2.97dBi <6 dBi, so maximum allowed.

Transmitter output allowed 30dBm(1W) for conducted TX power.

Cable loss: 0.5 dB External Attenuation: 0 dB

Cable loss, external attenuation has been included in OFFSET function

Test Result: Please refer the Appendix of 250218071SZN-002 Appendix B.

For RF Exposure, the information is saved with filename: RF exposure.pdf.

Applicant: Guangzhou Xaircraft Technology CO.,LTD.

Date of Test: 27 February 2025

Model: 13IFC-5A

4.2 Minimum 6 dB RF Bandwidth, FCC Rule 15.247(a) (2):

The antenna port of the EUT was connected to the input of a spectrum analyzer. Analyzer RES BW was set to 100 KHz according to FCC KDB 558074 D01 v05r02. For each RF output channel investigated, the spectrum analyzer center frequency was set to the channel carrier. A PEAK output reading was taken, a DISPLAY line was drawn 6 dB lower than PEAK level. The 6dB bandwidth was determined from where the channel output spectrum intersected the display line.

Block Diagram:

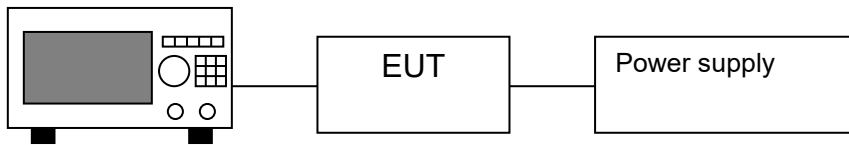

Spectrum Analyzer

Limit: The 6 dB Bandwidth is at least 500 kHz.

Test Result: Please refer the Appendix of 250218071SZN-002 Appendix A.

Applicant: Guangzhou Xaircraft Technology CO.,LTD.

Date of Test: 27 February 2025

Model: 13IFC-5A

4.3 Maximum Power Density Reading, FCC Rule 15.247(e):

The Measurement Procedure PKPSD was set according to the FCC KDB 558074 D01 v05r02.

Antenna output of the EUT was coupled directly to spectrum analyzer; if an external attenuator and/or cable was used, these losses are compensated for with the analyzer OFFSET function.

Block Diagram:

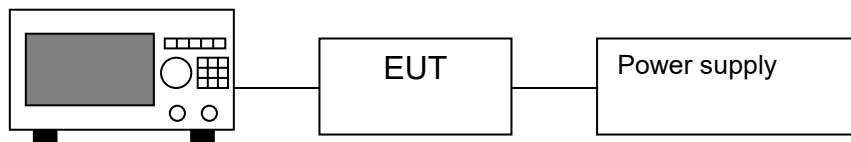

Spectrum Analyzer

Limit: The Power Density does not exceed 8dBm/3 kHz.

Test Result: Please refer the Appendix of 250218071SZN-002 Appendix C.

Applicant: Guangzhou Xaircraft Technology CO.,LTD.

Date of Test: 27 February 2025

Model: 13IFC-5A

4.4 Out of Band Conducted Emissions, FCC Rule 15.247(d)

In any 100 kHz bandwidth outside the frequency band in which the spread spectrum or digitally modulated intentional radiator is operating, the radio frequency power that is produced by the intentional radiator shall be at least 20 dB below that in the 100 kHz bandwidth within the band that contains the highest level of the desired power, based on either an RF conducted or a radiated measurement. The Measurement Procedure was set according to the FCC KDB 558074 D01 v05r02.

All other types of emissions from the EUT shall meet the general limits for radiated frequencies outside the passband.

Refer to the attached test plots for out of band conducted emissions data with rate of 1Mbps for 802.11b and 6Mbps for 802.11g and 6Mbps for 802.11n-HT20 and 13.5Mbps for 802.11n-HT40.

The test plots showed all spurious emission up to the tenth harmonic were measured and they were found to be at least 20 dB below the highest level of the desired power in the passband.

Block Diagram:

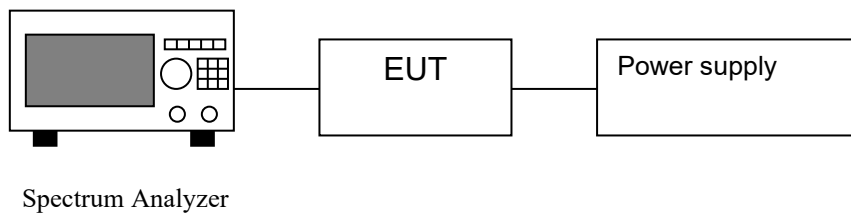

Test Result: Please refer the Appendix of 250218071SZN-002 Appendix D and Appendix of 250218071SZN-002 Appendix E.

Applicant: Guangzhou Xaircraft Technology CO.,LTD.

Date of Test: 27 February 2025

Model: 13IFC-5A

4.5 Out of Band Radiated Emissions (for emissions in 4.4 above that are less than 20dB below carrier), FCC Rule 15.247(d):

For out of band emissions that are close to or that exceed the 20dB attenuation requirement described in the specification, radiated measurements were performed at a 3m separation distance to determine whether these emissions complied with the general radiated emission requirement.

Not required, since all emissions are more than 20dB below fundamental

See attached data sheet

Applicant: Guangzhou Xaircraft Technology CO.,LTD.

Date of Test: 27 February 2025

Model: 13IFC-5A

4.6 Transmitter Radiated Emissions in Restricted Bands, FCC Rule 15.35(b) (c):

Data is included of the worst case configuration (the configuration which resulted in the highest emission levels). A sample calculation, configuration photographs and data tables of the emissions are included. All measurements were performed with peak detection unless otherwise specified.

The data on the following pages list the significant emission frequencies, the limit and the margin of compliance.

The Diagram below shows the test setup, which is utilized to make these measurements.

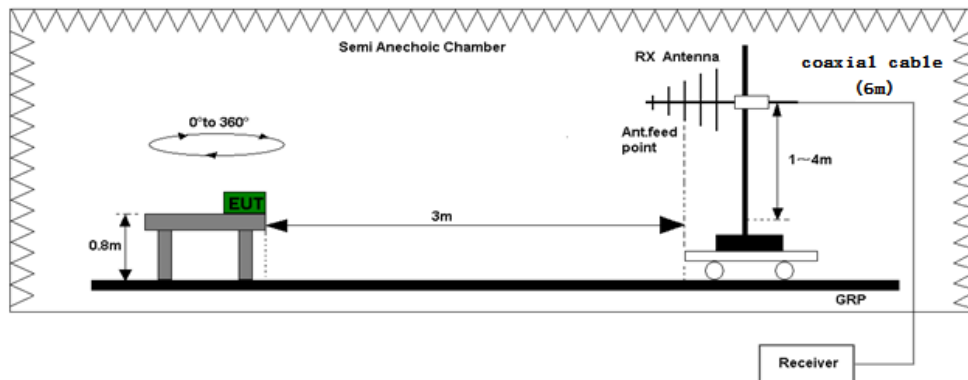

Test set-up of radiated disturbance (Up to 1GHz)

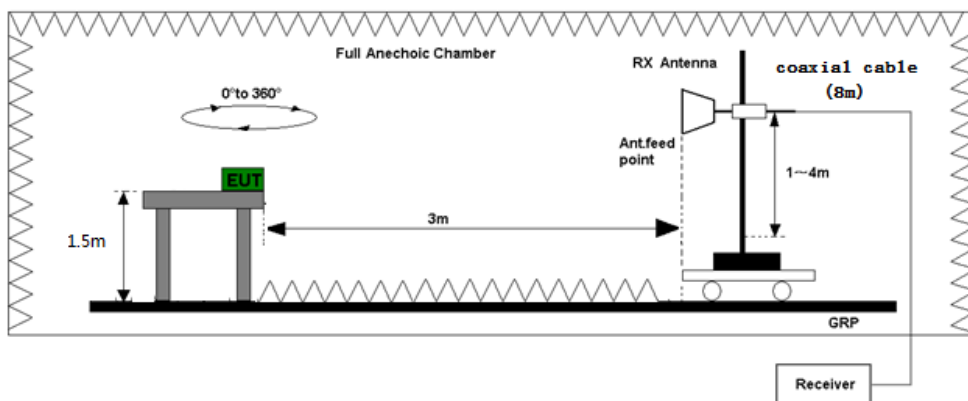

Test set-up of radiated disturbance (Above 1GHz)

Radiated emission measurements were performed from 9kHz to tenth harmonic or 40GHz. The EUT for testing is arranged on a styrene turntable. If some peripherals apply to the EUT, the peripherals will be connected to EUT and the whole system. During the test, all cables were arranged to produce worst-case emissions. The signal is maximized through rotation. The height of antenna and polarization is changing constantly for exploring for maximum signal level. The height of antenna can be up to 4 meters and down to 1 meter.

Applicant: Guangzhou Xaircraft Technology CO.,LTD.

Date of Test: 27 February 2025

Model: 13IFC-5A

4.7 Field Strength Calculation

The field strength is calculated by adding the reading on the Spectrum Analyzer to the factors associated with preamplifiers (if any), antennas, cables, pulse desensitization and average factors (when specified limit is in average and measurements are made with peak detectors). A sample calculation is included below.

$$FS = RA + AF + CF - AG + PD$$

Where

- FS = Field Strength in dB μ V/m
- RA = Receiver Amplitude (including preamplifier) in dB μ V
- CF = Cable Attenuation Factor in dB
- AF = Antenna Factor in dB
- AG = Amplifier Gain in dB
- PD = Pulse Desensitization in dB

In the radiated emission table which follows, the reading shown on the data table may reflect the preamplifier gain. An example of the calculations, where the reading does not reflect the preamplifier gain, follows:

$$FS = RA + AF + CF - AG + PD$$

Example

Assume a receiver reading of 62.0 dB μ V is obtained. The antenna factor of 7.4 dB and cable factor of 1.6 dB is added. The amplifier gain of 29 dB is subtracted. The pulse desensitization factor of the spectrum analyzer was 0 dB. The net field strength for comparison to the appropriate emission limit is 42 dB μ V/m. This value in dB μ V/m was converted to its corresponding level in μ V/m.

$$RA = 62.0 \text{ dB}\mu\text{V}$$

$$AF = 7.4 \text{ dB}$$

$$CF = 1.6 \text{ dB}$$

$$AG = 29.0 \text{ dB}$$

$$PD = 0 \text{ dB}$$

$$FS = 62 + 7.4 + 1.6 - 29 + 0 = 42 \text{ dB}\mu\text{V/m}$$

Level in mV/m = Common Antilogarithm [(42 dB μ V/m)/20] = 125.9 μ V/m

Applicant: Guangzhou Xaircraft Technology CO.,LTD.

Date of Test: 11 April 2025

Model: 13IFC-5A

4.8 Antenna information

N/A

4.9 Radiated Spurious Emission

The data on the following page lists the significant emission frequencies, the limit and the margin of compliance. Numbers with a minus sign are below the limit. Simultaneous transmission was considered during the test, only the worst case data is recorded in this report.

Worst Case Radiated Spurious Emission
at 2483.500MHz
is passed by 2.1dB margin.

For the electronic filing, the worst case radiated emission configuration photographs are saved with filename: radiated photos.pdf.

Applicant: Guangzhou Xaircraft Technology CO.,LTD.

Date of Test: 11 April 2025

Model: 13IFC-5A

Worst Case Operating Mode:

Transmit (2412MHz)

ANT Polarity: Horizontal

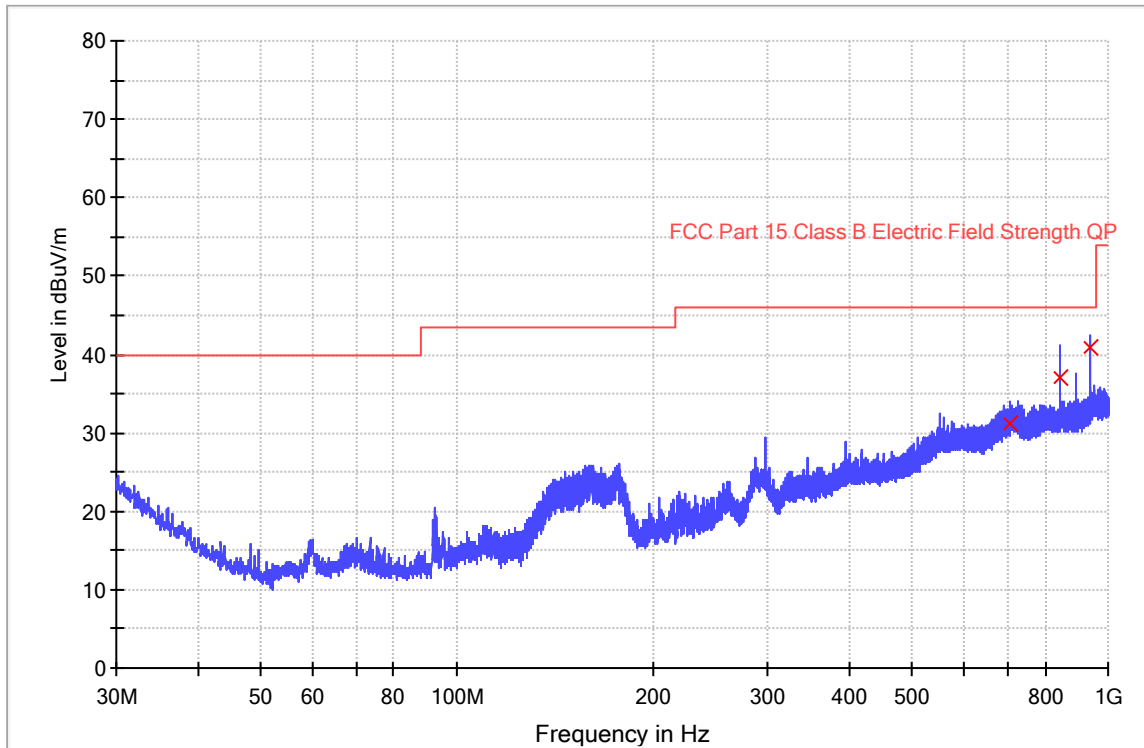

Frequency (MHz)	QuasiPeak (dBuV/m)	Meas. Time (ms)	Bandwidth (kHz)	Polarization	Corr. (dB/m)	Margin - QPK (dB)	Limit - QPK (dBuV/m)
709.032333	31.1	1000.0	120.000	H	30.9	14.9	46.0
841.502000	37.1	1000.0	120.000	H	31.9	8.9	46.0
940.506667	40.8	1000.0	120.000	H	33.4	5.2	46.0

Remark:

1. Corr. (dB/m) = Antenna Factor (dB/m) + Cable Loss (dB)
2. QuasiPeak (dBμV/m) = Corr. (dB/m) + Read Level (dBμV)
3. Margin (dB) = Limit Line (dBμV/m) – Level (dBμV/m)

Applicant: Guangzhou Xaircraft Technology CO.,LTD.

Date of Test: 11 April 2025

Model: 13IFC-5A

Worst Case Operating Mode:

Transmit (2412MHz)

ANT Polarity: Vertical

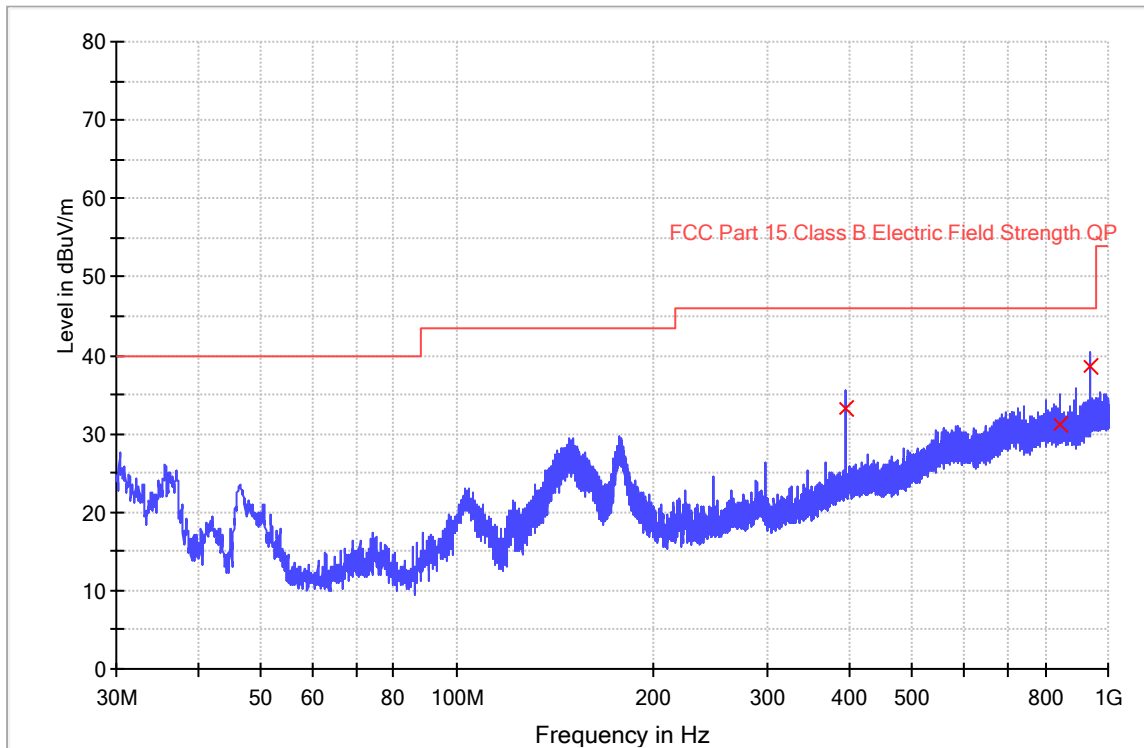

Frequency (MHz)	QuasiPeak (dBuV/m)	Meas. Time (ms)	Bandwidth (kHz)	Polarization	Corr. (dB/m)	Margin - QPK (dB)	Limit - QPK (dBuV/m)
395.981000	33.2	1000.0	120.000	V	25.4	12.8	46.0
841.469667	31.1	1000.0	120.000	V	31.9	14.9	46.0
940.474333	38.5	1000.0	120.000	V	33.4	7.5	46.0

Remark:

1. Corr. (dB/m) = Antenna Factor (dB/m) + Cable Loss (dB)
2. QuasiPeak (dBμV/m) = Corr. (dB/m) + Read Level (dBμV)
3. Margin (dB) = Limit Line (dBμV/m) – Level (dBμV/m)

Applicant: Guangzhou Xaircraft Technology CO.,LTD.

Date of Test: 11 April 2025

Model: 13IFC-5A

Radiated Emissions (above 1GHz)

Worst Case Operating Mode: Transmitting (802.11b-Channel 01)

Polarization	Frequency (MHz)	Reading (dBµV)	Pre-Amp Gain (dB)	Antenna Factor (dB)	Net at 3m (dBµV/m)	Peak Limit at 3m (dBµV/m)	Margin (dB)
Horizontal	*4824.000	54.7	36.8	33.5	51.4	74.0	-22.6
Horizontal	*2390.000	69.1	36.4	29.1	61.8	74.0	-12.2

Polarization	Frequency (MHz)	Reading (dBµV)	Pre-Amp Gain (dB)	Antenna Factor (dB)	Net at 3m (dBµV/m)	Average Limit at 3m (dBµV/m)	Margin (dB)
Horizontal	*4824.000	41.1	36.8	33.5	37.8	54.0	-16.2
Horizontal	*2390.000	57.4	36.4	29.1	50.1	54.0	-3.9

Worst Case Operating Mode: Transmitting (802.11b-Channel 06)

Polarization	Frequency (MHz)	Reading (dBµV)	Pre-Amp Gain (dB)	Antenna Factor (dB)	Net at 3m (dBµV/m)	Peak Limit at 3m (dBµV/m)	Margin (dB)
Horizontal	*4874.000	46.8	36.7	33.4	43.5	74.0	-30.5
Horizontal	*7311.000	46.7	36.6	35.8	45.9	74.0	-28.1

Polarization	Frequency (MHz)	Reading (dBµV)	Pre-Amp Gain (dB)	Antenna Factor (dB)	Net at 3m (dBµV/m)	Average Limit at 3m (dBµV/m)	Margin (dB)
Horizontal	*4874.000	36.2	36.7	33.4	32.9	54.0	-21.1
Horizontal	*7311.000	36.6	36.6	35.8	35.8	54.0	-18.2

Worst Case Operating Mode: Transmitting (802.11b-Channel 11)

Polarization	Frequency (MHz)	Reading (dBµV)	Pre-Amp Gain (dB)	Antenna Factor (dB)	Net at 3m (dBµV/m)	Peak Limit at 3m (dBµV/m)	Margin (dB)
Horizontal	*4924.000	53.7	36.8	33.3	50.2	74.0	-23.8
Horizontal	*2483.5	67.6	36.5	29.3	60.4	74.0	-13.6

Polarization	Frequency (MHz)	Reading (dBµV)	Pre-Amp Gain (dB)	Antenna Factor (dB)	Net at 3m (dBµV/m)	Average Limit at 3m (dBµV/m)	Margin (dB)
Horizontal	*4924.000	40.9	36.8	33.3	37.4	54.0	-16.6
Horizontal	*2483.5	57.1	36.5	29.3	49.9	54.0	-4.1

Worst Case Operating Mode: Transmitting (802.11g-Channel 01)

Polarization	Frequency (MHz)	Reading (dBμV)	Pre-Amp Gain (dB)	Antenna Factor (dB)	Net at 3m (dBμV/m)	Peak Limit at 3m (dBμV/m)	Margin (dB)
Horizontal	*4824.000	50.1	36.8	33.5	46.8	74.0	-27.2
Horizontal	*2390.000	73.4	36.4	29.1	66.1	74.0	-7.9

Polarization	Frequency (MHz)	Reading (dBμV)	Pre-Amp Gain (dB)	Antenna Factor (dB)	Net at 3m (dBμV/m)	Average Limit at 3m (dBμV/m)	Margin (dB)
Horizontal	*4824.000	37.6	36.8	33.5	34.3	54.0	-19.7
Horizontal	*2390.000	58.2	36.4	29.1	50.9	54.0	-3.1

Worst Case Operating Mode: Transmitting (802.11g-Channel 06)

Polarization	Frequency (MHz)	Reading (dBμV)	Pre-Amp Gain (dB)	Antenna Factor (dB)	Net at 3m (dBμV/m)	Peak Limit at 3m (dBμV/m)	Margin (dB)
Horizontal	*4874.000	51.8	36.7	33.4	48.5	74.0	-25.5
Horizontal	*7311.000	48.7	36.6	35.8	47.9	74.0	-26.1

Polarization	Frequency (MHz)	Reading (dBμV)	Pre-Amp Gain (dB)	Antenna Factor (dB)	Net at 3m (dBμV/m)	Average Limit at 3m (dBμV/m)	Margin (dB)
Horizontal	*4874.000	36.8	36.7	33.4	33.5	54.0	-20.5
Horizontal	*7311.000	38.6	36.6	35.8	37.8	54.0	-16.2

Worst Case Operating Mode: Transmitting (802.11g-Channel 11)

Polarization	Frequency (MHz)	Reading (dBμV)	Pre-Amp Gain (dB)	Antenna Factor (dB)	Net at 3m (dBμV/m)	Peak Limit at 3m (dBμV/m)	Margin (dB)
Horizontal	*4924.000	54.1	36.8	33.3	50.6	74.0	-23.4
Horizontal	*2483.500	76.7	36.5	29.3	69.5	74.0	-4.5

Polarization	Frequency (MHz)	Reading (dBμV)	Pre-Amp Gain (dB)	Antenna Factor (dB)	Net at 3m (dBμV/m)	Average Limit at 3m (dBμV/m)	Margin (dB)
Horizontal	*4924.000	40.1	36.8	33.3	36.6	54.0	-17.4
Horizontal	*2483.500	59.1	36.5	29.3	51.9	54.0	-2.1

Worst Case Operating Mode: Transmitting (802.11n20-Channel 01)

Polarization	Frequency (MHz)	Reading (dBμV)	Pre-Amp Gain (dB)	Antenna Factor (dB)	Net at 3m (dBμV/m)	Peak Limit at 3m (dBμV/m)	Margin (dB)
Horizontal	*4824.000	51.4	36.8	33.5	48.1	74.0	-25.9
Horizontal	*2390.000	73.9	36.4	29.1	66.6	74.0	-7.4

Polarization	Frequency (MHz)	Reading (dBμV)	Pre-Amp Gain (dB)	Antenna Factor (dB)	Net at 3m (dBμV/m)	Average Limit at 3m (dBμV/m)	Margin (dB)
Horizontal	*4824.000	36.6	36.8	33.5	33.3	54.0	-20.7
Horizontal	*2388.000	58.1	36.4	29.1	50.8	54.0	-3.2

Worst Case Operating Mode: Transmitting (802.11n20-Channel 06)

Polarization	Frequency (MHz)	Reading (dBμV)	Pre-Amp Gain (dB)	Antenna Factor (dB)	Net at 3m (dBμV/m)	Peak Limit at 3m (dBμV/m)	Margin (dB)
Horizontal	*4874.000	49.6	36.7	33.4	46.3	74.0	-27.7
Horizontal	*7311.000	48.1	36.6	35.8	47.3	74.0	-26.7

Polarization	Frequency (MHz)	Reading (dBμV)	Pre-Amp Gain (dB)	Antenna Factor (dB)	Net at 3m (dBμV/m)	Average Limit at 3m (dBμV/m)	Margin (dB)
Horizontal	*4874.000	38.0	36.7	33.4	34.7	54.0	-19.3
Horizontal	*7311.000	37.3	36.6	35.8	36.5	54.0	-17.5

Worst Case Operating Mode: Transmitting (802.11n20-Channel 11)

Polarization	Frequency (MHz)	Reading (dBμV)	Pre-Amp Gain (dB)	Antenna Factor (dB)	Net at 3m (dBμV/m)	Peak Limit at 3m (dBμV/m)	Margin (dB)
Horizontal	*4924.000	53.7	36.8	33.3	50.2	74.0	-23.8
Horizontal	*2483.500	74.0	36.5	29.3	66.8	74.0	-7.2

Polarization	Frequency (MHz)	Reading (dBμV)	Pre-Amp Gain (dB)	Antenna Factor (dB)	Net at 3m (dBμV/m)	Average Limit at 3m (dBμV/m)	Margin (dB)
Horizontal	*4924.000	39.3	36.8	33.3	35.8	54.0	-18.2
Horizontal	*2483.500	57.2	36.5	29.3	50.0	54.0	-4.0

- NOTES:
1. Peak detector is used, RBW=1MHz/VBW=3MHz for peak value. Average detector is used, RBW=1MHz/VBW=10Hz for average value.
 2. All measurements were made at 3 meters. Radiated emissions not detected at the 3-meter distance were measured at 0.3-meter and an inverse proportional extrapolation was performed to compare the signal level to the 3-meter limit. No other radiated emissions than those reported were detected at a test distance of 0.3-meter.
 3. Negative value in the margin column shows emission below limit.
 4. Horn antenna used for the emission over 1000MHz.
- * Emission within the restricted band meets the requirement of section 15.205. The corresponding limit as per 15.209 is based on Quasi peak limit for frequencies below 1000 MHz and average limit for frequencies over 1000 MHz. The radio frequency emissions above 1GHz also meet corresponding 20dB permitted peak limit with a peak detector function.

Applicant: Guangzhou Xaircraft Technology CO.,LTD.

Date of Test: 21 April 2025

Model: 13IFC-5A

4.10 Conducted Emission

Block Diagram:

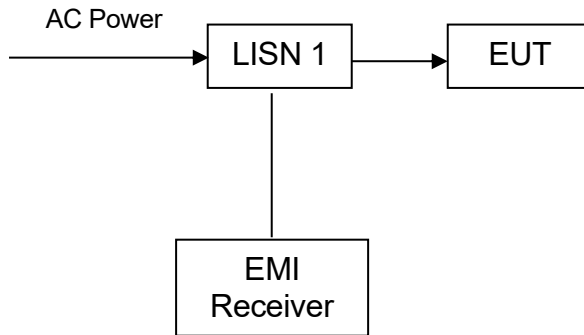

For tabletop equipment, the EUT along with its peripherals were placed on a 1.0m(W)×1.5m(L) and 0.8m in height wooden table. The EUT was adjusted to maintain a 0.4 meter space from a vertical reference plane. The EUT was connected to power mains through a line impedance stabilization network (LISN), which provided 50 ohm coupling impedance for measuring instrument and the chassis ground was bounded to the horizontal ground plane of shielded room. The excess power cable between the EUT and the LISN was bundled

Simultaneous transmission was considered during the test, only the worst case data is recorded in this report.

Worst Case Conducted Emission
at 13.13MHz
is passed by 29.2dB margin.

For the electronic filing, the worst case radiated emission configuration photographs are saved with filename: conducted photos.pdf.

Applicant: Guangzhou Xaircraft Technology CO.,LTD.
Date of Test: 21 April 2025 Model: 13IFC-5A
Worst Case Operating Mode: Transmit (2412MHz)
Phase: Live

Graphic / Data Table

Conducted Emissions Pursuant to FCC 15.207: Emissions Requirement

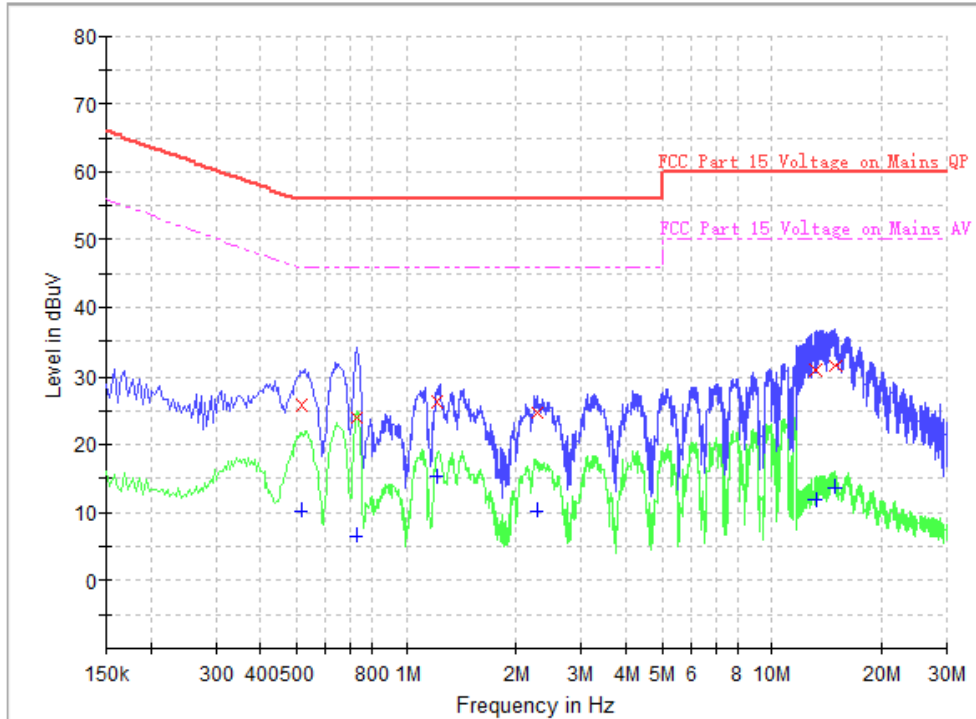

Limit and Margin QP

Frequency (MHz)	QuasiPeak (dBuV)	Bandwidth (kHz)	Line	Corr. (dB)	Margin (dB)	Limit (dBuV)
0.518000	25.6	9.000	L1	9.5	30.4	56.0
0.734000	23.9	9.000	L1	9.4	32.1	56.0
1.222000	26.3	9.000	L1	9.4	29.7	56.0
2.270000	24.6	9.000	L1	9.4	31.4	56.0
13.130000	30.8	9.000	L1	9.7	29.2	60.0
14.942000	31.5	9.000	L1	9.8	28.5	60.0

Limit and Margin AV

Frequency (MHz)	Average (dBuV)	Bandwidth (kHz)	Line	Corr. (dB)	Margin (dB)	Limit (dBuV)
0.518000	25.6	9.000	L1	9.5	35.7	46.0
0.734000	23.9	9.000	L1	9.4	39.5	46.0
1.222000	26.3	9.000	L1	9.4	30.7	46.0
2.270000	24.6	9.000	L1	9.4	35.8	46.0
13.130000	30.8	9.000	L1	9.7	38.1	50.0
14.942000	31.5	9.000	L1	9.8	36.3	50.0

Remark:

1. Corr. Factor (dB) = LISN Factor (dB) + Cable Loss (dB)
2. Margin (dB) = Limit (dBuV) – Level (dBuV)

Applicant: Guangzhou Xaircraft Technology CO.,LTD.
Date of Test: 21 April 2025 Model: 13IFC-5A
Worst Case Operating Mode: Transmit (2412MHz)
Phase: Neutral

Graphic / Data Table

Conducted Emissions Pursuant to FCC 15.207: Emissions Requirement

Conducted Emission Test - EN55032

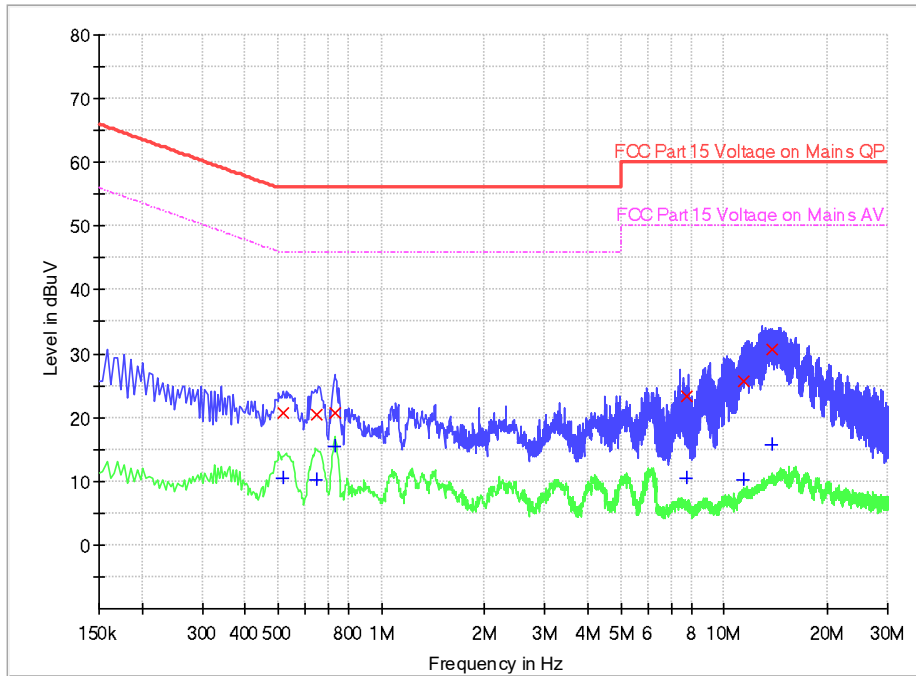

Limit and Margin QP

Frequency (MHz)	QuasiPeak (dBuV)	Bandwidth (kHz)	Line	Corr. (dB)	Margin (dB)	Limit (dBuV)
0.518000	20.7	9.000	N	9.6	35.3	56.0
0.646000	20.4	9.000	N	9.6	35.6	56.0
0.734000	20.7	9.000	N	9.6	35.3	56.0
7.774000	23.4	9.000	N	9.7	36.6	60.0
11.450000	25.8	9.000	N	9.8	34.2	60.0
13.754000	30.7	9.000	N	10.0	29.3	60.0

Limit and Margin AV

Frequency (MHz)	Average (dBuV)	Bandwidth (kHz)	Line	Corr. (dB)	Margin (dB)	Limit (dBuV)
0.518000	10.5	9.000	N	9.6	35.5	46.0
0.646000	10.3	9.000	N	9.6	35.7	46.0
0.734000	15.4	9.000	N	9.6	30.6	46.0
7.774000	10.4	9.000	N	9.7	39.6	50.0
11.450000	10.3	9.000	N	9.8	39.7	50.0
13.754000	15.7	9.000	N	10.0	34.3	50.0

Remark:

1. Corr. Factor (dB) = LISN Factor (dB) + Cable Loss (dB)
2. Margin (dB) = Limit (dBuV) – Level (dBuV)

Applicant: Guangzhou Xaircraft Technology CO.,LTD.

Date of Test: 27 February 2025

Model: 13IFC-5A

4.11 Radiated Emissions from Digital Section of Transceiver, FCC Ref: 15.109

- Not required - No digital part
- Test results are attached
- Included in the separated report.

4.12 Transmitter Duty Cycle Calculation and Measurements, FCC Rule 15.35(b), (c)

The EUT antenna output port was connected to the input of the spectrum analyzer. The analyzer center frequency was set to EUT RF channel carrier. The SWEP function on the analyzer was set to ZERO SPAN. The Transmitter ON time was determined from the resultant time-amplitude display:

	See attached spectrum analyzer chart (s) for Transmitter timing
	See Transmitter timing diagram provided by manufacturer
x	Not applicable, duty cycle was not used.

5.0 Equipment Photographs

For electronic filing, the photographs are saved with filename: external photos.pdf & internal photos.pdf.

6.0 Product Labeling

For electronic filing, the FCC ID label artwork and location is saved with filename: label.pdf.

7.0 Technical Specifications

For electronic filing, the block diagram and circuit diagram are saved with filename: block.pdf and circuit.pdf respectively.

8.0 Instruction Manual

For electronic filing, a preliminary copy of the Instruction Manual is saved with filename: manual.pdf.

This manual will be provided to the end-user with each unit sold/leased in the United States.

9.0 Confidentiality Request

For electronic filing, the confidentiality request of the tested EUT is saved with filename: request.pdf.

10.0 Discussion of Pulse Desensitization

The determination of pulse desensitivity was made in accordance with Hewlett Packard Application Note 150-2, *Spectrum Analysis ... Pulsed RF*.

Pulse desensitivity is not applicable for this device since the transmitter transmits the RF signal continuously.

11.0 Test Equipment List

Equipment No.	Equipment	Manufacturer	Model No.	Serial No.	Cal. Date	Due Date
SZ182-02	RF Power Meter	Anritsu	ML2496A	1302005	2024-04-22	2025-04-22
SZ182-02-01	Power Sensor	Anritsu	MA2411B	1207429	2024-04-22	2025-04-22
SZ061-13	BiConiLog Antenna	ETS	3142E	00217919	2022-07-13	2025-07-13
SZ185-03	EMI Receiver	R&S	ESCI	101975	2024-04-23	2025-04-23
SZ061-08	Horn Antenna	ETS	3115	00092346	2024-09-13	2027-09-13
SZ061-06	Active Loop Antenna	Electro-Metrics	EM-6876	217	2024-05-05	2027-05-05
SZ056-03	Spectrum Analyzer	R&S	FSP 30	101148	2024-04-22	2025-04-22
SZ056-08	Signal Analyzer	R&S	FSV 40	101430	2024-12-06	2025-12-06
SZ181-04	Preamplifier	Agilent	8449B	3008A02474	2024-04-22	2025-04-22
SZ188-01	Anechoic Chamber	ETS	RFD-F/A-100	4102	2021-12-12	2026-12-12
SZ062-24	RF Cable	RADIALL	RG 213U	--	2024-09-30	2025-09-30
SZ062-25	RF Cable	RADIALL	0.04-26.5GHz	--	2024-09-30	2025-09-30
SZ062-38	RF Cable	RADIALL	0.04-26.5GHz	--	2024-09-30	2025-09-30
SZ067-04	Notch Filter	Micro-Tronics	BRM50702-02	--	2024-04-23	2025-04-23
SZ185-02	EMI Test Receiver	R&S	ESCI	100692	2024-07-09	2025-07-09
SZ187-02	Two-Line V-Network	R&S	ENV216	100073	2024-04-23	2025-04-23
SZ188-03	Shielding Room	ETS	RFD-100	4100	2022-12-20	2025-12-20

***** End of Report*****