

# FCC RADIO TEST REPORT

## FCC ID: 2A3JZ-AM171

**Product :** rugged tablet  
**Trade Mark :** RAGTAB  
**Model Name :** AM171-RD86  
**Family Model :** AM171-RD86QE, AM181-Rugged PadM81,  
AM181-RD81PT  
**Report No. :** S21112401503007

### Prepared for

Alutel Corp

20900 NE 30th Ave Suite 200, Aventura FL 33180, USA

### Prepared by

Shenzhen NTEK Testing Technology Co., Ltd.  
1/F, Building E, Fenda Science Park, Sanwei Community,  
Xixiang Street Bao'an District, Shenzhen 518126 P.R. China  
Tel. 400-800-6106, 0755-2320 0050, 0755-2320 0090  
Website: <http://www.ntek.org.cn>

### TEST RESULT CERTIFICATION

**Applicant's name** ..... : Alutel Corp  
Address ..... : 20900 NE 30th Ave Suite 200, Aventura FL 33180, USA  
**Manufacturer's Name** ..... : Altimec Sa.  
Address ..... : Miguelete 1664 Montevideo - Uruguay

**Product description**

Product name..... : rugged tablet  
Model and/or type reference : AM171-RD86  
Family Model: AM171-RD86QE, AM181-Rugged PadM81, AM181-RD81PT

**Standards** ..... : FCC Part15.225

Test procedure..... ANSI C63.10-2013

This device described above has been tested by NTEK, and the test results show that the equipment under test (EUT) is in compliance with the FCC requirements. And it is applicable only to the tested sample identified in the report.

This report shall not be reproduced except in full, without the written approval of NTEK, this document may be altered or revised by NTEK, personnel only, and shall be noted in the revision of the document.

**Date of Test**..... :

Date (s) of performance of tests..... : 24 Nov. 2021 ~30 Dec, 2021

Date of Issue..... : 31 Dec, 2021

Test Result..... : **Pass**

Testing Engineer :   
\_\_\_\_\_  
(Mary Hu)

Authorized Signatory :   
\_\_\_\_\_  
(Alex Li)

**Table of Contents**

**Page**

<b>1 . SUMMARY OF TEST RESULTS</b>	<b>4</b>
1.1 TEST FACILITY	5
1.2 MEASUREMENT UNCERTAINTY	5
<b>2 . GENERAL INFORMATION</b>	<b>6</b>
2.1 GENERAL DESCRIPTION OF EUT	6
2.2 DESCRIPTION OF TEST MODES	7
2.3 BLOCK DIGRAM SHOWING THE CONFIGURATION OF SYSTEM TESTED	8
2.4 DESCRIPTION OF SUPPORT UNITS (CONDUCTED MODE)	9
2.5 EQUIPMENTS LIST FOR ALL TEST ITEMS	10
<b>3 . ANTENNA REQUIREMENT</b>	<b>11</b>
3.1 STANDARD REQUIREMENT	11
3.2 EUT ANTENNA	11
<b>4 . EMC EMISSION TEST</b>	<b>12</b>
4.1 CONDUCTED EMISSION MEASUREMENT	12
4.1.1 POWER LINE CONDUCTED EMISSION LIMITS	12
4.1.2 TEST CONFIGURATION	12
4.1.3 TEST PROCEDURE	12
4.1.4 TEST RESULT	13
4.2 RADIATED EMISSION MEASUREMENT	15
4.2.1 RADIATED EMISSION LIMITS	15
4.2.2 TEST PROCEDURE	16
4.2.3 DEVIATION FROM TEST STANDARD	16
4.2.4 TEST SETUP	17
4.2.5 TEST RESULTS (BELOW 30MHZ)	18
4.2.6 TEST RESULTS (BETWEEN 30 – 1000 MHZ)	22
<b>5 . BANDWIDTH TEST</b>	<b>24</b>
5.1 TEST PROCEDURE	24
5.2 DEVIATION FROM STANDARD	24
5.3 TEST SETUP	24
5.4 TEST RESULTS	25
<b>6. FREQUENCY TOLERANCE</b>	<b>26</b>

### 1. SUMMARY OF TEST RESULTS

Test procedures according to the technical standards:

FCC Part15, Subpart C (15.225)			
Standard Section	Test Item	Judgment	Remark
15.207	Conducted Emission	Pass	
15.205(a) 15.209 15.225(abcd)	Radiated Spurious Emission	Pass	
15.225 15.215(c)	20dB Bandwidth	Pass	
15.225(e)	Frequency Tolerance	Pass	
15.203	Antenna Requirement	Pass	

**NOTE:**

(1) "N/A" denotes test is not applicable in this Test Report.

**1.1 TEST FACILITY**

All measurement facilities used to collect the measurement data are located at 1/F, Building E, Fenda Science Park, Sanwei Community, Xixiang Street, Bao'an District, Shenzhen 518126 P.R. China.

The sites are constructed in conformance with the requirements of ANSI C63.7, ANSI C63.10 and CISPR Publication 22.

Site Description

CNAS-Lab. : The Certificate Registration Number is L5516.

IC-Registration : The Certificate Registration Number is 9270A.  
CAB identifier:CN0074

FCC- Accredited : Test Firm Registration Number: 463705.  
Designation Number: CN1184

A2LA-Lab. : The Certificate Registration Number is 4298.01

Name of Firm : Shenzhen NTEK Testing Technology Co., Ltd.

Site Location : 1/F, Building E, Fenda Science Park, Sanwei Community,  
Xixiang Street, Bao'an District, Shenzhen 518126 P.R. China.

**1.2 MEASUREMENT UNCERTAINTY**

The reported uncertainty of measurement  $y \pm U$ , where expended uncertainty  $U$  is based on a standard uncertainty multiplied by a coverage factor of  $k=2$ , providing a level of confidence of approximately **95 %**.

No.	Item	Uncertainty
1	Conducted Emission Test	$\pm 1.38\text{dB}$
2	RF power,conducted	$\pm 0.16\text{dB}$
3	Spurious emissions,conducted	$\pm 0.21\text{dB}$
4	All emissions,radiated(<1G)	$\pm 4.68\text{dB}$
5	All emissions,radiated(>1G)	$\pm 4.89\text{dB}$
6	Temperature	$\pm 0.5^\circ\text{C}$
7	Humidity	$\pm 2\%$

**2. GENERAL INFORMATION**

**2.1 GENERAL DESCRIPTION OF EUT**

Equipment	rugged tablet	
Trade Mark	RAGTAB	
Model Name	AM171-RD86	
Family Model	AM171-RD86QE, AM181-Rugged PadM81, AM181-RD81PT	
Model Difference	All models are the same circuit and RF module, except the Model name.	
Product Description	The EUT is a rugged tablet	
	Operation Frequency:	13.56MHz
	Modulation Type:	ASK
	Number Of Channel	1CH.
	Antenna Designation:	Induction coil
Adapter	Model:AW018WR-0500300UH Input: 100-240V~50/60Hz 0.5A Output: 5.0V---3.0A	
Rating	DC 3.7V/8500mAh from battery or DC 5V from Adapter.	
HW Version	EM_Q86_MB_PCB	
SW Version	andriod 10	

Note:

1. For a more detailed features description, please refer to the manufacturer's specifications or the User's Manual.

2.

Table for Filed Antenna

Ant	Brand	Model Name	Antenna Type	Connector	Gain (dBi)	NOTE
1	N/A	N/A	Induction coil	N/A	N/A	Antenna

## 2.2 DESCRIPTION OF TEST MODES

To investigate the maximum EMI emission characteristics generates from EUT, the test system was pre-scanning tested base on the consideration of following EUT operation mode or test configuration mode which possible have effect on EMI emission level. Each of these EUT operation mode(s) or test configuration mode(s) mentioned above was evaluated respectively.

Pretest Mode	Description
Mode 1	TX-13.56MHz

For Conducted Emission	
Final Test Mode	Description
Mode 1	TX-13.56MHz

For Radiated Emission	
Final Test Mode	Description
Mode 1	TX-13.56MHz

### 2.3 BLOCK DIGRAM SHOWING THE CONFIGURATION OF SYSTEM TESTED

For AC Conducted Emission Mode

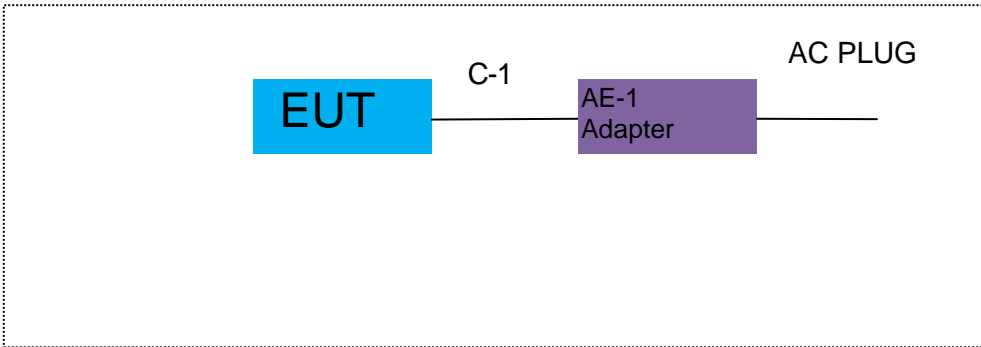

For Radiated Test Cases

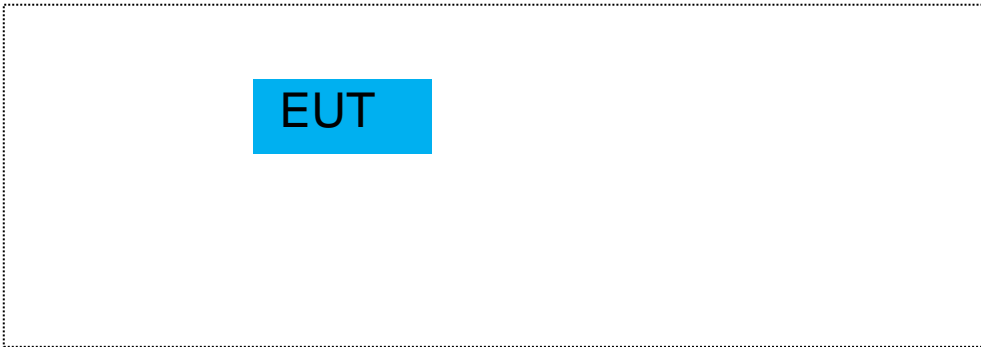

For Conducted Test Cases

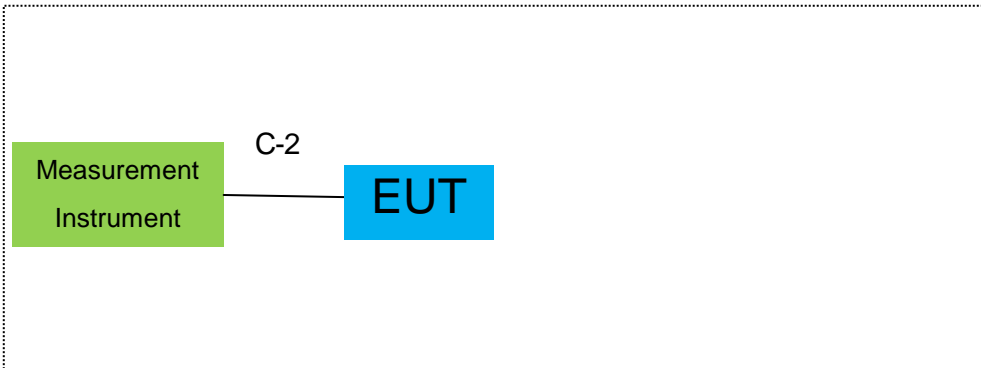

Note: 1.The temporary antenna connector is soldered on the PCB board in order to perform conducted tests and this temporary antenna connector is listed in the equipment list.  
 2.EUT built-in battery-powered, the battery is fully-charged.



**2.4 DESCRIPTION OF SUPPORT UNITS (CONDUCTED MODE)**

The EUT has been tested as an independent unit together with other necessary accessories or support units. The following support units or accessories were used to form a representative test configuration during the tests.

Item	Equipment	Model/Type No.	Series No.	Note
AE-1	Adapter	AW018WR-0500300UH	N/A	Peripherals

Item	Cable Type	Shielded Type	Ferrite Core	Length	Note
C-1	DC Cable	YES	YES	1.0m	
C-2	RF Cable	YES	NO	0.1m	

Note:

- (1) The support equipment was authorized by Declaration of Confirmation.
- (2) For detachable type I/O cable should be specified the length in cm in 『Length』 column.

## 2.5 EQUIPMENTS LIST FOR ALL TEST ITEMS

### Radiation& Conducted Test equipment

Item	Kind of Equipment	Manufacturer	Type No.	Serial No.	Last calibration	Calibrated until	Calibration period
1	Spectrum Analyzer	Agilent	E4407B	MY45108040	2021.04.27	2022.04.26	1 year
2	Spectrum Analyzer	Agilent	N9020A	MY49100060	2021.04.27	2022.04.26	1 year
3	Spectrum Analyzer	R&S	FSV40	101417	2021.07.01	2022.06.30	1 year
4	Test Receiver	R&S	ESPI7	101318	2021.04.27	2022.04.26	1 year
5	Bilog Antenna	TESEQ	CBL6111D	31216	2021.03.29	2022.03.28	1 year
6	50Ω Coaxial Switch	Anritsu	MP59B	6200983705	2020.05.11	2023.05.10	3 year
7	Horn Antenna	EM	EM-AH-10180	2011071402	2021.03.29	2022.03.28	1 year
8	Active Loop Antenna	SCHWARZBECK	FMZB 1519B	055	2021.07.01	2022.06.30	1 year
9	LF Cable	N/A	R-03	N/A	2020.05.11	2023.05.10	3 year
10	PSG Analog Signal Generator	Agilent	E8257D	MY51110112	2021.07.01	2022.06.30	1 year
11	Test Cable (9KHz-30MHz)	N/A	R-01	N/A	2020.05.11	2023.05.10	3 year
12	Test Cable (30MHz-1GHz)	N/A	R-02	N/A	2020.05.11	2023.05.10	3 year

### AC Conduction Test equipment

Item	Kind of Equipment	Manufacturer	Type No.	Serial No.	Last calibration	Calibrated until	Calibration period
1	Test Receiver	R&S	ESCI	101160	2021.04.27	2022.04.26	1 year
2	LISN	R&S	ENV216	101313	2021.04.27	2022.04.26	1 year
3	LISN	SCHWARZBECK	NNLK 8129	8129245	2021.04.27	2022.04.26	1 year
4	50Ω Coaxial Switch	ANRITSU CORP	MP59B	6200983704	2020.05.11	2023.05.10	3 year
5	Test Cable (9KHz-30MHz)	N/A	C01	N/A	2020.05.11	2023.05.10	3 year
6	Test Cable (9KHz-30MHz)	N/A	C02	N/A	2020.05.11	2023.05.10	3 year
7	Test Cable (9KHz-30MHz)	N/A	C03	N/A	2020.05.11	2023.05.10	3 year

Note:

- 1.We will use the temporary antenna connector (soldered on the PCB board) When conducted test And this temporary antenna connector is listed within the instrument list
2. Each piece of equipment is scheduled for calibration once a year except the Test Cable& Aux Equipment which is scheduled for calibration every 3 years.

### **3. ANTENNA REQUIREMENT**

#### **3.1 STANDARD REQUIREMENT**

15.203 requirement: For intentional device, according to 15.203: an intentional radiator shall be designed to ensure that no antenna other than that furnished by the responsible party shall be used with the device.

#### **3.2 EUT ANTENNA**

The EUT antenna is permanent attached antenna. It comply with the standard requirement.

## 4. EMC EMISSION TEST

### 4.1 CONDUCTED EMISSION MEASUREMENT

#### 4.1.1 POWER LINE CONDUCTED EMISSION Limits (Frequency Range 150KHz-30MHz)

Frequency(MHz)	Conducted Emission Limit	
	Quasi-peak	Average
0.15-0.5	66-56*	56-46*
0.5-5.0	56	46
5.0-30.0	60	50

Note: 1. \*Decreases with the logarithm of the frequency  
 2. The lower limit shall apply at the transition frequencies  
 3. The limit decreases in line with the logarithm of the frequency in the range of 0.15 to 0.50MHz.

#### 4.1.2 TEST CONFIGURATION

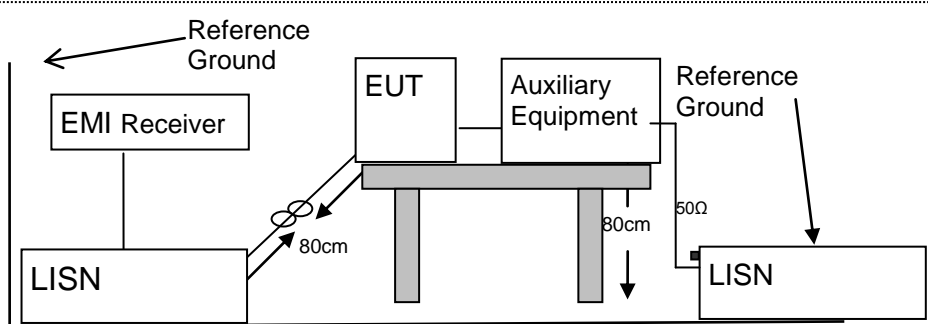

#### 4.1.3 TEST PROCEDURE

According to the requirements in Section 13.1.4.1 of ANSI C63.10-2013 Conducted emissions the EUT measured in the frequency range between 0.15 MHz and 30 MHz using CISPR Quasi-Peak and average detector mode.

1. The EUT was placed 0.4 meter from the conducting wall of the shielding room.
2. The EUT was placed on a table which is 0.8m above ground plane.
3. Connect EUT to the power mains through a line impedance stabilization network (LISN). All other support equipments powered from additional LISN(s). The LISN provide 50 Ohm/ 50uH of coupling impedance for the measuring instrument.
4. Interconnecting cables that hang closer than 40 cm to the ground plane shall be folded back and forth in the center forming a bundle 30 to 40cm long.
5. I/O cables that are not connected to a peripheral shall be bundled in the center. The end of the cable may be terminated, if required, using the correct terminating impedance. The overall length shall not exceed 1 m.
6. LISN at least 80 cm from nearest part of EUT chassis.
7. The frequency range from 150KHz to 30MHz was searched.
8. Set the test-receiver system to Peak Detect Function and specified bandwidth(IF bandwidth=9KHz) with Maximum Hold Mode
9. For the actual test configuration, please refer to the related Item –EUT Test Photos.

4.1.4 TEST RESULT

EUT :	rugged tablet	Model Name :	AM171-RD86
Temperature :	24 °C	Relative Humidity :	54%
Pressure :	1010hPa	Phase :	L
Test Voltage :	DC 5V from Adapter AC 120V/60Hz	Test Mode :	Mode 1

Frequency (MHz)	Reading Level (dBμV)	Correct Factor (dB)	Measure-ment (dBμV)	Limits (dBμV)	Margin (dB)	Remark
0.1660	43.84	9.63	53.47	65.15	-11.68	QP
0.1660	7.45	9.63	17.08	55.15	-38.07	AVG
0.5540	26.99	9.71	36.70	56.00	-19.30	QP
0.5580	14.29	9.71	24.00	46.00	-22.00	AVG
0.6780	26.31	9.65	35.96	56.00	-20.04	QP
0.6780	13.15	9.65	22.80	46.00	-23.20	AVG
0.9579	24.77	9.74	34.51	56.00	-21.49	QP
0.9579	11.66	9.74	21.40	46.00	-24.60	AVG
7.4858	31.63	9.80	41.43	60.00	-18.57	QP
7.4858	24.19	9.80	33.99	50.00	-16.01	AVG
9.4498	31.23	9.81	41.04	60.00	-18.96	QP
9.4498	22.04	9.81	31.85	50.00	-18.15	AVG

Remark:

1. All readings are Quasi-Peak and Average values.
2. Factor = Insertion Loss + Cable Loss.

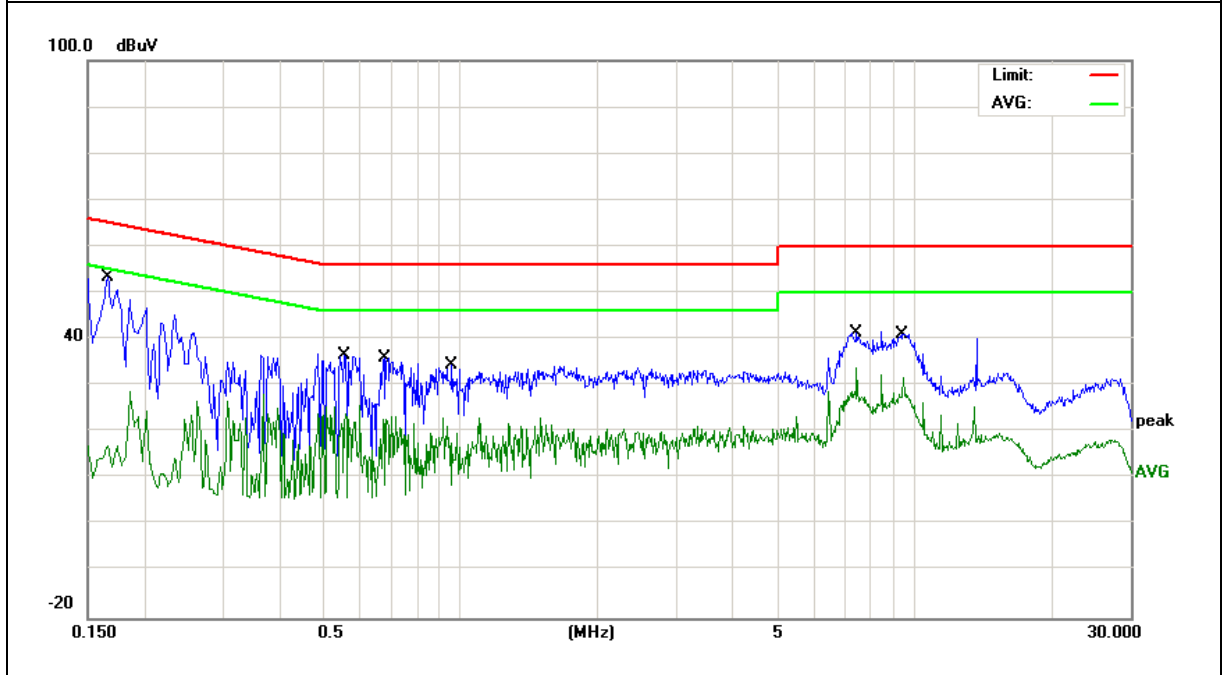

EUT :	rugged tablet	Model Name :	AM171-RD86
Temperature :	24 °C	Relative Humidity :	54%
Pressure :	1010hPa	Phase :	N
Test Voltage :	DC 5V from Adapter AC 120V/60Hz	Test Mode :	Mode 1

Frequency (MHz)	Reading Level (dBμV)	Correct Factor (dB)	Measure-ment (dBμV)	Limits (dBμV)	Margin (dB)	Remark
0.1660	40.90	9.63	50.53	65.15	-14.62	QP
0.1660	8.04	9.63	17.67	55.15	-37.48	AVG
0.4818	27.36	9.73	37.09	56.31	-19.22	QP
0.4818	16.80	9.73	26.53	46.31	-19.78	AVG
0.7098	25.06	9.64	34.70	56.00	-21.30	QP
0.7098	15.84	9.64	25.48	46.00	-20.52	AVG
0.9498	24.46	9.73	34.19	56.00	-21.81	QP
0.9498	12.70	9.73	22.43	46.00	-23.57	AVG
7.4858	33.35	9.80	43.15	60.00	-16.85	QP
7.4858	22.38	9.80	32.18	50.00	-17.82	AVG
9.5579	30.78	9.81	40.59	60.00	-19.41	QP
9.5579	20.50	9.81	30.31	50.00	-19.69	AVG

Remark:

1. All readings are Quasi-Peak and Average values.
2. Factor = Insertion Loss + Cable Loss.

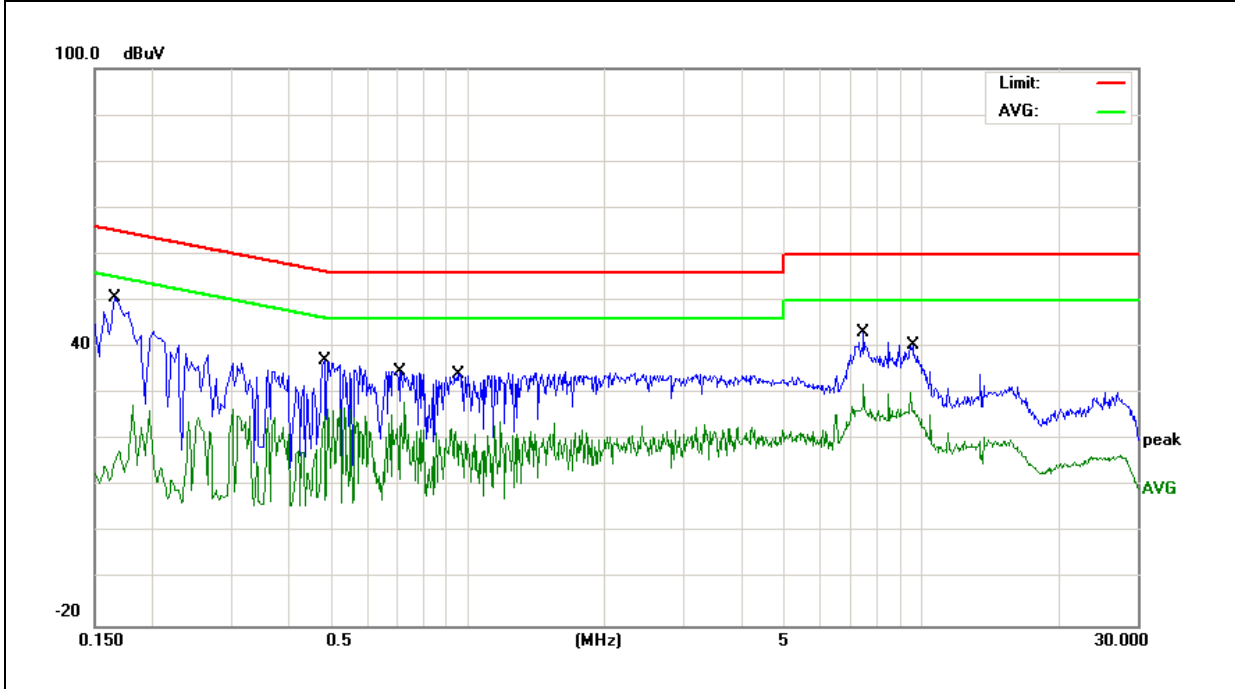

**4.2 RADIATED EMISSION MEASUREMENT**

**4.2.1 Radiated Emission Limits ( FCC 15.209 )**

Frequencies (MHz)	Field Strength (microrvolts/meter)	Measurement Distance (meters)
0.009~0.490	2400/F(KHz)	300
0.490~1.705	24000/F(KHz)	30
1.705~30.0	30	30
30~88	100	3
88~216	150	3
216~960	200	3
Above 960	500	3

Note:

- (1) The tighter limit applies at the band edges.
- (2) Emission level (dBuV/m)=20log Emission level (uV/m).

According to FCC Part 15.247(d): radiated emissions which fall in the restricted bands, as defined in §15.205(a) must also comply with the radiated emission limits specified in §15.209(a) (see §15.205(c)).  
According to FCC Part 15.205, Restricted bands

MHz	MHz	MHz	GHz
0.090-0.110	16.42-16.423	399.9-410	4.5-5.15
10.495-0.505	16.69475-16.69525	608-614	5.35-5.46
2.1735-2.1905	16.80425-16.80475	960-1240	7.25-7.75
4.125-4.128	25.5-25.67	1300-1427	8.025-8.5
4.17725-4.17775	37.5-38.25	1435-1626.5	9.0-9.2
4.20725-4.20775	73-74.6	1645.5-1646.5	9.3-9.5
6.215-6.218	74.8-75.2	1660-1710	10.6-12.7
6.26775-6.26825	123-138	2200-2300	14.47-14.5
8.291-8.294	149.9-150.05	2310-2390	15.35-16.2
8.362-8.366	156.52475-156.52525	2483.5-2500	17.7-21.4
8.37625-8.38675	156.7-156.9	2690-2900	22.01-23.12
8.41425-8.41475	162.0125-167.17	3260-3267	23.6-24.0
12.29-12.293	167.72-173.2	3332-3339	31.2-31.8
12.51975-12.52025	240-285	3345.8-3358	36.43-36.5
12.57675-12.57725	322-335.4	3600-4400	(2)
13.36-13.41			

**LIMITS OF RADIATED EMISSION MEASUREMENT ( FCC 15.225)**

- (a) The field strength of any emissions within the band 13.553-13.567 MHz shall not exceed 15,848 microvolts/meter at 30 meters, equal to 124dBuV/m at 3 meters.
- (b) Within the bands 13.410-13.553 MHz and 13.567-13.710 MHz, the field strength of any emissions shall not exceed 334 microvolts/meter at 30 meters, equal to 90.5dBuV/m at 3 meters.
- (c) Within the bands 13.110-13.410 MHz and 13.710-14.010 MHz the field strength of any emissions shall not exceed 106 microvolts/meter at 30 meters, equal to 80.5dBuV/m at 3 meters..
- (d) The field strength of any emissions appearing outside of the 13.110-14.010 MHz band shall not exceed the general radiated emission limits in § 15.209.

Spectrum Parameter	Setting
Attenuation	Auto
Start Frequency	1000 MHz
Stop Frequency	10th carrier harmonic
RB / VB (emission in restricted band)	1MHz / 1MHz for Peak

Receiver Parameter	Setting
Attenuation	Auto
Start ~ Stop Frequency	9kHz~150kHz / RB 200Hz for QP
Start ~ Stop Frequency	150kHz~30MHz / RB 9kHz for QP
Start ~ Stop Frequency	30MHz~1000MHz / RB 120kHz for QP

**4.2.2 TEST PROCEDURE**

- a. The measuring distance of at 3 m shall be used for measurements at frequency up to 1GHz And above 1GHz,
- b. The EUT was placed on the top of a rotating table 0.8 meters above the ground at a 3m meter. The table was rotated 360 degrees to determine the position of the highest radiation.
- c. The height of the equipment or of the substitution antenna shall be 0.8 m; the height of the test antenna shall vary between 1 m to 4 m.
- d. The initial step in collecting conducted emission data is a spectrum analyzer peak detector mode pre-scanning the measurement frequency range. Significant peaks are then marked and then Quasi Peak detector mode re-measured.
- e. If the Peak Mode measured value compliance with and lower than Quasi Peak Mode Limit, the EUT shall be deemed to meet QP Limits and then no additional QP Mode measurement performed.
- f. For the actual test configuration, please refer to the related Item –EUT Test Photos.

Note:

Both horizontal and vertical antenna polarities were tested and performed pretest to three orthogonal axis. The worst case emissions were reported

**4.2.3 DEVIATION FROM TEST STANDARD**

No deviation



4.2.4 TEST SETUP

(A) Radiated Emission Test-Up Frequency Below 30MHz

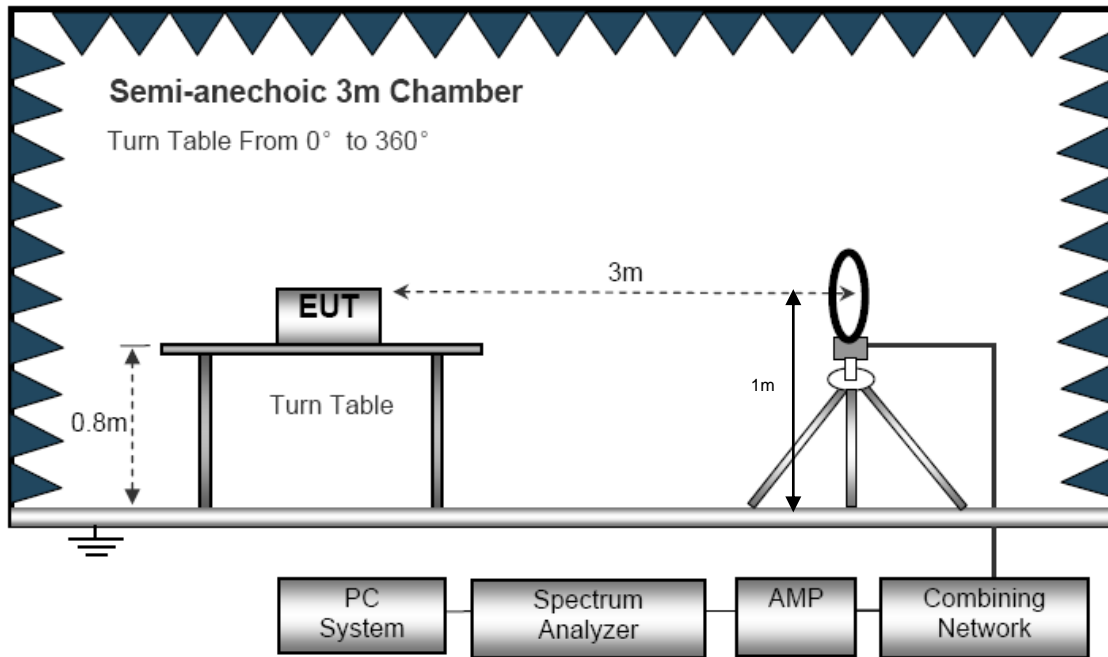

(B) Radiated Emission Test-Up Frequency 30MHz~1GHz

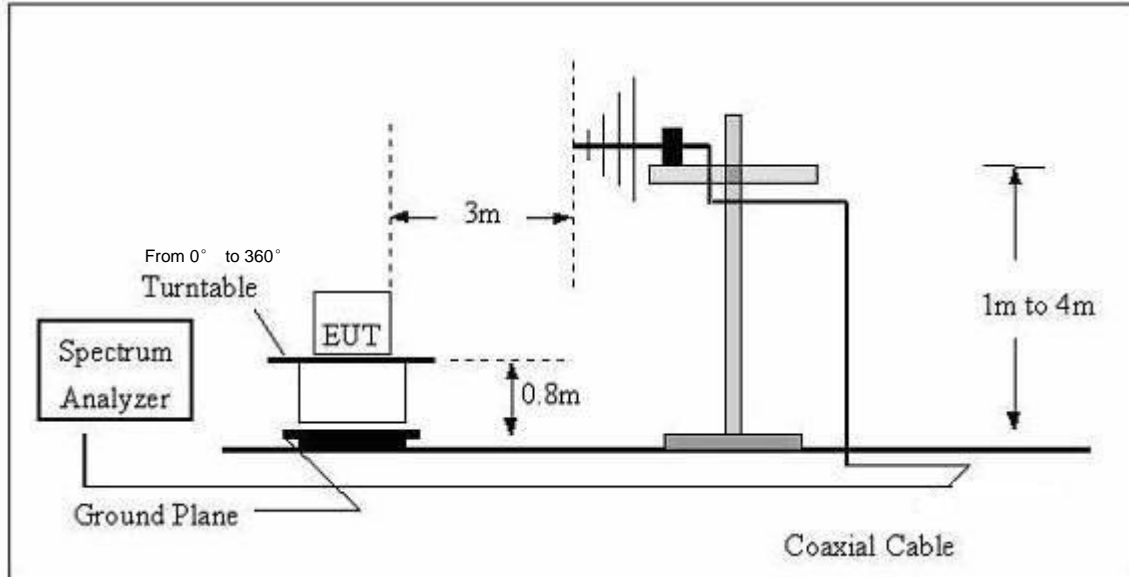

**4.2.5 TEST RESULTS (BELOW 30MHz)**

EUT :	rugged tablet	Model Name. :	AM171-RD86
Temperature :	20 °C	Relative Humidity :	54%
Pressure :	1010 hPa	Test Voltage :	DC 3.7V
Test Mode :	TX-13.56MHz		

**Measurement Plot (Polarity: X):**

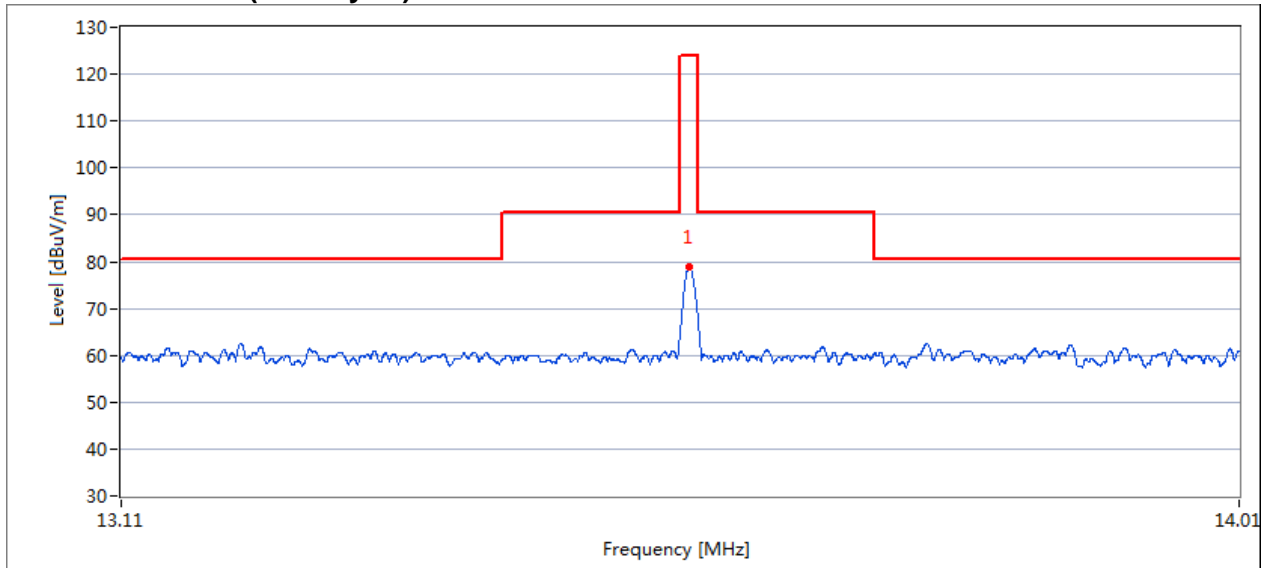

**Measurement Result:**

Frequency MHz	Pre-scan Level MaxPeak dBuV/m	Final Test Level MaxPeak dBuV/m	Limit MaxPeak dBuV/m	Margin dB
13.559	78.8	78.0	124.0	46.0

**Measurement Plot (Polarity: Y):**

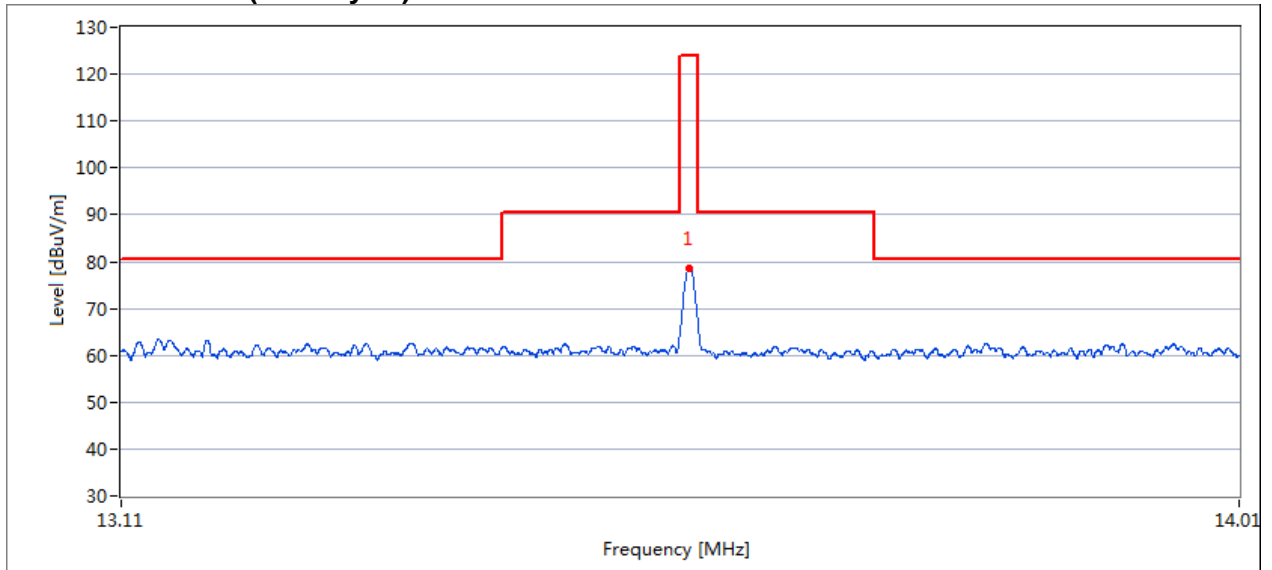

**Measurement Result:**

Frequency MHz	Pre-scan Level MaxPeak dBuV/m	Final Test Level MaxPeak dBuV/m	Limit MaxPeak dBuV/m	Margin dB
13.560	78.5	77.3	124.0	46.7

**Measurement Plot (Polarity: Z):**

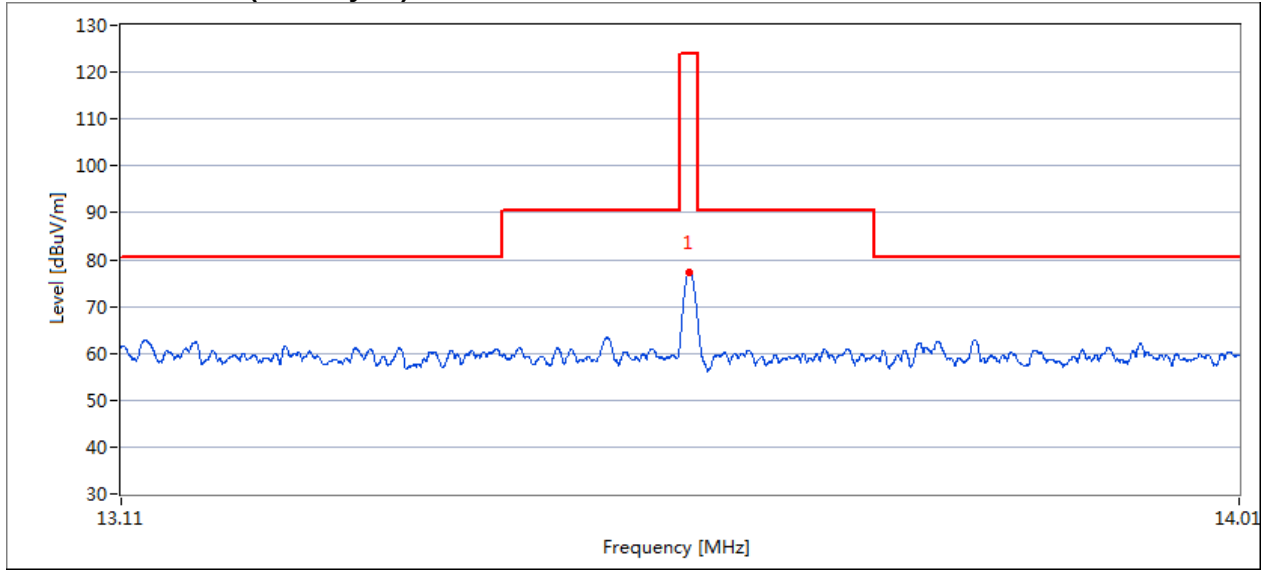

**Measurement Result:**

Frequency MHz	Pre-scan Level MaxPeak dBuV/m	Final Test Level MaxPeak dBuV/m	Limit MaxPeak dBuV/m	Margin dB
13.560	77.3	76.8	124.0	47.2

Spurious emissions at 9KHz~13.110MHz & 14.010MHz~30MHz

Frequency (MHz)	Ant.Pol. dB $\mu$ V @3m	Emission Level (dB $\mu$ V/m)	Limits dB $\mu$ V/m @3m	Margin (dB)	Detector
		@3m			
0.296	X	64.92	103.798	-38.88	Avg(fundamental frequency)
1.618	X	39.54	66.248	-26.71	QP
7.025	X	40.57	69.542	-28.97	QP
15.269	X	40.26	69.542	-29.28	QP
27.269	X	42.32	69.542	-27.22	QP

Note:

Below 30MHz, Pre-test the X, Y, Z axis to find X axis is worst case, so only record X axis test data.

X: Field strength which this device generates since the position of the charging coil and loop antenna differ by 0 degrees.

Y: Field strength which this device generates since the position of the charging coil and loop antenna differ by 90 degrees.

Z: Field strength which this device generates since the position of the charging coil and loop antenna differ by 180 degrees

**4.2.6 TEST RESULTS (BETWEEN 30 – 1000 MHZ)**

EUT :	rugged tablet	Model Name :	AM171-RD86
Temperature :	24 °C	Relative Humidity :	53%
Pressure :	1010 hPa	Test Voltage :	DC 3.7V
Test Mode :	TX	Polarization :	Horizontal

Freq. (MHz)	Reading (dBµV/m)	Factor (dB)	Measurement (dBµV/m)	Limit (dBµV/m)	Over (dB)	Detector
238.3102	15.87	18.10	33.97	46.00	-12.03	QP
296.1836	16.81	20.35	37.16	46.00	-8.84	QP
360.4476	13.59	22.64	36.23	46.00	-9.77	QP
408.9460	15.40	23.82	39.22	46.00	-6.78	QP
444.8514	16.01	24.94	40.95	46.00	-5.05	QP
593.0497	11.27	28.15	39.42	46.00	-6.58	QP

Remark:  
Factor = Antenna Factor + Cable Loss.

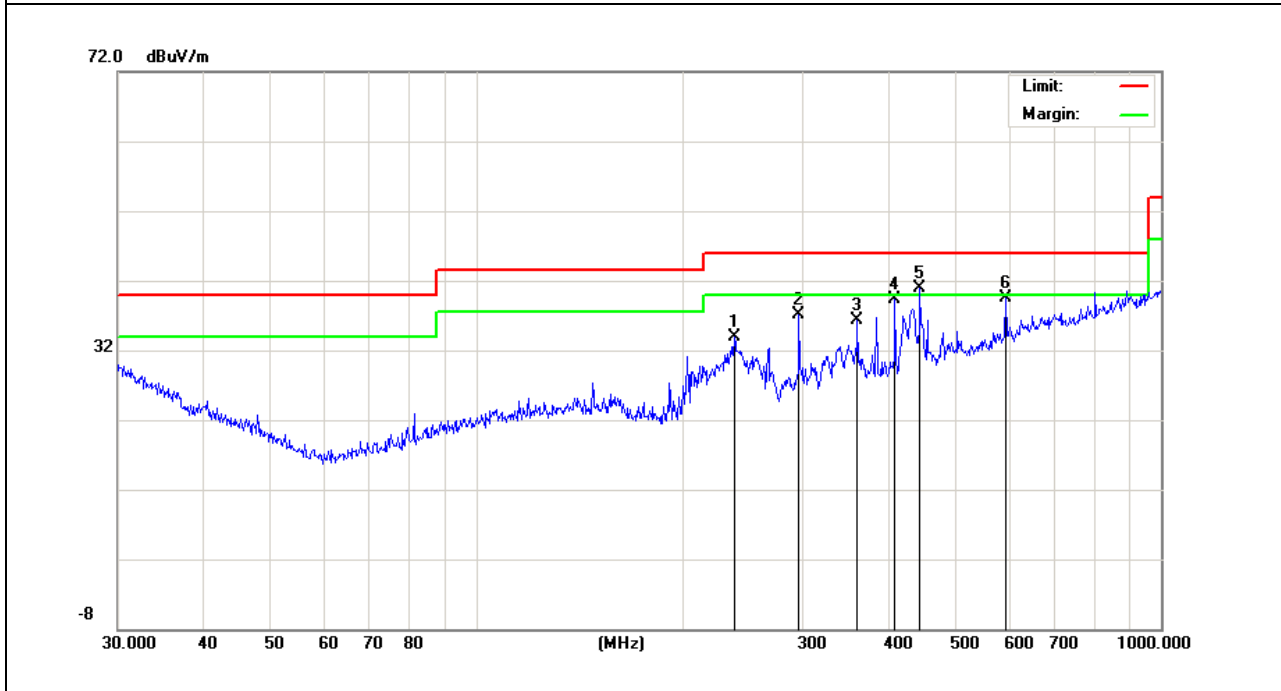

EUT :	rugged tablet	Model Name :	AM171-RD86
Temperature :	24 °C	Relative Humidity :	53%
Pressure :	1010 hPa	Test Voltage :	DC 3.7V
Test Mode :	TX	Polarization :	Vertical

Freq. (MHz)	Reading (dBμV/m)	Factor (dB)	Measurement (dBμV/m)	Limit (dBμV/m)	Over (dB)	Detector
81.2117	13.00	14.04	27.04	40.00	-12.96	QP
147.9214	11.13	18.28	29.41	43.50	-14.09	QP
394.8545	9.52	23.57	33.09	46.00	-12.91	QP
510.0436	10.16	26.60	36.76	46.00	-9.24	QP
706.6997	8.46	29.60	38.06	46.00	-7.94	QP
801.7862	9.15	30.92	40.07	46.00	-5.93	QP

Remark:  
Factor = Antenna Factor + Cable Loss.

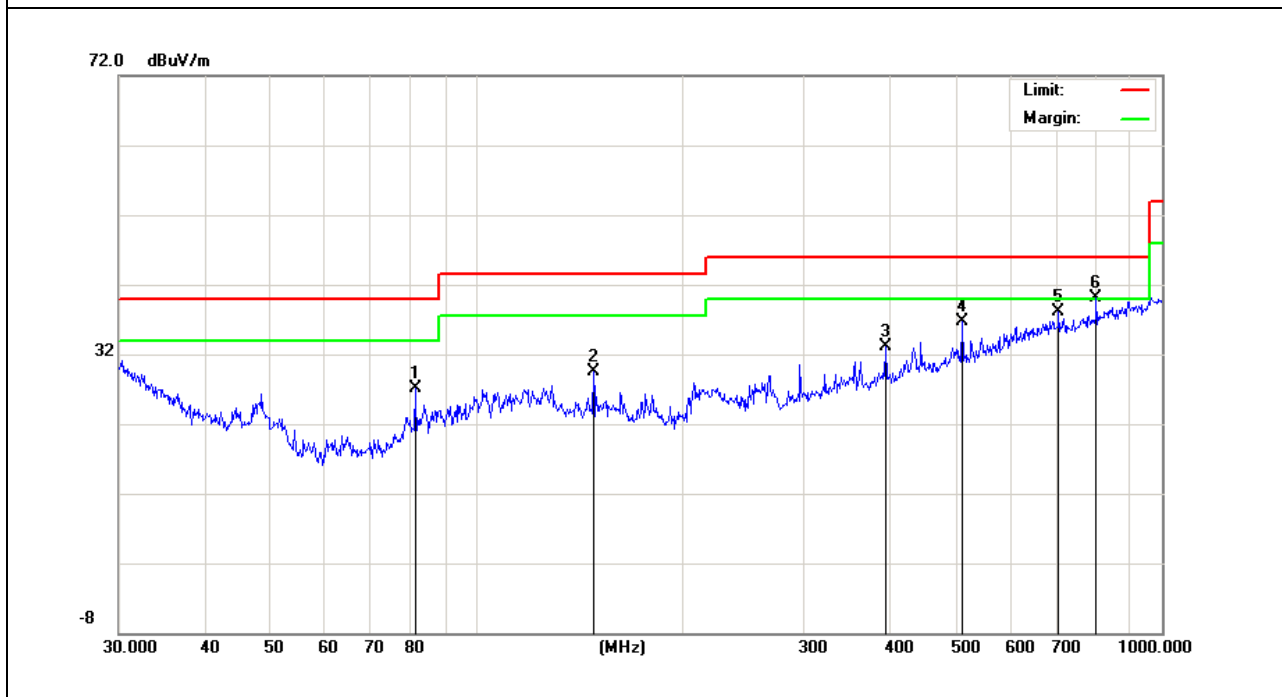

## 5. BANDWIDTH TEST

### 5.1 TEST PROCEDURE

1. The transmitter output (antenna port) was connected to the spectrum analyzer in peak mode.
2. 20dB Bandwidth the resolution bandwidth of 1 kHz and the video bandwidth of 1 kHz were used.
3. Measured the spectrum width with power higher than 20dB below carrier.

### 5.2 DEVIATION FROM STANDARD

15.215

(c) Intentional radiators operating under the alternative provisions to the general emission limits, as contained in §§15.217 through 15.257 and in subpart E of this part, must be designed to ensure that the 20 dB bandwidth of the emission, or whatever bandwidth may otherwise be specified in the specific rule section under which the equipment operates, is contained within the frequency band designated in the rule section under which the equipment is operated

FCC Part15.225

Operation within the band 13.110 - 14.010MHz

### 5.3 TEST SETUP

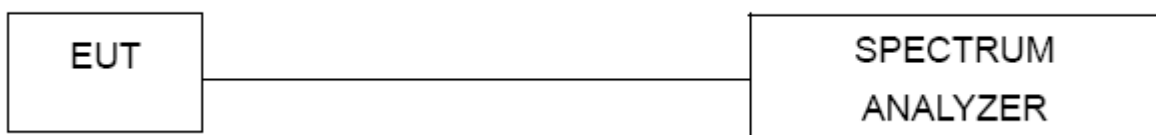



5.4 TEST RESULTS

EUT :	rugged tablet	Model Name :	AM171-RD86
Temperature :	26 °C	Relative Humidity :	54%
Pressure :	1020 hPa	Test Power :	DC 3.7V
Test Mode :	TX		

Test Channel	Frequency (MHz)	20 dBc Bandwidth (kHz)
CH01	13.56	2.48

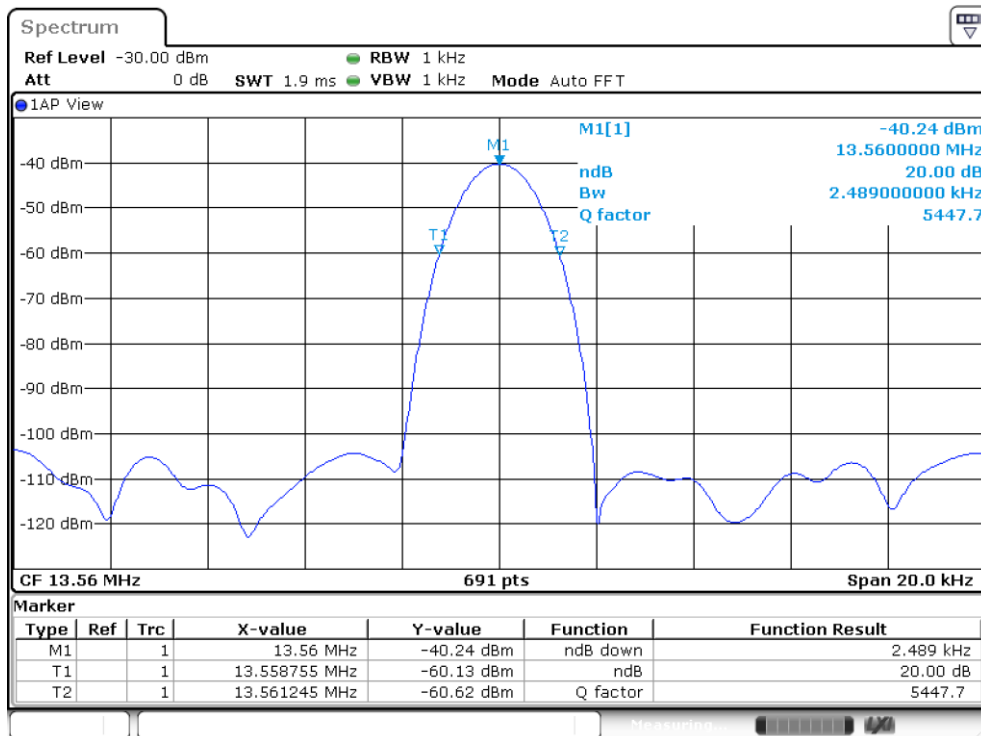

## 6. FREQUENCY TOLERANCE

### 6.1 Requirement:

Test Requirement: FCC Part15.225

Requirement:

Test Method: ANSI C63.4:2014

Requirement: The frequency tolerance of the carrier signal shall be maintained within +/- 0.01% of the operating frequency over a temperature variation of -20 degrees to +50 degrees C at normal supply voltage, and for a variation in the primary supply voltage from 85% to 115% of the rated supply voltage at a temperature of 20 degrees C. For battery operated equipment, the equipment tests shall be performed using a new battery.

### 6.2 Test Procedure

- 1.The EUT was placed on a turn table which is 0.8m above ground plane.
- 2.Set EUT as normal operation
- 3.Set SPA Center Frequency = fundamental frequency, RBW, VBW= 10kHz, Span =100kHz.
- 4.Set SPA Max hold. Mark peak.

**Test Result**

Power Supply	Temperature (°C)	Measured Frequency (MHz)	Frequency Error (MHz)	Result (ppm)	Part 15.225 Limit
DC 3.3V	-20	13.56014	0.00014	10.3244838	+/- 0.01%(100ppm)
	20	13.56013	0.00013	9.5870206	+/- 0.01%(100ppm)
	50	13.56067	0.00067	49.4100295	+/- 0.01%(100ppm)
DC 3.7V	-20	13.56065	0.00065	47.9351032	+/- 0.01%(100ppm)
	20	13.56063	0.00063	46.4601770	+/- 0.01%(100ppm)
	50	13.56054	0.00054	39.8230088	+/- 0.01%(100ppm)
DC 4.2V	-20	13.56057	0.00057	42.0353982	+/- 0.01%(100ppm)
	20	13.56049	0.00049	36.1356932	+/- 0.01%(100ppm)
	50	13.56047	0.00047	34.6607670	+/- 0.01%(100ppm)

END REPORT