

HiStone

User Manual

(HK568 Series All-in-One POS device)

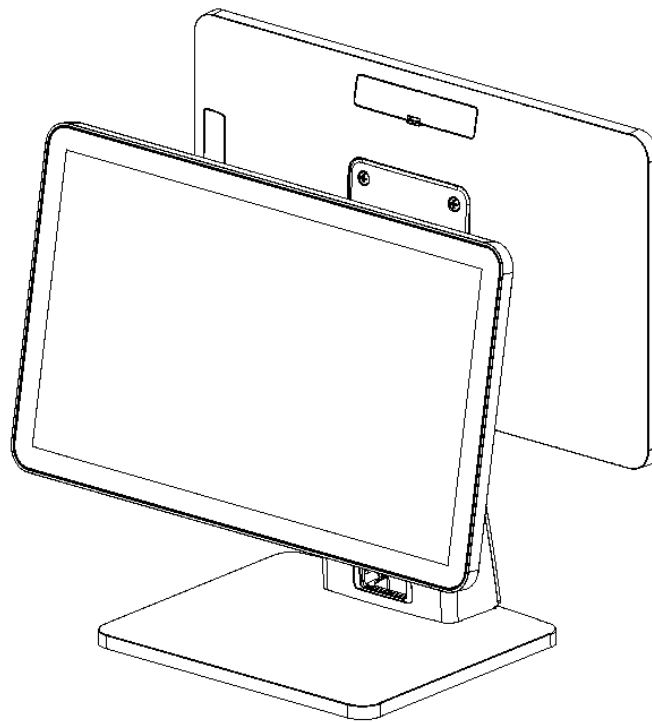

QingDao Histone Intelligent Commercial System Co.,Ltd.

General User Notices

Thank you very much for choosing our cash register. Before installing and using this product, please read this manual carefully so as to have a deep understanding of its performance. Please keep this manual well for future reference if you encounter problems in use.

In order to improve the products, the company will adopt new technologies, new components and new software as much as possible. Therefore, the company has the right to make changes without notice. The features, functions and operations described in this manual may not be completely consistent with the performance of the machines sold by our company in various places. In some cases, the pictures are only prototypes of the equipment. Before using this manual, you should ask our company or dealers applicable information.

This equipment must be installed by after-sales service personnel or dealers. The company is not responsible for any consequences caused by unauthorized changes to the equipment or replacement of connecting equipment and cables in accordance with regulations.



Warning:

- Static may cause damage to the POS.
- Incorrectly replacing a battery can result in an explosion. Make sure to only replace the battery with the same or equivalent type as recommended by the manufacturer (Histone). Discard used batteries according to the manufacturer's instructions.
- Do not remove the peripheral device before you turn off the system. Turn on the system after you turn on peripheral devices and turn off the peripheral devices after you turn off the system.

The manufacturer has the right to modify the content of the manual without prior notice!

Product standard number: Q/HSK J03001

Product Standard Name: Commercial Cash Register

- **Application range**

Our POS devices adopts an open system, flexible component structure and standard peripheral interface. The product is suitable for network connection or stand-alone use in supermarkets, department stores, convenience stores, hotels and other commercial enterprises; all main components adopt standard Products, so the product quality is reliable, it is easy to upgrade the system, the maintenance of components is convenient and simple, and the reasonable cost performance makes it more competitive compared with similar products.

Product basic configuration :

category	part	HK568 (J6412)
host	processor	J6412
	Memory	Standard 4G DDR4
	storage	Standard 128G SSD
	operator display	15.6" FHD LCD with a resolution of 1920*1080
	ethernet	1000M Ethernet
	customer display(optional)	10.1" FHD LCD with a resolution of 1280*800
		15.6" FHD LCD with a resolution of 1920*1080
	printer (optional)	58mm thermal printer
		80mm thermal printer
	cash drawer (optional)	steel cash box
Magnetic card reader (optional)	Magnetic Stripe Card Reader	
	Contactless Card Reader	
barcode scanner (optional)	Support (1D/2D scanning)	

- **Interfaces**

HK568-J6412 Mainboard

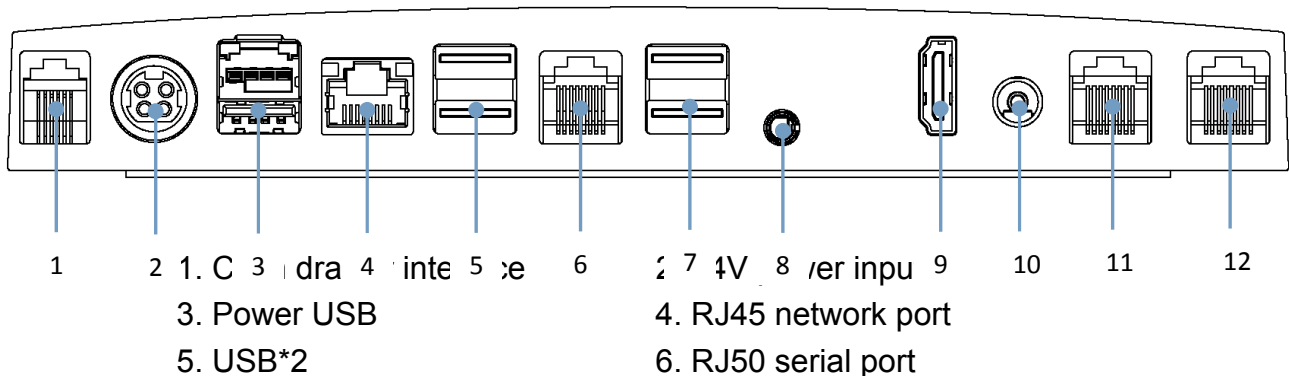

- 7. USB*2
- 9. HDMI
- 11. RJ50 serial port

- 8. Audio output
- 10. 12V output
- 12. RJ50 serial port

● **Environmental Absolute Grade**

Category		Description
Environment	Power Input	AC 100~240V 50-60Hz (grounding)
	Working Temperature	0°C - 40°C
	Working Humidity	35% ~ 80%
	Storage Temperature	-20°C - 55°C
	Storage Humidity	20% ~ 93%

● **System Dimensions**

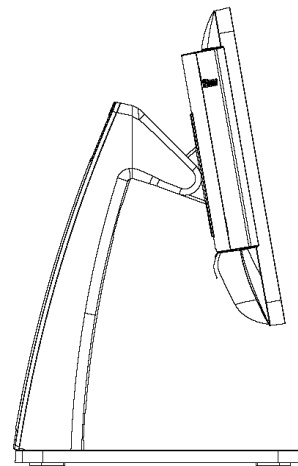
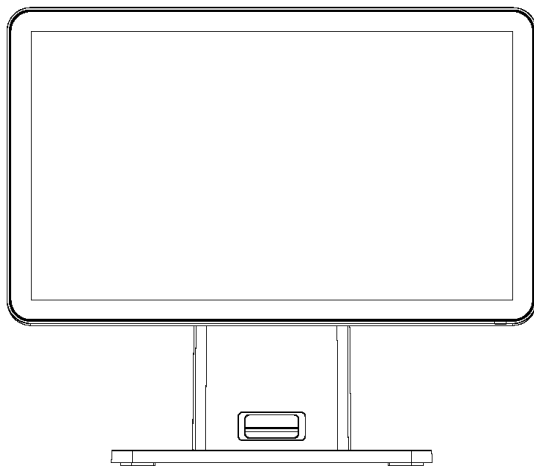

Single screen, length×width×height: 380mm*198mm*327mm; main screen flip angle 0-45°

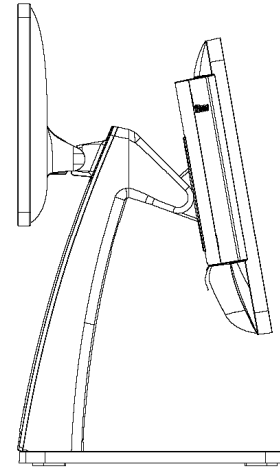
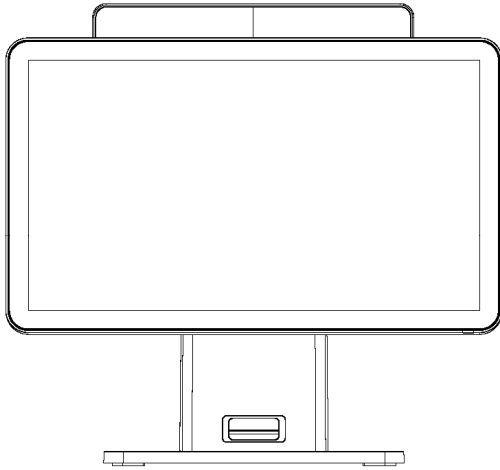

15.6-inch main screen + 10.1-inch secondary screen, length×width×height: 380mm*205mm*353mm; the flip angle of the main screen is 0-45°, and the flip angle of the secondary screen is 0-30°

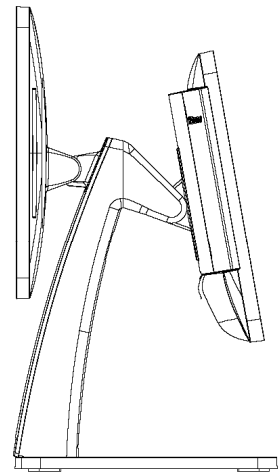
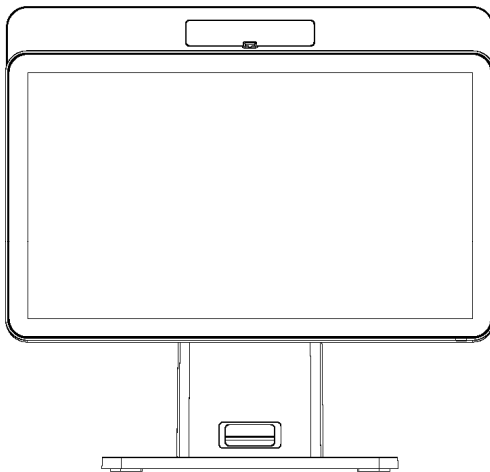

15.6-inch main screen + 15.6-inch secondary screen, length × width × height: 380mm*205mm*362mm; main screen flip angle 0-45°, secondary screen flip angle 0-30°

● **Unpacking and Inspection**

- 1) Before unpacking, inspect the outer packing box is in good condition and check if there is any visible damage. Contact your dealer if you notice that the package is damaged as soon as possible.
- 2) When taking out the machine from the carton handle it carefully and avoid bumping.
- 3) Check the packing accessories and ensure the items are included: a power adapter, a power cable and connecting cables.
- 4) Check the machine and inspect it for obvious scratches or appearance damages.
- 5) The machine must be installed by a service technician or by an authorized dealer.

- **Instruction for Usage**

- 1) **Switching Instruction**

- Start-up: When the adapter is connected, press the Power button on the right back side of the bottom of the machine, see the button indicator light on, then start-up can be achieved.

- 2) **Instructions for using magnetic stripe cards**

- When swiping the card, the machine should be placed on a hard horizontal plane.
 - Please scratch the magnetic strip of the magnetic strip card inward from the swipe slot.
 - The card swiping process should be smooth and uniform.

- 3) **Instructions for using RFID contactless cards**

- The RFID contactless card reader module is located behind the right side of the Host. (with a contactless payment sign)
 - When the induction card is not received, please place the card above the induction area.

- **Instructions for matching the printer adapter**

When the system is configured with printers of different specifications, adapters with corresponding power need to be used together. See the table below for matching instructions :

Printer Specifications	adapter power rate
no printer	60W
58mm thermal printer	60W
80mm thermal printer	120W

- **Safety Notes**

- 1) The cash register requires that the external power supply should be grounded well. The ground resistance value should be less than 0.1Ω and the machine must connect to a grounded international three 3-pin power socket. If the power supply is ungrounded or improperly grounded may cause leakage current. It will be hazardous to

the user and also affect the normal operation of the cash register.

- 2) During the operation, must use a three 3-pin power socket and a UPS that meet CCC certification national standards. It needs to be grounded well and the supply voltage shall be stable. Make sure the voltage of the outlet provides shall be in line with the voltage marked on the label of the unit.
 - 3) The unit shall be used under dry, ventilated & clean environment away from sunlight. Avoid making the air vent of the host machine blocked or covered. Ensure the air vent has an exhaust outlet with a certain opening gap.
 - 4) The product is a Level A one, it may cause radio interference in living environment. In such case, users may need to take practical & feasible measures against the interference.
 - 5) Be sure neither to lengthen cable nor to replace parts at your will, if you have any demand, please contact with the reseller.
 - 6) Be sure not to unplug or plug in any live part or external device when they are in energized state, and the connecting cables of the POS between parts shall be connected securely.
 - 7) The RJ11 interface on the rear of the main unit is connected to the cash drawer, it is not a communication port, and users cannot use this port for dial-up Internet access.
 - 8) When inserting USB flash or disk, you shall kill virus to prevent the host machine from virus. Android doesn't support NTFS file system. If the USB flash drive you insert is NTFS file system, it won't be supported.
 - 9) Do not switch on or off the host frequently, because it is easy to result in damage on the machine.
 - 10) Be sure not to sprinkle any liquid or fall any object into the unit.
 - 11) Be sure not to keep heavy, strenuous movement, shake & heavy strike away from the POS.
 - 12) If any liquid sprinkles or any sundry falls into the unit, please shut it down immediately & switch off power supply, take batteries down, dry the liquid or remove the sundry. If you take the batteries down, you shall reset CMOS.
 - 13) In case of safety fault, such as peculiar smell, abnormal sound, leakage, and other faults, you must switch off the power supply at once and then contact with reseller. When the POS is not in use, you shall switch off power supply. Do not directly turn off the main power supply, you should exit the application program, turn off the machine, then turn off the main power supply, and put on a dust cover.

- **Labeling description of product components**

- This product meets the environmental requirements of the "Administrative Measures for Restricting the Use of Hazardous Substances in Electrical and Electronic Products".
- Within the environmental protection use period, there will be no leakage and precipitation of harmful substances during the use of consumers, which will affect the health of consumers, so you can use it with confidence.

- **Disposal and recycling tips**

When this product is not needed or its life is over, please abide by the relevant national laws and regulations on the recycling of waste electrical and electronic products, and hand it over to a local manufacturer with nationally recognized recycling qualifications for recycling. Recyclers need to properly dispose of components containing hazardous substances, and must not dispose of them arbitrarily.

- **Environmental protection use period**

The environmental protection use period of this product is 10 years.

Part Name	Toxic and hazardous substances or elements									
	铅 (Pb)	汞 (Hg)	镉 (Cd)	六价铬 (Cr6+)	多溴 联苯 (PBB)	多溴二苯醚 (PBDE)	DIB P	BBP	DBP	DEHP
motherboard	○	○	○	○	○	○	○	○	○	○
Memory	○	○	○	○	○	○	○	○	○	○
hard disk	○	○	○	○	○	○	○	○	○	○
power supply	○	○	○	○	○	○	○	○	○	○
monitor	○	○	○	○	○	○	○	○	○	○

customer display	O	O	O	O	O	O	O	O	O	O
keyboard	O	O	O	O	O	O	O	O	O	O
printer	O	O	O	O	O	O	O	O	O	O
CPU fan	O	O	O	O	O	O	O	O	O	O
various cables	O	O	O	O	O	O	O	O	O	O
cash box	O	O	O	O	O	O	O	O	O	O
Chassis	O	O	O	O	O	O	O	O	O	O
Packaging	O	O	O	O	O	O	O	O	O	O

*The format of this standard is prepared according to the provisions of SJ/T11364.
 "O" indicates that the content of the toxic and hazardous substance in all homogeneous materials of the part is below the limit requirement specified in GB/T26572.
 "X" indicates that the content of the toxic and hazardous substance in at least one homogeneous material of the part exceeds the limit requirement specified in GB/T26572.

Note: DIBP-diisobutyl phthalate
BBP-butyl phthalate
DBP-dibutyl phthalate
DEHP-di(2-ethylhexyl)phthalate

● **Accessories Annexes**

No.	Item	Qty	Note
1	POS	1	
2	Adaptor	1	
3	Power Cable	1	

● **Others**

For the drivers of other peripheral devices, refer to the USB driver from the package.
 You can log in to Histone website or contact Histone via 24h customer service hotline.

Website : <http://hics.Histonetec.com>

24h customer service hotline : 4006-585-111

● **FCC Statement:**

This device complies with part 15 of the FCC Rules. Operation is subject to the following

two conditions: (1) This device may not cause harmful interference, and (2) this device must accept any interference received, including interference that may cause undesired operation.

This equipment has been tested and found to comply with the limits for ac Class B digital device, pursuant to part 15 of the FCC Rules. These limits are designed to provide reasonable protection against harmful interference in a residential installation. This equipment generates, uses and can radiate radio frequency energy and ,if not installed and used in accordance with the instructions, may cause harmful interference to radio communications. However ,there is no guarantee that interference will not occur in a particular installation. If this equipment does cause harmful interference to radio or television reception, which can be determined by turning the equipment off and on, the user is encouraged to try to correct the interference by one or more of the following measures:

- Reorient or relocate the receiving antenna.
- Increase the separation between the equipment and receiver.
- Connect the equipment into an outlet on a circuit different from that to which the receiver is connected
- Consult the dealer or an experienced radio/TV technician for help.

Caution: Any changes or modifications not expressly approved by the party responsible

for compliance could void the user's authority to operate the equipment.

This equipment complies with FCC radiation exposure limits set forth for an uncontrolled environment. This transmitter must not be co-located or operating in conjunction with any other antenna or transmitter.

This equipment should be installed and operated with minimum distance 20cm between the radiator & your body

24h
Serving

24h customer service hotline

4006-585-111

QC :

HiStone

QINGDAO HISTONE INTELLIGENT COMMERCIAL SYSTEM CO.,LTD.

HQ Office: Qingdao, China

Phone: 0086-532-55751230

Fax: 0086-532-55751234

Website: <http://hics.Histonetec.com/>