



Radio Test Report

Report No.: STS2508081W04

Issued for

Hot Pepper Mobile Inc.

350 10th Ave 1000 Ste San Diego California Unite States
92101-8705

Product Name: Smart Phone

Brand Name: Hot pepper

Model Name: HPPH88L

Series Model(s): N/A

FCC ID: 2A33N-L67B

Test Standards: FCC Part15.407

The test results presented in this report relate only to the object tested. This report shall not be reproduced, except in full, without the written approval of the Shenzhen STS Test Services Co., Ltd.



TEST REPORT

Applicant's Name: Hot Pepper Mobile Inc.
Address: 350 10th Ave 1000 Ste San Diego California Unite States
92101-8705
Manufacturer's Name.....: Hot Pepper Mobile Inc.
Address: 350 10th Ave 1000 Ste San Diego California Unite States
92101-8705

Product Description

Product Name.....: Smart Phone
Brand Name.....: Hot pepper
Model Name: HPPH88L
Series Model(s): N/A

Test Standards: FCC Part15.407

Test Procedure..... ANSI C63.10-2020

This device described above has been tested by STS, the test results show that the equipment under test (EUT) is in compliance with the FCC requirements. And it is applicable only to the tested sample identified in the report.

The test results presented in this report relate only to the object tested. This report shall not be reproduced, except in full, without the written approval of the Shenzhen STS Test Services Co., Ltd.

Date of Test

Date of receipt of test item.....: 13 Aug. 2025
Date (s) of performance of tests.....: 13 Aug. 2025 ~ 22 Aug. 2025
Date of Issue.....: 22 Aug. 2025
Test Result.....: Pass

Testing Engineer : [Signature]
(Aaron Bu)

Technical Manager : [Signature]
(Skylar Li)

Authorized Signatory : [Signature]
(Bovey Yang)





Table of Contents	Page
1 . SUMMARY OF TEST RESULTS	6
1.1 TEST FACTORY	7
1.2 MEASUREMENT UNCERTAINTY	7
2. GENERAL INFORMATION	8
2.1 GENERAL DESCRIPTION OF THE EUT	8
2.2 DESCRIPTION OF TEST MODES	11
2.3 TEST SOFTWARE AND POWER LEVEL	12
2.4 BLOCK DIAGRAM SHOWING THE CONFIGURATION OF SYSTEM TESTED	13
2.5 DESCRIPTION OF NECESSARY ACCESSORIES AND SUPPORT UNITS	13
2.6 EQUIPMENTS LIST	14
3. EMC EMISSION TEST	15
3.1 CONDUCTED EMISSION MEASUREMENT	15
3.2 RADIATED EMISSION AND MEASUREMENT	19
4. POWER SPECTRAL DENSITY TEST	52
4.1 LIMIT	52
4.2 TEST PROCEDURE	52
4.3 DEVIATION FROM STANDARD	53
4.4 TEST SETUP	53
4.5 EUT OPERATION CONDITIONS	53
4.6 TEST RESULTS	53
5. BANDWIDTH MEASUREMENT	54
5.1 EMISSION BANDWIDTH (EBW) 26 BANDWID PROCEDURES / LIMIT	54
5.2 OCCUPIED BANDWIDTH (99%) TEST APPLIED PROCEDURES / LIMIT	55
5.3 MINIMUM EMISSION BANDWIDTH(6 DB) PROCEDURES / LIMIT	56
6. MAXIMUM OUTPUT POWER	57
6.1 LIMIT	57
6.2 TEST PROCEDURE	57
6.3 DEVIATION FROM STANDARD	57
6.4 TEST SETUP	57
6.5 EUT OPERATION CONDITIONS	57
6.6 TEST RESULTS	57
7. AUTOMATICALLY DISCONTINUE TRANSMISSION	58
7.1 LIMIT OF AUTOMATICALLY DISCONTINUE TRANSMISSION	58
7.2 TEST RESULT OF AUTOMATICALLY DISCONTINUE TRANSMISSION	58
8. ANTENNA REQUIREMENT	59



Table of Contents	Page
8.1 STANDARD REQUIREMENT	59
8.2 EUT ANTENNA	59
APPENDIX - PHOTOS OF TEST SETUP	60



Revision History

Rev.	Issue Date	Report No.	Effect Page	Contents
00	22 Aug. 2025	STS2508081W04	ALL	Initial Issue



1. SUMMARY OF TEST RESULTS

Test procedures according to the technical standards:

§ 15.407, KDB 789033 D02 General U-NII Test Procedures New Rules v02r01

FCC Part 15.407		
FCC standard	Test Item	Results
15.207	AC Conducted Emission	PASS
15.407 (a) /15.407 (e)	26dB/6dB &99% Bandwidth	PASS
15.407(a)	Maximum Conducted Output Power	PASS
15.407(b)/15.209	Radiated Emission And (bandedge Emissions) Measurement	PASS
15.407(a)	Power Spectral Density	PASS
15.407 (c)	Automatically Discontinue Transmission	PASS
15.203/15.204	Antenna Requirement	PASS

Note:

- (1) 'N/A' denotes test is not applicable in this Test Report.
- (2) All tests are according to ANSI C63.10-2020.



1.1 TEST FACTORY

SHENZHEN STS TEST SERVICES CO., LTD

Add.: 101, Building B, Zhuoke Science Park, No.190 Chongqing Road, ZhanChengShequ, Fuhai Sub-District, Bao'an District, Shenzhen, Guang Dong, China

FCC test Firm Registration Number: 625569

IC test Firm Registration Number: 12108A

A2LA Certificate No.: 4338.01

1.2 MEASUREMENT UNCERTAINTY

The reported uncertainty of measurement $y \pm U$, where expanded uncertainty U is based on a standard uncertainty multiplied by a coverage factor of $k=2$, providing a level of confidence of approximately **95** %.

No.	Item	Uncertainty
1	RF output power, conducted	$\pm 0.755\text{dB}$
2	Unwanted Emissions, conducted	$\pm 2.874\text{dB}$
3	All emissions, radiated 9K-30MHz	$\pm 3.80\text{dB}$
4	All emissions, radiated 30M-1GHz	$\pm 4.18\text{dB}$
5	All emissions, radiated 1G-6GHz	$\pm 4.90\text{dB}$
6	All emissions, radiated >6G	$\pm 5.24\text{dB}$
7	Conducted Emission (9KHz-150KHz)	$\pm 2.19\text{dB}$
8	Conducted Emission (150KHz-30MHz)	$\pm 2.53\text{dB}$
9	Occupied Channel Bandwidth	$\pm 3.5\%$
10	Power Spectral Density, conducted	$\pm 1.245\text{dB}$
11	Duty Cycle	$\pm 3.2\%$

2. GENERAL INFORMATION

2.1 GENERAL DESCRIPTION OF THE EUT

Product Name	Smart Phone	
Brand Name	Hot pepper	
Model Name	HPPH88L	
Series Model(s)	N/A	
Model Difference	N/A	
Product Description	The EUT is Smart Phone	
	Operation Frequency:	IEEE 802.11a/ n(HT20): 5.180GHz-5.240GHz IEEE 802.11n(HT40): 5.190GHz-5.230GHz IEEE 802.11a/ n(HT20):5.260GHz-5.320GHz IEEE 802.11 n(HT40): 5.270GHz-5.310GHz IEEE 802.11a/ n(HT20):5.500Gz-5.700GHz IEEE 802.11 n(HT40):5.510GHz-5.670GHz IEEE 802.11a/ n(HT20):5.745GHz-5.825GHz IEEE 802.11a/ n(HT40):5.755GHz-5.795GHz
	Modulation Type:	802.11a(OFDM): BPSK,QPSK,16-QAM,64-QAM 802.11n(OFDM): BPSK,QPSK,16-QAM,64-QAM
	Antenna Type:	PIFA
	Antenna Gain:	2.3dBi
	Max.Output Power(Conducted):	13.39 dBm
	More details of EUT technical specification, please refer to the User Manual.	
Test Channel	Please refer to the Note 3.	
Power Rating	Input: DC 5V 1A	
Adapter	Model: M050100-S37USVU Brand: N/A Input: 100-240VAC-50/60Hz 0.5A Output: DC 5V 1A	
Battery	Model: HLP2409G Brand: N/A Rated Voltage: 3.7V Charge Limit Voltage: 4.2V Capacity: 3000mAh	
Hardware version number	P1	
Software version number	N/A	
Connecting I/O Port(s)	Please refer to the Note 1.	

Note

- For a more detailed features description, please refer to the manufacturer's specifications or the User Manual.
- The antenna details in this report are based on the manufacturer provided antenna specification documents and apply only to the tested sample identified herein.
Any discrepancies in the antenna information may affect the accuracy of the test results, and the customer assumes responsibility for any related issues.

3.

Operation Frequency of channel			
5.180GHz-5.240GHz		5.500GHz-5.720GHz	
Channel	Frequency	Channel	Frequency
36	5180	100	5500
38	5190	102	5510
40	5200	110	5550
46	5230	116	5580
48	5240	134	5670
		140	5700
5.260GHz-5.320GHz			
Channel	Frequency		
52	5260		
54	5270		
60	5300		
62	5310		
64	5320		
5.745GHz-5.825GHz			
Channel	Frequency		
149	5745		
151	5755		
157	5785		
159	5795		
165	5825		

Note:

In section 15.31(m), regards to the operating frequency range over 10 MHz, the Lowest frequency, the middle frequency, and the highest frequency of channel were selected to perform the test, and the selected channel see below:

Carrier Frequency Channel

5GHz:

For 802.11a/n(HT20)			
Channel	Freq.(MHz)	Channel	Freq.(MHz)
36	5180	52	5260
40	5200	60	5300
48	5240	64	5320

For 802.11a/n(HT20)			
Channel	Freq.(MHz)	Channel	Freq.(MHz)
100	5500	149	5745
116	5580	157	5785
140	5700	165	5825

For 802.11 n(HT40)			
Channel	Freq.(MHz)	Channel	Freq.(MHz)
38	5190	54	5270
46	5230	62	5310

For 802.11 n(HT40)			
Channel	Freq.(MHz)	Channel	Freq.(MHz)
102	5510	151	5755
110	5550	159	5795
134	5670		

2.2 DESCRIPTION OF TEST MODES

To investigate the maximum EMI emission characteristics generated from EUT, the test system was pre-scanning tested based on the consideration of following EUT operation mode or test configuration mode which possibly have effect on EMI emission level. Each of these EUT operation mode(s) or test configuration mode(s) mentioned above was evaluated respectively.

Worst Mode	Description	Data Rate
Mode 1	TX IEEE 802.11a HT20 CH36&CH40&CH48	6 Mbps
Mode 2	TX IEEE 802.11a HT20 CH52&CH60&CH64	6 Mbps
Mode 3	TX IEEE 802.11a HT20 CH100&CH116&CH140	6 Mbps
Mode 4	TX IEEE 802.11a HT20 CH149&CH157&CH165	6 Mbps
Mode 5	TX IEEE 802.11n HT20 CH36&CH40&CH48	MCS 0
Mode 6	TX IEEE 802.11n HT20 CH52&CH60&CH64	MCS 0
Mode 7	TX IEEE 802.11n HT20 CH100&CH116&CH140	MCS 0
Mode 8	TX IEEE 802.11n HT20 CH149&CH157&CH165	MCS 0
Mode 9	TX IEEE 802.11n HT40 CH38&CH46	MCS 0
Mode 10	TX IEEE 802.11n HT40 CH54 &CH62	MCS 0
Mode 11	TX IEEE 802.11n HT40 CH102&CH110&CH134	MCS 0
Mode 12	TX IEEE 802.11n HT40 CH151&CH159	MCS 0

- Note: (1) The measurements are performed at the highest, middle, lowest available channels.
 (2) The measurements are performed at all Bit Rate of Transmitter, the worst data was reported.
 (3) We have been tested for all available U.S. voltage and frequencies (For 120V, 50/60Hz and 240V, 50/60Hz) for which the device is capable of operation.

AC Conducted Emission

Test Case	
AC Conducted Emission	Mode 13: Keeping TX + WLAN Link

2.3 TEST SOFTWARE AND POWER LEVEL

During testing channel & power controlling software provided by the customer was used to control the operating channel as well as the output power level.

RF Function	Type	Mode Or Modulation type	ANT Gain(dBi)	Power Class	Software For Testing
WIFI(5G)	U-NII-1 (5150MHz-5250MHz)	802.11a	2.3	14	Engineering mode
		802.11n(HT20)		14	
		802.11n(HT40)		14	
RF Function	Type	Mode Or Modulation type	ANT Gain(dBi)	Power Class	Software For Testing
WIFI(5G)	U-NII-2A (5250MHz-5350MHz)	802.11a	2.3	14	Engineering mode
		802.11n(HT20)		14	
		802.11n(HT40)		14	
RF Function	Type	Mode Or Modulation type	ANT Gain(dBi)	Power Class	Software For Testing
WIFI(5G)	U-NII-2C (5470MHz-5725MHz)	802.11a	2.3	14	Engineering mode
		802.11n(HT20)		14	
		802.11n(HT40)		14	
RF Function	Type	Mode Or Modulation type	ANT Gain(dBi)	Power Class	Software For Testing
WIFI(5G)	U-NII-3 (5725MHz-5895MHz)	802.11a	2.3	14	Engineering mode
		802.11n(HT20)		14	
		802.11n(HT40)		14	

2.4 BLOCK DIAGRAM SHOWING THE CONFIGURATION OF SYSTEM TESTED

Radiated Spurious Emission Test



Conducted Emission Test

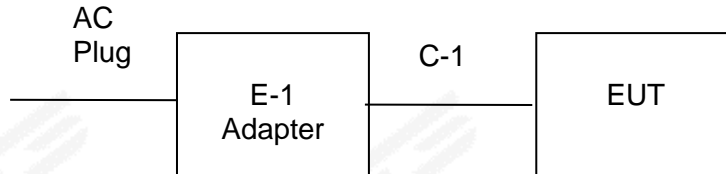

RF Conducted Test



2.5 DESCRIPTION OF NECESSARY ACCESSORIES AND SUPPORT UNITS

The EUT has been tested as an independent unit together with other necessary accessories or support units. The following support units or accessories were used to form a representative test configuration during the tests.

Item	Equipment	Mfr/Brand	Model/Type No.	Note
E-1	Adapter	N/A	M050100-S37USVU	N/A

Item	Equipment	Mfr/Brand	Length	Note
C-1	Shielded	NO	100cm	N/A

Note:

- (1) For detachable type I/O cable should be specified the length in cm in 『Length』 column.

2.6 EQUIPMENTS LIST

RF Radiation Test Equipment					
Kind of Equipment	Manufacturer	Type No.	Serial No.	Last Calibration	Calibrated Until
Temperature & Humidity	SW-108	SuWei	N/A	2025.02.24	2026.02.23
Pre-Amplifier(0.1M-3GHz)	EM	EM330	060665	2025.02.22	2026.02.21
Pre-Amplifier(1G-18GHz)	SKET	LNPA-01018G-45	SK2018080901	2024.09.23	2025.09.22
Pre-Amplifier(18G-40GHz)	SKET	LNPA_1840-50	SK2018101801	2025.02.22	2026.02.21
Active loop Antenna	ZHINAN	ZN30900C	16035	2025.02.25	2026.02.24
Bilog Antenna	TESEQ	CBL6111D	34678	2024.09.30	2025.09.29
Horn Antenna	SCHWARZBECK	BBHA 9120D	02014	2023.09.24	2025.09.23
Horn Antenna	A-INFOMW	LB-180400-KF	J211020657	2023.10.10	2025.10.09
Positioning Controller	MF	MF-7802	MF-780208587	N/A	N/A
Signal Analyzer	R&S	FSV 40-N	101823	2024.09.23	2025.09.22
Switch Control Box	N/A	N/A	N/A	N/A	N/A
Filter Box	BALUN Technology	SU319E	BL-SZ1530051	N/A	N/A
Antenna Mast	MF	MFA-440H	N/A	N/A	N/A
Turn Table	MF	SC100_1	60531	N/A	N/A
AC Power Source	APC	KDF-11010G	F214050035	N/A	N/A
DC power supply	HONGSHENGFE NG	DPS-305AF	17064939	2024.09.23	2025.09.22
Test SW	EZ-EMC	Ver.STSLAB-03A1 RE			
Conduction Test Equipment					
Kind of Equipment	Manufacturer	Type No.	Serial No.	Last calibration	Calibrated until
Test Receiver	R&S	ESCI	101427	2024.09.24	2025.09.23
Limtter	CYBERTEK	EM5010	N/A	2024.09.24	2025.09.23
LISN	R&S	ENV216	101242	2024.09.24	2025.09.23
LISN	EMCO	3810/2NM	23625	2024.09.24	2025.09.23
Temperature & Humidity	SW-108	SuWei	N/A	2025.02.24	2026.02.23
Test SW	EZ-EMC	Ver.STSLAB-03A1 CE			
RF Connected Test					
Kind of Equipment	Manufacturer	Type No.	Serial No.	Last calibration	Calibrated until
Signal Analyzer	Agilent	N9020A	MY51510623	2025.02.22	2026.02.21
Temperature & Humidity test chamber	Safety test	AG80L	171200018	2025.02.22	2026.02.21
Switch control box	MW	MW100-RFCB	N/A	N/A	N/A
Temperature & Humidity	SW-108	SuWei	N/A	2025.02.24	2026.02.23
Test SW	MW	MTS 8310_2.0.0.0			

3. EMC EMISSION TEST

3.1 CONDUCTED EMISSION MEASUREMENT

3.1.1 POWER LINE CONDUCTED EMISSION Limits (Frequency Range 150KHz-30MHz)

FREQUENCY (MHz)	Class B (dBuV)		Standard
	Quasi-peak	Average	
0.15 -0.5	66 - 56 *	56 - 46 *	CISPR
0.50 -5.0	56.00	46.00	CISPR
5.0 -30.0	60.00	50.00	CISPR

0.15 -0.5	66 - 56 *	56 - 46 *	FCC
0.50 -5.0	56.00	46.00	FCC
5.0 -30.0	60.00	50.00	FCC

Note:

- (1) The tighter limit applies at the band edges.
- (2) The limit of “ * ” marked band means the limitation decreases linearly with the logarithm of the frequency in the range.

The following table is the setting of the receiver

Receiver Parameters	Setting
Attenuation	10 dB
Start Frequency	0.15 MHz
Stop Frequency	30 MHz
IF Bandwidth	9 kHz

3.1.2 TEST PROCEDURE

- a. The EUT is 0.8 m from the horizontal ground plane and 0.4 m from the vertical ground plane with EUT being connected to the power mains through a line impedance stabilization network (LISN). All other support equipments are powered from additional LISN(s). The LISN provides 50 Ohm/ 50uH of coupling impedance for the measuring instrument.
- b. Interconnecting cables that hang closer than 40 cm to the ground plane shall be folded back and forth in the center forming a bundle 30 to 40 cm long.
- c. I/O cables that are not connected to a peripheral shall be bundled in the center. The end of the cable may be terminated, if required, using the correct terminating impedance. The overall length shall not exceed 1 m.
- d. LISN is at least 80 cm from the nearest part of EUT chassis.
- e. For the actual test configuration, please refer to the related Item –EUT Test Photos.

3.1.3 DEVIATION FROM TEST STANDARD

No deviation

3.1.4 TEST SETUP

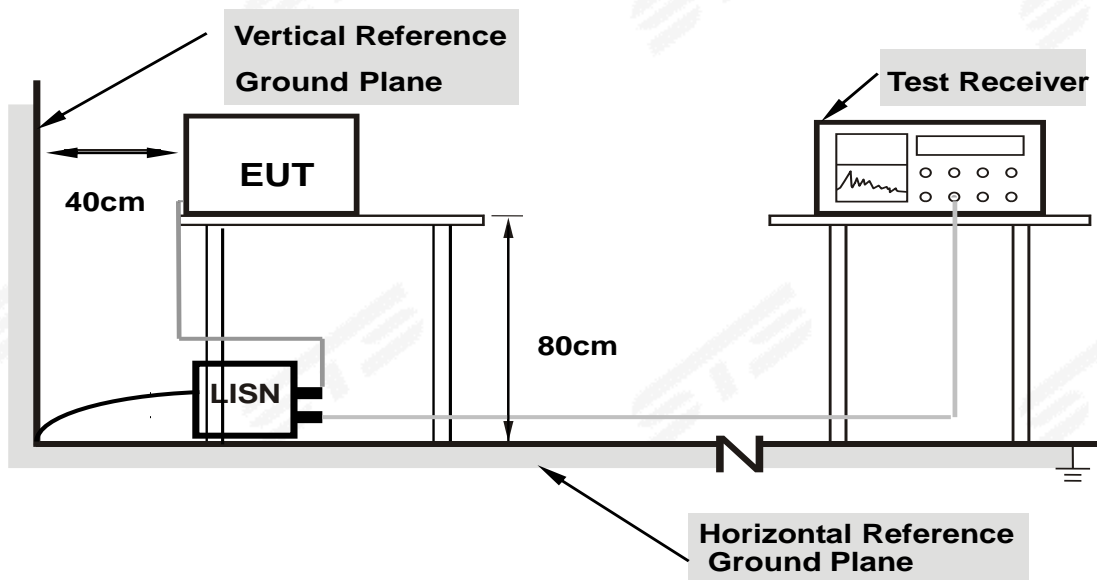

Note: 1. Support units were connected to second LISN.

- 2. Both of LISNs (AMN) are 80 cm from EUT and at least 80 cm from other units and other metal planes support units.**

3.1.5 EUT OPERATING CONDITIONS

The EUT was configured for testing in a typical fashion (as a customer would normally use it). The EUT has been programmed to continuously transmit during test. This operating condition was tested and used to collect the included data.

3.1.6 TEST RESULTS

Temperature:	25.1°C	Relative Humidity:	59%
Test Voltage:	AC 120V/60Hz	Phase:	L
Test Mode :	Mode 13		

No.	Frequency (MHz)	Reading (dBUV)	Correct Factor(dB)	Result (dBUV)	Limit (dBUV)	Margin (dB)	Remark
1	0.1620	39.17	19.88	59.05	65.36	-6.31	QP
2	0.1620	24.84	19.88	44.72	55.36	-10.64	AVG
3	0.4140	32.22	19.79	52.01	57.57	-5.56	QP
4	0.4140	15.41	19.79	35.20	47.57	-12.37	AVG
5	0.6780	31.66	19.80	51.46	56.00	-4.54	QP
6	0.6780	15.33	19.80	35.13	46.00	-10.87	AVG
7	0.8940	30.55	19.81	50.36	56.00	-5.64	QP
8	0.8940	17.20	19.81	37.01	46.00	-8.99	AVG
9	2.3700	29.96	19.81	49.77	56.00	-6.23	QP
10	2.3700	15.78	19.81	35.59	46.00	-10.41	AVG
11	4.3300	29.94	19.82	49.76	56.00	-6.24	QP
12	4.3300	14.10	19.82	33.92	46.00	-12.08	AVG

Remark:

1. All readings are Quasi-Peak and Average values
2. Margin = Result (Result =Reading + Factor)–Limit
3. Factor=LISN factor+Cable loss+Limiter (10dB)

100.0 dBUV

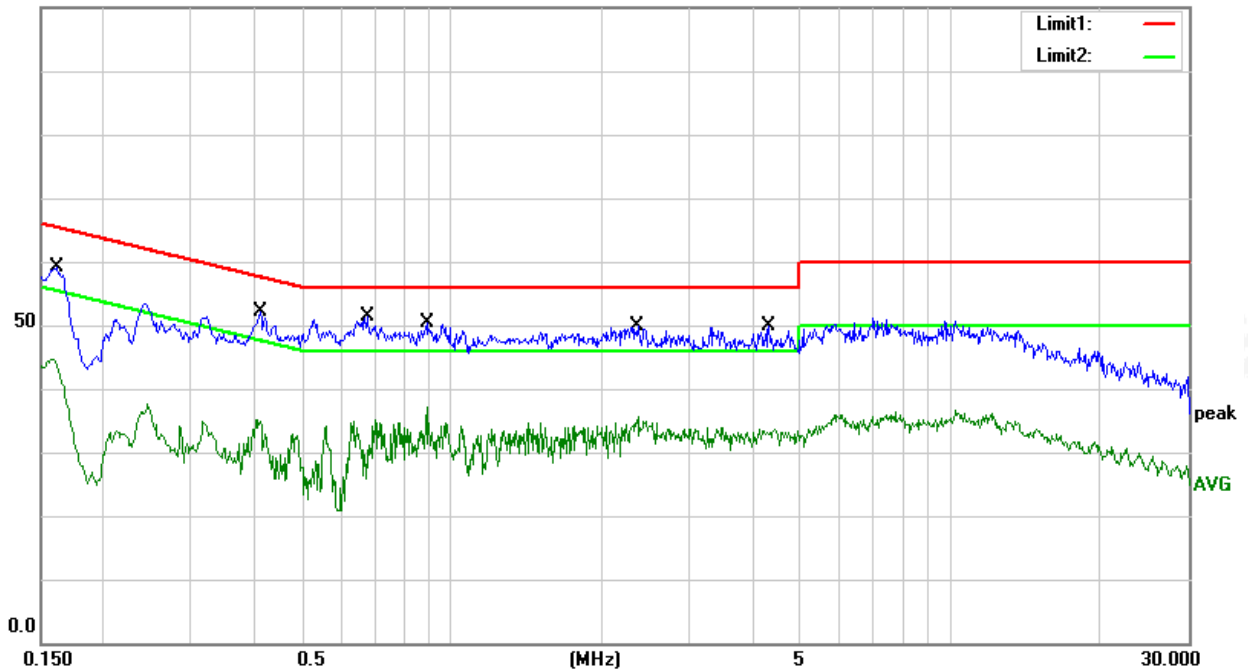

Temperature:	25.1°C	Relative Humidity:	59%
Test Voltage:	AC 120V/60Hz	Phase:	N
Test Mode :	Mode 13		

No.	Frequency (MHz)	Reading (dBuV)	Correct Factor(dB)	Result (dBuV)	Limit (dBuV)	Margin (dB)	Remark
1	0.1507	40.62	19.83	60.45	65.96	-5.51	QP
2	0.1507	27.28	19.83	47.11	55.96	-8.85	AVG
3	0.2420	33.12	19.80	52.92	62.03	-9.11	QP
4	0.2420	18.84	19.80	38.64	52.03	-13.39	AVG
5	0.5420	30.85	19.80	50.65	56.00	-5.35	QP
6	0.5420	16.02	19.80	35.82	46.00	-10.18	AVG
7	2.1140	29.99	19.78	49.77	56.00	-6.23	QP
8	2.1140	14.71	19.78	34.49	46.00	-11.51	AVG
9	4.1980	31.41	19.82	51.23	56.00	-4.77	QP
10	4.1980	15.99	19.82	35.81	46.00	-10.19	AVG
11	6.8180	33.47	19.80	53.27	60.00	-6.73	QP
12	6.8180	19.28	19.80	39.08	50.00	-10.92	AVG

Remark:

1. All readings are Quasi-Peak and Average values
2. Margin = Result (Result =Reading + Factor) –Limit
3. Factor=LISN factor+Cable loss+Limiter (10dB)

100.0 dBuV

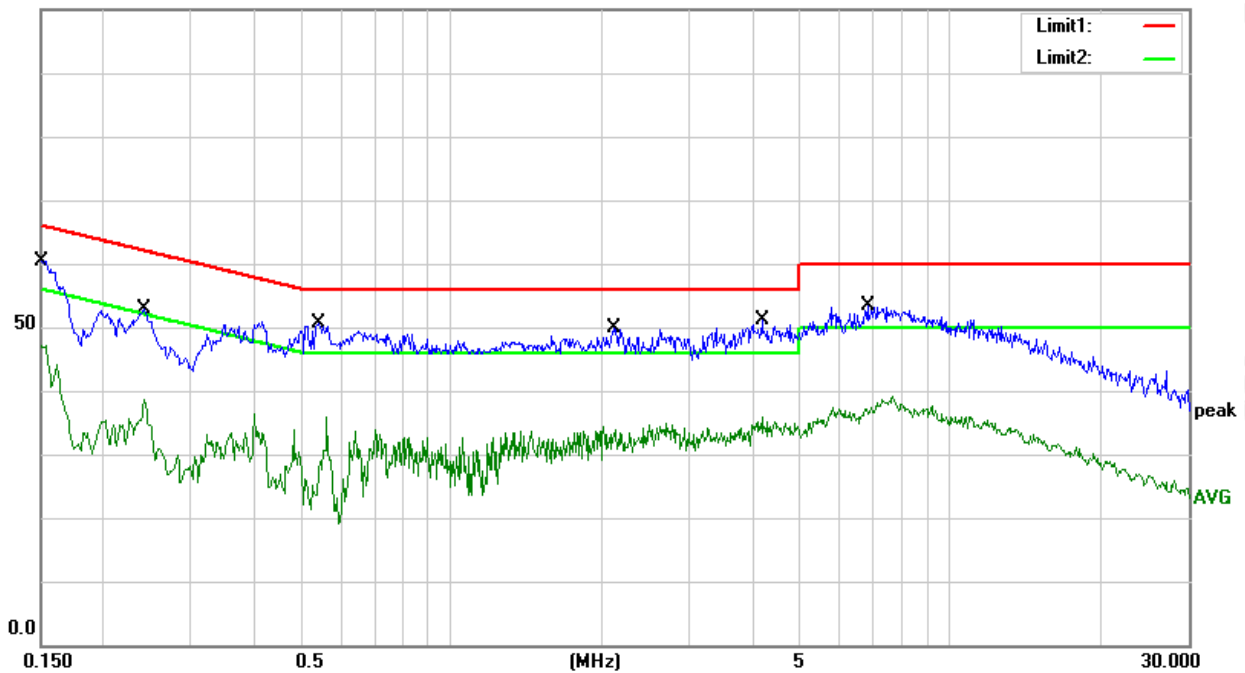

3.2 RADIATED EMISSION AND MEASUREMENT

3.2.1 RADIATED EMISSION LIMITS (Frequency Range 9kHz-1000MHz)

In case the emission fall within the restricted band specified on 15.407(b)7&209(a), then the limit in the table below has to be followed.

Frequencies (MHz)	Field Strength (micorvolts/meter)	Measurement Distance (meters)
0.009~0.490	2400/F(KHz)	300
0.490~1.705	24000/F(KHz)	30
1.705~30.0	30	30
30~88	100	3
88~216	150	3
216~960	200	3
Above 960	500	3

LIMITS OF RADIATED EMISSION MEASUREMENT (Above 1000MHz)

FREQUENCY (MHz)	Class B (dBuV/m) (at 3M)	
	PEAK	AVERAGE
Above 1000	74	54

Notes:

- (1) The limit for radiated test was performed according to FCC PART 15E.
- (2) The tighter limit applies at the band edges.
- (3) Emission level (dBuV/m)=20log Emission level (uV/m).

LIMITS OF RESTRICTED FREQUENCY BANDS

FREQUENCY (MHz)	FREQUENCY (MHz)	FREQUENCY (MHz)	FREQUENCY (GHz)
0.090-0.110	16.42-16.423	399.9-410	4.5-5.15
0.495-0.505	16.69475-16.69525	608-614	5.35-5.46
2.1735-2.1905	16.80425-16.80475	960-1240	7.25-7.75
4.125-4.128	25.5-25.67	1300-1427	8.025-8.5
4.17725-4.17775	37.5-38.25	1435-1626.5	9.0-9.2
4.20725-4.20775	73-74.6	1645.5-1646.5	9.3-9.5
6.215-6.218	74.8-75.2	1660-1710	10.6-12.7
6.26775-6.26825	108-121.94	1718.8-1722.2	13.25-13.4
6.31175-6.31225	123-138	2200-2300	14.47-14.5
8.291-8.294	149.9-150.05	2310-2390	15.35-16.2
8.362-8.366	156.52475-156.52525	2483.5-2500	17.7-21.4
8.37625-8.38675	156.7-156.9	2690-2900	22.01-23.12
8.41425-8.41475	162.0125-167.17	3260-3267	23.6-24.0
12.29-12.293	167.72-173.2	3332-3339	31.2-31.8
12.51975-12.52025	240-285	3345.8-3358	36.43-36.5
12.57675-12.57725	322-335.4	3600-4400	Above 38.6
13.36-13.41			

LIMITS OF EMISSIONS OUTSIDE OF THE FREQUENCY BANDS

Undesirable emission limits. Except as shown in paragraph (b)(7) of this section, the maximum emissions outside of the frequency bands of operation shall be attenuated in accordance with the following limits:

- (1) For transmitters operating in the 5.15-5.25 GHz band: All emissions outside of the 5.15-5.35 GHz band shall not exceed an e.i.r.p. of -27 dBm/MHz.
- (2) For transmitters operating in the 5.25-5.35 GHz band: All emissions outside of the 5.15-5.35 GHz band shall not exceed an e.i.r.p. of -27 dBm/MHz.
- (3) For transmitters operating in the 5.47-5.725 GHz band: All emissions outside of the 5.47-5.725 GHz band shall not exceed an e.i.r.p. of -27 dBm/MHz.
- (4) For transmitters operating in the 5.725-5.85 GHz band:
 - (i) All emissions shall be limited to a level of -27 dBm/MHz at 75 MHz or more above or below the band edge increasing linearly to 10 dBm/MHz at 25 MHz above or below the band edge, and from 25 MHz above or below the band edge increasing linearly to a level of 15.6 dBm/MHz at 5 MHz above or below the band edge, and from 5 MHz above or below the band edge increasing linearly to a level of 27 dBm/MHz at the band edge.

Note: dBuV/m(at 3M) = EIRP(dBm) + 95.2.

Peak Limit = -27dBm/MHz + 95.2 = 68.2 dBuV/m.

Spectrum Parameter	Setting
Attenuation	Auto
Detector	Peak
Start Frequency	1000 MHz(Peak/AV)
Stop Frequency	10th carrier harmonic (Peak/AV)
RB / VB (emission in restricted band)	1 MHz / 1 MHz, AV=1 MHz /3 MHz



For Band edge

Spectrum Parameter	Setting
Detector	Peak
RB / VB (emission in restricted band)	1 MHz / 1 MHz, AV=1 MHz /3 MHz

Receiver Parameter	Setting
Attenuation	Auto
Start ~ Stop Frequency	9kHz~90kHz / RB 200Hz for PK & AV
Start ~ Stop Frequency	90kHz~110kHz / RB 200Hz for QP
Start ~ Stop Frequency	110kHz~490kHz / RB 200Hz for PK & AV
Start ~ Stop Frequency	490kHz~30MHz / RB 9kHz for QP
Start ~ Stop Frequency	30MHz~1000MHz / RB 120kHz for QP

3.2.2 TEST PROCEDURE

- a. The measuring distance at 3 m shall be used for measurements at frequency 0.009MHz up to 1GHz, and above 1GHz.
- b. The EUT was placed on the top of a rotating table 0.8 m (above 1GHz is 1.5 m) above the ground at a 3 m anechoic chamber test site. The table was rotated 360 degree to determine the position of the highest radiation.
- c. The height of the equipment shall be 0.8 m (above 1GHz is 1.5 m); the height of the test antenna shall vary between 1 m to 4 m. Horizontal and vertical polarization of the antenna are set to make the measurement.
- d. The initial step in collecting conducted emission data is a spectrum analyzer peak detector mode pre-scanning the measurement frequency range. Significant peaks are then marked and QuasiPeak detector mode will be re-measured.
- e. If the Peak Mode measured value is compliance with and lower than Quasi Peak Mode Limit, the EUT shall be deemed to meet QP Limits and no additional QP Mode measurement was performed.
- f. For the actual test configuration, please refer to the related Item –EUT Test Photos.

Note:

Both horizontal and vertical antenna polarities were tested and performed pretest to three orthogonal axis. The worst case emissions were reported.

3.2.3 DEVIATION FROM TEST STANDARD

No deviation

3.2.4 TEST SETUP

(A) Radiated Emission Test-Up Frequency Below 30MHz

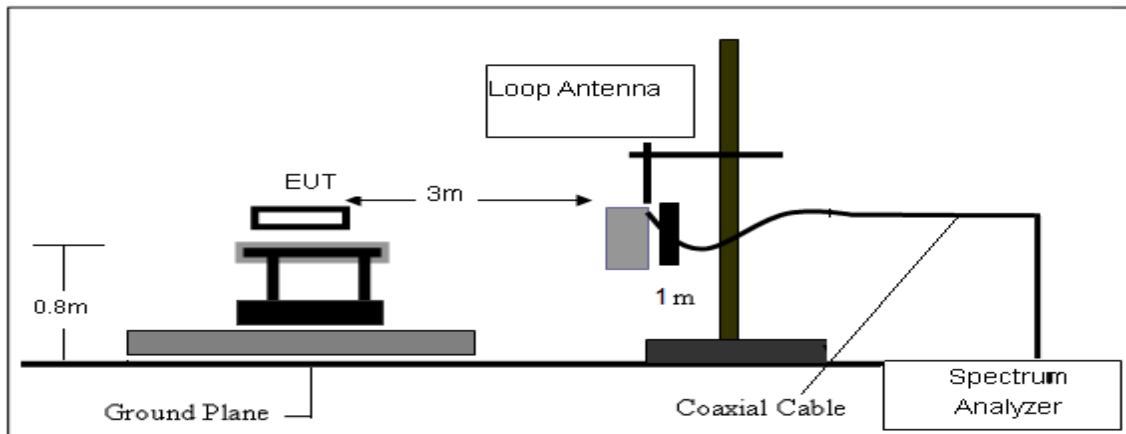

(B) Radiated Emission Test-Up Frequency 30MHz~1GHz

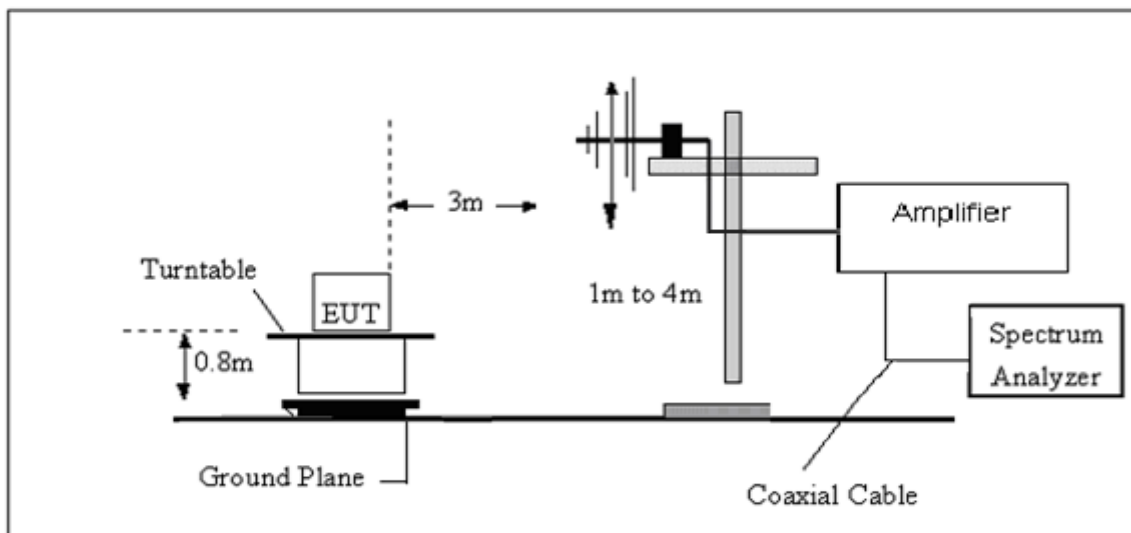

(C) Radiated Emission Test-Up Frequency Above 1GHz

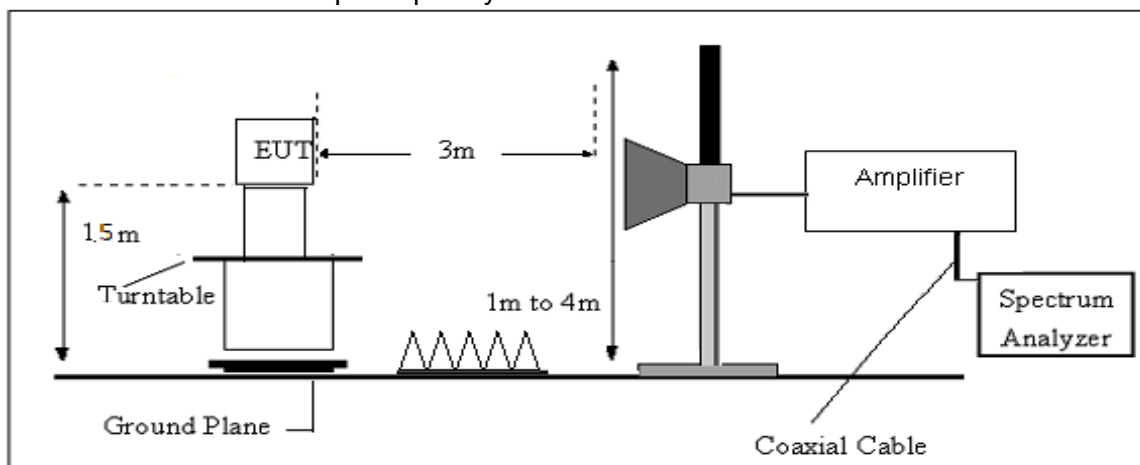

3.2.5 EUT OPERATING CONDITIONS

The EUT tested system was configured as the statements of 2.4 Unless otherwise a special operating condition is specified in the follows during the testing.

3.2.6 FIELD STRENGTH CALCULATION

The field strength is calculated by adding the Antenna Factor and Cable Factor and subtracting the Amplifier Gain and Duty Cycle Correction Factor (if any) from the measured reading. The basic equation with a sample calculation is as follows:

$$FS = RA + AF + CL - AG$$

Where

FS = Field Strength

CL = Cable Attenuation Factor (Cable Loss)

RA = Reading Amplitude

AG = Amplifier Gain

AF = Antenna Factor

For example

Frequency (MHz)	FS (dB μ V/m)	RA (dB μ V/m)	AF (dB)	CL (dB)	AG (dB)	Factor (dB)
300	40	58.1	12.2	1.6	31.9	-18.1

$$\text{Factor} = \text{AF} + \text{CL} - \text{AG}$$



3.2.7 TEST RESULTS (Between 9KHz – 30 MHz)

Temperature:	23.4°C	Relative Humidity:	60%
Test Voltage:	DC 3.7V	Polarization :	--
Test Mode:	TX Mode		

Freq. (MHz)	Reading (dBuV/m)	Limit (dBuV/m)	Margin (dB)	State P/F
--	--	--	--	PASS
--	--	--	--	PASS

Note:

The amplitude of spurious emissions which are attenuated by more than 20dB below the permissible value has no need to be reported.

Distance extrapolation factor = $40 \log(\text{specific distance}/\text{test distance})$ (dB);

Limit line = specific limits(dBuv) + distance extrapolation factor.

3.2.8 TEST RESULTS (Between 30MHz – 1GHz)

Temperature	23.4°C	Relative Humidity:	60%
Test Voltage	DC 3.7V	Polarization :	Horizontal
Test Mode	Mode 1~12(Mode 12 worst mode)		

No.	Frequency (MHz)	Reading (dBuV)	Correct Factor(dB/m)	Result (dBuV/m)	Limit (dBuV/m)	Margin (dB)	Remark
1	30.6380	28.23	-13.18	15.05	40.00	-24.95	peak
2	260.8600	28.73	-14.78	13.95	46.00	-32.05	peak
3	420.9100	30.00	-10.09	19.91	46.00	-26.09	peak
4	562.5300	28.65	-5.52	23.13	46.00	-22.87	peak
5	733.2500	30.58	-2.35	28.23	46.00	-17.77	peak
6	975.7500	29.05	2.38	31.43	54.00	-22.57	peak

Remark:

1. Margin = Result (Result =Reading + Factor)–Limit
2. Factor= Antenna factor+Cable attenuation factor(cable loss)-Amplifier gain

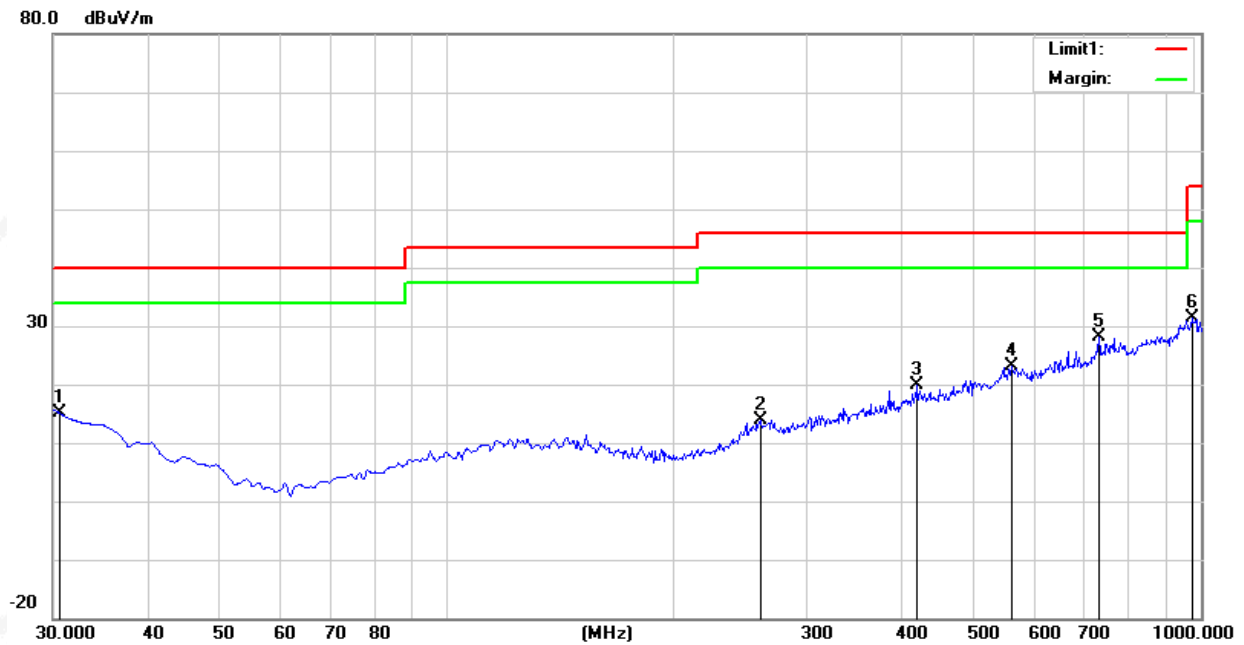



Temperature	23.4°C	Relative Humidity:	60%
Test Voltage	DC 3.7V	Polarization :	Vertical
Test Mode	Mode 1~12(Mode 12 worst mode)		

No.	Frequency (MHz)	Reading (dBuV)	Correct Factor(dB/m)	Result (dBuV/m)	Limit (dBuV/m)	Margin (dB)	Remark
1	30.7455	29.23	-13.24	15.99	40.00	-24.01	peak
2	422.8500	28.80	-10.11	18.69	46.00	-27.31	peak
3	473.2900	28.77	-8.89	19.88	46.00	-26.12	peak
4	627.5200	29.01	-5.15	23.86	46.00	-22.14	peak
5	759.4400	30.50	-2.16	28.34	46.00	-17.66	peak
6	983.5100	28.29	2.46	30.75	54.00	-23.25	peak

Remark:

3. Margin = Result (Result =Reading + Factor)-Limit

4. Factor= Antenna factor+Cable attenuation factor(cable loss)-Amplifier gain

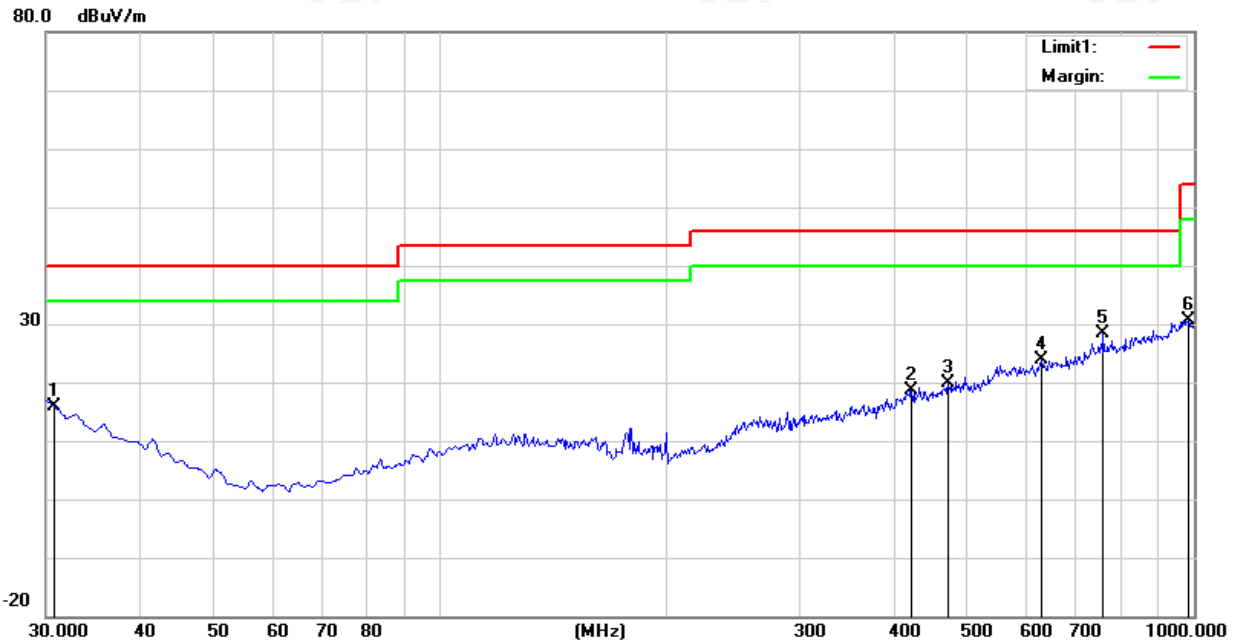



3.2.8 TEST RESULTS (Above 1000 MHz)

U-NII-1 5150-5250MHz

U-NII 1(5.15-5.25) GHz										
Frequency (MHz)	Reading	Amplifier	Loss	Antenna Factor	Orrected Factor	Emission Level	Limit (dBuV/m)	Margin (dB)	Detector	Comment
	(dBuV)	(dB)	(dB)	(dB/m)	(dB)	(dBuV/m)				
Low Channel (802.11n20/ 5180 MHz)										
3249.59	45.12	44.70	6.70	28.20	-9.80	35.32	68.20	-32.88	Pk	Vertical
3249.59	41.45	44.70	6.70	28.20	-9.80	31.65	54.00	-22.35	AV	Vertical
3265.14	43.80	44.70	6.70	28.20	-9.80	34.00	74.00	-40.00	Pk	Horizontal
3265.14	41.33	44.70	6.70	28.20	-9.80	31.53	54.00	-22.47	AV	Horizontal
3994.35	39.77	44.20	7.90	29.70	-6.60	33.17	74.00	-40.83	Pk	Vertical
3994.35	36.99	44.20	7.90	29.70	-6.60	30.39	54.00	-23.61	AV	Vertical
3986.69	38.70	44.20	7.90	29.70	-6.60	32.10	74.00	-41.90	Pk	Horizontal
3986.69	37.02	44.20	7.90	29.70	-6.60	30.42	54.00	-23.58	AV	Horizontal
7227.76	36.91	43.50	11.40	35.50	3.40	40.31	68.20	-27.89	Pk	Vertical
7227.76	33.84	43.50	11.40	35.50	3.40	37.24	54.00	-16.76	AV	Vertical
7229.56	36.49	43.50	11.40	35.50	3.40	39.89	68.20	-28.31	Pk	Horizontal
7229.56	33.75	43.50	11.40	35.50	3.40	37.15	54.00	-16.85	AV	Horizontal
10360.12	39.88	44.50	13.80	38.80	8.10	47.98	68.20	-20.22	Pk	Vertical
10360.12	36.08	44.50	13.80	38.80	8.10	44.18	54.00	-9.82	AV	Vertical
10360.43	39.00	44.50	13.80	38.80	8.10	47.10	68.20	-21.10	Pk	Horizontal
10360.43	36.66	44.50	13.80	38.80	8.10	44.76	54.00	-9.24	AV	Horizontal
11018.62	33.89	43.60	14.30	39.50	10.20	44.09	74.00	-29.91	Pk	Vertical
11018.62	30.32	43.60	14.30	39.50	10.20	40.52	54.00	-13.48	AV	Vertical
11032.37	33.29	43.60	14.30	39.50	10.20	43.49	74.00	-30.51	Pk	Horizontal
11032.37	29.93	43.60	14.30	39.50	10.20	40.13	54.00	-13.87	AV	Horizontal
13289.05	31.95	42.60	15.90	38.90	12.20	44.15	74.00	-29.85	Pk	Vertical
13289.05	29.73	42.60	15.90	38.90	12.20	41.93	54.00	-12.07	AV	Vertical
13297.46	32.12	42.60	15.90	38.90	12.20	44.32	74.00	-29.68	Pk	Horizontal
13297.46	29.48	42.60	15.90	38.90	12.20	41.68	54.00	-12.32	AV	Horizontal
Mid Channel (802.11n20/ 5200 MHz)										
3260.78	45.10	44.70	6.70	28.20	-9.80	35.30	74.00	-38.70	Pk	Vertical
3260.78	40.82	44.70	6.70	28.20	-9.80	31.02	54.00	-22.98	AV	Vertical
3256.25	45.00	44.70	6.70	28.20	-9.80	35.20	68.20	-33.00	Pk	Horizontal
3256.25	41.14	44.70	6.70	28.20	-9.80	31.34	54.00	-22.66	AV	Horizontal
3981.37	39.01	44.20	7.90	29.70	-6.60	32.41	74.00	-41.59	Pk	Vertical
3981.37	35.96	44.20	7.90	29.70	-6.60	29.36	54.00	-24.64	AV	Vertical
3992.18	39.98	44.20	7.90	29.70	-6.60	33.38	74.00	-40.62	Pk	Horizontal
3992.18	36.38	44.20	7.90	29.70	-6.60	29.78	54.00	-24.22	AV	Horizontal
7219.22	37.56	43.50	11.40	35.50	3.40	40.96	68.20	-27.24	Pk	Vertical
7219.22	33.75	43.50	11.40	35.50	3.40	37.15	54.00	-16.85	AV	Vertical
7224.59	36.90	43.50	11.40	35.50	3.40	40.30	68.20	-27.90	Pk	Horizontal
7224.59	34.89	43.50	11.40	35.50	3.40	38.29	54.00	-15.71	AV	Horizontal
10400.21	40.02	44.50	13.80	38.80	8.10	48.12	68.20	-20.08	Pk	Vertical
10400.21	36.68	44.50	13.80	38.80	8.10	44.78	54.00	-9.22	AV	Vertical
10400.07	40.00	44.50	13.80	38.80	8.10	48.10	68.20	-20.10	Pk	Horizontal
10400.07	36.30	44.50	13.80	38.80	8.10	44.40	54.00	-9.60	AV	Horizontal
11028.61	34.09	43.60	14.30	39.50	10.20	44.29	74.00	-29.71	Pk	Vertical
11028.61	29.89	43.60	14.30	39.50	10.20	40.09	54.00	-13.91	AV	Vertical
11019.02	33.10	43.60	14.30	39.50	10.20	43.30	74.00	-30.70	Pk	Horizontal
11019.02	31.11	43.60	14.30	39.50	10.20	41.31	54.00	-12.69	AV	Horizontal
13298.19	31.63	42.60	15.90	38.90	12.20	43.83	74.00	-30.17	Pk	Vertical
13298.19	29.29	42.60	15.90	38.90	12.20	41.49	54.00	-12.51	AV	Vertical
13297.94	32.31	42.60	15.90	38.90	12.20	44.51	74.00	-29.49	Pk	Horizontal
13297.94	28.62	42.60	15.90	38.90	12.20	40.82	54.00	-13.18	AV	Horizontal



High Channel (802.11n20/ 5240 MHz)										
3250.80	44.72	44.70	6.70	28.20	-9.80	34.92	68.20	-33.28	Pk	Vertical
3250.80	41.79	44.70	6.70	28.20	-9.80	31.99	54.00	-22.01	AV	Vertical
3249.48	43.93	44.70	6.70	28.20	-9.80	34.13	68.20	-34.07	Pk	Horizontal
3249.48	42.16	44.70	6.70	28.20	-9.80	32.36	54.00	-21.64	AV	Horizontal
3989.96	39.95	44.20	7.90	29.70	-6.60	33.35	74.00	-40.65	Pk	Vertical
3989.96	36.56	44.20	7.90	29.70	-6.60	29.96	54.00	-24.04	AV	Vertical
3988.54	39.27	44.20	7.90	29.70	-6.60	32.67	74.00	-41.33	Pk	Horizontal
3988.54	36.67	44.20	7.90	29.70	-6.60	30.07	54.00	-23.93	AV	Horizontal
7226.49	37.56	43.50	11.40	35.50	3.40	40.96	68.20	-27.24	Pk	Vertical
7226.49	33.99	43.50	11.40	35.50	3.40	37.39	54.00	-16.61	AV	Vertical
7231.77	37.63	43.50	11.40	35.50	3.40	41.03	68.20	-27.17	Pk	Horizontal
7231.77	34.25	43.50	11.40	35.50	3.40	37.65	54.00	-16.35	AV	Horizontal
10479.98	39.37	44.50	13.80	38.80	8.10	47.47	68.20	-20.73	Pk	Vertical
10479.98	36.65	44.50	13.80	38.80	8.10	44.75	54.00	-9.25	AV	Vertical
10480.37	38.95	44.50	13.80	38.80	8.10	47.05	68.20	-21.15	Pk	Horizontal
10480.37	36.69	44.50	13.80	38.80	8.10	44.79	54.00	-9.21	AV	Horizontal
11030.42	33.73	43.60	14.30	39.50	10.20	43.93	74.00	-30.07	Pk	Vertical
11030.42	30.07	43.60	14.30	39.50	10.20	40.27	54.00	-13.73	AV	Vertical
11024.67	33.53	43.60	14.30	39.50	10.20	43.73	74.00	-30.27	Pk	Horizontal
11024.67	29.88	43.60	14.30	39.50	10.20	40.08	54.00	-13.92	AV	Horizontal
13297.85	32.31	42.60	15.90	38.90	12.20	44.51	74.00	-29.49	Pk	Vertical
13297.85	29.19	42.60	15.90	38.90	12.20	41.39	54.00	-12.61	AV	Vertical
13297.11	32.24	42.60	15.90	38.90	12.20	44.44	74.00	-29.56	Pk	Horizontal
13297.11	28.71	42.60	15.90	38.90	12.20	40.91	54.00	-13.09	AV	Horizontal

Remark:

1. Factor = Antenna Factor + Cable Loss – Pre-amplifier.
2. All modes have been measurement, only worst mode was reported.
3. The frequency emission of peak points that did not show above the forms are at least 20dB below the limit, the frequency emission is mainly from the environment noise.



U-NII-2A 5250-5350MHz

U-NII 2A(5.25-5.35) GHz										
Frequency (MHz)	Reading	Amplifier	Loss	Antenna Factor	Orrected Factor	Emission Level	Limit (dBuV/m)	Margin	Detector	Comment
	(dBuV)	(dB)	(dB)	(dB/m)	(dB)	(dBuV/m)		(dB)		
Low Channel (802.11n20/ 5260 MHz)										
3261.17	45.26	44.70	6.70	28.20	-9.80	35.46	74.00	-38.54	Pk	Vertical
3261.17	42.13	44.70	6.70	28.20	-9.80	32.33	54.00	-21.67	AV	Vertical
3254.38	43.90	44.70	6.70	28.20	-9.80	34.10	68.20	-34.10	Pk	Horizontal
3254.38	41.95	44.70	6.70	28.20	-9.80	32.15	54.00	-21.85	AV	Horizontal
3986.26	39.69	44.20	7.90	29.70	-6.60	33.09	74.00	-40.91	Pk	Vertical
3986.26	35.77	44.20	7.90	29.70	-6.60	29.17	54.00	-24.83	AV	Vertical
3997.80	39.62	44.20	7.90	29.70	-6.60	33.02	74.00	-40.98	Pk	Horizontal
3997.80	36.84	44.20	7.90	29.70	-6.60	30.24	54.00	-23.76	AV	Horizontal
7231.44	36.70	43.50	11.40	35.50	3.40	40.10	68.20	-28.10	Pk	Vertical
7231.44	33.54	43.50	11.40	35.50	3.40	36.94	54.00	-17.06	AV	Vertical
7223.74	37.39	43.50	11.40	35.50	3.40	40.79	68.20	-27.41	Pk	Horizontal
7223.74	34.57	43.50	11.40	35.50	3.40	37.97	54.00	-16.03	AV	Horizontal
10520.19	39.01	44.50	13.90	38.80	8.20	47.21	68.20	-20.99	Pk	Vertical
10520.19	36.20	44.50	13.90	38.80	8.20	44.40	54.00	-9.60	AV	Vertical
10520.22	38.71	44.50	13.90	38.80	8.20	46.91	68.20	-21.29	Pk	Horizontal
10520.22	36.36	44.50	13.90	38.80	8.20	44.56	54.00	-9.44	AV	Horizontal
11029.63	33.17	43.60	14.30	39.50	10.20	43.37	74.00	-30.63	Pk	Vertical
11029.63	31.09	43.60	14.30	39.50	10.20	41.29	54.00	-12.71	AV	Vertical
11026.65	34.00	43.60	14.30	39.50	10.20	44.20	74.00	-29.80	Pk	Horizontal
11026.65	30.39	43.60	14.30	39.50	10.20	40.59	54.00	-13.41	AV	Horizontal
13295.98	32.69	42.60	15.90	38.90	12.20	44.89	74.00	-29.11	Pk	Vertical
13295.98	28.71	42.60	15.90	38.90	12.20	40.91	54.00	-13.09	AV	Vertical
13298.46	31.79	42.60	15.90	38.90	12.20	43.99	74.00	-30.01	Pk	Horizontal
13298.46	29.38	42.60	15.90	38.90	12.20	41.58	54.00	-12.42	AV	Horizontal
Mid Channel (802.11n20/ 5300 MHz)										
3248.81	43.97	44.70	6.70	28.20	-9.80	34.17	68.20	-34.03	Pk	Vertical
3248.81	41.95	44.70	6.70	28.20	-9.80	32.15	54.00	-21.85	AV	Vertical
3262.15	44.52	44.70	6.70	28.20	-9.80	34.72	74.00	-39.28	Pk	Horizontal
3262.15	41.05	44.70	6.70	28.20	-9.80	31.25	54.00	-22.75	AV	Horizontal
3988.91	39.90	44.20	7.90	29.70	-6.60	33.30	74.00	-40.70	Pk	Vertical
3988.91	37.00	44.20	7.90	29.70	-6.60	30.40	54.00	-23.60	AV	Vertical
3995.00	39.75	44.20	7.90	29.70	-6.60	33.15	74.00	-40.85	Pk	Horizontal
3995.00	36.64	44.20	7.90	29.70	-6.60	30.04	54.00	-23.96	AV	Horizontal
7221.59	37.57	43.50	11.40	35.50	3.40	40.97	68.20	-27.23	Pk	Vertical
7221.59	34.52	43.50	11.40	35.50	3.40	37.92	54.00	-16.08	AV	Vertical
7233.81	37.05	43.50	11.40	35.50	3.40	40.45	68.20	-27.75	Pk	Horizontal
7233.81	34.52	43.50	11.40	35.50	3.40	37.92	54.00	-16.08	AV	Horizontal
10600.28	39.95	44.50	13.80	38.80	8.10	48.05	74.00	-25.95	Pk	Vertical
10600.28	36.29	44.50	13.80	38.80	8.10	44.39	54.00	-9.61	AV	Vertical
10600.36	39.40	44.50	13.80	38.80	8.10	47.50	74.00	-26.50	Pk	Horizontal
10600.36	36.32	44.50	13.80	38.80	8.10	44.42	54.00	-9.58	AV	Horizontal
11026.82	33.96	43.60	14.30	39.50	10.20	44.16	74.00	-29.84	Pk	Vertical
11026.82	29.92	43.60	14.30	39.50	10.20	40.12	54.00	-13.88	AV	Vertical
11032.58	33.49	43.60	14.30	39.50	10.20	43.69	74.00	-30.31	Pk	Horizontal
11032.58	30.26	43.60	14.30	39.50	10.20	40.46	54.00	-13.54	AV	Horizontal
13299.03	32.15	42.60	15.90	38.90	12.20	44.35	74.00	-29.65	Pk	Vertical
13299.03	29.94	42.60	15.90	38.90	12.20	42.14	54.00	-11.86	AV	Vertical
13280.76	32.96	42.60	15.90	38.90	12.20	45.16	74.00	-28.84	Pk	Horizontal
13280.76	29.48	42.60	15.90	38.90	12.20	41.68	54.00	-12.32	AV	Horizontal



High Channel (802.11n20/ 5320 MHz)										
3255.85	44.00	44.70	6.70	28.20	-9.80	34.20	68.20	-34.00	Pk	Vertical
3255.85	42.02	44.70	6.70	28.20	-9.80	32.22	54.00	-21.78	AV	Vertical
3254.71	44.87	44.70	6.70	28.20	-9.80	35.07	68.20	-33.13	Pk	Horizontal
3254.71	41.59	44.70	6.70	28.20	-9.80	31.79	54.00	-22.21	AV	Horizontal
3987.82	39.40	44.20	7.90	29.70	-6.60	32.80	74.00	-41.20	Pk	Vertical
3987.82	36.93	44.20	7.90	29.70	-6.60	30.33	54.00	-23.67	AV	Vertical
3995.27	38.68	44.20	7.90	29.70	-6.60	32.08	74.00	-41.92	Pk	Horizontal
3995.27	35.95	44.20	7.90	29.70	-6.60	29.35	54.00	-24.65	AV	Horizontal
7228.60	36.59	43.50	11.40	35.50	3.40	39.99	68.20	-28.21	Pk	Vertical
7228.60	34.02	43.50	11.40	35.50	3.40	37.42	54.00	-16.58	AV	Vertical
7229.58	37.76	43.50	11.40	35.50	3.40	41.16	68.20	-27.04	Pk	Horizontal
7229.58	33.78	43.50	11.40	35.50	3.40	37.18	54.00	-16.82	AV	Horizontal
10640.42	38.91	44.50	13.80	38.80	8.10	47.01	74.00	-26.99	Pk	Vertical
10640.42	36.59	44.50	13.80	38.80	8.10	44.69	54.00	-9.31	AV	Vertical
10640.11	38.83	44.50	13.80	38.80	8.10	46.93	74.00	-27.07	Pk	Horizontal
10640.11	36.47	44.50	13.80	38.80	8.10	44.57	54.00	-9.43	AV	Horizontal
11033.60	33.74	43.60	14.30	39.50	10.20	43.94	74.00	-30.06	Pk	Vertical
11033.60	30.90	43.60	14.30	39.50	10.20	41.10	54.00	-12.90	AV	Vertical
11029.32	33.57	43.60	14.30	39.50	10.20	43.77	74.00	-30.23	Pk	Horizontal
11029.32	29.99	43.60	14.30	39.50	10.20	40.19	54.00	-13.81	AV	Horizontal
13297.99	32.68	42.70	18.00	37.10	12.40	45.08	74.00	-28.92	Pk	Vertical
13297.99	29.32	42.70	18.00	37.10	12.40	41.72	54.00	-12.28	AV	Vertical
13282.77	32.38	42.70	18.00	37.10	12.40	44.78	74.00	-29.22	Pk	Horizontal
13282.77	29.51	42.70	18.00	37.10	12.40	41.91	54.00	-12.09	AV	Horizontal

Remark:

1. Factor = Antenna Factor + Cable Loss – Pre-amplifier.
2. All modes have been measurement, only worst mode was reported.
3. The frequency emission of peak points that did not show above the forms are at least 20dB below the limit, the frequency emission is mainly from the environment noise.



U-NII-2C 5470-5725MHz

U-NII 2C(5.47-5.725) GHz										
Frequency (MHz)	Reading	Amplifier	Loss	Antenna Factor	Orrected Factor	Emission Level	Limit (dBuV/m)	Margin	Detector	Comment
	(dBuV)	(dB)	(dB)	(dB/m)	(dB)	(dBuV/m)		(dB)		
Low Channel (802.11n20/ 5500 MHz)										
3252.20	44.17	44.70	6.70	28.20	-9.80	34.37	68.20	-33.83	Pk	Vertical
3252.20	41.27	44.70	6.70	28.20	-9.80	31.47	54.00	-22.53	AV	Vertical
3261.76	44.43	44.70	6.70	28.20	-9.80	34.63	74.00	-39.37	Pk	Horizontal
3261.76	41.29	44.70	6.70	28.20	-9.80	31.49	54.00	-22.51	AV	Horizontal
3981.96	39.73	44.20	7.90	29.70	-6.60	33.13	74.00	-40.87	Pk	Vertical
3981.96	37.03	44.20	7.90	29.70	-6.60	30.43	54.00	-23.57	AV	Vertical
3988.04	39.02	44.20	7.90	29.70	-6.60	32.42	74.00	-41.58	Pk	Horizontal
3988.04	36.81	44.20	7.90	29.70	-6.60	30.21	54.00	-23.79	AV	Horizontal
7218.33	36.72	43.50	11.40	35.50	3.40	40.12	68.20	-28.08	Pk	Vertical
7218.33	34.58	43.50	11.40	35.50	3.40	37.98	54.00	-16.02	AV	Vertical
7229.15	37.61	43.50	11.40	35.50	3.40	41.01	68.20	-27.19	Pk	Horizontal
7229.15	34.13	43.50	11.40	35.50	3.40	37.53	54.00	-16.47	AV	Horizontal
10346.02	39.17	44.50	13.80	38.80	8.10	47.27	68.20	-20.93	Pk	Vertical
10346.02	37.11	44.50	13.80	38.80	8.10	45.21	54.00	-8.79	AV	Vertical
10347.79	39.94	44.50	13.80	38.80	8.10	48.04	68.20	-20.16	Pk	Horizontal
10347.79	36.76	44.50	13.80	38.80	8.10	44.86	54.00	-9.14	AV	Horizontal
11000.38	33.98	43.60	14.30	39.50	10.20	44.18	74.00	-29.82	Pk	Vertical
11000.38	30.11	43.60	14.30	39.50	10.20	40.31	54.00	-13.69	AV	Vertical
11000.11	33.82	43.60	14.30	39.50	10.20	44.02	74.00	-29.98	Pk	Horizontal
11000.11	30.26	43.60	14.30	39.50	10.20	40.46	54.00	-13.54	AV	Horizontal
13285.74	32.83	42.60	15.90	38.90	12.20	45.03	74.00	-28.97	Pk	Vertical
13285.74	28.88	42.60	15.90	38.90	12.20	41.08	54.00	-12.92	AV	Vertical
13294.71	32.24	42.60	15.90	38.90	12.20	44.44	74.00	-29.56	Pk	Horizontal
13294.71	29.02	42.60	15.90	38.90	12.20	41.22	54.00	-12.78	AV	Horizontal
Mid Channel (802.11n20/ 5580 MHz)										
3258.50	44.92	44.70	6.70	28.20	-9.80	35.12	68.20	-33.08	Pk	Vertical
3258.50	42.06	44.70	6.70	28.20	-9.80	32.26	54.00	-21.74	AV	Vertical
3245.45	44.51	44.70	6.70	28.20	-9.80	34.71	68.20	-33.49	Pk	Horizontal
3245.45	41.76	44.70	6.70	28.20	-9.80	31.96	54.00	-22.04	AV	Horizontal
3996.88	39.78	44.20	7.90	29.70	-6.60	33.18	74.00	-40.82	Pk	Vertical
3996.88	35.78	44.20	7.90	29.70	-6.60	29.18	54.00	-24.82	AV	Vertical
3999.35	39.75	44.20	7.90	29.70	-6.60	33.15	74.00	-40.85	Pk	Horizontal
3999.35	36.05	44.20	7.90	29.70	-6.60	29.45	54.00	-24.55	AV	Horizontal
7235.44	37.54	43.50	11.40	35.50	3.40	40.94	68.20	-27.26	Pk	Vertical
7235.44	34.91	43.50	11.40	35.50	3.40	38.31	54.00	-15.69	AV	Vertical
7226.34	36.45	43.50	11.40	35.50	3.40	39.85	68.20	-28.35	Pk	Horizontal
7226.34	34.31	43.50	11.40	35.50	3.40	37.71	54.00	-16.29	AV	Horizontal
10381.00	39.41	44.50	13.80	38.80	8.10	47.51	68.20	-20.69	Pk	Vertical
10381.00	35.81	44.50	13.80	38.80	8.10	43.91	54.00	-10.09	AV	Vertical
10388.69	39.07	44.50	13.80	38.80	8.10	47.17	68.20	-21.03	Pk	Horizontal
10388.69	36.91	44.50	13.80	38.80	8.10	45.01	54.00	-8.99	AV	Horizontal
11160.39	33.75	43.60	14.30	39.50	10.20	43.95	74.00	-30.05	Pk	Vertical
11160.39	31.02	43.60	14.30	39.50	10.20	41.22	54.00	-12.78	AV	Vertical
11160.07	33.80	43.60	14.30	39.50	10.20	44.00	74.00	-30.00	Pk	Horizontal
11160.07	30.54	43.60	14.30	39.50	10.20	40.74	54.00	-13.26	AV	Horizontal
13290.93	32.52	42.60	15.90	38.90	12.20	44.72	74.00	-29.28	Pk	Vertical
13290.93	28.95	42.60	15.90	38.90	12.20	41.15	54.00	-12.85	AV	Vertical
13292.67	31.94	42.60	15.90	38.90	12.20	44.14	74.00	-29.86	Pk	Horizontal
13292.67	29.92	42.60	15.90	38.90	12.20	42.12	54.00	-11.88	AV	Horizontal



High Channel (802.11n20/ 5700 MHz)										
3264.43	44.18	44.70	6.70	28.20	-9.80	34.38	74.00	-39.62	Pk	Vertical
3264.43	41.66	44.70	6.70	28.20	-9.80	31.86	54.00	-22.14	AV	Vertical
3253.25	44.97	44.70	6.70	28.20	-9.80	35.17	68.20	-33.03	Pk	Horizontal
3253.25	40.89	44.70	6.70	28.20	-9.80	31.09	54.00	-22.91	AV	Horizontal
3996.49	40.03	44.20	7.90	29.70	-6.60	33.43	74.00	-40.57	Pk	Vertical
3996.49	36.26	44.20	7.90	29.70	-6.60	29.66	54.00	-24.34	AV	Vertical
3990.37	38.82	44.20	7.90	29.70	-6.60	32.22	74.00	-41.78	Pk	Horizontal
3990.37	36.84	44.20	7.90	29.70	-6.60	30.24	54.00	-23.76	AV	Horizontal
7220.82	36.77	43.50	11.40	35.50	3.40	40.17	68.20	-28.03	Pk	Vertical
7220.82	34.02	43.50	11.40	35.50	3.40	37.42	54.00	-16.58	AV	Vertical
7222.15	36.68	43.50	11.40	35.50	3.40	40.08	68.20	-28.12	Pk	Horizontal
7222.15	33.48	43.50	11.40	35.50	3.40	36.88	54.00	-17.12	AV	Horizontal
10473.28	40.06	44.50	13.80	38.80	8.10	48.16	68.20	-20.04	Pk	Vertical
10473.28	35.92	44.50	13.80	38.80	8.10	44.02	54.00	-9.98	AV	Vertical
10475.53	39.91	44.50	13.80	38.80	8.10	48.01	68.20	-20.19	Pk	Horizontal
10475.53	36.62	44.50	13.80	38.80	8.10	44.72	54.00	-9.28	AV	Horizontal
11400.31	33.24	43.60	14.30	39.50	10.20	43.44	74.00	-30.56	Pk	Vertical
11400.31	29.84	43.60	14.30	39.50	10.20	40.04	54.00	-13.96	AV	Vertical
11400.28	33.03	43.60	14.30	39.50	10.20	43.23	74.00	-30.77	Pk	Horizontal
11400.28	29.89	43.60	14.30	39.50	10.20	40.09	54.00	-13.91	AV	Horizontal
13295.30	32.27	42.60	15.90	38.90	12.20	44.47	74.00	-29.53	Pk	Vertical
13295.30	28.77	42.60	15.90	38.90	12.20	40.97	54.00	-13.03	AV	Vertical
13290.29	32.62	42.60	15.90	38.90	12.20	44.82	74.00	-29.18	Pk	Horizontal
13290.29	29.96	42.60	15.90	38.90	12.20	42.16	54.00	-11.84	AV	Horizontal

Remark:

1. Factor = Antenna Factor + Cable Loss – Pre-amplifier.
2. All modes have been measurement, only worst mode was reported.
3. The frequency emission of peak points that did not show above the forms are at least 20dB below the limit, the frequency emission is mainly from the environment noise.



U-NII-3 (5.725-5.850) GHz

U-NII 3(5.725-5.85) GHz										
Frequency (MHz)	Reading	Amplifier	Loss	Antenna Factor	Orrected Factor	Emission Level	Limit (dBuV/m)	Margin	Detector	Comment
	(dBuV)	(dB)	(dB)	(dB/m)	(dB)	(dBuV/m)		(dB)		
Low Channel (802.11a/ 5745 MHz)										
3246.34	43.94	44.70	6.70	28.20	-9.80	34.14	68.20	-34.06	Pk	Vertical
3246.34	41.26	44.70	6.70	28.20	-9.80	31.46	54.00	-22.54	AV	Vertical
3250.48	44.11	44.70	6.70	28.20	-9.80	34.31	68.20	-33.89	Pk	Horizontal
3250.48	42.18	44.70	6.70	28.20	-9.80	32.38	54.00	-21.62	AV	Horizontal
3990.88	39.31	44.20	7.90	29.70	-6.60	32.71	74.00	-41.29	Pk	Vertical
3990.88	35.93	44.20	7.90	29.70	-6.60	29.33	54.00	-24.67	AV	Vertical
3993.30	39.52	44.20	7.90	29.70	-6.60	32.92	74.00	-41.08	Pk	Horizontal
3993.30	36.05	44.20	7.90	29.70	-6.60	29.45	54.00	-24.55	AV	Horizontal
7233.73	37.51	43.50	11.40	35.50	3.40	40.91	68.20	-27.29	Pk	Vertical
7233.73	33.77	43.50	11.40	35.50	3.40	37.17	54.00	-16.83	AV	Vertical
7222.84	37.30	43.50	11.40	35.50	3.40	40.70	68.20	-27.50	Pk	Horizontal
7222.84	34.22	43.50	11.40	35.50	3.40	37.62	54.00	-16.38	AV	Horizontal
10511.34	39.95	44.50	13.90	38.80	8.20	48.15	68.20	-20.05	Pk	Vertical
10511.34	36.86	44.50	13.90	38.80	8.20	45.06	54.00	-8.94	AV	Vertical
10514.70	39.46	44.50	13.90	38.80	8.20	47.66	68.20	-20.54	Pk	Horizontal
10514.70	35.91	44.50	13.90	38.80	8.20	44.11	54.00	-9.89	AV	Horizontal
11489.98	33.59	43.60	14.30	39.50	10.20	43.79	74.00	-30.21	Pk	Vertical
11489.98	30.29	43.60	14.30	39.50	10.20	40.49	54.00	-13.51	AV	Vertical
11490.23	32.93	43.60	14.30	39.50	10.20	43.13	74.00	-30.87	Pk	Horizontal
11490.23	30.49	43.60	14.30	39.50	10.20	40.69	54.00	-13.31	AV	Horizontal
13286.66	32.44	42.60	15.90	38.90	12.20	44.64	74.00	-29.36	Pk	Vertical
13286.66	28.56	42.60	15.90	38.90	12.20	40.76	54.00	-13.24	AV	Vertical
13297.07	32.85	42.60	15.90	38.90	12.20	45.05	74.00	-28.95	Pk	Horizontal
13297.07	29.78	42.60	15.90	38.90	12.20	41.98	54.00	-12.02	AV	Horizontal
Mid Channel (802.11a 5785 MHz)										
3246.30	45.07	44.70	6.70	28.20	-9.80	35.27	68.20	-32.93	Pk	Vertical
3246.30	41.60	44.70	6.70	28.20	-9.80	31.80	54.00	-22.20	AV	Vertical
3258.47	44.82	44.70	6.70	28.20	-9.80	35.02	68.20	-33.18	Pk	Horizontal
3258.47	41.64	44.70	6.70	28.20	-9.80	31.84	54.00	-22.16	AV	Horizontal
3982.32	39.02	44.20	7.90	29.70	-6.60	32.42	74.00	-41.58	Pk	Vertical
3982.32	36.41	44.20	7.90	29.70	-6.60	29.81	54.00	-24.19	AV	Vertical
3985.66	39.79	44.20	7.90	29.70	-6.60	33.19	74.00	-40.81	Pk	Horizontal
3985.66	36.39	44.20	7.90	29.70	-6.60	29.79	54.00	-24.21	AV	Horizontal
7219.15	36.67	43.50	11.40	35.50	3.40	40.07	68.20	-28.13	Pk	Vertical
7219.15	34.07	43.50	11.40	35.50	3.40	37.47	54.00	-16.53	AV	Vertical
7221.97	36.73	43.50	11.40	35.50	3.40	40.13	68.20	-28.07	Pk	Horizontal
7221.97	33.91	43.50	11.40	35.50	3.40	37.31	54.00	-16.69	AV	Horizontal
10592.32	39.40	44.50	13.80	38.80	8.10	47.50	68.20	-20.70	Pk	Vertical
10592.32	36.47	44.50	13.80	38.80	8.10	44.57	54.00	-9.43	AV	Vertical
10599.11	38.70	44.50	13.80	38.80	8.10	46.80	68.20	-21.40	Pk	Horizontal
10599.11	36.85	44.50	13.80	38.80	8.10	44.95	54.00	-9.05	AV	Horizontal
11570.37	32.98	43.60	14.30	39.50	10.20	43.18	74.00	-30.82	Pk	Vertical
11570.37	29.95	43.60	14.30	39.50	10.20	40.15	54.00	-13.85	AV	Vertical
11569.99	33.41	43.60	14.30	39.50	10.20	43.61	74.00	-30.39	Pk	Horizontal
11569.99	30.71	43.60	14.30	39.50	10.20	40.91	54.00	-13.09	AV	Horizontal
13295.46	32.79	42.60	15.90	38.90	12.20	44.99	74.00	-29.01	Pk	Vertical
13295.46	29.13	42.60	15.90	38.90	12.20	41.33	54.00	-12.67	AV	Vertical
13294.36	31.98	42.60	15.90	38.90	12.20	44.18	74.00	-29.82	Pk	Horizontal
13294.36	28.88	42.60	15.90	38.90	12.20	41.08	54.00	-12.92	AV	Horizontal



High Channel (802.11a/ 5825 MHz)										
3249.32	45.05	44.70	6.70	28.20	-9.80	35.25	68.20	-32.95	Pk	Vertical
3249.32	41.50	44.70	6.70	28.20	-9.80	31.70	54.00	-22.30	AV	Vertical
3248.63	43.90	44.70	6.70	28.20	-9.80	34.10	68.20	-34.10	Pk	Horizontal
3248.63	41.73	44.70	6.70	28.20	-9.80	31.93	54.00	-22.07	AV	Horizontal
3995.02	39.27	44.20	7.90	29.70	-6.60	32.67	74.00	-41.33	Pk	Vertical
3995.02	36.62	44.20	7.90	29.70	-6.60	30.02	54.00	-23.98	AV	Vertical
3986.63	39.12	44.20	7.90	29.70	-6.60	32.52	74.00	-41.48	Pk	Horizontal
3986.63	35.88	44.20	7.90	29.70	-6.60	29.28	54.00	-24.72	AV	Horizontal
7227.69	36.62	43.50	11.40	35.50	3.40	40.02	68.20	-28.18	Pk	Vertical
7227.69	33.43	43.50	11.40	35.50	3.40	36.83	54.00	-17.17	AV	Vertical
7230.78	37.43	43.50	11.40	35.50	3.40	40.83	68.20	-27.37	Pk	Horizontal
7230.78	33.91	43.50	11.40	35.50	3.40	37.31	54.00	-16.69	AV	Horizontal
10627.97	39.94	44.50	13.80	38.80	8.10	48.04	74.00	-25.96	Pk	Vertical
10627.97	36.40	44.50	13.80	38.80	8.10	44.50	54.00	-9.50	AV	Vertical
10640.05	39.70	44.50	13.80	38.80	8.10	47.80	74.00	-26.20	Pk	Horizontal
10640.05	36.21	44.50	13.80	38.80	8.10	44.31	54.00	-9.69	AV	Horizontal
11650.34	33.69	43.60	14.30	39.50	10.20	43.89	74.00	-30.11	Pk	Vertical
11650.34	29.84	43.60	14.30	39.50	10.20	40.04	54.00	-13.96	AV	Vertical
11649.96	34.15	43.60	14.30	39.50	10.20	44.35	74.00	-29.65	Pk	Horizontal
11649.96	30.18	43.60	14.30	39.50	10.20	40.38	54.00	-13.62	AV	Horizontal
13283.16	31.56	42.70	18.00	37.10	12.40	43.96	74.00	-30.04	Pk	Vertical
13283.16	29.46	42.70	18.00	37.10	12.40	41.86	54.00	-12.14	AV	Vertical
13287.41	31.61	42.70	18.00	37.10	12.40	44.01	74.00	-29.99	Pk	Horizontal
13287.41	28.57	42.70	18.00	37.10	12.40	40.97	54.00	-13.03	AV	Horizontal

Remark:

1. Factor = Antenna Factor + Cable Loss – Pre-amplifier.
2. All modes have been measurement, only worst mode was reported.
3. The frequency emission of peak points that did not show above the forms are at least 20dB below the limit, the frequency emission is mainly from the environment noise.

3.2.9 TEST RESULTS(Band edge Requirements)

U-NII-1 (5.150-5.2500) GHz

802.11n20-L-H

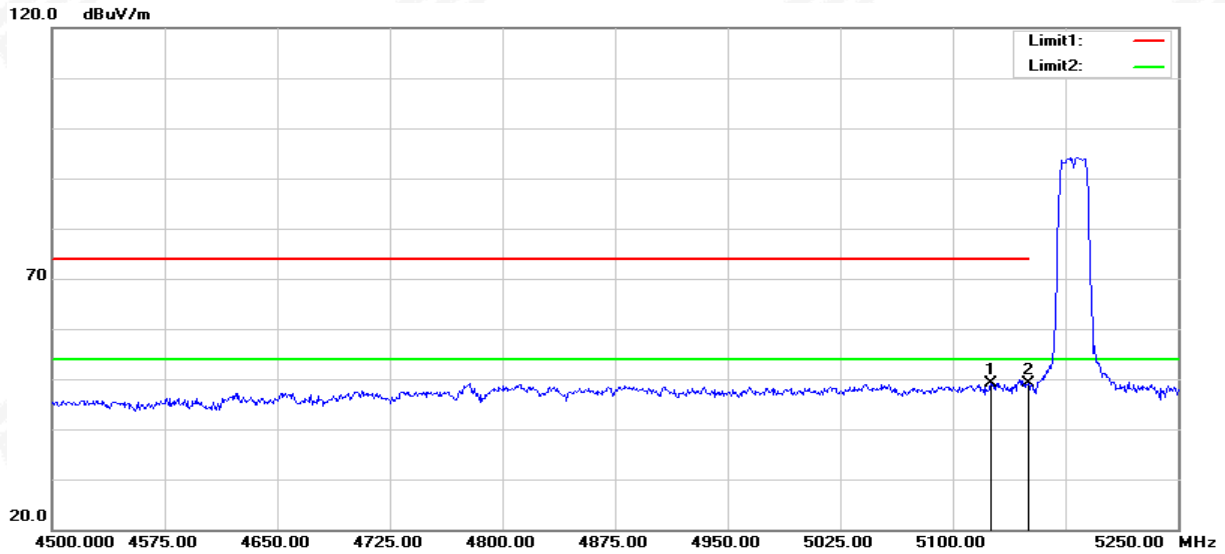

No.	Frequency (MHz)	Reading (dBuV)	Correct Factor(dB/m)	Result (dBuV/m)	Limit (dBuV/m)	Margin (dB)	Remark
1	5125.500	54.89	-5.74	49.15	54.00	-4.85	peak
2	5150.000	54.94	-5.73	49.21	54.00	-4.79	peak

802.11n20-L-V

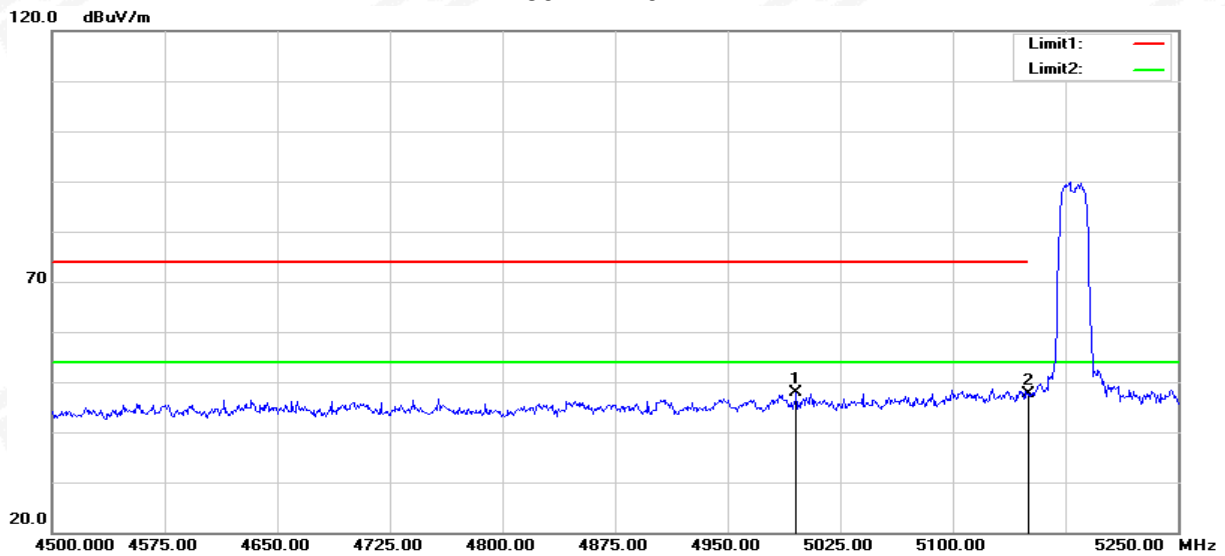

No.	Frequency (MHz)	Reading (dBuV)	Correct Factor(dB/m)	Result (dBuV/m)	Limit (dBuV/m)	Margin (dB)	Remark
1	4995.750	53.99	-6.22	47.77	54.00	-6.23	peak
2	5150.000	53.24	-5.73	47.51	54.00	-6.49	peak

802.11n20-H-H

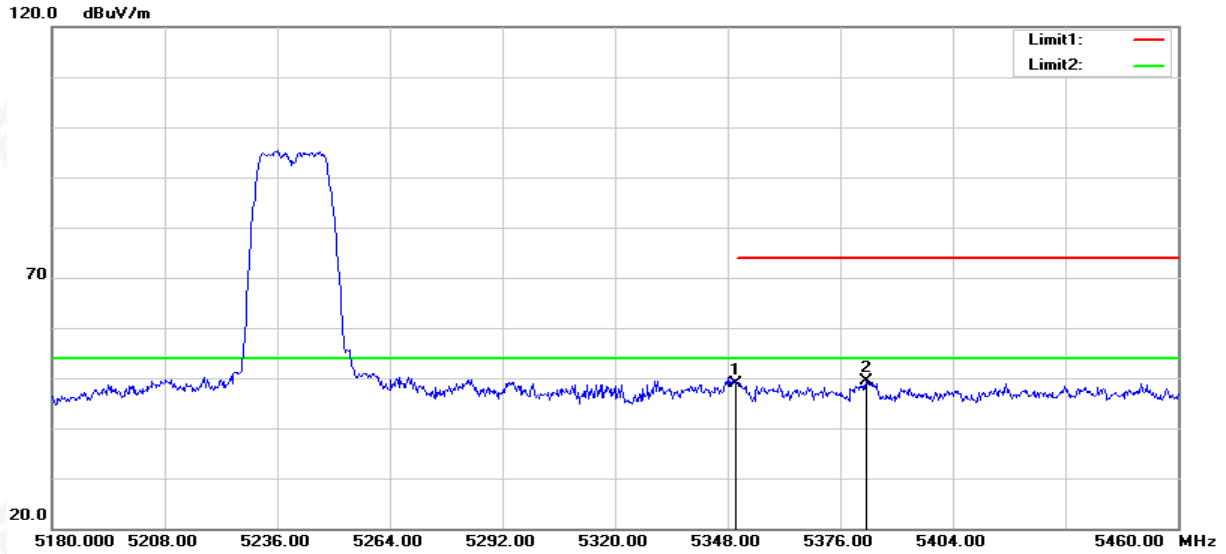

No.	Frequency (MHz)	Reading (dBuV)	Correct Factor(dB/m)	Result (dBuV/m)	Limit (dBuV/m)	Margin (dB)	Remark
1	5350.000	54.03	-5.23	48.80	54.00	-5.20	peak
2	5382.440	54.69	-5.24	49.45	54.00	-4.55	peak

802.11n20-H-V

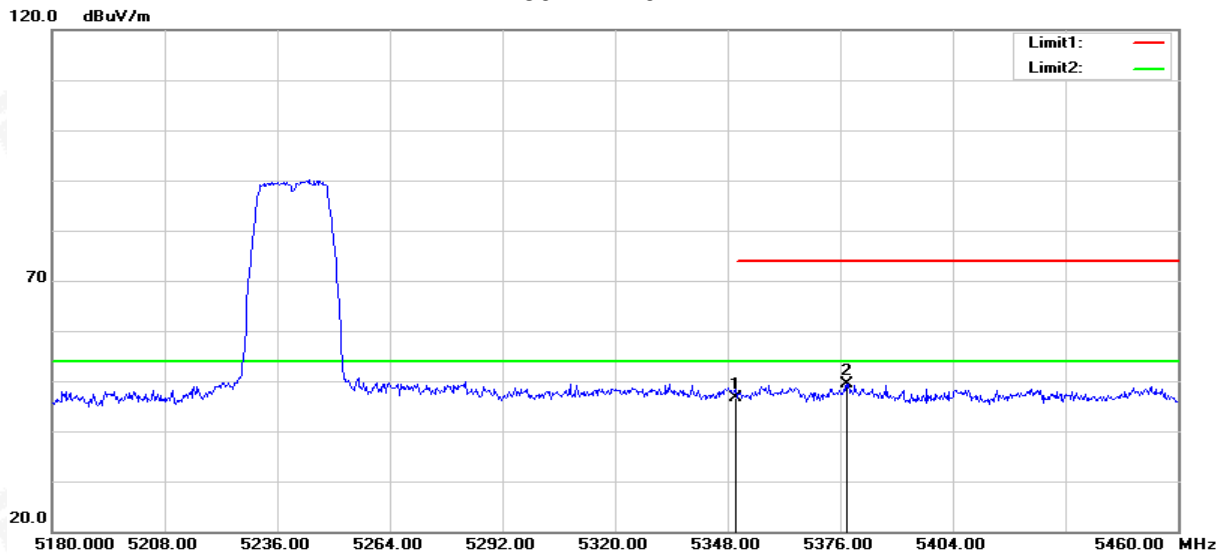

No.	Frequency (MHz)	Reading (dBuV)	Correct Factor(dB/m)	Result (dBuV/m)	Limit (dBuV/m)	Margin (dB)	Remark
1	5350.000	51.91	-5.23	46.68	54.00	-7.32	peak
2	5377.680	54.67	-5.24	49.43	54.00	-4.57	peak

802.11n40-L-H

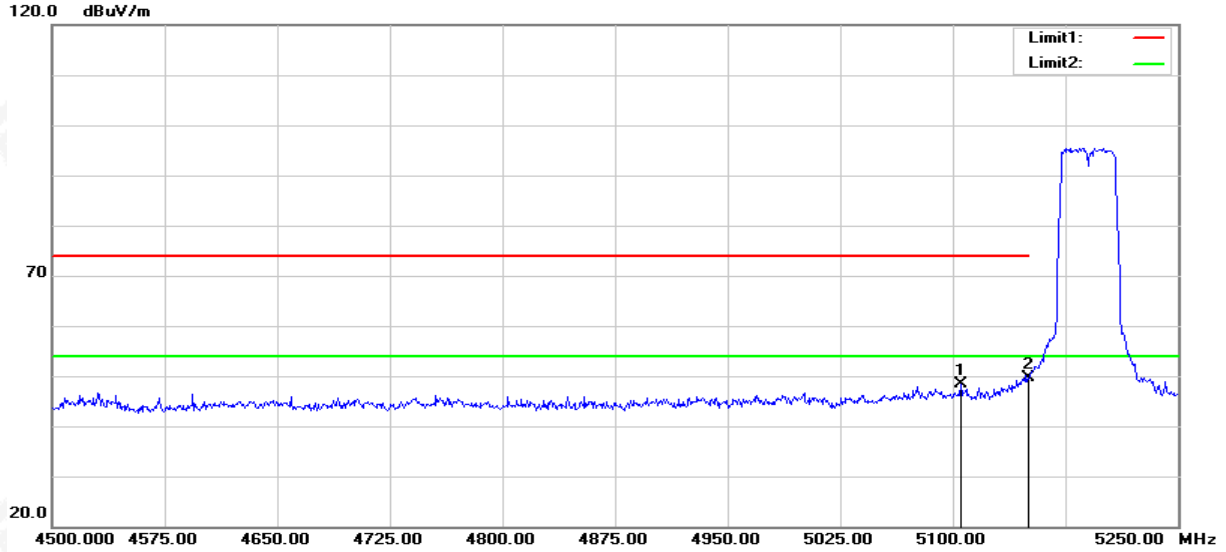

No.	Frequency (MHz)	Reading (dBuV)	Correct Factor(dB/m)	Result (dBuV/m)	Limit (dBuV/m)	Margin (dB)	Remark
1	5105.250	54.01	-5.74	48.27	54.00	-5.73	peak
2	5150.000	55.35	-5.73	49.62	54.00	-4.38	peak

802.11n40-L-V

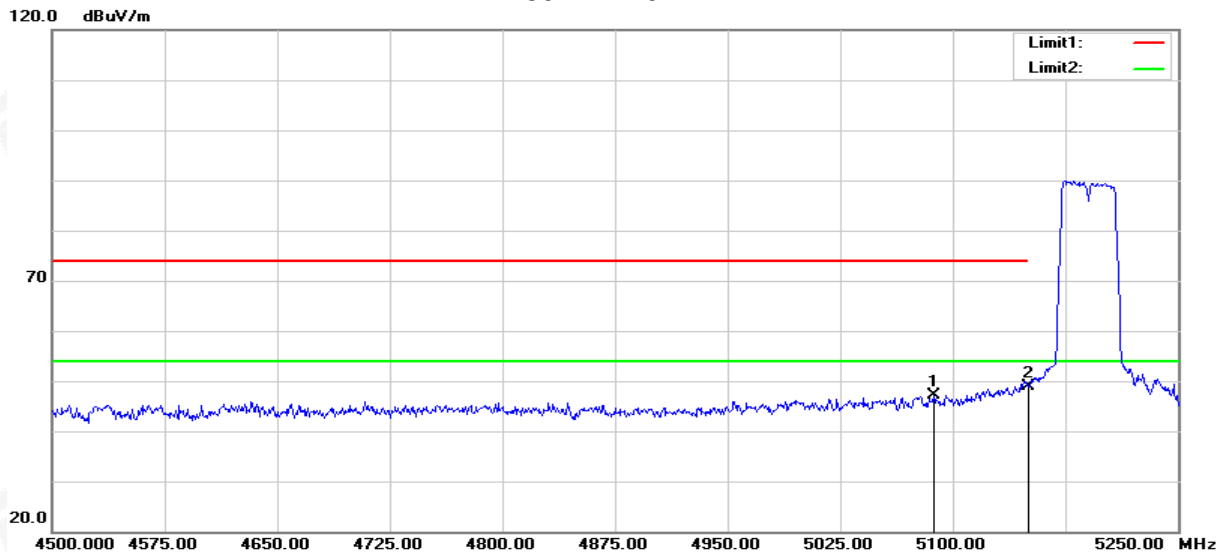

No.	Frequency (MHz)	Reading (dBuV)	Correct Factor(dB/m)	Result (dBuV/m)	Limit (dBuV/m)	Margin (dB)	Remark
1	5087.250	53.04	-5.80	47.24	54.00	-6.76	peak
2	5150.000	54.71	-5.73	48.98	54.00	-5.02	peak

802.11n40-H-H

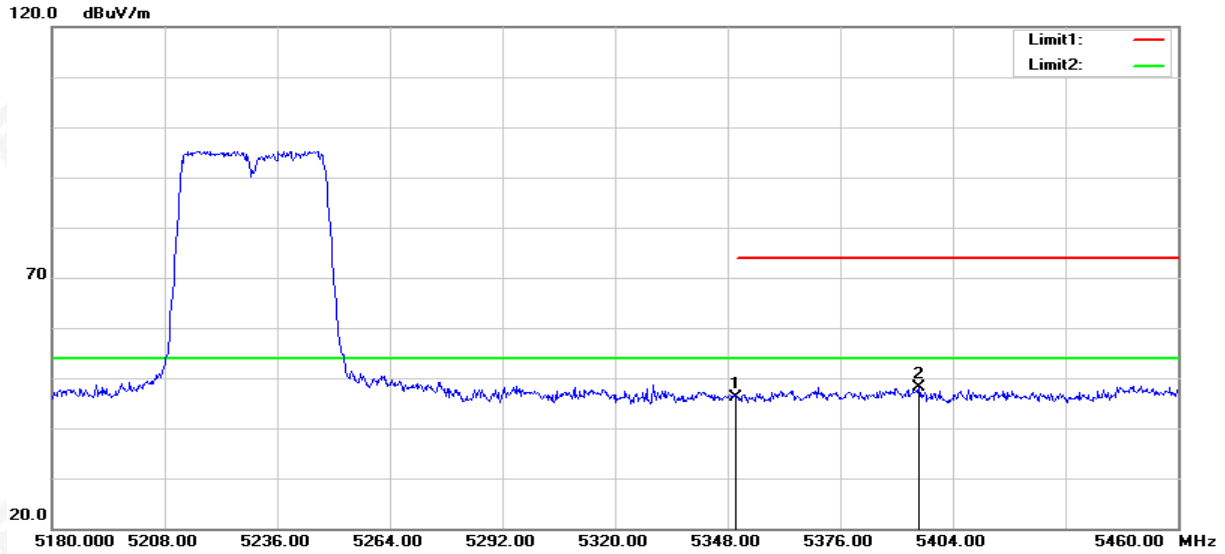

No.	Frequency (MHz)	Reading (dBuV)	Correct Factor(dB/m)	Result (dBuV/m)	Limit (dBuV/m)	Margin (dB)	Remark
1	5350.000	51.41	-5.23	46.18	54.00	-7.82	peak
2	5395.600	53.27	-5.24	48.03	54.00	-5.97	peak

802.11n40-H-V

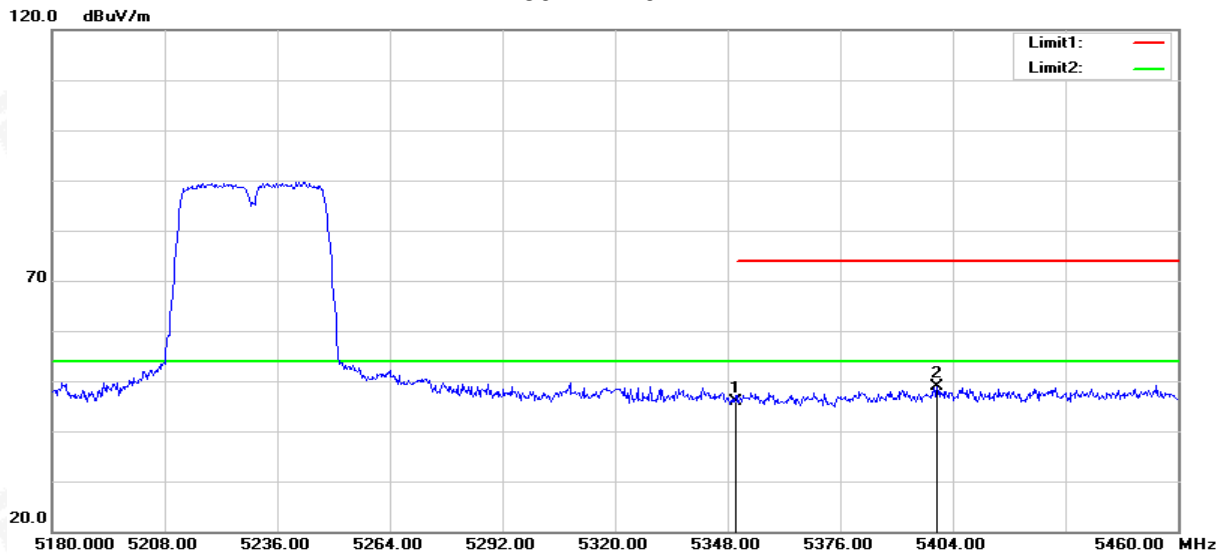

No.	Frequency (MHz)	Reading (dBuV)	Correct Factor(dB/m)	Result (dBuV/m)	Limit (dBuV/m)	Margin (dB)	Remark
1	5350.000	51.03	-5.23	45.80	54.00	-8.20	peak
2	5400.080	54.09	-5.25	48.84	54.00	-5.16	peak

Remark:

1. Factor = Antenna Factor + Cable Loss – Pre-amplifier.
2. All modes have been measurement, only worst mode was reported.

U-NII-2A 5250-5350MHz

802.11n20-L-H

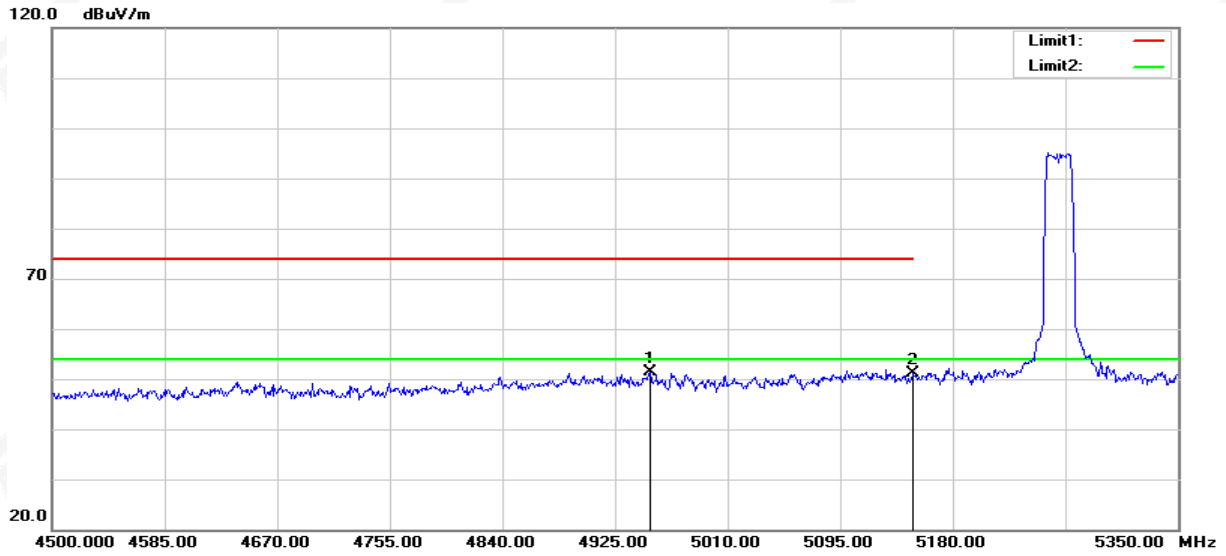

No.	Frequency (MHz)	Reading (dBuV)	Correct Factor(dB/m)	Result (dBuV/m)	Limit (dBuV/m)	Margin (dB)	Remark
1	4951.350	57.29	-6.01	51.28	54.00	-2.72	peak
2	5150.000	56.89	-5.77	51.12	54.00	-2.88	peak

802.11n20-L-V

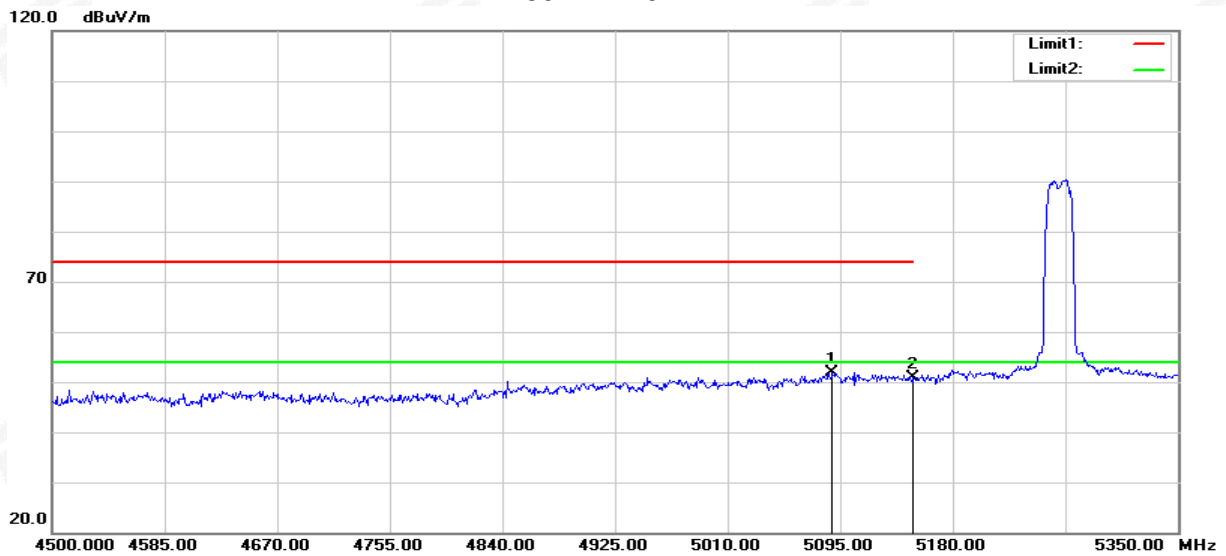

No.	Frequency (MHz)	Reading (dBuV)	Correct Factor(dB/m)	Result (dBuV/m)	Limit (dBuV/m)	Margin (dB)	Remark
1	5089.050	57.35	-5.50	51.85	54.00	-2.15	peak
2	5150.000	56.53	-5.77	50.76	54.00	-3.24	peak

802.11n20-H-H

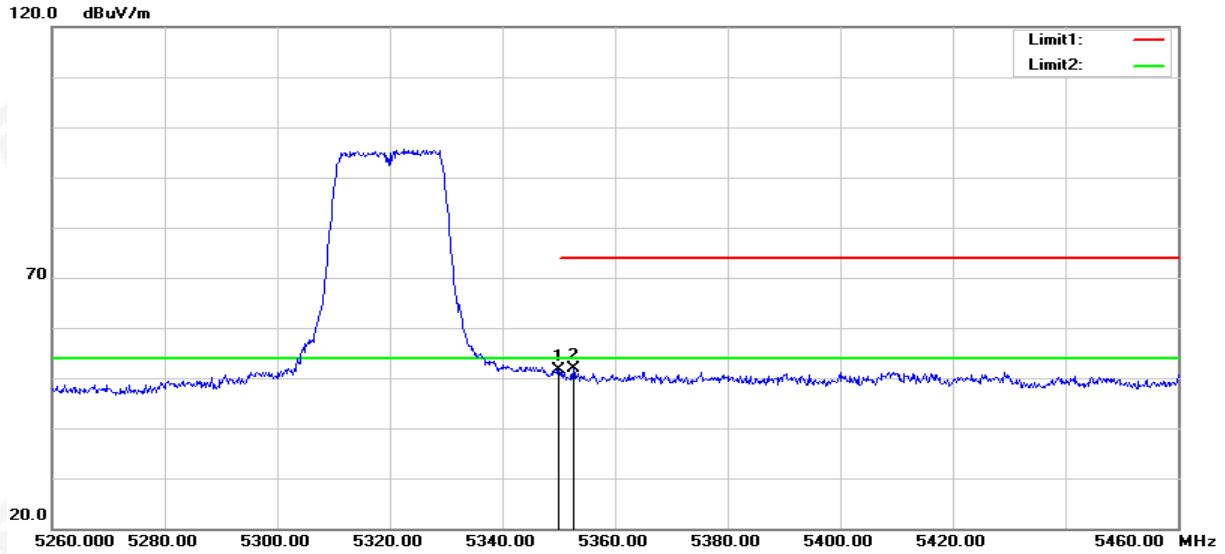

No.	Frequency (MHz)	Reading (dBuV)	Correct Factor(dB/m)	Result (dBuV/m)	Limit (dBuV/m)	Margin (dB)	Remark
1	5350.000	56.90	-5.33	51.57	54.00	-2.43	peak
2	5352.600	57.11	-5.32	51.79	54.00	-2.21	peak

802.11n20-H-V

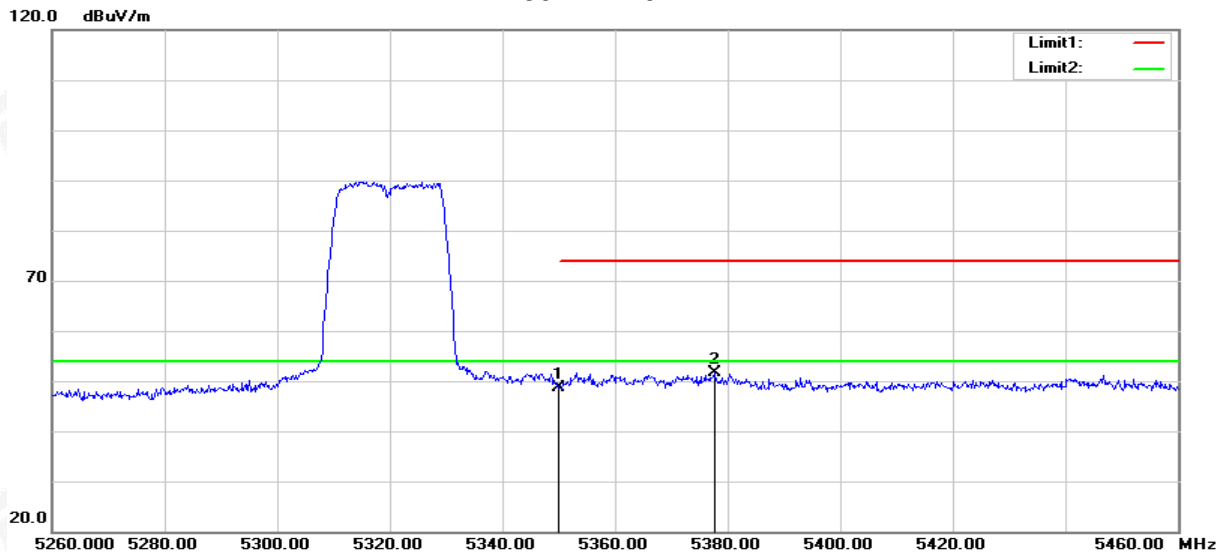

No.	Frequency (MHz)	Reading (dBuV)	Correct Factor(dB/m)	Result (dBuV/m)	Limit (dBuV/m)	Margin (dB)	Remark
1	5350.000	53.94	-5.33	48.61	54.00	-5.39	peak
2	5377.600	56.76	-5.20	51.56	54.00	-2.44	peak

802.11n40-L-H

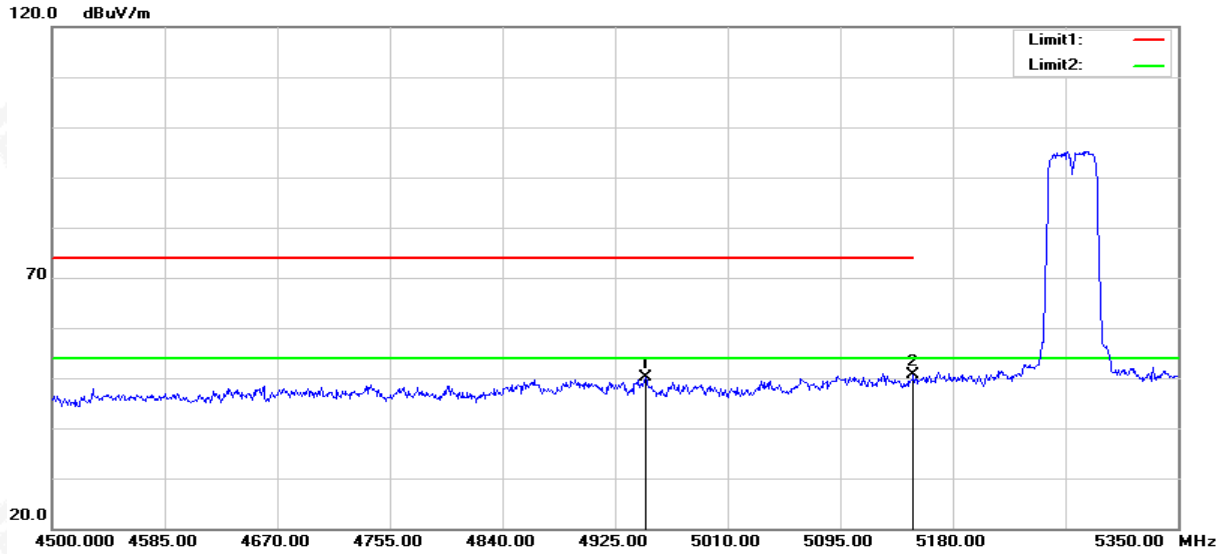

No.	Frequency (MHz)	Reading (dBuV)	Correct Factor(dB/m)	Result (dBuV/m)	Limit (dBuV/m)	Margin (dB)	Remark
1	4947.950	56.22	-6.00	50.22	54.00	-3.78	peak
2	5150.000	56.37	-5.77	50.60	54.00	-3.40	peak

802.11n40-L-V

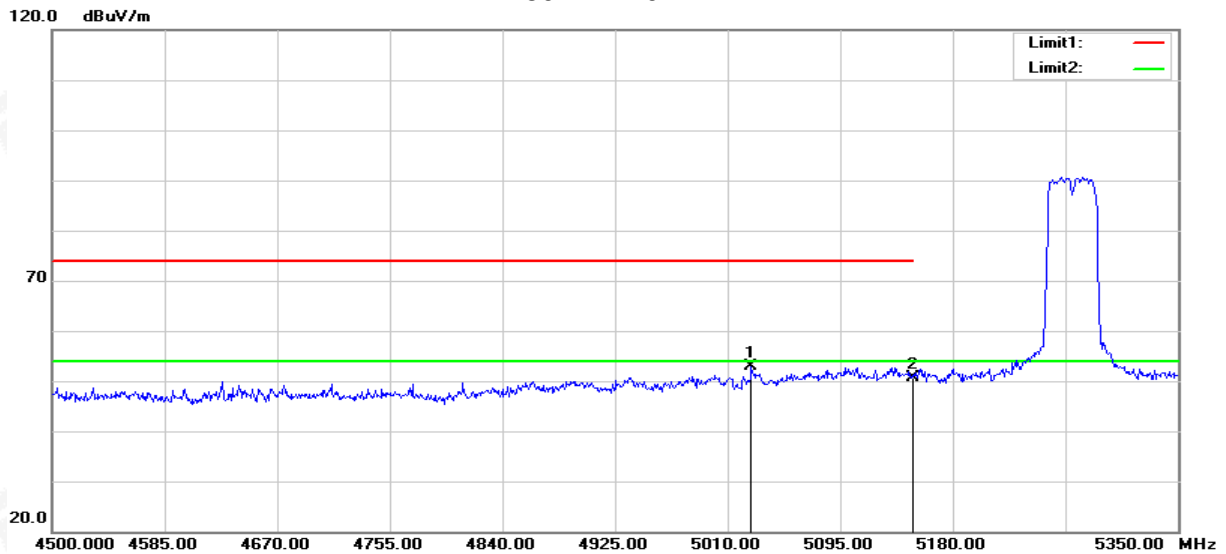

No.	Frequency (MHz)	Reading (dBuV)	Correct Factor(dB/m)	Result (dBuV/m)	Limit (dBuV/m)	Margin (dB)	Remark
1	5027.850	58.58	-5.81	52.77	54.00	-1.23	peak
2	5150.000	56.52	-5.77	50.75	54.00	-3.25	peak

802.11n40-H-H

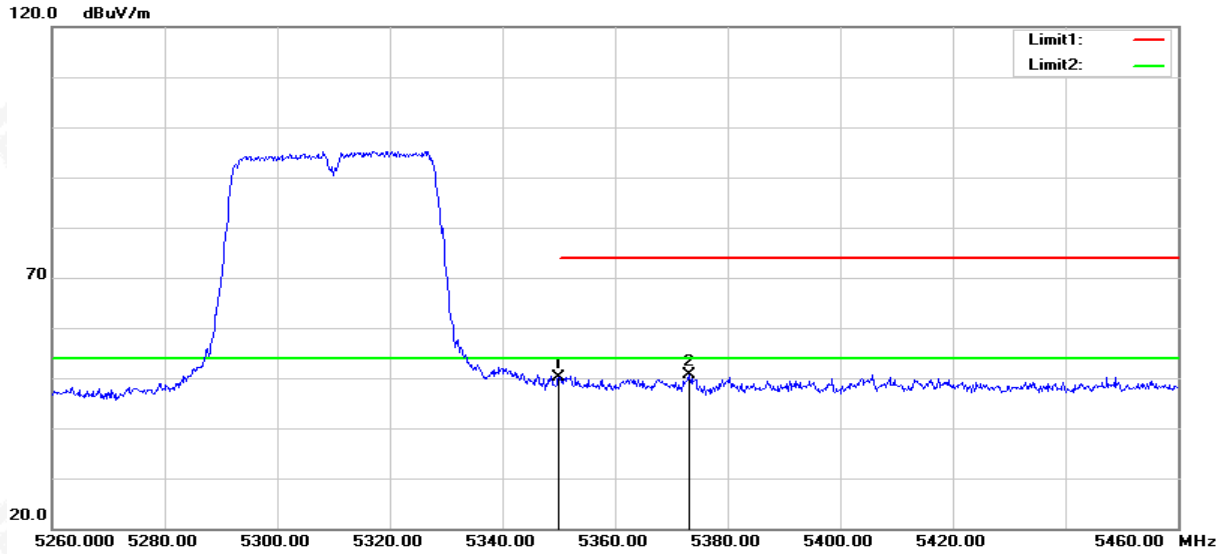

No.	Frequency (MHz)	Reading (dBuV)	Correct Factor(dB/m)	Result (dBuV/m)	Limit (dBuV/m)	Margin (dB)	Remark
1	5350.000	55.40	-5.33	50.07	54.00	-3.93	peak
2	5373.200	55.87	-5.22	50.65	54.00	-3.35	peak

802.11n40-H-V

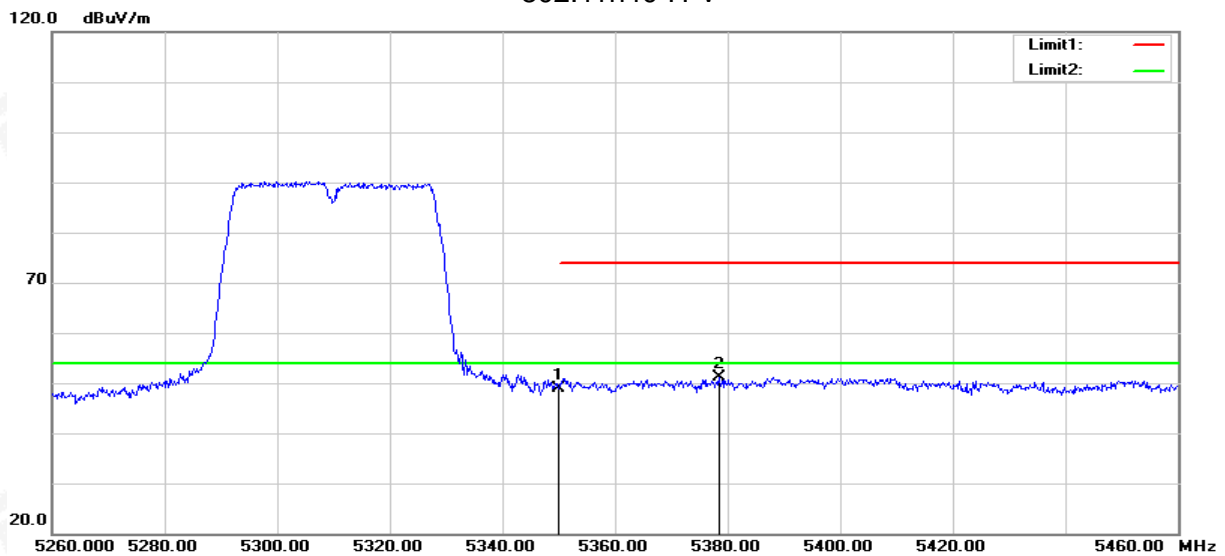

No.	Frequency (MHz)	Reading (dBuV)	Correct Factor(dB/m)	Result (dBuV/m)	Limit (dBuV/m)	Margin (dB)	Remark
1	5350.000	54.30	-5.33	48.97	54.00	-5.03	peak
2	5378.400	56.33	-5.20	51.13	54.00	-2.87	peak

Remark:

1. Factor = Antenna Factor + Cable Loss – Pre-amplifier.
2. All modes have been measurement, only worst mode was reported.

U-NII-2C 5470-5725MHz

802.11n20-L-H

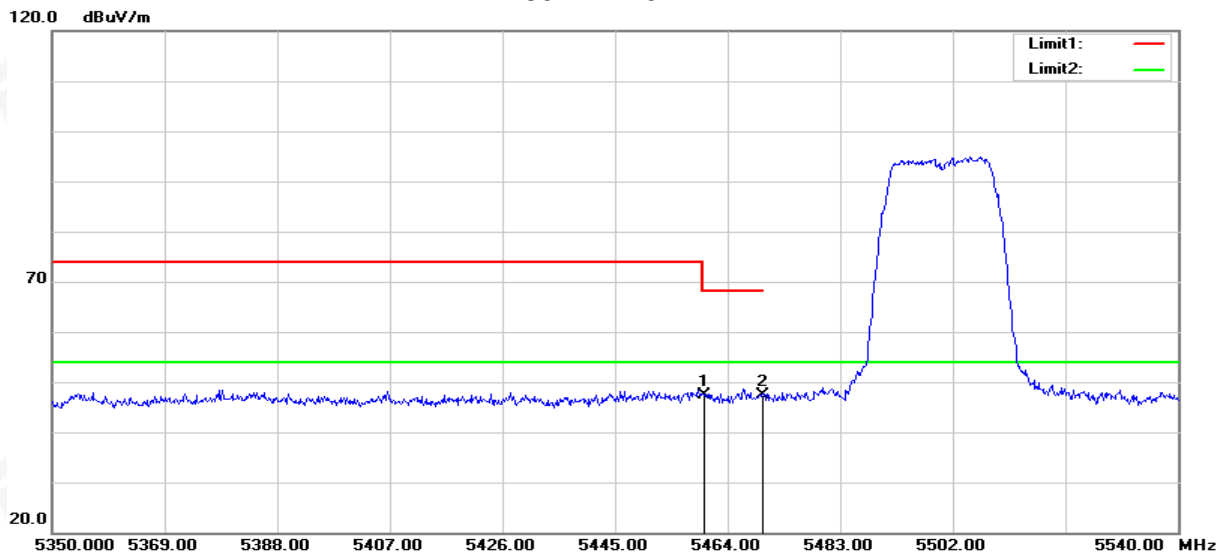

No.	Frequency (MHz)	Reading (dBuV)	Correct Factor(dB/m)	Result (dBuV/m)	Limit (dBuV/m)	Margin (dB)	Remark
1	5460.000	52.52	-5.11	47.41	68.20	-20.79	peak
2	5470.000	52.44	-5.09	47.35	68.20	-20.85	peak

802.11n20-L-V

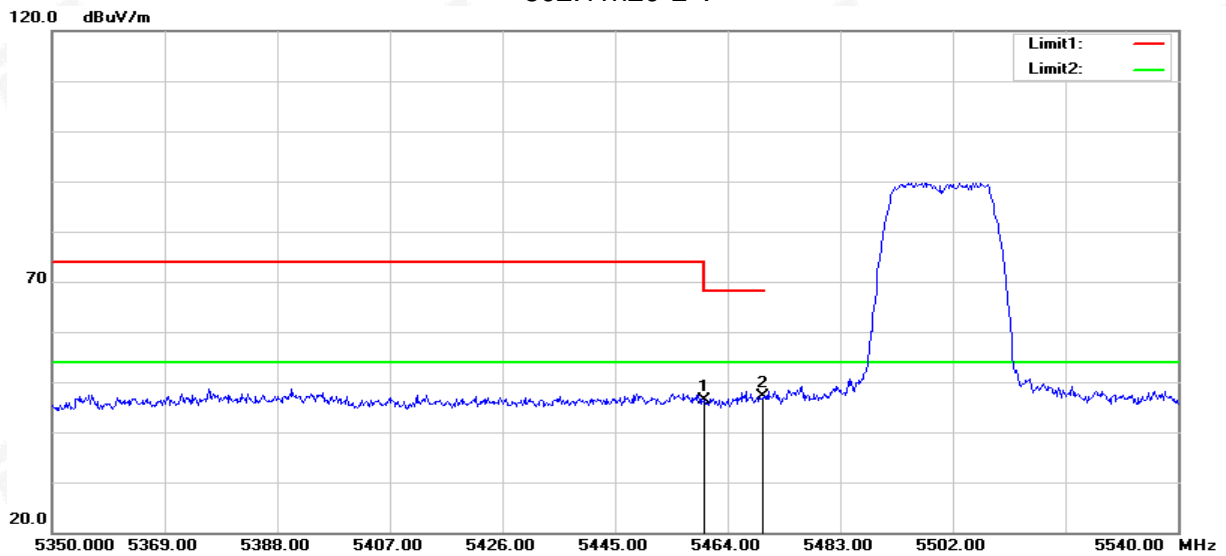

No.	Frequency (MHz)	Reading (dBuV)	Correct Factor(dB/m)	Result (dBuV/m)	Limit (dBuV/m)	Margin (dB)	Remark
1	5460.000	51.52	-5.11	46.41	68.20	-21.79	peak
2	5470.000	52.23	-5.09	47.14	68.20	-21.06	peak

802.11n20-H-H

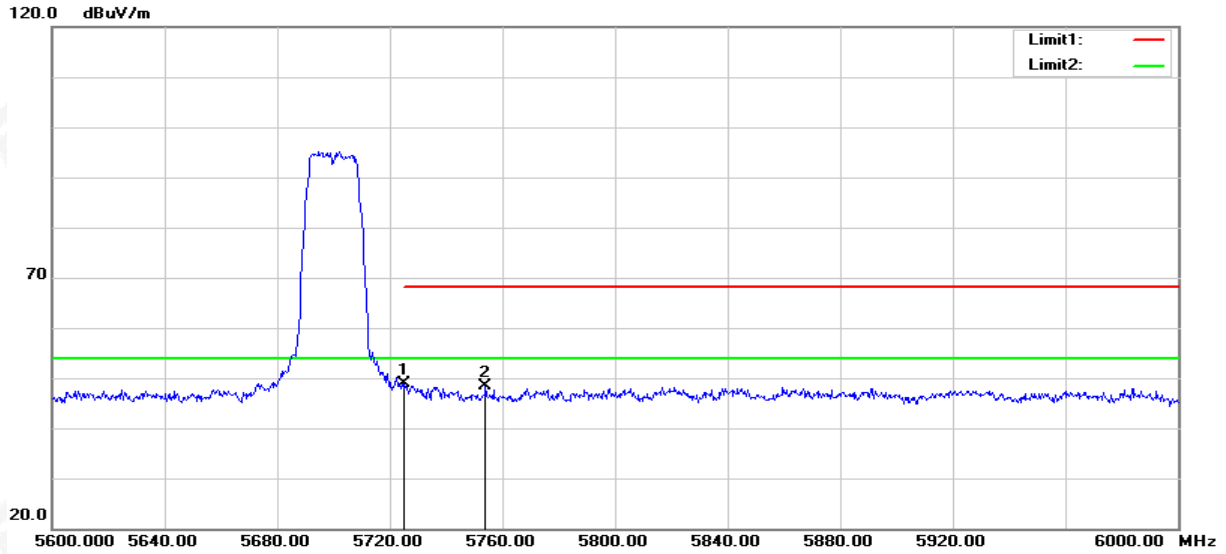

No.	Frequency (MHz)	Reading (dBuV)	Correct Factor(dB/m)	Result (dBuV/m)	Limit (dBuV/m)	Margin (dB)	Remark
1	5725.000	53.53	-4.57	48.96	68.20	-19.24	peak
2	5754.000	52.96	-4.47	48.49	68.20	-19.71	peak

802.11n20-H-V

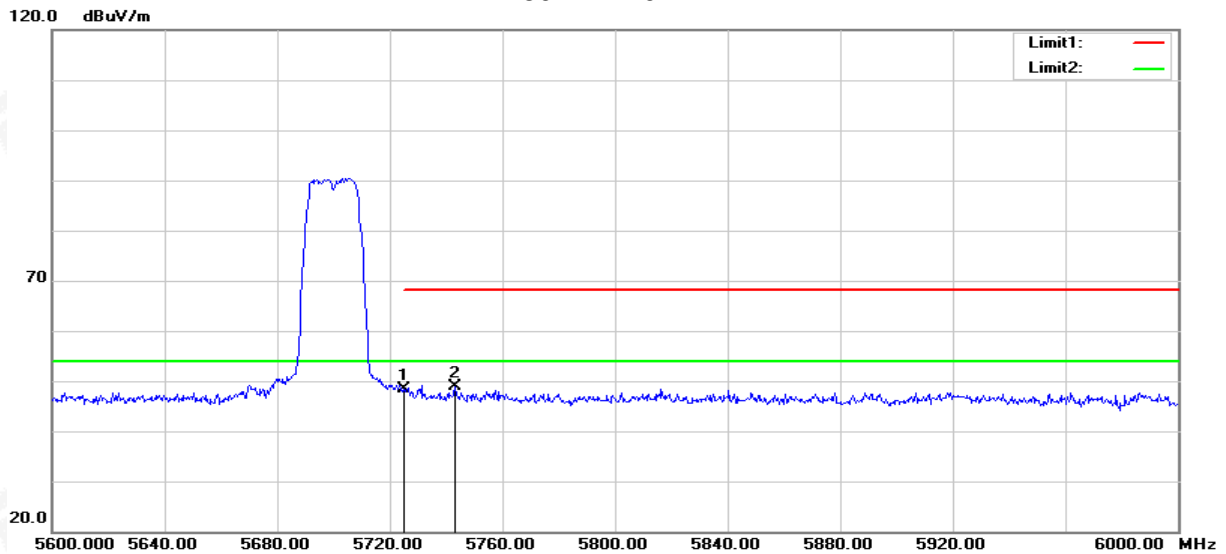

No.	Frequency (MHz)	Reading (dBuV)	Correct Factor(dB/m)	Result (dBuV/m)	Limit (dBuV/m)	Margin (dB)	Remark
1	5725.000	53.00	-4.57	48.43	68.20	-19.77	peak
2	5743.200	53.46	-4.51	48.95	68.20	-19.25	peak

802.11n40-L-H

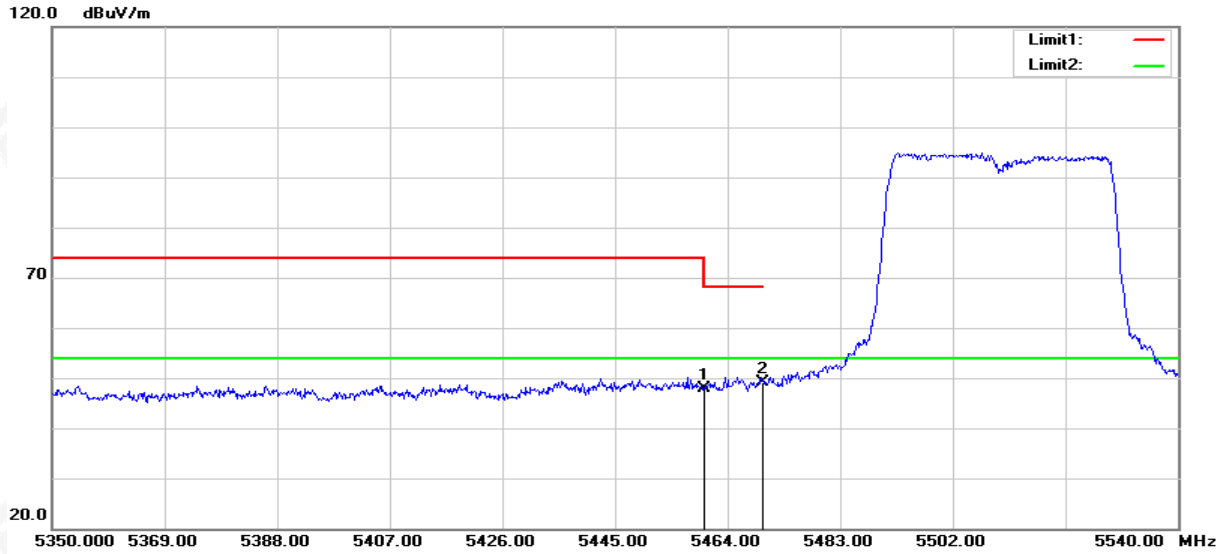

No.	Frequency (MHz)	Reading (dBuV)	Correct Factor(dB/m)	Result (dBuV/m)	Limit (dBuV/m)	Margin (dB)	Remark
1	5460.000	52.98	-5.11	47.87	68.20	-20.33	peak
2	5470.000	54.18	-5.09	49.09	68.20	-19.11	peak

802.11n40-L-V

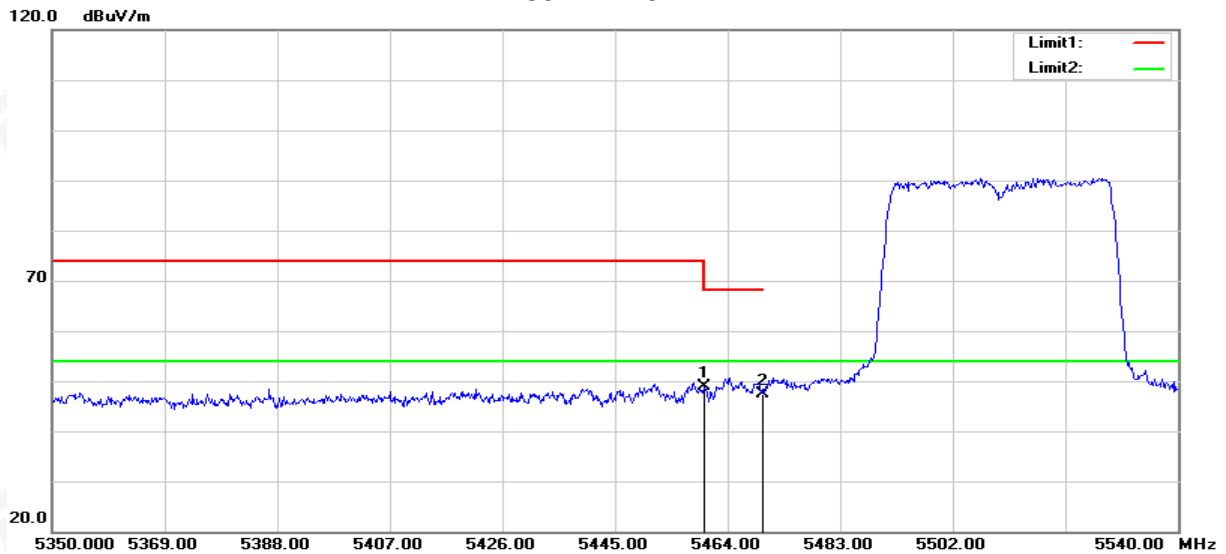

No.	Frequency (MHz)	Reading (dBuV)	Correct Factor(dB/m)	Result (dBuV/m)	Limit (dBuV/m)	Margin (dB)	Remark
1	5460.000	54.01	-5.11	48.90	68.20	-19.30	peak
2	5470.000	52.50	-5.09	47.41	68.20	-20.79	peak

802.11n40-H-H

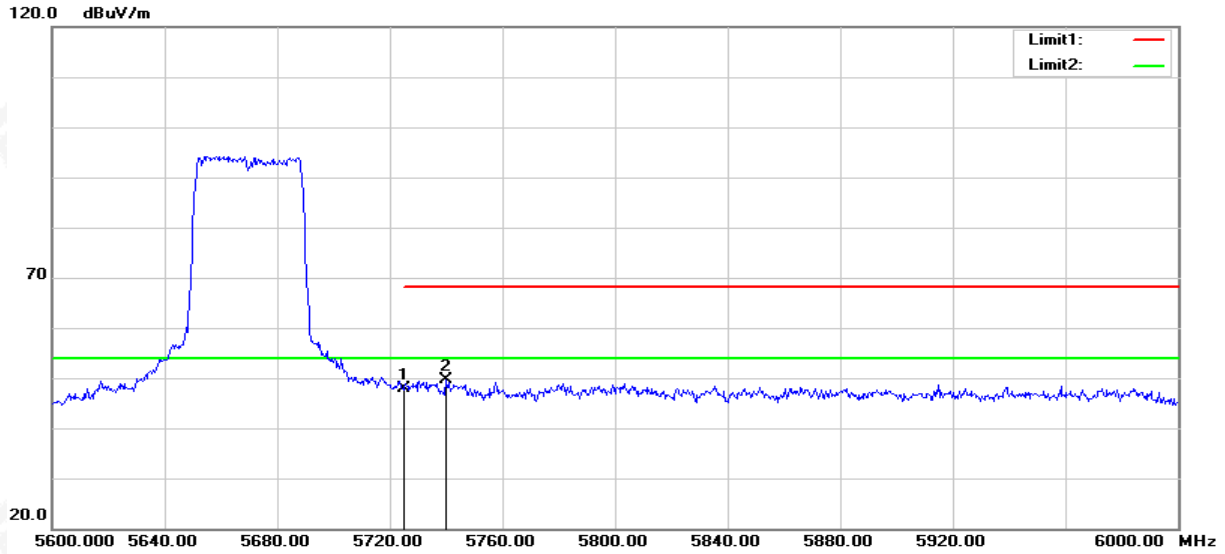

No.	Frequency (MHz)	Reading (dBuV)	Correct Factor(dB/m)	Result (dBuV/m)	Limit (dBuV/m)	Margin (dB)	Remark
1	5725.000	52.51	-4.57	47.94	68.20	-20.26	peak
2	5740.000	54.20	-4.53	49.67	68.20	-18.53	peak

802.11n40-H-V

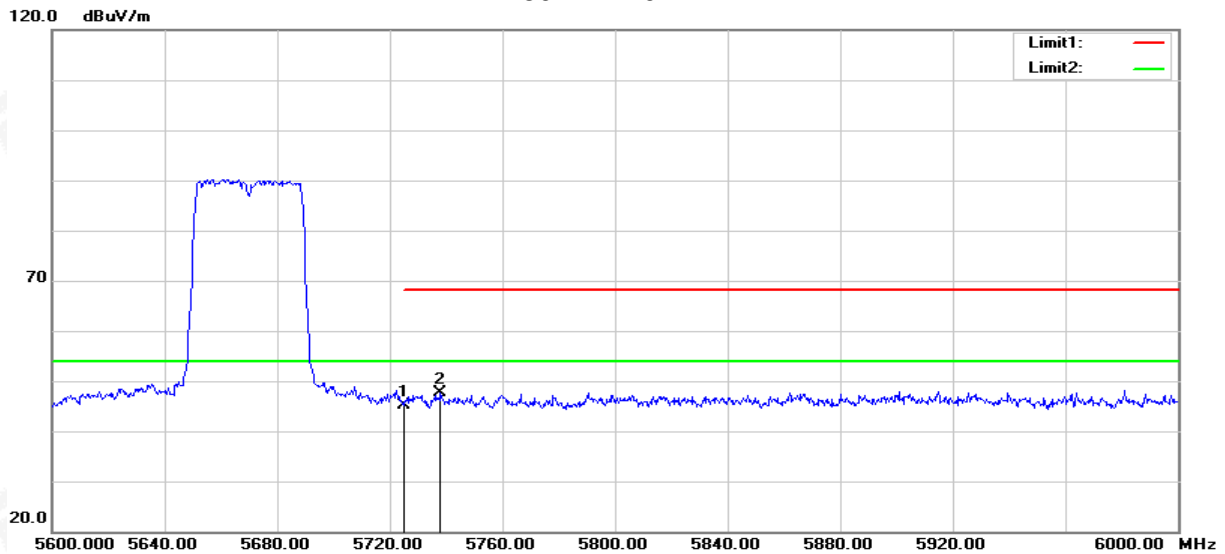

No.	Frequency (MHz)	Reading (dBuV)	Correct Factor(dB/m)	Result (dBuV/m)	Limit (dBuV/m)	Margin (dB)	Remark
1	5725.000	49.72	-4.57	45.15	68.20	-23.05	peak
2	5738.000	52.13	-4.53	47.60	68.20	-20.60	peak

Remark:

1. Factor = Antenna Factor + Cable Loss – Pre-amplifier.
2. All modes have been measurement, only worst mode was reported.

U-NII-3 (5.725-5.850) GHz

802.11a20-L-H

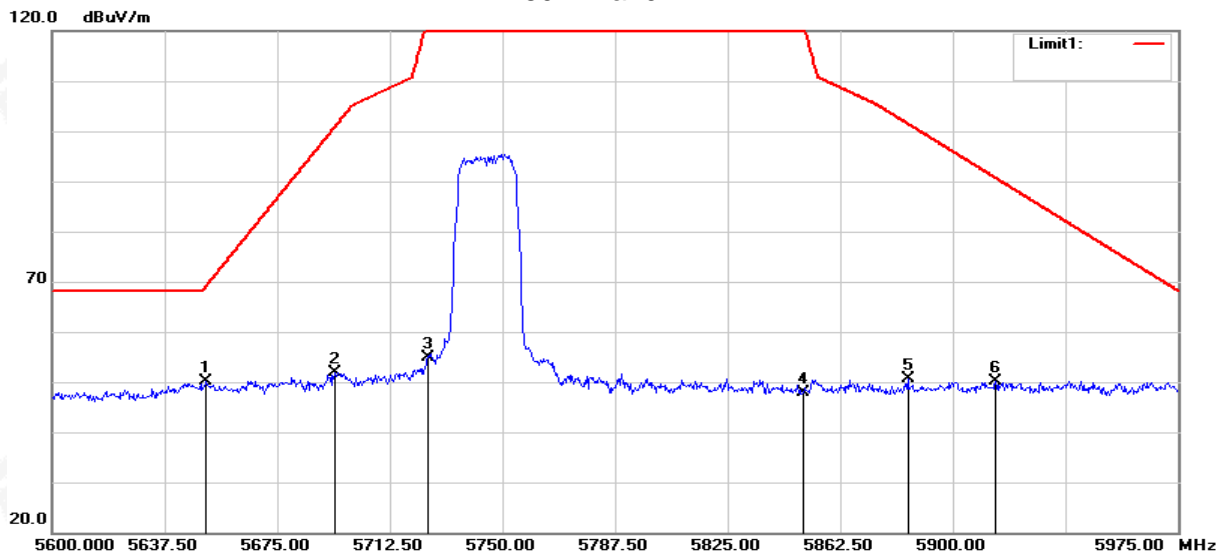

No.	Frequency (MHz)	Reading (dBuV)	Correct Factor(dB/m)	Result (dBuV/m)	Limit (dBuV/m)	Margin (dB)	Remark
1	5651.375	54.80	-4.68	50.12	69.22	-19.10	peak
2	5694.125	56.64	-4.66	51.98	100.85	-48.87	peak
3	5725.000	59.57	-4.57	55.00	122.20	-67.20	peak
4	5850.000	51.95	-4.10	47.85	122.20	-74.35	peak
5	5885.000	54.66	-3.94	50.72	101.50	-50.78	peak
6	5914.250	54.11	-3.91	50.20	90.68	-40.48	peak

802.11a20-L-V

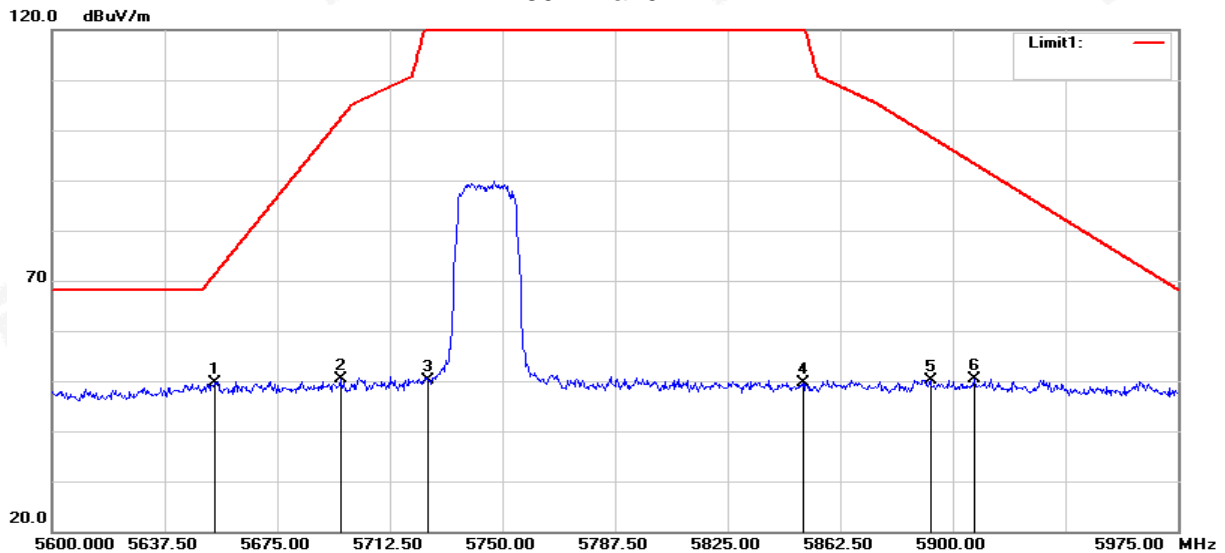

No.	Frequency (MHz)	Reading (dBuV)	Correct Factor(dB/m)	Result (dBuV/m)	Limit (dBuV/m)	Margin (dB)	Remark
1	5654.375	54.21	-4.68	49.53	71.44	-21.91	peak
2	5696.000	54.96	-4.67	50.29	102.24	-51.95	peak
3	5725.000	54.72	-4.57	50.15	122.20	-72.05	peak
4	5850.000	53.78	-4.10	49.68	122.20	-72.52	peak
5	5892.500	54.05	-3.91	50.14	98.73	-48.59	peak
6	5907.125	54.30	-3.89	50.41	93.31	-42.90	peak

802.11a20-H-H

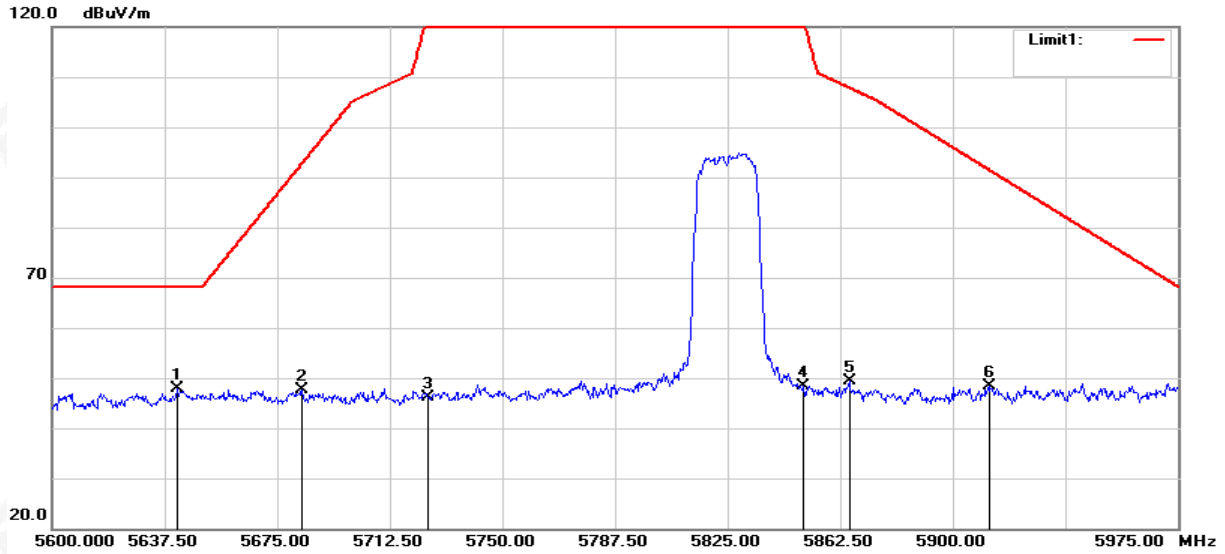

No.	Frequency (MHz)	Reading (dBuV)	Correct Factor(dB/m)	Result (dBuV/m)	Limit (dBuV/m)	Margin (dB)	Remark
1	5641.625	52.60	-4.68	47.92	68.20	-20.28	peak
2	5683.250	52.34	-4.67	47.67	92.81	-45.14	peak
3	5725.000	50.59	-4.57	46.02	122.20	-76.18	peak
4	5850.000	52.57	-4.10	48.47	122.20	-73.73	peak
5	5865.500	53.49	-4.04	49.45	107.86	-58.41	peak
6	5912.375	52.16	-3.90	48.26	91.37	-43.11	peak

802.11a20-H-V

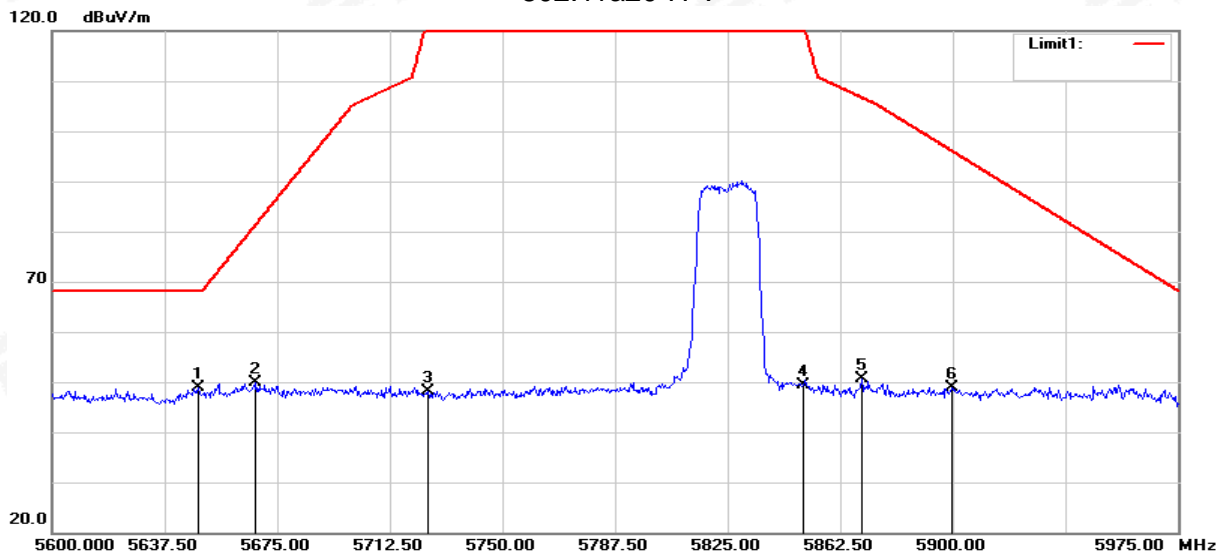

No.	Frequency (MHz)	Reading (dBuV)	Correct Factor(dB/m)	Result (dBuV/m)	Limit (dBuV/m)	Margin (dB)	Remark
1	5648.750	53.64	-4.68	48.96	68.20	-19.24	peak
2	5667.875	54.55	-4.67	49.88	81.43	-31.55	peak
3	5725.000	52.59	-4.57	48.02	122.20	-74.18	peak
4	5850.000	53.58	-4.10	49.48	122.20	-72.72	peak
5	5869.625	54.59	-4.02	50.57	106.70	-56.13	peak
6	5899.625	52.70	-3.88	48.82	96.09	-47.27	peak

802.11n40-L-H

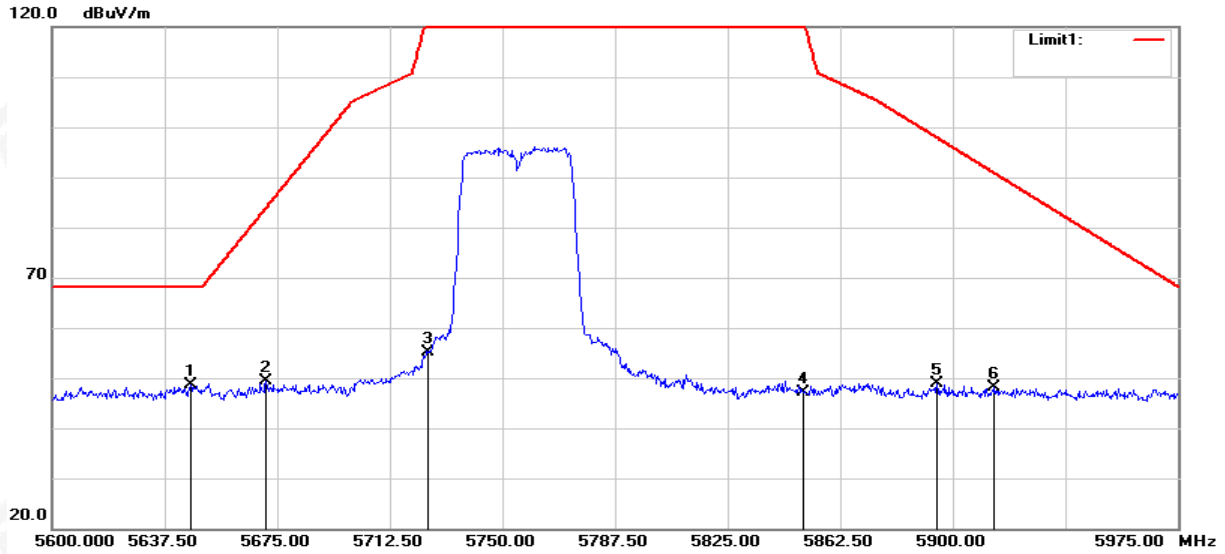

No.	Frequency (MHz)	Reading (dBuV)	Correct Factor(dB/m)	Result (dBuV/m)	Limit (dBuV/m)	Margin (dB)	Remark
1	5646.125	53.28	-4.69	48.59	68.20	-19.61	peak
2	5671.250	54.16	-4.68	49.48	83.92	-34.44	peak
3	5725.000	59.78	-4.57	55.21	122.20	-66.99	peak
4	5850.000	51.23	-4.10	47.13	122.20	-75.07	peak
5	5894.750	52.78	-3.90	48.88	97.89	-49.01	peak
6	5913.875	52.07	-3.91	48.16	90.82	-42.66	peak

802.11n40-L-V

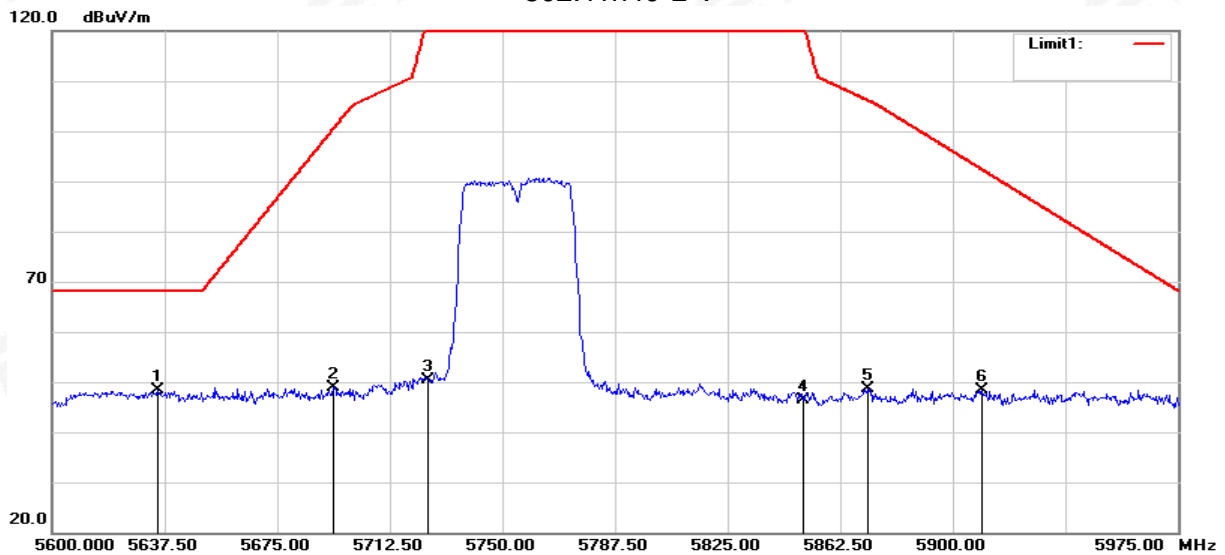

No.	Frequency (MHz)	Reading (dBuV)	Correct Factor(dB/m)	Result (dBuV/m)	Limit (dBuV/m)	Margin (dB)	Remark
1	5635.250	53.02	-4.68	48.34	68.20	-19.86	peak
2	5693.750	53.45	-4.66	48.79	100.58	-51.79	peak
3	5725.000	54.83	-4.57	50.26	122.20	-71.94	peak
4	5850.000	50.46	-4.10	46.36	122.20	-75.84	peak
5	5871.500	52.76	-4.01	48.75	106.18	-57.43	peak
6	5909.750	52.25	-3.89	48.36	92.34	-43.98	peak

802.11n40-H-H

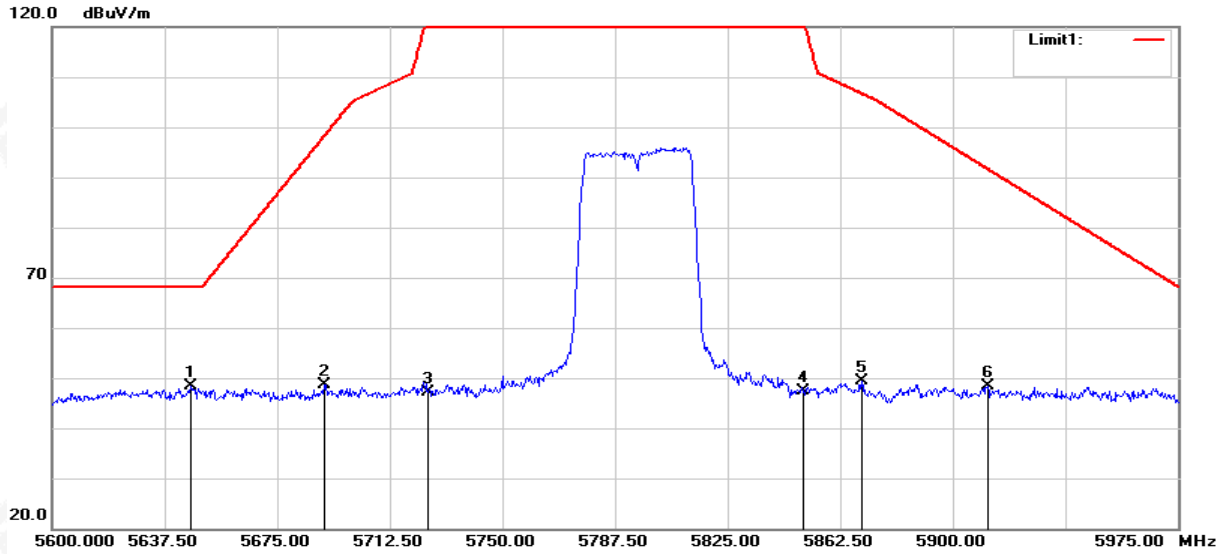

No.	Frequency (MHz)	Reading (dBuV)	Correct Factor(dB/m)	Result (dBuV/m)	Limit (dBuV/m)	Margin (dB)	Remark
1	5646.125	53.00	-4.69	48.31	68.20	-19.89	peak
2	5690.750	53.31	-4.66	48.65	98.36	-49.71	peak
3	5725.000	51.58	-4.57	47.01	122.20	-75.19	peak
4	5850.000	51.37	-4.10	47.27	122.20	-74.93	peak
5	5869.625	53.33	-4.02	49.31	106.70	-57.39	peak
6	5911.625	52.19	-3.90	48.29	91.65	-43.36	peak

802.11n40-H-V

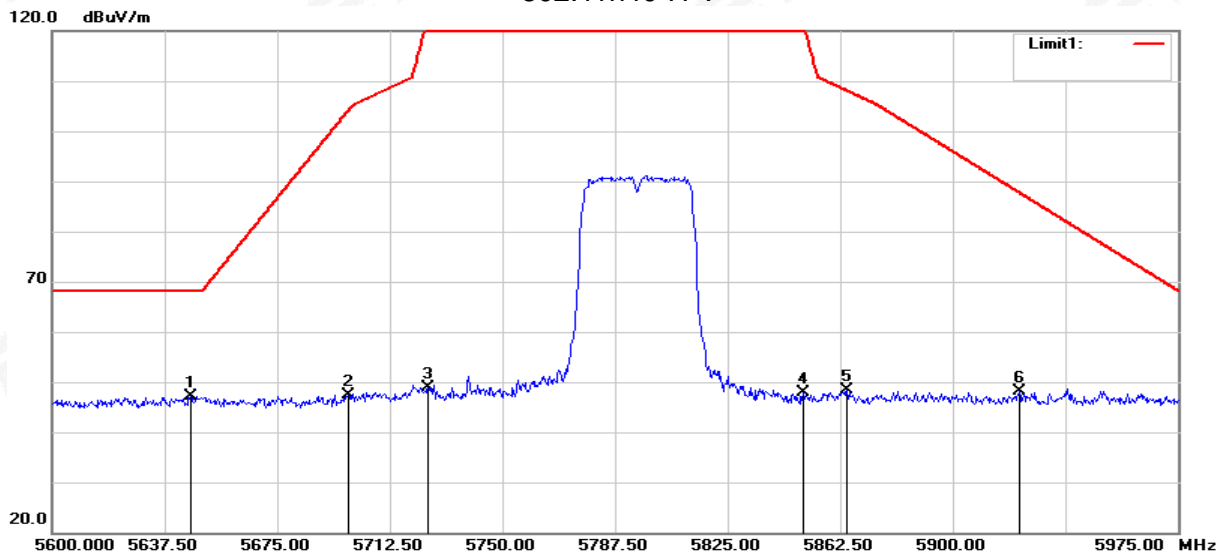

No.	Frequency (MHz)	Reading (dBuV)	Correct Factor(dB/m)	Result (dBuV/m)	Limit (dBuV/m)	Margin (dB)	Remark
1	5646.125	51.76	-4.69	47.07	68.20	-21.13	peak
2	5698.625	52.12	-4.66	47.46	104.18	-56.72	peak
3	5725.000	53.48	-4.57	48.91	122.20	-73.29	peak
4	5850.000	51.93	-4.10	47.83	122.20	-74.37	peak
5	5864.750	52.49	-4.04	48.45	108.07	-59.62	peak
6	5922.125	51.98	-3.91	48.07	87.76	-39.69	peak

Remark:

1. Factor = Antenna Factor + Cable Loss – Pre-amplifier.
2. All modes have been measurement, only worst mode was reported.

4. POWER SPECTRAL DENSITY TEST

4.1 LIMIT

1. For mobile and portable client devices in the 5.15-5.25 GHz band, , the maximum power spectral density shall not exceed 11 dBm in any 1 megahertz band. If transmitting antennas of directional gain greater than 6 dBi are used, both the maximum conducted output power and the maximum power spectral density shall be reduced by the amount in dB that the directional gain of the antenna exceeds 6 dBi.
2. For the 5.25-5.35 GHz and 5.47-5.725 GHz bands, the maximum power spectral density shall not exceed 11 dBm in any 1 megahertz band. If transmitting antennas of directional gain greater than 6 dBi are used, both the maximum conducted output power and the maximum power spectral density shall be reduced by the amount in dB that the directional gain of the antenna exceeds 6 dBi.
3. For the band 5.725-5.850 GHz, the peak power spectral density shall not exceed 30 dBm in any 500kHz band. If transmitting antenna directional gain is greater than 6 dBi, both the maximum conducted output power and the peak power spectral density shall be reduced by the amount in dB that the directional gain of the antenna exceeds 6 dBi.

4.2 TEST PROCEDURE

1. The setting follows Method SA-1 of FCC KDB 789033 D02 General U-NII Test Procedures New Rules v02r01.

For devices operating in the band, the rules specify a measurement bandwidth of 500 kHz. Many spectrum analyzers do not have 500 kHz RBW, thus a narrower RBW may need to be used. The rules permit the use of a RBWs less than 1 MHz, or 500 kHz, "provided that the measured power is integrated over the full reference bandwidth" to show the total power over the specified measurement bandwidth (*i.e.*, 1 MHz, or 500 kHz). If measurements are performed using a reduced resolution bandwidth (< 1 MHz, or < 500 kHz) and integrated over 1 MHz, or 500 KHz bandwidth, the following adjustments to the procedures apply:

- a) Set $RBW \geq 1/T$, where T is defined in section II.B.I.a).
- b) Set $VBW \geq 3 RBW$.
- c) If measurement bandwidth of Maximum PSD is specified in 500 kHz, add $10 \log (500\text{kHz}/RBW)$ to the measured result, whereas $RBW (< 500 \text{ kHz})$ is the reduced resolution bandwidth of the spectrum analyzer set during measurement.
- d) If measurement bandwidth of Maximum PSD is specified in 1 MHz, add $10 \log (1\text{MHz}/RBW)$ to the measured result, whereas $RBW (< 1 \text{ MHz})$ is the reduced resolution bandwidth of spectrum analyzer set during measurement.
- e) Care must be taken to ensure that the measurements are performed during a period of continuous transmission or are corrected upward for duty cycle.

Note: As a practical matter, it is recommended to use reduced RBW of 100 kHz for the sections 5.c) and 5.d) above, since $RBW=100 \text{ KHZ}$ is available on nearly all spectrum analyzers.

4.3 DEVIATION FROM STANDARD

No deviation.

4.4 TEST SETUP



4.5 EUT OPERATION CONDITIONS

The EUT tested system was configured as the statements of 2.1 Unless otherwise a special operating condition is specified in the follows during the testing.

4.6 TEST RESULTS

Note: The test data please reference to attachment "STS2508081W04_Appendix 5G WIFI".

5. BANDWIDTH MEASUREMENT

5.1 EMISSION BANDWIDTH (EBW) 26 BANDWID PROCEDURES / LIMIT

The following procedure shall be used for measuring 26 bandwidth

5.1.1 TEST PROCEDURE

1. The testing follows FCC KDB 789033 D02 General UNII Test Procedures New Rules v02r01.
2. Set RBW = approximately 1% of the emission bandwidth.
3. Set the VBW \geq RBW.
4. Detector = Peak.
5. Trace mode = max hold.
6. Measure the maximum width of the emission that is 26 dB down from the peak of the emission. Compare this with the RBW setting of the analyzer. Readjust RBW and repeat measurement as needed until the RBW/EBW ratio is approximately 1%.

5.1.2 DEVIATION FROM STANDARD

No deviation.

5.1.3 TEST SETUP



5.1.4 EUT OPERATION CONDITIONS

The EUT tested system was configured as the statements of 2.4 Unless otherwise a special operating condition is specified in the follows during the testing.

5.1.5 TEST RESULTS

Note: The test data please reference to attachment "STS2508081W04_Appendix 5G WIFI".

5.2 OCCUPIED BANDWIDTH (99%) TEST APPLIED PROCEDURES / LIMIT

The following procedure shall be used for measuring (99 %) power bandwidth.

5.2.1 TEST PROCEDURE

1. The testing follows FCC KDB 789033 D02 General UNII Test Procedures v02r01.

The following procedure shall be used for measuring (99 %) power bandwidth:

1. Set center frequency to the nominal EUT channel center frequency.
2. Set span = 1.5 times to 5.0 times the OBW.
3. Set RBW = 1 % to 5 % of the OBW
4. Set VBW $\geq 3 \cdot$ RBW
5. Video averaging is not permitted. Where practical, a sample detection and single sweep mode shall be used. Otherwise, peak detection and max hold mode (until the trace stabilizes) shall be used.
6. Use the 99 % power bandwidth function of the instrument (if available).
7. If the instrument does not have a 99 % power bandwidth function, the trace data points are recovered and directly summed in power units. The recovered amplitude data points, beginning at the lowest frequency, are placed in a running sum until 0.5 % of the total is reached; that frequency is recorded as the lower frequency. The process is repeated until 99.5 % of the total is reached; that frequency is recorded as the upper frequency. The 99% occupied bandwidth is the difference between these two frequencies.

5.2.2 DEVIATION FROM STANDARD

No deviation.

5.2.3 TEST SETUP

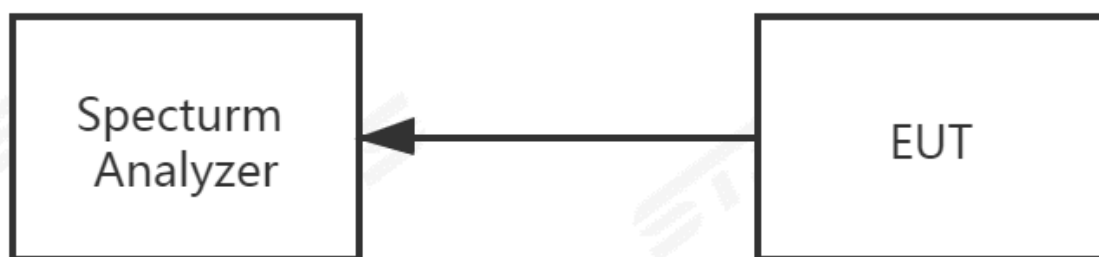

5.2.4 EUT OPERATION CONDITIONS

The EUT tested system was configured as the statements of 2.4 Unless otherwise a special operating condition is specified in the follows during the testing.

5.2.5 TEST RESULTS

Note: The test data please reference to attachment "STS2508081W04_Appendix 5G WIFI".

5.3 MINIMUM EMISSION BANDWIDTH(6 DB) PROCEDURES / LIMIT

Section 15.407(e) specifies the minimum 6 dB emission bandwidth of at least 500 KHz for the band 5.725-5.85 GHz. The following procedure shall be used for measuring this bandwidth.

5.3.1 TEST PROCEDURE

1. The testing follows FCC KDB 789033 D02 General UNII Test Procedures v02r01.

- a) Set RBW = 100 kHz.
- b) Set the video bandwidth (VBW) $\geq 3 \times$ RBW.
- c) Detector = Peak.
- d) Trace mode = max hold.
- e) Sweep = auto couple.
- f) Allow the trace to stabilize.
- g) Measure the maximum width of the emission that is constrained by the frequencies associated with the two outermost amplitude points (upper and lower frequencies) that are attenuated by 6 dB relative to the maximum level measured in the fundamental emission.

5.3.2 DEVIATION FROM STANDARD

No deviation.

5.3.3 TEST SETUP



5.3.4 EUT OPERATION CONDITIONS

The EUT tested system was configured as the statements of 2.4 Unless otherwise a special operating condition is specified in the follows during the testing.

5.3.5 TEST RESULTS

Note: The test data please reference to attachment "STS2508081W04_Appendix 5G WIFI".

6. MAXIMUM OUTPUT POWER

6.1 LIMIT

For mobile and portable client devices in the 5.15-5.25 GHz band, the maximum conducted output power over the frequency band of operation shall not exceed 250 mW provided the maximum antenna gain does not exceed 6 dBi. If transmitting antennas of directional gain greater than 6 dBi are used, both the maximum conducted output power and the maximum power spectral density shall be reduced by the amount in dB that the directional gain of the antenna exceeds 6 dBi.

For the 5.25-5.35 GHz and 5.47-5.725 GHz bands, the maximum conducted output power over the frequency bands of operation shall not exceed the lesser of 250 mW or 11 dBm + 10 log B, where B is the 26 dB emission bandwidth in megahertz, if transmitting antennas of directional gain greater than 6 dBi are used.

For the band 5.725-5.85 GHz, the maximum conducted output power over the frequency band of operation shall not exceed 1 W. If transmitting antennas of directional gain greater than 6 dBi are used.

FCC Part15 (15.407) , Subpart E				
Section	Test Item	Limit	Frequency Range (MHz)	Result
15.407(a) (1) (iv)	Max Output Power	0.25 watt	5150-5250	PASS
		The lesser of 250 mW or 11 dBm + 10 log (26 dB emission bandwidth)	5250-5350 5470-5725	
		1 watt	5725-5895	
15.407(a) (3)				

6.2 TEST PROCEDURE

The EUT was directly connected to the Power Sensor&PC

6.3 DEVIATION FROM STANDARD

No deviation.

6.4 TEST SETUP

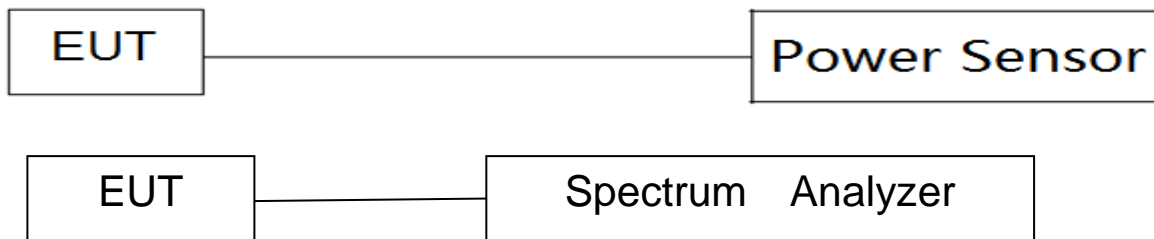

6.5 EUT OPERATION CONDITIONS

The EUT tested system was configured as the statements of 5 Unless otherwise a special operating condition is specified in the follows during the testing.

6.6 TEST RESULTS

Note: The test data please reference to attachment "STS2508081W04_Appendix 5G WIFI".

7. AUTOMATICALLY DISCONTINUE TRANSMISSION

7.1 LIMIT OF AUTOMATICALLY DISCONTINUE TRANSMISSION

The device shall automatically discontinue transmission in case of either absence of information to transmit or operational failure. These provisions are not intended to preclude the transmission of control or signaling information or the use of repetitive codes used by certain digital technologies to complete frame or burst intervals. Applicants shall include in their application for equipment authorization to describe how this requirement is met.

7.2 TEST RESULT OF AUTOMATICALLY DISCONTINUE TRANSMISSION

During no any information transmission, the EUT can automatically discontinue transmission and become standby mode for power saving. The EUT can detect the controlling signal of ACK message transmitting from remote device and verify whether it shall resend or discontinue transmission

8. ANTENNA REQUIREMENT

8.1 STANDARD REQUIREMENT

15.203 requirement: For intentional device, according to 15.203: an intentional radiator shall be designed to ensure that no antenna other than that furnished by the responsible party shall be used with the device.

8.2 EUT ANTENNA

The EUT antenna is PIFA Antenna. It comply with the standard requirement.



APPENDIX - PHOTOS OF TEST SETUP

Note: See test photos in setup photo document for the actual connections between Product and support equipment.

*****END OF THE REPORT*****